

به نام خدا



مرکز دانلود رایگان  
مهندسی متالورژی و مواد

[www.Iran-mavad.com](http://www.Iran-mavad.com)



# Handbook of Extractive Metallurgy

Edited by Fathi Habashi

Volume III: Precious Metals  
Refractory Metals  
Scattered Metals  
Radioactive Metals  
Rare Earth Metals

 WILEY-VCH

Weinheim · Chichester · New York · Toronto · Brisbane · Singapore

Professor Fathi Habashi  
Université Laval  
Département de Mines et de Métallurgie  
Québec G1K 7P4  
Canada

This book was carefully produced. Nevertheless, the editor, the authors and publisher do not warrant the information contained therein to be free of errors. Readers are advised to keep in mind that statements, data, illustrations, procedural details or other items may inadvertently be inaccurate.

Editorial Directors: Karin Sora, Ilse Bedrich  
Production Manager: Peter J. Biel  
Cover Illustration: Michel Meyer/mmada

Library of Congress Card No. applied for  
A CIP catalogue record for this book is available from the British Library

Die Deutsche Bibliothek – CIP-Einheitsaufnahme  
**Handbook of extractive metallurgy** / ed. by Fathi Habashi. –  
Weinheim ; New York ; Chichester ; Brisbane ; Singapore ; Toronto :  
WILEY-VCH ISBN 3-527-28792-2

Vol. 1. The metal industry, ferrous metals. – 1997

Vol. 2. Primary metals, secondary metals, light metals. – 1997

Vol. 3. Precious metals, refractory metals, scattered metals, radioactive metals, rare earth metals. – 1997

Vol. 4. Ferrous alloy metals, alkali metals, alkaline earth metals; Name index; Subject index. – 1997

© VCH Verlagsgesellschaft mbH – A Wiley company,  
D-69451 Weinheim, Federal Republic of Germany, 1997

Printed on acid-free and low-chlorine paper

All rights reserved (including those of translation into other languages). No part of this book may be reproduced in any form – by photoprinting, microfilm, or any other means – nor transmitted or translated into a machine language without written permission from the publishers. Registered names, trademarks, etc. used in this book, even when not specifically marked as such, are not to be considered unprotected by law.

Composition: Jean François Morin, Québec, Canada  
Printing: Strauss Offsetdruck GmbH, D-69509 Mörlenbach  
Bookbinding: Wilhelm Oswald & Co., D-67433 Neustadt/Weinstraße

Printed in the Federal Republic of Germany

## Preface

Extractive metallurgy is that branch of metallurgy that deals with ores as raw material and metals as finished products. It is an ancient art that has been transformed into a modern science as a result of developments in chemistry and chemical engineering. The present volume is a collective work of a number of authors in which metals, their history, properties, extraction technology, and most important inorganic compounds and toxicology are systematically described.

Metals are neither arranged by alphabetical order as in an encyclopedia, nor according to the Periodic Table as in chemistry textbooks. The system used here is according to an economic classification which reflects mainly the uses, the occurrence, and the economic value of metals. First, the ferrous metals, i.e., the production of iron, steel, and ferrous alloys are outlined. Then, nonferrous metals are subdivided into primary, secondary, light, precious, refractory, scattered, radioactive, rare earths, ferrous alloy metals, the alkali, and the alkaline earth metals.

Although the general tendency today in teaching extractive metallurgy is based on the fundamental aspects rather than on a systematic description of metal extraction processes, it has been found by experience that the two approaches are complementary. The student must have a basic knowledge of metal extraction processes: hydro-, pyro-, and electrometallurgy, and at the same time he must have at his disposal a description of how a particular metal is extracted industrially from different raw materials and know what are its important compounds. It is for this reason, that this *Handbook* has been conceived.

The *Handbook* is the first of its type for extractive metallurgy. Chemical engineers have already had their Perry's *Chemical Engineers' Handbook* for over fifty years, and physical metallurgists have an impressive 18-volume *ASM Metals Handbook*. It is hoped that the

present four volumes will fill the gap for modern extractive metallurgy.

The *Handbook* is an updated collection of more than a hundred entries in *Ullmann's Encyclopedia of Industrial Chemistry* written by over 200 specialists. Some articles were written specifically for the *Handbook*. Some problems are certainly faced when preparing such a vast amount of material. The following may be mentioned:

- Although arsenic, antimony, bismuth, boron, germanium, silicon, selenium, and tellurium are metalloids because they have covalent and not metallic bonds, they are included here because most of them are produced in metallurgical plants, either in the elemental form or as ferroalloys.
- Each chapter contains the articles on the metal in question and its most important inorganic compounds. However, there are certain compounds that are conveniently described together and not under the metals in question for a variety of reasons. These are: the hydrides, carbides, nitrides, cyano compounds, peroxy compounds, nitrates, nitrites, silicates, fluorine compounds, bromides, iodides, sulfites, thiosulfates, dithionites, and phosphates. These are collected together in a special supplement entitled *Special Topics*, under preparation.
- Because of limitation of space, it was not possible to include the alloys of metals in the present work. Another supplement entitled *Alloys* is under preparation.
- Since the largest amount of coke is consumed in iron production as compared to other metals, the articles "Coal" and "Coal Pyrolysis" are included in the chapter dealing with iron.

I am grateful to the editors at VCH Verlagsgesellschaft for their excellent cooperation, in particular Mrs. Karin Sora who followed the project since its conception in 1994, and to

Jean-François Morin at Laval University for his expertise in word processing.

The present work should be useful as a reference work for the practising engineers and the students of metallurgy, chemistry, chemical engineering, geology, mining, and mineral beneficiation. Extractive metallurgy and the chemical industry are closely related; this *Handbook* will

therefore be useful to industrial chemists as well. It can also be useful to engineers and scientists from other disciplines, but it is an essential aid for the extractive metallurgist.

Fathi Habashi

## Table of Contents

	<i>Volume I</i>		<i>Part Seven</i>	<b>Refractory Metals</b>
<i>Part One</i>	<b>The Metal Industry</b>			26 Tungsten . . . . . 1329
	1 The Economic Classification of Metals . . . . . 1			27 Molybdenum . . . . . 1361
	2 Metal Production . . . . . 15			28 Niobium . . . . . 1403
	3 Recycling of Metals . . . . . 21			29 Tantalum . . . . . 1417
	4 By-Product Metals . . . . . 23			30 Zirconium . . . . . 1431
				31 Hafnium . . . . . 1459
				32 Vanadium . . . . . 1471
				33 Rhenium . . . . . 1491
<i>Part Two</i>	<b>Ferrous Metals</b>		<i>Part Eight</i>	<b>Scattered Metals</b>
	5 Iron . . . . . 29			34 Germanium . . . . . 1505
	6 Steel . . . . . 269			35 Gallium . . . . . 1523
	7 Ferroalloys . . . . . 403			36 Indium . . . . . 1531
				37 Thallium . . . . . 1543
				38 Selenium . . . . . 1557
				39 Tellurium . . . . . 1571
	<i>Volume II</i>		<i>Part Nine</i>	<b>Radioactive Metals</b>
<i>Part Three</i>	<b>Primary Metals</b>			40 General . . . . . 1585
	8 Copper . . . . . 491			41 Uranium . . . . . 1599
	9 Lead . . . . . 581			42 Thorium . . . . . 1649
	10 Zinc . . . . . 641			43 Plutonium . . . . . 1685
	11 Tin . . . . . 683		<i>Part Ten</i>	<b>Rare Earth Metals</b>
	12 Nickel . . . . . 715			44 General . . . . . 1695
<i>Part Four</i>	<b>Secondary Metals</b>			45 Cerium . . . . . 1743
	13 Arsenic . . . . . 795			
	14 Antimony . . . . . 823			<i>Volume IV</i>
	15 Bismuth . . . . . 845			
	16 Cadmium . . . . . 869			<i>Part Eleven</i>
	17 Mercury . . . . . 891			<b>Ferroalloy Metals</b>
	18 Cobalt . . . . . 923			46 Chromium . . . . . 1761
<i>Part Five</i>	<b>Light Metals</b>			47 Manganese . . . . . 1813
	19 Beryllium . . . . . 955			48 Silicon . . . . . 1861
	20 Magnesium . . . . . 981			49 Boron . . . . . 1985
	21 Aluminum . . . . . 1039			
	22 Titanium . . . . . 1129			<i>Part Twelve</i>
				<b>Alkali Metals</b>
	<i>Volume III</i>			50 Lithium . . . . . 2029
<i>Part Six</i>	<b>Precious Metals</b>			51 Sodium . . . . . 2053
	23 Gold . . . . . 1183			52 Potassium . . . . . 2141
	24 Silver . . . . . 1215			53 Rubidium . . . . . 2211
	25 Platinum Group Metals . . . . . 1269			54 Cesium . . . . . 2215

55 Alkali Sulfur  
Compounds.....2221

*Part* **Alkaline Earth Metals**  
*Thirteen* 56 Calcium .....2249  
57 Strontium.....2329  
58 Barium.....2337

**Authors**.....2355

**Name Index**.....2375

**Subject Index**.....2379

## Part Six

### Precious Metals

																	H	He				
Li	Be																B	C	N	O	F	Ne
Na	Mg	Al															Si	P	S	Cl	Ar	
K	Ca	Sc	Ti	V	Cr	Mn	Fe	Co	Ni	Cu	Zn	Ga	Ge	As	Se	Br	Kr					
Rb	Sr	Y	Zr	Nb	Mo	Tc	Ru	Rh	Pd	Ag	Cd	In	Sn	Sb	Te	I	Xe					
Cs	Ba	La <sup>†</sup>	Hf	Ta	W	Re	Os	Ir	Pt	Au	Hg	Tl	Pb	Bi	Po	At	Rn					
Fr	Ra	Ac <sup>‡</sup>																				

†	Ce	Pr	Nd	Pm	Sm	Eu	Gd	Tb	Dy	Ho	Er	Tm	Yb	Lu
---	----	----	----	----	----	----	----	----	----	----	----	----	----	----

‡	Th	Pa	U	Np	Pu	Am	Cm	Bk	Cf	Es	Fm	Md	No	Lr
---	----	----	---	----	----	----	----	----	----	----	----	----	----	----

## 23 Gold

HERMANN RENNER (WHOLE CHAPTER EXCEPT § 23.4.3); MARK W. JOHNS (§ 23.4.3)

23.1 History	1183	23.7.3 Sodium Disulfiteaurate(I)	1201
23.2 Properties	1186	23.7.4 Miscellaneous Gold Compounds	1202
23.2.1 Physical	1186	23.8 Alloys	1202
23.2.2 Chemical	1186	23.9 Quality Specifications and Analysis	1202
23.3 Occurrence	1188	23.9.1 Quality Specifications	1202
23.3.1 Abundance	1188	23.9.2 Sampling	1203
23.3.2 Gold Deposits	1188	23.9.3 Quantitative Analysis	1203
23.3.3 Gold Reserves and Resources	1189	23.9.4 Purity Analysis	1203
23.4 Production	1189	23.9.5 Trace Analysis	1204
23.4.1 Ore Treatment	1189	23.10 Uses of Gold and Gold Alloys	1204
23.4.2 Cyanidation	1190	23.10.1 Coins, Medals, Bars	1204
23.4.3 Recovery of Gold with Carbon	1190	23.10.2 Jewelry	1204
23.4.3.1 Adsorption of Gold by Carbon	1191	23.10.3 Electronics and Electrical Engineering	1207
23.4.3.2 Carbon-in-Pulp Process	1192	23.10.4 Solders	1207
23.4.3.3 Carbon-in-Leach Process	1194	23.10.5 Pen Nibs	1207
23.5 Gold Refining	1194	23.10.6 Chemical Technology	1208
23.5.1 Chemical	1194	23.10.7 Dental Materials	1208
23.5.2 Electrolytic	1196	23.10.8 Coatings	1208
23.6 Recovery of Gold from Secondary Materials	1197	23.10.9 Gold Leaf	1209
23.6.1 Recovery from Gold Alloys	1197	23.10.10 Catalysts	1209
23.6.2 Recovery from Sweeps	1197	23.11 Economic Aspects	1209
23.6.3 Recovery from Surface-Coated Materials	1198	23.12 Toxicology and Occupational Health	1211
23.7 Compounds	1199	23.13 References	1211
23.7.1 Potassium Dicyanoaurate(I)	1199		
23.7.2 Tetrachloroauric(III) Acid	1201		

### 23.1 History

Gold is the first element that humans recognized as a metal. Towards the end of the Middle Stone Age and the onset of the Neolithic Age (ca. 8000 B.C.), the world's climate changed greatly. Large areas became arid, necessitating the establishment of permanent settlements in river valleys such as the Euphrates, the Tigris, and the Nile. The earliest archaeological finds that can be reliably dated were made in predynastic Egypt (ca. 4000 B.C.) and Mesopotamia, which the Sumerians settled in 3000 B.C. Outstanding finds (ca. 3000 B.C.) were made close to modern Varna, on the Bulgarian shores of the Black Sea. Gold was first mentioned in literature in the Indian

Vedanta (before 1000 B.C.), the writings of Herodotus (484–425 B.C.), and the Old Testament (1000 B.C.).

Egypt was the principal gold country in the pre-Christian era and maintained that status until ca. 1500 B.C. Gold production reached its peak about 1300 B.C. when the first legal foundations for the production of gold were laid, awarding the Pharaoh the absolute monopoly. In ca. 2700 B.C. gold rings were introduced as means of payment; the first gold coins appeared around 600 B.C.

The origin of the gold used by the Egyptians is unclear. Substantial portions appear to have come from Nubia in Upper Egypt (nub = gold), but considerable quantities were proba-

bly imported following the frequently mentioned expeditions to "Punt".

The special status enjoyed by gold in Egypt also exerted an influence in neighbouring countries. The country of Ophir mentioned by Solomon as the origin of his gold may be identical with Punt, but India may also have been the supplier. The Egyptian gold trade expanded particularly under the impetus of the seafaring Phoenicians and Greeks.

Although Egypt was the principal gold country until about 1 B.C., gold was also found and utilized in other regions including India, Ireland, Bohemia, the Carpathian Mountains, Gaul, on the Iberian peninsula, and in the Caucasus.

Even in ancient times the ownership of gold shifted from one ruler to the other through conquests and the collection of tributes. Alexander the Great obtained possession of Indian gold as well as considerable portions of the Pharaohs' treasure. The Romans had little of the metal in their own regions but their military expeditions netted them major amounts in the form of booty; they also exploited the mineral wealth of the countries they had conquered, especially Spain, where up to 40 000 slaves were employed in mining. The state's accumulation of gold bars and coins was immense. Later, however, more and more gold was used in luxury goods and towards the end of the Roman empire a gold shortage was experienced.

The advent of Christianity in Europe in the Middle Ages reduced the general striving for gold. Moreover, until the beginning of the Middle Ages no dominant political power existed for organizing large-scale gold production. In Europe, only the deposits in the Sudeten mountains, the Carpathians, and the Alps were of any significance. Outside Europe, gold was produced in India, Japan, and Siberia.

Following the discovery of America at the end of the fifteenth century, the Spaniards transferred considerable amounts of gold from the New World to Europe. Although the conquistadors found a highly developed mining industry in Central America, their efforts to in-

crease gold production were largely unsuccessful; most of the finds consisted of silver. It was not until the discovery of deposits in Brazil that there was a noticeable increase in world gold production. These deposits were exploited from 1725 to about 1800.

Since about 1750 gold has been mined on a major scale on the eastern slopes of the Ural mountains. In 1840, alluvial gold was discovered in Siberia. The Russian deposits were exploited by the Czars and the land owners, who had to pay their taxes in gold. Russia produced about one fifth of the world's gold production, a proportion maintained until the present day.

The discovery of gold in California in 1848 increased gold production greatly. The special laws issued in the Western parts of the United States allowed private mining thanks to the right to stake claims. This type of working continued when gold deposits were found in Eastern Australia (1851), Nevada (1859), Colorado (1875), Alaska (1886), New Zealand and Western Australia (1892), and Western Canada (1896). However, these deposits soon lost much of their importance.

The strongest impetus was given to gold production through the discovery of the gold-fields of the Witwatersrand in South Africa in 1885. This extremely rich deposit appeared to guarantee steady exploitation far into the future. South African gold soon occupied a commanding position in the world market. Production grew continuously except for a short interruption by the Boer War (1899–1902). In the 1970s, gold production largely stabilized in South Africa and in the rest of the world. In South Africa, more than 300 000 people are now employed in the production of gold.

The discovery of large deposits of gold in Brazil in the 1970s stimulated prospecting activities. New production centers have been established in the Sierra Pelada of Brazil, Canada, Australia, Venezuela, and New Guinea (Ok Tedi), causing a pronounced shift in the geographic distribution of world gold production.

Gold mining in Ghana (Gold Coast) only began to play a role, if a modest one, in the

twentieth century, although the deposits were already known in the Middle Ages. Gold production in Zimbabwe and the neighboring eastern part of the South African bush veld form a moderate but not insignificant part in the overall production of southern Africa.

Total gold production in antiquity can only be assessed approximately. Up to the fall of the Roman Empire, production may have amounted to 10 000 t.

A total production figure of 2000–3000 t has been quoted for the Middle Ages. By the time of the discovery of America, annual world production had reached about 5 t.

An annual production of ca. 10 t was reached in ca. 1700, rising to ca. 15 t in 1800 and to 40 t by 1848, the year the Californian deposits were discovered. As early as 1852, more than 200 t/a were mined, but production subsequently decreased until 1890. Thereafter, the increased output of the South African mines raised annual world production to 500 t in 1904, 700 t in 1907, and 1000 t in 1936. At present that figure has reached 1700 t, of which Eastern-bloc countries contribute ca. 300 t.

The total world production of gold to date exceeds  $10^5$  t. More than a third of the present-day gold inventory is held by the central banks of the Western industrialized nations as currency backing. An even larger proportion is in private hands, much of it in the form of jewelry. Krugerrands alone account for 2000 t, and smaller quantities are circulating in industry.

The shares of individual states in the overall production until now are divided among South Africa (40%), the United States (15%), the ancient empires (ca. 10%), the former Soviet Union (ca. 10%), Australia (ca. 10%), and Canada (ca. 5%).

In antiquity, gold grains obtained by washing river sands were cold-worked into the desired objects. From ca. 3900 B.C., alluvial gold could be fused into larger lumps. The ancient Egyptians were the first to quarry gold-bearing rocks. Comminution of the rocks and washing were often preceded by heat treatment.

Analyses of archeological finds show that, in Egypt, the separation of gold from silver and copper was feasible, possibly as early as 2000 B.C. Silver was removed by annealing with common salt to give silver chloride [8]. The naturally occurring gold-silver alloy, electrum magicum, was separated into its constituents. The slagging of copper by adding lead followed by cupellation was also known.

In Spain, the Romans developed the technique of flush mining, by which vast masses of rock were dropped from a height, comminuted, and moved by currents of water. Amalgamation presumably originated at that time, although it was first mentioned in the literature in the 11th century A.D.

In the Middle Ages, fusion with lead and cupellation were developed further. Water-powered crushing machines were also introduced for pulverizing ore, and miners learned to process arsenic-containing gold ores by roasting.

The alchemists endeavored to manufacture gold by transmutation of base metals. It was not until the end of the 18th century that the entire concept was finally rejected as false. However, these endeavors led to a better understanding of chemical processes and to the birth of the true natural sciences.

The 17th century saw the discovery of separation by inquantation, i.e., the separation of gold and silver by nitric acid, and of affination, i.e., separation by sulfuric acid. With advancing industrialization in the 19th century new methods replaced the old, but some of the latter have retained some importance to this day. Production of gold as a by-product of other metallurgical processes, (e.g., the refining of copper, zinc, and lead), played an increasingly important role in Germany (Rammelsberg/Harz). In 1863, Plattner's method of chlorination was introduced in the United States and shortly afterwards in Australia. In 1867, MILLER succeeded in refining gold with chlorine. Refining by electrolysis according to WOHLWILL was introduced in 1878 and is still used for all fine gold of 9995 and 9999 purity. Since 1888, cyanide leaching has permitted economical beneficiation of the

Witwatersrand ores, which were less amenable to other methods due to the extremely fine distribution of the gold. Since 1970, conventional cyanide leaching has been superseded by the carbon-in-pulp process, which dispenses with filtration of the leached rock powder. More recently, the ecological problems caused by cyanide leaching have been overcome by treating the cyanide in the wastewater with hydrogen peroxide.

The recent expansion of gold production is also due to the mechanization of ore transportation and beneficiation. In South America, however, manual mining of ores is once again being resorted to. This politically motivated measure, taken with a view to creating jobs, made employment possible for 500 000 people.

Solvent extraction is being investigated as a new method for the rapid and effective refining of fine gold.

## 23.2 Properties [1, 20, 24–31]

The distinction between noble and base metals is in many ways arbitrary, and is generally determined by practical considerations and tradition. Gold is the classic noble metal and complies with all the criteria for this group of elements: resistance to air, humidity, and to normal wear. Gold is also remarkable among the metals in that it occurs in nature almost exclusively in its elementary state.

### 23.2.1 Physical

Gold, atomic number 79, atomic mass 196.96654, has only one naturally occurring isotope,  $^{197}\text{Au}$ . Its most important radioisotope, which is used in medicine, is  $^{195}\text{Au}$ ; it emits  $\epsilon$  and  $\gamma$  rays and has a half-life of 183 d. The electronic configuration of gold is  $[\text{Xe}] 4f^{14}5d^{10}6s^1$ . Its atomic radius is 0.1439 nm. The ionic radius for coordination number 6 is 0.1379 nm for  $\text{Au}^+$ , and 0.085 nm for  $\text{Au}^{3+}$ .

Some physical properties of gold are as follows:

<i>mp</i>	1064.43 °C
<i>bp</i>	2808 °C
Density at 20 °C	19.32 g/cm <sup>3</sup>

at 900 °C	18.32
at 1000 °C	18.32
at 1065 °C	17.32
at 1200 °C	17.12
at 1300 °C	17.00
Vapor pressure at 1064 °C	0.002 Pa
at 1319 °C	0.1
at 1616 °C	10
at 1810 °C	100
at 2360 °C	10 000
Atomic volume at 20 °C	10.21 cm <sup>3</sup> /mol
Electrical resistivity at 0 °C	$2.06 \times 10^{-6} \Omega\text{cm}$
Thermal conductivity at 0 °C	$3.14 \text{ W cm}^{-1}\text{K}^{-1}$
Specific heat	$0.138 \text{ J g}^{-1}\text{K}^{-1}$
Enthalpy of fusion	12.77 kJ/mol
Enthalpy of vaporization	324.4 kJ/mol
Tensile strength	127.5 N/mm <sup>2</sup>

The melting point of gold has been a fixed point on the temperature scale since 1968.

The unit cell of gold is face-centered cubic (type A1), with a lattice constant ( $a_0$ ) of 0.40781 nm. Gold as it occurs in nature usually does not have a very crystalline appearance. It exhibits threadlike, leaf-shaped, and spherical forms, on which cubic, octahedral, and dodecahedral surfaces can sometimes be seen. When large amounts of molten gold solidify, a characteristic pattern of concentric rings appears on the surface.

Pure gold that has not been mechanically pretreated is very soft. Its hardness on the Mohs' scale is 2.5, and its Brinell hardness is 18 HB. Gold is the most ductile of all metals. It can be cold drawn to give wires of less than 10  $\mu\text{m}$  diameter, and beaten into gold foil with a thickness of 0.2  $\mu\text{m}$ . Because of its softness, gold can be highly polished; this, together with its noble characteristics and brilliant color, gives it its yellow luster. The color of utility gold is less rich and varies considerably according to its alloy composition. Very thin gold foil is translucent; transmitted light appears blue-green.

The physical properties of gold and its alloys have been thoroughly investigated because of their significance for modern technology. For detailed information see [24].

### 23.2.2 Chemical [32]

Gold does not react with water, dry or humid air, oxygen (even at high temperature), ozone, nitrogen, hydrogen, fluorine, iodine,

sulfur, and hydrogen sulfide under normal conditions.

Sulfuric acid, hydrochloric acid, hydrofluoric acid, phosphoric acid, halide-free nitric acid (except in very high concentrations), and practically all organic acids have no effect on gold, either in concentrated or dilute solutions and at temperatures up to the boiling point. If a hydrohalic acid is combined with an oxidizing agent, such as nitric acid, a halogen, hydrogen peroxide, or chromic acid, gold will dissolve. Gold can also be dissolved in a combination of water and a halogen (the Plattner process) and in selenic acid. Figure 23.1 shows the dissolution rates of gold in the most important industrial agents used for its dissolution.

Aqueous solutions of alkali metal hydroxides, alkali metal salts of the mineral acids, and alkali metal sulfides do not attack gold. However, gold dissolves in solutions of alkali metal cyanides in the presence of oxygen (Figure 23.1) or other oxidizing agents, such as cyanogen bromide (the Diehl process), 4-nitrobenzoic acid (Figure 23.1) and 3-nitrobenzenesulfonic acid, provided they do not rapidly destroy the cyanide. Gold is also attacked by sodium thiosulfate solutions in the presence of oxygen, and by alkali metal polysulfide solutions.

Fused caustic alkalis do not attack gold, provided air and other oxidizing agents are excluded. Gold reacts vigorously with alkali metal peroxides to form aurates. It is inert to the alkali metal phosphates and borates, and to the alkali metal salts of the mineral acids, which can therefore be used as slagging agents for removing metallic impurities from gold.

Gold reacts readily with dry chlorine. The maximum reactivity occurs at 250 °C, and the minimum at 475 °C. Above 475 °C the reactivity increases with increasing temperature up to and beyond the melting point.

Gold can be recovered from solution by electrolytic deposition or by chemical reduction. If the tetrachloroaurate(III) complex is present, then iron(II) salts, tin(II) salts, sulfur dioxide, hydrazine, hydrazonium salts, oxalic acid, or ascorbic acid can be used as reducing agents.

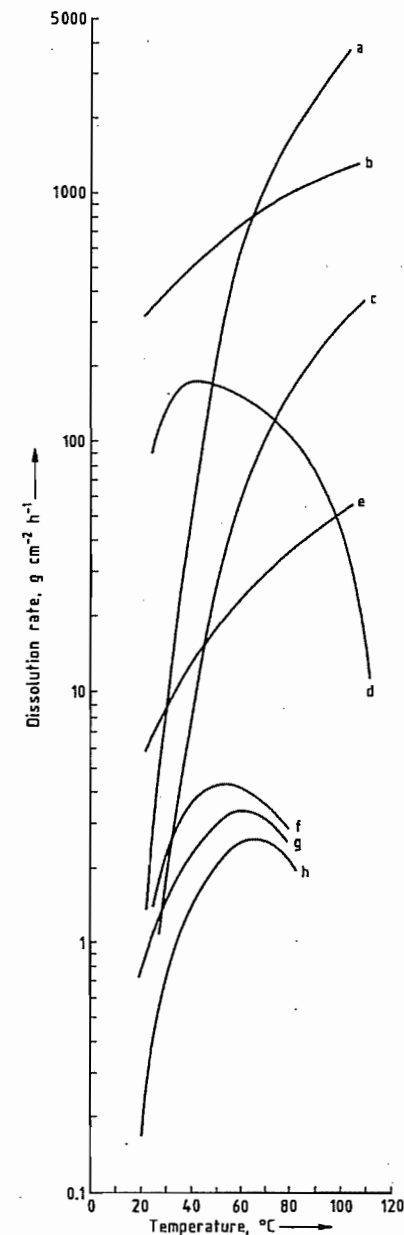

Figure 23.1: Rate of dissolution of fine gold sheet metal in various oxidizing agents: a) Aqua regia, 6 mol/L; b) HCl, 6 mol/L + Br<sub>2</sub>, 0.2 mol/L; c) NaCN, 0.45 mol/L + 4-nitrobenzoic acid, 0.1 mol/L + NaOH, 0.2 mol/L; d) HCl, 6 mol/L + Cl<sub>2</sub> (saturated); e) HCl, 6 mol/L + H<sub>2</sub>O<sub>2</sub>, 0.22 mol/L; f) NaCN, 1 mol/L + air; g) NaCN, 0.45 mol/L + NaOH, 0.2 mol/L + air; h) NaCN, 0.006 mol/L + Ca(OH)<sub>2</sub>, 0.04 mol/L + air.



The very stable dicyanoaurate complex requires stronger reducing agents such as zinc. Anion exchangers, which are used for the recovery of gold from solutions, sometimes reduce this complex to metallic gold. Similar results are achieved with activated carbon.

The standard potential of Au/Au<sup>3+</sup> is +1.498 V, of Au/Au<sup>+</sup> +1.68 V, and of Au<sup>+</sup>/Au<sup>3+</sup> +1.29 V.

Gold can be alloyed with many other metals. In classic metallurgical processes (e.g., the lead blast furnace process and the reverberatory furnace process for copper ore), gold and silver follow the same route. Zinc, lead, and copper act as collecting agents for gold through the formation of alloys. Gold exhibits the greatest affinity for zinc, followed by lead, and then copper. Zinc is used to remove gold from molten lead in the Parkes process. The readiness with which gold takes up lead, tellurium, selenium, antimony, and bismuth is a disadvantage, particularly with regard to subsequent mechanical processing. Gold alloys readily with mercury at room temperature to form an amalgam. The mercury can be distilled out by heating. This property is utilized in the amalgamation process, and in fire gilding.

Colloidal gold forms hydrosols of an intense red or violet color, which are relatively resistant even without protective colloids.

## 23.3 Occurrence [1, 2, 6, 20, 34–39]

### 23.3.1 Abundance

Gold is distributed very unevenly in the Earth's crust, mainly due to enriching processes that have taken place near the surface. Its average abundance is very low and is estimated at ca. 0.005 ppm, although widely varying figures are given.

The gold content of ocean water also varies greatly, depending on the location. Gold contents of 0.008–4 mg/m<sup>3</sup> (ppb) have been reported.

### 23.3.2 Gold Deposits [7, 11, 38]

The gold deposits which are most easily recognized, and which were the earliest to be discovered, are enriched veins and deposits of gold particles. These particles were originally present in primary rock that was worn down by weathering. Enrichment then followed with partial consolidation due to flowing water. Such deposits are known as *placer* or *secondary deposits*. Typical examples are the relatively small gold deposits in the Rhine Valley, California, and Alaska. The abundance of gold in placer deposits fluctuates greatly especially as the gold particles may be concentrated in very small areas, e.g., a stream bed. Under favorable conditions, placer deposits containing as little as 1 ppm gold may be successfully exploited.

Quartz veins containing gold are often found along the fault plane of rock fractures. As the gold particles have remained at their place of origin, these are termed *primary deposits*. In general, it can be assumed that this gold has been formed hydrothermally, i.e., it has been through an intermediate stage in aqueous solution. Such deposits are found in East Africa, Australia, Canada, and the former Soviet Union. Their gold content varies greatly.

The Witwatersrand goldfields in South Africa (Transvaal and Orange Free State) were also formed by sedimentation. These are sand and shingle deposits that have been compacted to form massive rock, in which the gold is distributed as very fine particles. This type of gold deposit is known as a *conglomerate deposit*. The average gold content of the ore when separated from the gangue is ca. 12 ppm. Mining reaches a depth of 4000 m. To date about 30 000 t of gold, i.e., about one-third of the total world gold production, have come from this ore. The waste extracted sand which is found, for example, around Johannesburg, contains about 1500 t gold (0.5 ppm), mainly contained in pyrites (FeS<sub>2</sub>) which is not dissolved by cyanide treatment. This material can also be processed economically.

Sulfidic copper ores may have gold inclusions which can become highly concentrated as a result of weathering. In the outer oxidation zone, hydrothermal reactions take place, such as

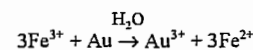

while in the underlying cementation zones, the corresponding back reaction occurs. Such deposits are found in Papua New Guinea (Ok Tedi) and in Brazil. The Ok Tedi deposit contains about 4 ppm of gold in the cementation zone.

Copper sulfide ores normally contain only a small proportion of gold (< 1 ppm); however, they can be a significant gold source. During smelting, gold accompanies silver and can be separated in the copper anode slimes. Practically all silver ores also contain some gold.

### 23.3.3 Gold Reserves and Resources

The term reserves denotes those resources whose existence has been established by prospecting and for which mining is economically viable. Today, world gold ore reserves are assessed at 70 000 t, or more than 40 times the world annual primary production. In 1970, gold reserves were calculated to be one-fifth of this amount. At that time, the extensive Brazilian deposits had not been discovered.

Of the reserves known today, 40% are found in South Africa, 35% in Brazil, and 15% in the Soviet Union. These are followed by the United States, Canada, Australia, Zimbabwe, and Ghana, with 1–3% each.

## 23.4 Production [1, 2, 20, 23, 31, 33, 39–49, 115]

### 23.4.1 Ore Treatment

In many places, gold is still mined by individuals and converted on the spot into marketable raw gold using simple manual and mechanical processes, such as panning (grav-

ity separation), milling, and amalgamation. Amalgamation is carried out by allowing a slurry of ground gold-containing ore to flow over mercury-coated copper plates. The resulting gold amalgam is periodically removed by scraping. Very fine gold particles cannot be recovered by these methods, and in many cases, especially in Brazil, the use of cyanidation to extract the residual gold has been proposed.

Where gold is found in river sands covering a large area, the ore is often mined and processed in floating dredgers. This type of mining is found, for example, in Siberia, and in the north of the American continent.

In the conglomerate gold deposits in Witwatersrand, South Africa, most of the gold occurs as very fine particles. This means that mechanical enrichment and amalgamation are impossible, and the gold must be converted to a soluble form by reaction with sodium cyanide. For this purpose, the gold particles are first released from the rock material by means of breakers, wet ball mills, and classifiers. In newer plants, this milling process takes place underground.

Ground gold ore that contains large gold particles or sulfides may be unsuitable for cyanidation. Pretreatment, consisting of gravity concentration, generally followed by amalgamation, is therefore nearly always necessary; this also allows up to 50% of the gold to be extracted faster than by the cyanidation process.

<sup>1</sup> *Gravity concentration* was formerly carried out using a cord cloth. The cloth was laid on a suitable support, and a water slurry of ground ore was passed over it, the grooves in the cloth being arranged at right angles to the direction of flow. The denser particles were retained in the grooves while the lighter quartz particles flowed away with the water.

The cord cloth has now been replaced by corrugated rubber (thickness 10 mm, groove depth 3 mm, distance between grooves 6 mm). Modern mechanical equipment has endless belts (width 1.5 m, length 7.2 m), tilted at an angle of 11°. These advance at a speed of 0.4 m/min against the direction of flow of the ore

slurry. The concentrate is sprayed off with water and sent to the amalgamation plant. In place of endless belts, slowly rotating cylinders lined with corrugated rubber are sometimes used (length 3.6 m, diameter 0.9 m, inclination 3.75°).

Concentrates from gravity separation processes cannot be directly melted down into gold bars, because they contain considerable amounts of iron pyrites and metallic iron. Gold and silver are therefore generally separated from these components by *amalgamation*. The concentrate, which has a water content of about 70%, is filled into a cast iron drum (length 0.9 m, diameter 0.6 m) containing steel balls (diameter 50 mm). The drum is rotated for 12 h, after which the gold particles are free from all impurities. Mercury is then added, and the drum is rotated for a further 2 h. The resulting amalgam is separated from the other components in a hydrocyclone (diameter 200 mm, inclination 20°); water and excess mercury are removed in a filter press. Remaining mercury is removed by distillation, leaving an impure mass of spongy gold, which is melted down into gold bars.

A *flotation process* is often used before gravity concentration in cases where the gold is closely associated with pyritiferous materials.

*Roasting* of ores in air is a secondary process which is sometimes used after gravity separation or flotation. The resulting oxides are then washed and treated by cyanidation. Gold ores containing sulfidic minerals can also be treated in a *bioleaching* process, which dissolves the sulfides, exposing the gold particles for subsequent cyanidation.

### 23.4.2 Cyanidation [42]

The cyanidation process has been used in South Africa since 1890. In this process, the powdered mineral slurry, which contains ca. 10 ppm gold in the solid matter, is treated with an aerated 0.03% sodium cyanide solution. Black cyanide (Ca(CN)<sub>2</sub> containing carbon and sodium chloride as impurities), a product of American Cyanamid, is often used instead

of the more expensive sodium cyanide. The addition of calcium oxide ensures that the solution remains slightly alkaline. Dissolution takes place according to the following reaction:

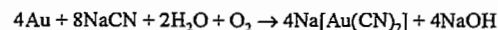

The dead powdered mineral is filtered off in large rotary vacuum filters. The filter cake contains less than a tenth of the original gold content of the ore. The filtrate is treated with zinc chips, which are preactivated in lead acetate solution, to precipitate the gold:

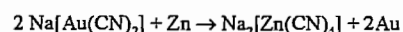

The raw gold is treated with sulfuric acid to remove excess zinc, dried, and then roasted in air at 800 °C to oxidize lead, zinc, and iron. A flux, usually borax, is added, and the material is melted down to raw gold, with a gold content of 80–90%.

An ecological problem is caused by the presence of sodium cyanide in the cake of dead rock material and in the wastewater. However, when exposed to air and sunlight, the cyanide is converted to nontoxic cyanate, and subsequently carbonate.

### 23.4.3 Recovery of Gold with Carbon [50–62]

The first mention of the ability of carbon to adsorb precious metals was made in 1847. In 1880, it was found that gold can be recovered from chlorinated leach liquors by wood charcoal. McARTHUR and the FOREST brothers discovered that cyanide was a good lixiviant for gold in 1890 and, in 1894, charcoal was used to recover gold from cyanide solutions. The charcoal was prepared from wood and did not possess the high surface area and porosity of carbon today. As no elution procedure was known, the gold was recovered from the carbon by smelting. The use of carbon reached a high point of efficiency in Australia in 1917 when fine carbon was used to recover gold from pregnant cyanide solution, but, as the zinc cementation process advanced, so interest in the use of carbon dropped off.

In the 1940s, a carbon of higher activity and greater abrasion resistance was developed from fruit pips and, in 1952, an elution procedure involving the use of sodium hydroxide and cyanide (the caustic–cyanide procedure) was developed. In 1960, a plant using carbon was erected in Canada, and the first major carbon-in-pulp (CIP) plant to treat the fraction from which the coarse material has been removed (slimes) was built in the United States at Homestake in 1973 to treat 2200 t/d.

Major developments in CIP continued in South Africa, for treatment of the total cyanided pulp. By 1976, a small pilot plant was in operation and, by 1978, a plant processing 250 t/d was on line. The CIP process is now the preferred method worldwide for the recovery of gold from cyanided pulp. The only exception appears to be the former Soviet Union, where the resin-in-pulp process is used. The CIP process is used for the treatment of a variety of feed materials ranging from run-of-mine ore to dump materials and roaster-bed products.

The advantages of the CIP process over zinc cementation are:

- Capital costs are lower.
- Operating costs are lower.
- The ability of carbon to adsorb gold is not affected by any of the common constituents of leach liquors.
- Carbon is added directly to the cyanided pulp, and therefore the need for the expensive filtration and clarification stage is avoided.
- The losses of soluble gold are usually lower than in the zinc cementation process.
- Ores that contain carbonaceous material can be processed without loss of gold to the carbonaceous fraction.
- Materials that are difficult to filter or thicken can be treated successfully.

### 23.4.3.1 Adsorption of Gold by Carbon

Activated carbon has a porous structure. The following theories have been proposed for the mechanism by which activated carbon loads gold cyanide:

- Complete reduction to metal
- A chemical precipitation mechanism involving gold, carbon monoxide, and cyanide
- Physical adsorption of sodium dicyanoaurate(I)
- Adsorption of the dicyanoaurate(I) ion
- Ion-exchange adsorption of the dicyanoaurate(I) ion
- Adsorption of a neutral complex whose nature is pH dependent
- Electrostatic interaction between the dicyanoaurate(I) ion and positively charged sites
- A physisorption process
- A two-step process in which an ion pair is adsorbed onto carbon and then reduced to an unidentified species.

The last-mentioned theory is now generally accepted.

The adsorption of gold cyanide onto activated carbon is reversible. Thus, an equilibrium exists between the gold in solution and the gold loaded on the carbon. Factors which affect the rate of gold adsorption and those which affect the equilibrium loading of gold are listed in Table 23.1.

Table 23.1: Factors influencing the adsorption of gold by carbon.

Factor	Effect of increasing the factor	
	on rate	on equilibrium loading of gold
pH	slight decrease	decrease
Ionic strength	slight decrease	increase
Free cyanide	slight decrease	decrease
Temperature	slight increase	decrease
Base metals	decrease	decrease
Carbon particle size	decrease	none
Mixing intensity	increase	none
Pulp density	decrease	none

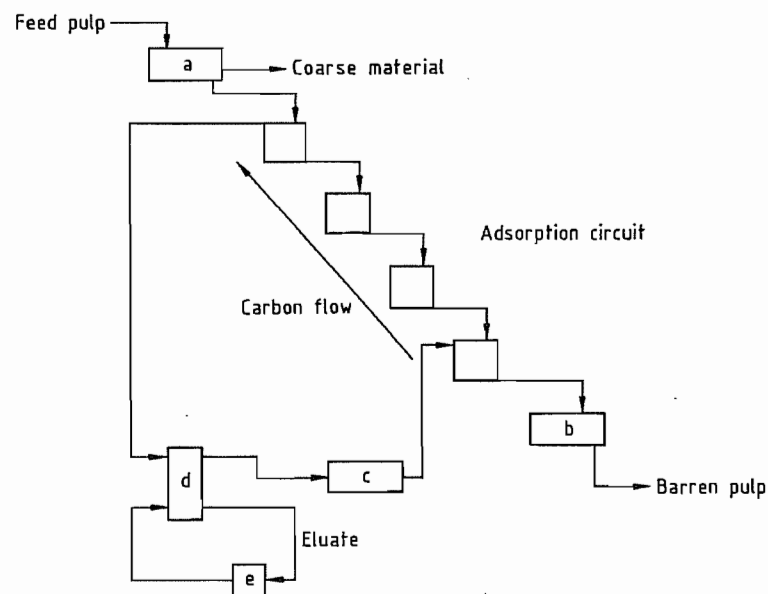

Figure 23.2: Schematic of the carbon-in-pulp circuit: a) Prescreening; b) Final screening; c) Regeneration; d) Elution; e) Electrowinning.

Certain materials poison activated carbon for gold adsorption. Calcium carbonate can form in the pores and is detrimental to adsorption, but is removed by acid-washing. Organic materials (e.g., machine lubricants, detergents, flotation reagents) also poison carbon to some extent, but are removed during reactivation. Lower adsorption efficiencies are attained when a pulp containing calcine, shale, or clay is used, since these finely divided minerals can block the pores. Copper can decrease efficiency of adsorption by competing with gold for adsorption sites, particularly at low concentrations of cyanide.

### 23.4.3.2 Carbon-in-Pulp Process

Ores containing 0.25–100 g/t gold are processed in CIP plants at tonnages from 100–10<sup>6</sup> t per month. The density of the pulp varies from 1.3 to 1.45 g/cm<sup>3</sup>, depending on its viscosity.

A schematic of a CIP plant is shown in Figure 23.2. The cyanided pulp is prescreened to remove coarse material that would otherwise move with the carbon granules, and might

later block the screens in the CIP circuit. The pulp then flows through a series of six or eight flat-bottomed, cylindrical, agitated tanks. The residence time of the pulp in each stage is ca. 1 h. Reactivated carbon is added to the last stage, and is moved countercurrent to the flow of pulp. The carbon is held in each stage by interstage screens. The residence time of the carbon in each stage is 2 d. The carbon concentration in a CIP circuit is 15–30 g per liter of pulp. The barren pulp leaving the circuit is screened to remove fine carbon.

The loaded carbon, which contains 200–20 000 g of gold per ton, is removed periodically from the first stage and eluted with a caustic-cyanide solution. The carbon is washed with acid to remove calcium carbonate, and then reactivated at high temperature in a kiln. The gold in the eluate is generally recovered by electrowinning.

**Screening.** The total pulp fraction has to be *prescreened* at a smaller aperture (0.6 mm, 28 mesh) than that of the interstage screens. Prescreening removes coarse material to avoid blocking of the screens further downstream. Two types of screen are used: (1) vibrating

screens with woven wire or polyurethane mesh, and (2) linear moving-belt screens.

Wood chips constitute a small fraction of the incoming pulp, and cause problems further downstream when vibrating screens are used. Another prescreening device, such as a dummy tank, is then required. A dummy-tank is a closed circuit tank in which the pulp passes through submerged air-cleaned screens to remove wood chips.

*Interstage screens* are used to retain carbon while allowing the finer pulp to flow down through the train.

The two types of screen that are used are external and submerged. With *external screens*, the pulp is air lifted onto the screens (normally vibrating decks), and transferred to the next stage, while the carbon is returned to the stage from which it came. A number of *submerged screens* have been developed. Air-cleaned screens normally use square metal mesh, while mechanically cleaned screens use wedge-wire. Duties on these screens vary from 50 to 200 m<sup>3</sup> of pulp per square metre of screen per hour. The aperture of the screens is 0.8 mm (20 mesh). The size of the carbon particles used in CIP is 1–2 mm (8 to 16 mesh), although larger particles are used when problems are encountered with screening.

Abraded carbon resulting from breakage of the carbon in the CIP circuit is recovered from the barren pulp by a final screen. The units and apertures of this screen are similar to those used for prescreening.

**Interstage movement of carbon** is achieved using airlift pumps, vertical spindle pumps, centrifugal pumps, or peristaltic pumps. Factors that affect the choice of pump are controllability, carbon wear, and operating costs. In most plants, carbon is transferred intermittently, but may also be transferred continuously. The following methods are used:

- Loaded carbon is removed from stage one, the carbon in stage two is then transferred to stage one, and so on down the train.
- Regenerated carbon is added to the last stage, the carbon in the last stage is then

transferred to the second-last stage, and so on up the train.

- All the pumps are turned on to transfer the carbon in each stage to the next stage up the train.

**Agitation.** The optimum agitation system provides a high pulp flow and low shear to avoid carbon breakage. Mechanical agitation is favored over air agitation because it consumes less power, provides better 'live' vessel volume, and has acceptable carbon-attrition rates. Draft tubes and open-impeller agitators are used. Power inputs vary from 0.015 to 0.2 kW/m<sup>3</sup> of pulp.

**Elution.** The gold capacity of carbon decreases with increasing temperature. Increasing the concentration of cyanide and hydroxide ions also decreases the capacity of the carbon for gold.

These two facts were exploited by ZADRA in 1952 to develop the first efficient elution technique to remove gold from carbon. Other elution procedures have since been developed.

The *Zadra process* involves the recycling of a solution containing 1–2% sodium cyanide and 1–2% sodium hydroxide through a bed of carbon. The temperature is over 85 °C, and the flowrate is about one bed volume per hour. The elution takes 48 h to complete. An electrowinning cell is used to recover the gold from the eluate. The advantages of this system are that the capital costs are low, the process is simple, and the reagent consumption is low. Its major disadvantage is that the rate of stripping is slow.

The *AARL process*, which was developed by the Anglo American Research Laboratories, has two stages. In the first stage, the carbon is pre-soaked under pressure at a temperature above 115 °C, in a solution containing 1–5% sodium cyanide and 1–5% sodium hydroxide for several hours. In the second stage, the carbon is eluted with five to seven bed volumes of water at 50–100 kPa and above 110 °C for 5 h at a flowrate of three bed volumes per hour. The advantages of this procedure are that elution is fast and the gold concentration in the eluate is high, which leads to

efficient electrolysis. Its disadvantages include the need for high-quality water, more expensive equipment than that used by the Zadra process, and higher reagent consumption.

**Elution with Organic Solvents.** The addition of, for example, a 20% solution of ethanol to a caustic-cyanide eluant increases the rate of elution, which takes ca. 6 h at atmospheric pressure and 80 °C. Disadvantages include higher reagent costs and handling problems associated with organic solvents.

The *high-pressure stripping process* is similar to the Zadra process, except that elution is carried out at up to 160 °C and at ca. 350 kPa. It has the advantages of lower reagent consumption, smaller elution inventory, and a smaller elution circuit. Disadvantages are more costly equipment, and that effluent solutions have to be cooled to avoid flashing.

**Gold Recovery.** The gold is recovered from the eluate either by zinc precipitation or by electrowinning. A number of electrowinning cells have been developed.

The *Zadra cylindrical cell* consists of a cylindrical core (polypropylene basket), which contains steel wool and acts as the cathode. The anode (stainless steel) surrounds the cathode in the cell, and the eluate is pumped into the center.

The most commonly used cell is the *Mintek cell*. It has a rectangular configuration with alternating anodes and cathodes in parallel, similar to those in copper-electrowinning cells. The cathodes are removable plastic baskets with perforated sides, packed with steel wool. The anodes are perforated stainless-steel plates. The flow of eluate is parallel to the flow of current.

**Regeneration of carbon** is carried out in two stages: (1) washing with acid to remove calcium carbonate and some base metals, and (2) thermal reactivation to remove organic materials and reexpose the pore structure.

The loaded carbon is washed with a 5% solution of hydrochloric acid for 6 h at 75 °C in a column constructed of Hastelloy or rubber-lined mild steel. The carbon is then neutralized

with sodium hydroxide. Acid-washing can be carried out before or after elution, but is generally done first because this increases the efficiency of elution.

In thermal reactivation, the degree of activation increases with increasing temperature and residence time, but micropores are destroyed if the conditions are too harsh. Reactivation is typically carried out at 700 °C for 10 min. Air should be excluded during regeneration. The steam generated from the carbon is normally sufficient to exclude air. The regenerated carbon is normally cooled by quenching in water.

Regeneration is usually carried out in a *rotary kiln*, which is heated externally by electrical resistive windings. In the *Rintoul furnace*, heating is achieved by passing an electric current through a bed of predried carbon in the presence of steam.

### 23.4.3.3 Carbon-in-Leach Process

Some ores contain carbonaceous material that is slightly active and can adsorb dissolved gold. These carbonaceous materials are termed *preg-robbers*. When a *preg-robbler* is present in an ore, the carbon-in-leach (CIL) process is used, in which cyanidation and carbon adsorption occur in the same reactor.

The CIL circuit is similar to a CIP circuit, the main difference being the residence time of the pulp, since in CIL this is determined by the rate of gold dissolution and not by the rate of gold adsorption as in CIP. Hence, residence times of 4 h per stage are used. The presence of activated carbon prevents the *preg-robbler* from adsorbing gold.

## 23.5 Gold Refining [1, 20, 23, 31, 33, 40, 41, 45, 47, 49]

### 23.5.1 Chemical [2, 63]

The historical methods for separating gold from silver depended on dissolving silver and any accompanying base metals from solid solutions containing gold, using either nitric acid (inpartation) or sulfuric acid (affination).

They were accepted up to the second half of the nineteenth century as the best way of manufacturing relatively pure gold. However, these methods are now considered inefficient, both with regard to the purity of the gold recovered and process management.

A method which allows recovery of relatively pure gold is to dissolve the raw gold in hydrochloric acid in the presence of an oxidizing agent. Silver chloride precipitates and can be removed, while gold is precipitated by reduction with oxalic acid. However, a single reductive precipitation process is usually insufficient, as part of any palladium present is entrained by the gold. If sulfur dioxide is used instead, the same applies to copper, nickel, zinc, and lead. Precipitation and separation normally have to be repeated several times before fine gold of sufficient purity is obtained. This method has therefore only found acceptance in cases where the commoner processes have not been established, either because the amounts involved are too small, or because the need arises only sporadically. However, acid dissolution has several advantages: the metal is tied up for a short time only; a high yield of gold can be obtained in a single process step; and conventional equipment can be used.

The Miller process [64] has been of commercial significance since the 1870s. Probably more than two thirds of all gold produced to date has been through this process. It is extremely economical, and the gold quality obtained (99.5–99.6%) meets the requirements of the gold trade. The largest plant in the world is the Rand Refinery in Germiston, South Africa, which refines all the gold from South African mines, as well as that from neighboring countries. The Miller process is used not only by the mining companies of almost all gold-producing countries, but also in recycling processes.

The Miller process is based on the fact that gold chlorides are unstable above 400 °C and thus do not form at a reaction temperature of ca. 1100 °C, whereas silver and base metals react with chlorine to form stable chlorides. At this temperature, AgCl (*bp* 1554 °C) and CuCl (*bp* 1490 °C) are molten and therefore collect

in a slag layer, which is considerably less dense than molten gold. The chlorides of the other metals volatilize at the reaction temperature, for example, PbCl<sub>2</sub> (*bp* 954 °C), FeCl<sub>2</sub> (*bp* 1023 °C), FeCl<sub>3</sub> (*bp* 319 °C), ZnCl<sub>2</sub> (*bp* 732 °C), and CuCl<sub>2</sub> (*bp* 655 °C). As the process is effective when only a slight excess of chlorine is used, the amount of CuCl and FeCl<sub>2</sub> formed is greater than that of CuCl<sub>2</sub> and FeCl<sub>3</sub>.

The raw gold delivered to the Rand refinery is weighed to an accuracy of 0.01 oz and then melted in an induction furnace. Four samples are taken and analyzed for gold content. The gold is cast into bars and reweighed. The gold content of the whole load is then determined. The bars are remelted in an induction furnace in batches of 500 kg, and chlorine gas is passed into the molten metal through quartz pipes at a pressure of 0.2 kPa. First, the chlorine reacts selectively with iron, zinc, and lead (Figure 23.3), whose chlorides are volatile at the reaction temperature and are thus removed as vapors. Finally, silver and copper chlorides form (Figure 23.3). These are molten at the reaction temperature and thus form a slag which floats on the molten gold. Borax is added to the slag as a flux. The end point of the reaction is indicated by the appearance of red gold chloride vapor, and is confirmed by taking a sample for analysis. The silver content, which is determined by X-ray fluorescence analysis, must be below 0.4%. After pouring off the slag, the gold is poured into tared molds.

The chloride slag is ground and screened. Entrained gold is separated and returned to the process. Copper(I) chloride is oxidized to copper(II) chloride using sodium chlorate solution containing hydrochloric acid, and brought into solution. The solution is filtered and copper is cemented. Silver chloride is reduced with zinc in aqueous solution, and sent to a silver-refining electrolysis process.

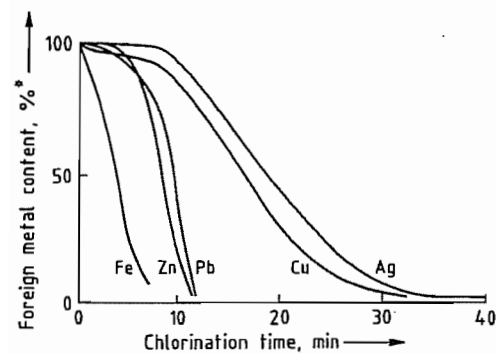

**Figure 23.3:** Decrease in the concentration of impurities in gold as a function of chlorination time. \* Expressed as a percentage of the initial metal content. Typical starting concentrations, %: Ag 9.0, Cu 1.4, Pb 0.35, Fe 0.18, Zn 0.06.

Platinum-group metals cannot be separated by the Miller process, as their chlorides, like those of gold, do not exist at the reaction temperature. However, this is not a disadvantage for gold from the Witwatersrand deposits, as this is free from platinum-group metals.

The great economic advantage of the Miller process, in addition to low production costs, lies in the fact that the gold leaves the refinery in a marketable form, thus minimizing the financial losses due to tying up of the metal.

Tetrachloroauric(III) acid can be extracted from aqueous solution by many organic solvents [66]. Solvents which can form metal complexes (e.g., ethers and esters) are most effective. Total separation from the usual accompanying elements cannot, however, be achieved.

With the exception of dibutyl carbitol, no systems have yet been discovered which can be applied commercially. Yet a system with a high degree of separation efficiency and simple process management, including stripping the pure gold, could offer considerable advantages over currently used methods.

### 23.5.2 Electrolytic [23, 65]

The Wohlwill electrolytic refining process for gold was developed in 1878 at the Norddeutsche Affinerie in Hamburg. It is still indispensable for the industrial production of fine

gold of quality  $\geq 99.9\%$  (in practice usually 99.95% and 99.99%).

The Wohlwill process uses an electrolyte containing 2.5 mol/L of hydrochloric acid and 2 mol/L of tetrachloroauric acid. Electrolysis is carried out with agitation at 65–75 °C. The raw gold is introduced as cast anode plates. The cathodes, on which the pure gold is deposited, were for many years made of fine gold of thickness 0.25 mm. These have now largely been replaced by sheet titanium cathodes, from which the thick layer of fine gold can be peeled off. In a typical electrolysis cell (Figure 23.4), gold anodes weighing 12 kg and having dimensions 280 × 230 × 12 mm are used. Opposite them are conductively connected cathode plates, arranged two or three on a support rail. One cell normally contains five or six cathode units and four or five anodes. The maximum cell voltage is 1.5 V and the maximum anodic current density 1500 A/m<sup>2</sup>. At the anode, the reaction

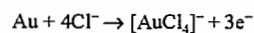

takes place, and at the cathode the reverse reaction. Anodes and cathodes are normally replaced every two days. About 10% of the anode gold, especially parts located above the electrolyte, is remelted to form new anodes. The anode slime is collected in a trough in the bath. In addition to silver chloride, it contains rhodium, iridium, ruthenium, and osmium, which can be recovered. Platinum and palladium can be recovered from the electrolyte, which also contains copper, iron, and nickel.

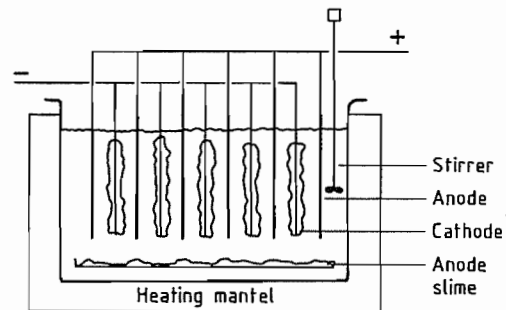

**Figure 23.4:** Wohlwill electrolytic cell.

The accumulation of metallic impurities in the electrolyte, and of anode slime in the cell,

means that the electrolyte can only be used for a limited period of time. Therefore, the material to be refined should have a high gold content (generally > 95%) and it is often best to use gold which has already been through the Miller process. The gold quality of the cathode deposits depends on the condition of the electrolyte, and on the amount of anode slime that has collected in the cell. A purity of 99.9% is considered to be a minimum, which is the quality of Russian commercial gold. Today, 99.99% can be considered as the norm, rather than 99.95%.

The great advantage of the Wohlwill electrolysis process is the high purity of the gold produced. In addition, the by-products, especially platinum-group metals, are also relatively easy to isolate. A disadvantage is the fairly long period during which the noble metal is tied up, leading to considerable financial losses.

World capacities for Wohlwill electrolysis are very large. In South Africa, approximately a quarter of all gold from primary production, after it has gone through the Miller process, undergoes final purification to fine gold by Wohlwill electrolysis. In the former Soviet Union, all gold is treated by electrolysis, as it normally contains platinum-group metals. Practically all noble-metal parting works which recover gold from secondary materials are dependent on electrolytic refining, again because platinum-group metals are normally present. Today, almost exclusively fine gold (99.99%) is used, both for industrial purposes, and for investment; trading countries such as Switzerland therefore have large refining capacities, mainly producing gold of a quality between "good delivery" (99.5%) and 99.9%.

## 23.6 Recovery of Gold from Secondary Materials [1, 3, 20, 23, 31, 40, 41, 67–72]

### 23.6.1 Recovery from Gold Alloys

For the recovery of gold from alloys with a gold content of more than 30%, the Miller

process is the most economical method. This also applies to the treatment of anode slimes from the electrolytic refining of silver, providing these have a high gold content and can be melted.

For small quantities of *gold-rich alloys*, a useful treatment is dissolution in hot aqua regia, or in hydrochloric acid (usually at 20–50 °C) containing a halogen or hydrogen peroxide. Silver precipitates as sparingly soluble silver chloride. Relatively pure gold is recovered from the solution by selective reduction. If copper and lead ions are present, the best reducing agents are sulfur dioxide or hydrazine; if platinum-group metals are present, oxalic acid is used.

In the case of *gold-copper alloys*, which also may contain silver and nickel, treatment with aerated dilute sulfuric acid allows the separation of noble metals from base metals. Gold can only be separated from base metals in this way if the gold content of the alloy is less than ca. 65%, and the material has been finely milled or powdered.

Two historically important processes for treating *gold-silver alloys* are rarely used today. The silver may be dissolved with nitric acid, preferably after re alloying to a silver-gold ratio of 3:1 (inquartation); or hot concentrated sulfuric acid can be used (affination). Silver-copper alloys with a low gold content are not suited to the above process, but can be treated in noble-metal works by the lead cupellation process. Lead is removed as litharge, PbO, which also takes up copper as CuO, and other metal and metalloid oxides, leaving behind dore silver. This is subjected to electrolytic refining; gold collects in the anode slime.

### 23.6.2 Recovery from Sweeps

The noble-metal processing industry produces large amounts of waste dust and debris, known as sweeps (e.g., slag, ash, soot, precipitation and emulsion residues, and sweepings). The gold content of these materials is mostly in the range 0.5–10%. Usually they are first carefully ground, screened, and, if necessary, dried or burned. The fine nonmetallic fraction

and the coarse metallic fraction, which can usually be melted, are analyzed separately.

The usual method for treating gold-containing sweeps is to melt the material down, together with silver-containing sweeps, in a lead shaft furnace. Depending on the composition of the sweeps, calcium carbonate, silicic acid, lead oxide, carbon, and materials containing sulfur are added. The mixture of powdered components is normally briquetted, pelletized, or sintered before being fed into the shaft furnace. The metallic phase (alloy) produced in the furnace contains lead and almost all of the noble metal. This alloy is then converted to dore silver (a few percent Au; < 0.1% Pb; the rest Ag) in a cupel furnace by oxidizing lead to lead(II) oxide. The silicate slag from the shaft furnace contains a negligible quantity of noble metal, and can usually be discarded. The slagging process may have to be repeated, for example if the noble-metal content exceeds 300 ppm. In the sulfidic phase, which forms between the metallic phase and the slag, almost all the copper collects with the nickel to form copper matte. The relatively high content of silver and valuable nonferrous heavy metals in the copper matte makes special treatment necessary; this is usually carried out at copper smelting works.

When raw gold is refined, the resulting residues contain more gold than silver. These substances are treated in a shaft furnace and then in a refining furnace, together with raw silver from the Miller process. Unlike other pyrometallurgical recycling methods for silver and gold, a copper matte phase is not formed in the shaft furnace. The Au:Ag ratio is normally 1:4.

### 23.6.3 Recovery from Surface-Coated Materials

Surface coatings containing gold come mainly from the electronics industry, plus a small proportion from the jewelry industry and electrical engineering. The base material is essentially metallic; the gold coatings are often only a few micrometers thick, but may

account for a gold content between a few tenths percent and a few percent.

The most economic solution is usually to remove only the gold coating, and to send the underlying base material directly to a recycling process. Mechanical pretreatment is often required to expose the gold surface. Depending on the particular combination of materials and the degree and type of finishing employed, this can be carried out with a shredder, jaw crusher, or edge runner. Frequently, this is followed by air separation, gravity separation, or magnetic separation to remove the ballast materials. It is normally not advisable to burn off plastic materials because the gold diffuses into the metallic base, and it is then impossible to remove it all. For this reason it is preferable to decompose the plastic material by pyrolysis.

To remove the gold from the metallic base, the material is usually agitated in alkaline cyanide solutions (10–20 g/L NaCN). Air is only rarely used as an oxidizing agent, because of the relatively low rate of dissolution. Instead, water-soluble aromatic nitro compounds (e.g., nitrobenzoic acid or nitrobenzenesulfonic acid) are normally employed. Potassium peroxodisulfate and hydrogen peroxide are also suitable, but they have a greater tendency to oxidize the cyanide ion. The base materials (e.g., iron, nickel, and cobalt) are attacked only to a limited extent during the dissolution process. When the base material is composed of copper, or a copper-rich alloy, zinc cyanide or lead salts are usually added as inhibitors to keep them from being attacked.

The gold is recovered from cyanide solution by adding zinc powder, after any excess oxidizing agent has been reduced with hydrazine or formaldehyde. The gold can also be recovered by electrolysis, using insoluble graphite or magnetite anodes (100 A/m<sup>2</sup> cathode, 3–4 V), or platinized titanium anodes. Excess oxidizing agent should also be reduced to obtain optimum current efficiency and speed of deposition. In addition to the reductive deposition of gold, thermal decomposition of the dicyanoaurate(I) complex is also possible.

Gold-plated metallic wastes can also be directly depleted by electrolysis, preferably in electroplating drums used as anodes. The gold is recovered in metallic form from the cathode in a single step. The method is, however, not very well suited to the recovery of gold from bulk material in anode baskets, because the electric field is screened off from the material at the center of the load, and as a result not all the gold is removed.

Gold can be extracted from solutions with a very low gold content ( $\leq 0.1$  g/L) by anion-exchange resins (e.g., Lewatit M 500) [71] or activated charcoal [72]. However, elution is costly and usually incomplete; the gold-loaded carriers are therefore most frequently ashed, and the gold recovered from the ash. The solutions are not returned to the deplating process because they contain degradation products, especially from organic nitro compounds, which would interfere with the process.

The methods described above can also be used to treat other cyanide gold solutions, e.g., unusable electroplating baths.

Gold-plated materials are occasionally smelted together with copper ores in large copper-smelting works. In addition to silver, these ores always contain some gold. A disadvantage of this method is the long time the gold has to stay in the process. Gold collects in the anode slimes during electrolytic refining of the copper and can be recovered from these. All gold concentrates recovered using the processes described here still require refining.

## 23.7 Compounds [1, 12, 20, 32, 39, 63, 73–77]

Almost all gold compounds occur in the oxidation states 1+ and 3+. The oxidation states 2+ and 5+ are also known. Bimetallic compounds of gold(II) are usually mixed valence compounds containing gold(I) and gold(III).

The generally very low stability of binary gold(I) and gold(III) compounds based on ionic bonding can be ascribed to the structure of the two outer electron shells. The ten electrons of the 5d level and the single electron of

the 6s level differ only slightly in energy. Therefore, ionization of the 6s<sup>1</sup> electron to leave a 5s<sup>2</sup>6p<sup>6</sup>d<sup>10</sup> valence shell, i.e., the reaction  $\text{Au} \rightarrow \text{Au}^+$ , is energetically not particularly favorable. Gold(III) compounds with the 5s<sup>2</sup>6p<sup>6</sup>d<sup>8</sup> valence shell exhibit a tendency to fill the 5d level. Thus, the electron-acceptor effect is strong, and the compounds are strong oxidizing agents. The simultaneous participation of both outer electron shells gives rise to properties characteristic of the transition metals, such as variable oxidation state, colored compounds, and the tendency to form complexes.

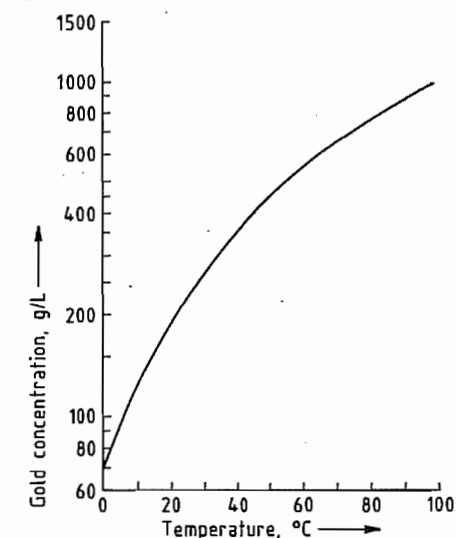

Figure 23.5: Solubility of potassium dicyanoaurate(I) in water as a function of temperature.

### 23.7.1 Potassium Dicyanoaurate(I)

**Properties.** Potassium dicyanoaurate(I),  $\text{K}[\text{Au}(\text{CN})_2]$ ,  $\rho$  3.452 g/cm<sup>3</sup>, forms colorless crystals which are readily soluble in water and alcohol, but insoluble in acetone and ether. The solubility in water is strongly dependent on the temperature (Figure 23.5). The effect of potassium cyanide concentration on the solubility of potassium dicyanoaurate is shown in Figure 23.6. The complex is neither air nor light sensitive and is stable in aqueous solution above pH 3.

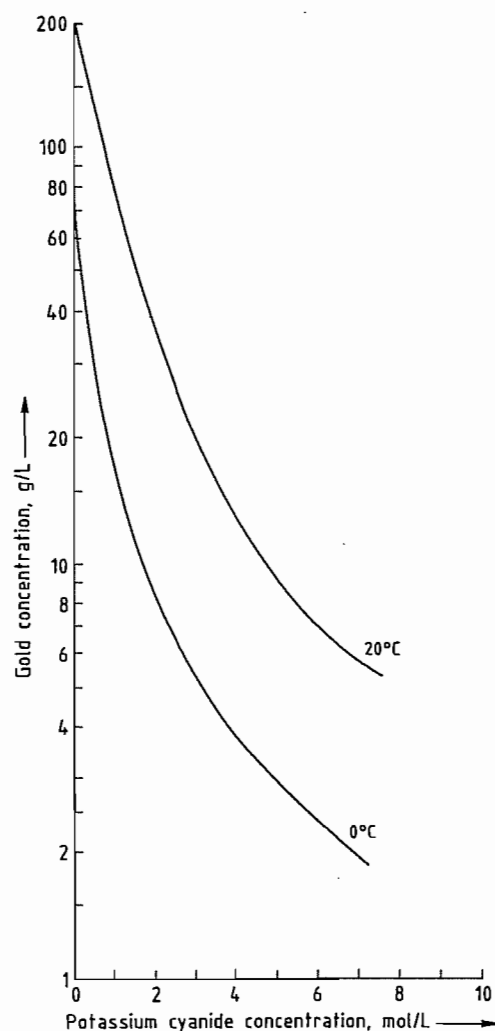

Figure 23.6: Dependence of the solubility of potassium dicyanoaurate(I) in water upon the concentration of potassium cyanide at 20 °C and at 0 °C.

**Preparation** [63, 78]. Potassium dicyanoaurate is prepared from fulminating gold, from gold(III) hydroxide, and by electrolysis.

*From Fulminating Gold.* Fulminating gold is precipitated from a solution of tetrachloroauric(III) acid by addition of excess aqueous ammonia; the precise composition of the precipitate is not known. The chloride content of the precipitate decreases with increasing excess of ammonia.

Fulminating gold must not be allowed to dry, since it is highly explosive in this state. The fulminating gold must be thoroughly washed with deionized water to remove chloride, since chloride ions interfere in electroplating processes. After washing, the precipitate is dissolved in a small excess of potassium cyanide solution. This is followed by filtration, concentration, and crystallization. The mother liquor is repeatedly reused in the process.

*Electrolysis.* When a gold anode is dissolved in aqueous potassium cyanide, potassium dicyanoaurate(I) is formed with hydrogen being liberated at the cathode. To prevent the dicyanoaurate(I) ion from being electrolyzed at the cathode with deposition of gold, a diaphragm is used. Fluoropolymer-based ion-exchange membranes are used for this purpose. The mother liquor is reused or worked up following crystallization of the potassium dicyanoaurate(I). This can be carried out under particularly mild conditions by using the continuously-cooled crystallization process. Cyanide and chloride are the major impurities. Electrolysis produces potassium dicyanoaurate(I) with a particularly low chloride content, which depends solely on the quality of the potassium cyanide and of the water.

*From Gold(III) Hydroxide.* Instead of fulminating gold, gold(III) hydroxide may be reacted with potassium cyanide solution. Precipitation of gold(III) hydroxide from tetrachloroauric(III) acid by addition of an alkali metal hydroxide does not always go to completion. Aging of the gold(III) hydroxide considerably reduces its rate of dissolution in potassium cyanide solution.

**Uses and Economic Aspects.** Potassium dicyanoaurate(I) serves as the gold component in the baths commonly used for electroplating and to a lesser extent in electroless plating.

With increasing utilization of gold-plated electronic components, the demand for gold plating baths, and hence for potassium dicyanoaurate(I), has grown considerably. In 1987, a little under one tenth of the 1300 t of gold

processed annually in the world was used by the electronics industry. In the jewelry industry, too, that demand has increased as a result of rolled gold being superseded by electroplating with hard gold.

### 23.7.2 Tetrachloroauric(III) Acid

**Properties.** Tetrachloroauric(III) acid,  $H[AuCl_4]$ , crystallizes as a tetrahydrate in the form of light yellow, deliquescent crystals. It is readily soluble in water, soluble in alcohol and ether, and is corrosive.

**Preparation** [63]. Tetrachloroauric acid is prepared by dissolving gold in warm aqua regia. In order to remove residual nitric acid, the solution is concentrated by evaporation with repeated addition of hydrochloric acid, and the resulting melt is poured into porcelain dishes. Moisture must be excluded while the melt cools, solidifies, and is finally powdered. Crystallization from the aqueous mother liquor produces an extremely hygroscopic material. Instead of nitric acid, other oxidants (e.g., chlorine) may be added to the hydrochloric acid. The high rate of dissolution of aqua regia is only rarely attained (Figure 23.1), but the pollution caused by it is lower and control of the reaction is simpler, especially under industrial conditions. Care must be taken to assure removal of any excess oxidants and their reaction products. Tetrachloroauric(III) acid can also be prepared by anodic dissolution of gold in hydrochloric acid, but this requires the use of a diaphragm.

**Uses** [1]. Tetrachloroauric(III) acid is used to prepare other gold compounds. It is also used to make gold ruby glass, gold purple (Purple of Cassius), and purple colorants for enameling of ceramics.

### 23.7.3 Sodium Disulfitoaurate(I)

**Properties.** Sodium disulfitoaurate(I),  $Na_3Au(SO_3)_2$ , is relatively unstable in the solid state, and is therefore not isolated as crystals for industrial use. It is stable in

weakly alkaline solutions above pH 8.5, even upon heating and when exposed to light.

**Preparation.** Sodium disulfitoaurate(I) is prepared from fulminating gold or from gold(III) hydroxide.

*From Fulminating Gold.* Fulminating gold is dissolved with stirring in a dilute solution of sodium hydrogen carbonate, sodium sulfite is then added. The reaction mixture is stirred at 70 °C until it clears. The pH must be maintained above 9. This is achieved by addition of sodium hydrogen carbonate solution. In order to remove ammonia, the solution is heated to about 90 °C with the simultaneous introduction of air. The gold content of the solution is kept at ca. 100 g/L by evaporation or by dilution with deionized water. This concentration is desirable for electroplating purposes. Instead of sodium sulfite, gaseous sulfur dioxide and a correspondingly higher quantity of sodium hydroxide solution may be used; the pH is controlled as described above.

*From Gold(III) Hydroxide.* Instead of fulminating gold, gold(III) hydroxide may be used. The reaction takes place under approximately the same conditions as with fulminating gold. The disadvantages are the same as in the preparation of potassium dicyanoaurate(I) from gold(III) hydroxide.

**Uses.** Sodium disulfitoaurate(I) is sometimes used in preference to potassium dicyanoaurate(I) in electroplating baths. These baths are especially advantageous for the production of ductile and wear-resistant coatings and in white-gold and rose-gold electroplating. Their drawbacks are difficult handling, shorter service life, and higher price. Their low toxicity is counterbalanced by problems in waste water disposal, e.g., those caused by the ethylenediaminetetraacetic acid (EDTA) complexes of the alloying elements.

Sodium disulfitoaurate(I) is increasingly being replaced by the corresponding ammonium salt, which provides special advantages with Au-Pd-Cu baths, such as the facility to produce very dense coatings.

### 23.7.4 Miscellaneous Gold Compounds [1, 20, 63]

Bright gold preparations (gold sulfureinates) are used for gilding ceramics and glass. Other compounds, some of which have applications in preparative and analytical chemistry, include gold(III) chloride  $\text{AuCl}_3$ , gold(I) chloride  $\text{AuCl}$ , gold(III) hydroxide  $\text{Au}(\text{OH})_3$  or  $\text{AuO}(\text{OH})$ , gold(III) oxide  $\text{Au}_2\text{O}_3$ , the gold sulfides  $\text{Au}_2\text{S}$ ,  $\text{AuS}$ , and  $\text{Au}_2\text{S}_3$ , gold(I) cyanide  $\text{AuCN}$ , and gold(I) acetylide  $\text{Au}_2\text{C}_2$ . Sodium dithiosulfatoaurate(I),  $\text{Na}_3[\text{Au}(\text{S}_2\text{O}_3)_2] \cdot 2\text{H}_2\text{O}$ , is used as a photographic sensitizer, and gold(III) selenate,  $\text{Au}_2(\text{SeO}_4)$ , for staining glass.

Gold compounds, particularly gold thiosulfate, gold mercaptides, and gold malate, have long been used for the treatment of rheumatic disease. The triethylphosphine gold complex of thioglucose tetraacetate, Auranofin, is very effective against chronic inflammation of joints. Gold(I) complexes of diphosphines may be beneficial in tumor therapy.

### 23.8 Alloys [1, 12, 20, 24, 31, 39, 79–90]

Gold forms alloys with many metals and metalloids. The most important alloys are composed of elements from the same group in the periodic table (Ag, Cu) and from the neighboring groups (Ni, Pd, Pt, less often Zn, Cd, Hg). The most frequently used elements, i.e., Ag, Cu, Ni, Pd, and Pt crystallize like gold with face-centered cubic unit cells, and coordination number 12. Thus, they readily form continuous solid solutions with gold, especially as their metallic atomic radii (Au 144.2 pm; Ag 144.5 pm; Cu 127.8 pm; Ni 124.6 pm; Pd 137.6 pm; Pt 137.3 pm) in certain cases are very similar. Zinc, cadmium, and mercury have metallic atomic radii of 133.5 pm, 148.9 pm and 150.3 pm, respectively. These metals all have hexagonal unit cells, which renders the formation of alloys with gold more complex.

The practical uses of gold alloys and of fine gold are mainly determined by their color,

hardness, corrosion resistance, melting point, and relative value. The degree of hardness can be controlled by heat treatment. The melting point plays a significant role during manufacture and processing.

For centuries, the color (Figure 23.7), hardness, and corrosion resistance of gold were modified by variations in the Au–Ag–Cu system. When white gold, with its resemblance to platinum, became fashionable at the beginning of this century, Ni and Pd were added; these were soon followed by Zn, and later by platinum. The gold alloys used for modern dental materials are complex because they must have specific properties.

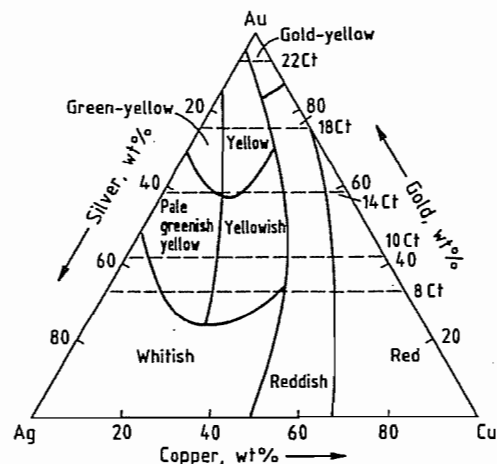

Figure 23.7: Gradation of color of gold-silver-copper alloys.

## 23.9 Quality Specifications and Analysis [20, 91, 92]

### 23.9.1 Quality Specifications [33]

The gold content of fine gold and gold alloys is usually expressed in fineness (parts per thousand) or in carat, where 24 carat represent 1000/000 fine, 18 carat thus being equal to 750/000. For ores, intermediate products, and older materials, the gold content is usually given in grams per metric tonne (g/t) (ppm), ounces per metric tonne (oz/t), and ounces per short ton, where 1 oz = 1 troy ounce = 31.1035

g and 1 short ton = 907.184 kg. Other units are 1 dwt = 1 pennyweight = 0.05 oz = 1.555 g and 1 troy grain = 1/24 dwt = 0.0648 g. 1 tola = 0.375 oz is an Indian measure for gold.

In general, marketable grades of gold are subject to the purity standards given in Table 23.2.

Table 23.2: Marketable gold qualities.

Designation	Gold content, %	Content of other metals, ppm
"Good delivery" gold	≥ 99.5	Any metals (total) ≤ 5000
Fine gold	≥ 99.99	Ag ≤ 100 Cu ≤ 20 others ≤ 30 total ≤ 100
Fine gold, chemically pure	≥ 99.995	Ag ≤ 25 others ≤ 25 total ≤ 50
Fine gold, high purity	≥ 99.999	Ag ≤ 3 Fe ≤ 3 Bi ≤ 2 Al ≤ 0.5 Cu ≤ 0.5 Ni ≤ 0.5 Pd + Pt ≤ 5.0 total ≤ 10

### 23.9.2 Sampling [93]

Accurate determination of gold depends on the use of correct sampling methods.

Exact procedures have been laid down for taking samples from ingots of raw gold, or from material separated in recycling processes. The samples may be taken by drilling, cutting, or sawing. As a rule, they are taken from several places in an ingot, which helps to avoid errors arising through possible segregation effects.

Powdered material is usually first screened to separate the fine from the coarse material. These are then subjected separately to a mechanical or manual sampling process.

Recycled electronic material usually contains only a few percent gold together with plastic and base metal components. Mechanical size reduction, e.g., in a shredder, or by cold grinding using liquid nitrogen, often produces material from which samples can be taken.

### 23.9.3 Quantitative Analysis

Quantitative analysis forms the basis for calculating the gold content of end products, intermediate products, gold ores, and recycling materials. The most important method for gold, as for silver, is still the centuries-old docimastic analysis, or docimasy (Greek: testing, assay), more commonly known as the fire assay. In this process, noble metals are taken up by molten lead, while base metals are removed by slagging. Two methods are used. In the *crucible assay*, a mixture of lead oxide, a reducing agent (e.g., carbon), and a flux is melted at ca. 1250 °C. In the *scorification assay*, the sample is subjected to oxidative smelting with grain lead and borax at ca. 1000 °C. In each case, a bead of lead containing gold and other noble metals is formed. The lead is then oxidized at ca. 800 °C to litharge (PbO) on a magnesia bed (cupellation process). The PbO melt is absorbed by the porous magnesia and a drop of noble metal, which later solidifies to a grain, remains behind. If the grain contains platinum-group metals in addition to gold, then a chemical or physical analysis follows. Reductive precipitation followed by weighing the gold is the most common method. X-Ray fluorescence analysis of the grain has the advantage of greater speed and economy [94, 95].

In the gold trade, docimasy is the generally accepted method for determining gold. Annual mercantile transactions worth ca. DM  $40 \times 10^9$  are based on the results of docimastic analyses. Determination of the gold content of high-percentage alloys using physical methods has not been accepted, because it is not sufficiently accurate. The gold content of fine gold can be determined far more accurately from the sum of the impurities than by direct determination of the noble metal content.

### 23.9.4 Purity Analysis

Purity tests for commercial gold are today almost exclusively carried out by physical methods, the most important being emission spectrography, plasma emission spectrogra-



phy, and atomic absorption spectroscopy. In special cases, mainly for ultrapure materials, mass spectroscopy, glow discharge, and neutron activation are used. Physical methods have largely replaced chemical and colorimetric methods in the determination of trace impurities for reasons of economy and speed.

### 23.9.5 Trace Analysis

The determination of trace amounts of gold is important in ore prospecting and in the evaluation of residues and waste materials from the metallurgical industry. The gold content of these materials may be very low (ca. 1–1000 ppm). The solids can be dissolved and the resulting solution analyzed by atomic absorption spectroscopy. The solution can be enriched prior to the determination, if required, by solvent extraction. Alternatively, metallic gold can be collected in molten copper or lead. The resulting alloy can then be dissolved and the solution analyzed by atomic absorption spectroscopy. The solid alloy can be analyzed by neutron activation, total reflection X-ray fluorescence, and inductively coupled plasma mass spectroscopy. Fire assaying is also still significant in this field.

## 23.10 Uses of Gold and Gold Alloys [6, 12, 19, 20, 24, 31, 33, 39, 41, 96]

### 23.10.1 Coins, Medals, Bars [97]

In antiquity, gold was considered an object of value and used as a means of exchange, at first in the form of nuggets or flattened disks, and from 650 B.C. as minted coins. The composition of the metal used varied from alloys containing a high proportion of gold, to electrum which had a relatively high silver content. The confusing variety of gold coins, and the great variation in fine gold content, was first limited in the 19th century, when legal regulations were introduced for coinage, which specified nominal values of gold coins, their weight, and gold content. After World War I, gold coins were no longer legal tender.

They are now traded as collectors' items and as a form of investment. With the liberalization of private gold trading in the 1950s, the demand for gold increased. A successful new enterprise in this market was the minting and marketing of the krugerrand (gold content of 1 oz troy) by South Africa. Between 1967 and 1985, a total of 2000 t (ca.  $65 \times 10^6$  oz) were sold. Following the repressive measures which have been inflicted on the krugerrand, new coins were introduced by other countries (Table 23.3).

Gold was already stored in the form of bars in antiquity, especially in Rome. Today, gold bars weighing ca. 400 oz (ca. 12 kg) of good delivery quality (99.5%) are the main form used in public and institutional investment. Gross weight, gold content, the manufacturing firm and reference number are stamped on the bars, and provide direct and binding information as to their value. Smaller gold bars are manufactured for private investors.

The difference between the buying and selling price in banks (broker's commission) is normally ca. 3–4% plus value added tax.

### 23.10.2 Jewelry [98]

**Fine Content of Jewelry Gold.** The gold value of jewelry alloys is determined by their gold content (fineness). In most countries, laws govern the terms used in designating the fineness of gold jewelry for manufacturers, processors, and dealers.

Only alloys with a minimum gold content of 585/000 are sufficiently tarnish resistant for jewelry. Better quality jewelry customarily has a gold content of 750/000. These alloys offer optimum color and mechanical properties. For less expensive jewelry, alloys with a low gold content are often used. In Germany, 333/000 fine is common, and in the United States 417/000. These alloys tarnish under unfavorable conditions, and cracks may form as a result of stress corrosion. The highest grade alloys are used only occasionally in the manufacture of jewelry, due to their low strength. However, no alloy can match the fine color of pure gold.

Table 23.3: Coinage alloys.

Coin	Country	Mintage period	Fineness	Carat	Gross weight, g	Gold content
20 mark	German Reich	1871–1915	900	21.6	7.964	7.168
10 mark			900	21.6	3.982	3.584
5 mark			900	21.6	1.991	1.792
1 ducat	German Confederation	up to 1871	986.1	23.7	3.490	3.441 g
Krugerrand <sup>a</sup>	South Africa	since 1967	916.6	22	33.931	1 oz
Maple Leaf <sup>a</sup>	Canada	since 1979	999.9	24	31.103	1 oz
American Eagle <sup>a</sup>	United States	since 1986	916.6	22	33.931	1 oz
Britannia <sup>a</sup>	Great Britain	since 1987	916.6	22	33.931	1 oz
Nugget <sup>a</sup>	Australia	since 1987	999.9	24	31.103	1 oz
Tscherwonez	Former USSR	since 1975	900	21.6	8.60	7.74 g

<sup>a</sup> Also in  $\frac{1}{2}$ ,  $\frac{1}{4}$ , and  $\frac{1}{10}$  oz gold.

Table 23.4: Composition of gold alloys for jewelry.

	Gold content, %	Content of alloy components, %
<i>Colored gold</i>		
20 carat	88.3	Ag 0–16.7, Cu 0–16.7
18 carat	75	Ag 0–20, Cu 5–25
14 carat	58.5	Ag 8–34, Cu 7.5–33.5
8 carat	33.3	Ag 8qP35, Cu 30–55, Zn 0–20
<i>White gold</i>		
18 carat	76	Cu 4–8, Ni 10–18, Zn 3–6
18 carat	75	Pd 10–20, Cu + Zn 5, rest Ag
14 carat	59	Cu 15–25, Ni 10–16, Zn 5–8

**Colored gold alloys** used in the jewelry industry are mostly based on the ternary alloy system Au–Ag–Cu, allowing a wide variety of colors. The workability and resistance to wear of an alloy depend on its mechanical properties; these, and its resistance to corrosion, can be controlled by adding zinc. The classification ranges for colored gold alloys used in the jewelry sector are shown in Table 23.4. To designate the different qualities, special codes are used, most of which are specific to particular firms. The properties cover a broad range of values to meet all practical requirements (Table 23.5). In 1966 in Germany, an industrial standard, DIN 8238 “Gold colors” (including white gold), was created to standardize colors in gold alloys and to provide manufacturers with a better means of mutual understanding. This standard closely reflects similar specifications in Switzerland

and France. A combination of values representing tone (T), saturation level (S), and darkness (D), measured using spectrophotometric methods, is attributed to each color (Table 23.6).

**Gold Solders.** The most frequently used method of making joins in the manufacture of jewelry from gold alloys is hard soldering. In addition to fine gold, colored gold solders also contain silver, cadmium, copper, and zinc. Their melting temperature is always lower than that of the material to be soldered. The additives are adjusted so that the solders have graduated working temperatures. Three solders are generally sufficient, with graduations of ca. 50 °C in their working temperatures. Some examples of colored gold solders are given in Table 23.7.

**White gold alloys** were first developed in the early 1900s, in an effort to replace platinum by a cheaper material with identical properties. White gold also differs from colored gold in having a higher melting range and is usually harder. Nickel and palladium are the only suitable additives to give gold a color approaching whitish-gray. The demand for white gold has fallen in the last few years in favor of colored gold and platinum. Information about white gold alloys is given in Table 23.4.

Table 23.5: Properties and applications of jewelry gold alloys.

Carat	Designation	Color	Melting range, °C	Density, g/cm <sup>3</sup>	Brinell hardness (after soft annealing), kg/mm <sup>2</sup>	Rings, brooches	Deep pulling work	Pressing work	Enamelling	Castings	Chains, lattice work	Blanks for minting	Bracelets	Wedding ring blanks	Pipes, seamless
<i>Colored gold</i>															
18 ct	750/2	red	880-865	15.0	140 hard	•									
	750/4½	reddish	875-850	15.3	125 medium hard	•									
	750 150	pale yellow	900-850	15.5	120 medium hard	•	•	•		•	•	•	•	•	•
	750 130	yellow	890-850	15.5	125 medium hard	•	•	•		•	•	•	•	•	•
	750/10	pale yellow	970-900	15.8	85 soft		•	•				•			
14 ct	585/2	red	920-880	13.0	105 soft	•	•	•	•	•	•				
	585/4	reddish	905-860	13.1	125 medium hard	•									
	585/5 M	reddish yellow	860-790	13.2	120 medium hard	•				•		•	•		
	585/10	deep yellow	845-825	13.6	160 very hard									•	
	585/13	pale yellow	840-800	13.7	140 hard									•	
	585/15	pale yellow	890-820	13.7	125 medium hard	•	•	•	•	•	•	•	•	•	•
	585/17	green yellow	980-940	13.8	100 soft		•	•	•		•	•			
8 ct	333/4½	reddish	930-890	11.0	100 soft	•					•	•	•		
	333/6	pale yellow	845-770	10.9	90 soft	•	•	•			•	•			
	333/9	yellow	860-750	11.1	120 medium hard								•	•	•
	333/16	pale yellow	810-750	11.5	125 medium hard				•						
<i>White gold</i>															
18 ct	760 H	white contains Ni	950-875	14.8	185 very hard or hard	•				•					
	750 M	white contains Pd	1170-1040	16.0	110 medium hard or hard	•									
	750 S	white contains Pd	1170-1040	15.6	95 soft	•	•	•		•	•			•	
14 ct	590 H	white contains Ni	1000-870	12.8	150 hard	•				•				•	
	590 M	white contains Pd	1120-1060	14.1	130 medium hard or hard	•									
	590 S	white contains Pd	1150-1050	14.0	95 soft	•	•	•		•	•			•	

Table 23.6: Gold colors according to DIN 8238.

Symbol	German classification	Swiss and French classification	Colorimetric measures according to DIN 6164			Examples of approximately corresponding gold alloys
			T	S	D	
N	weiß		1.2	0.9	1.6	590 H
8 N	grügelb		24.8	1.6	1.2	585/17
1 N	blaußgelb	jaune pâle	1.7	1.7	1.2	585/15
2 N	hellgelb	jaune pâle	1.8	1.8	1.3	750/150
3 N	gelb	jaune	2.0	1.8	1.3	750/130
4 N	rosé	rosé	2.4	1.6	1.4	750/4½
5 N	rot	rouge	2.6	1.5	1.4	750/2

Table 23.7: Working temperatures of colored gold solders.

Gold content, carat	Solder designation (Degussa)	Working temperature, °C
18	L 750/3	820
	L 750/1:	750
	L 750/1	700
14	L 585/7	780
	L 585/8	720
8	L 585/3½	670
	L 333/15	700
	L 333/10½	640

### 23.10.3 Electronics and Electrical Engineering [99, 100]

Modern electronics require the use of noble metals, especially gold, particularly in the areas of information processing, telecommunications, and military and space electronics. It is used in active components (diodes, transistors, integrated circuits, semiconductor memories), assembly and connection engineering (packages, thick-film circuits, printed boards, and plugs) and, to a lesser extent, for passive components (capacitors and resistors).

The great advantage of gold is its high resistance to oxidation and corrosion, and its high conductivity which give it excellent contact properties. Gold plating is usually carried out by electrochemical deposition. Thin gold coatings can also be produced by firing of gold-containing pastes, usually coated on ceramics. Gold is very malleable, so that it can be worked into very thin bonding wires, usually with a diameter of ca. 25 µm. Fine gold wires can easily be welded to each other, or to other metals, by pressure or by a combination of heat and pressure. These microwelded joints can easily be made on microelectronic circuits at high speed.

Modern methods used in bonding chips require bumps on the contact surfaces of the crystal; these bumps are made from gold.

The gold used in electronics, with the exception of gold solders, is practically always fine gold of purity 99.99 or 99.999%. Very few parts are made of massive gold for reasons of economy.

Because of its high price, gold is not used a great deal in electrical engineering. Roll-bonded gold claddings, or gold coatings made by electrodeposition, are occasionally used for special contact problems. Gold-nickel and gold-silver alloys are used in weak-current engineering, as contact materials for very low voltage switches, and where the contact forces are low (relays, plugs, measuring instruments). Micromigration of these alloys is very low, and there is little tendency for insulating layers to form.

Gold-manganese alloys are used for wire-wound resistance thermometers. The thermocouples Cu + Au 99.4/Co 0.6 and Pt 90/Ir 10 + Au 60/Pd 40 are suitable for the temperature ranges 0 to -240 °C and 0 to 700 °C, respectively; the gold alloys form the negative leg.

### 23.10.4 Solders [101]

The eutectics of the following systems are used as solders for joining materials in transistor production technology: gold-tin (25% Sn, *mp* 280 °C), gold-silicon (30% Si, *mp* 370 °C), and gold-germanium (26% Ge, *mp* 350 °C).

Alloys of gold with tin or silicon are used to make hard solders with a low melting point, high corrosion resistance, good thermal and electrical conductivity, and high mechanical strength. Heat-sensitive components are soldered using these materials.

Certain types of apparatus have components made of iron and nickel alloys which have to withstand high vacuums and high temperatures. To join these materials, vacuum hard solders are used, made of either fine gold, or gold-copper, gold-silver-copper, gold-nickel, gold-copper-nickel, and gold-palladium alloys. Soldering is carried out in a vacuum furnace or in a protective gas (hydrogen, cracked gas).

Hard silver solder is normally used to join stainless steels. However, if these joints do not exhibit sufficient corrosion resistance, gold-nickel-zinc alloys similar to white gold, with ca. 80% gold, 15% nickel, and 5% zinc, are occasionally used.

### 23.10.5 Pen Nibs

Nibs for fountain pens are usually made from Au-Ag-Cu yellow gold alloys which are relatively hard; occasionally white gold alloys are also used. The alloys must be able to withstand the very corrosive ferro-gallic inks; only 14 or 18 carat alloys are suitable. The nib points must be made of hard metal alloys, which usually contain Ru, Os, Ir, W, or Co.

Nibs made of stainless, ink-resistant nickel chromium steel are sometimes coated with a thin layer of gold; however, this does not improve their ink resistance.

### 23.10.6 Chemical Technology [102]

Gold-platinum alloys containing 50–70% gold, which can be age-hardened, are used to make spinnerets used in the production of man-made fibers. Their fine-grained structure is of great advantage in making the necessary fine holes (diameter 25–120  $\mu\text{m}$ ).

Gold alloys are sometimes used for seals and rupture disks that come into contact with corrosive substances. A gold-silver-palladium alloy (Pallacid) containing 30% gold and 30% palladium is resistant to strong mineral acids, is considerably cheaper than gold, and also has greater high-temperature strength.

A gold alloy containing 10% platinum is used to make crucibles for analytical laboratories, e.g., for ash determination of flour and other phosphorus-containing foods. Unlike platinum crucibles, it is resistant to corrosion by phosphorus compounds when red-hot.

### 23.10.7 Dental Materials

Gold alloys are of great importance in prosthetic dentistry, for solid parts such as gold fillings, crowns, bridges, cast dentures, clasps, anchorage pins, and metal bases for dental ceramics. These materials have to meet a number of requirements. They must be resistant to normal conditions in the mouth, of a suitable color, of different strengths, and be easy to work. Today almost all alloys used are of a complex composition, containing high proportions of gold, palladium, and platinum. The advantage of these alloys mainly lies in their very fine-grained and homogeneous structure.

### 23.10.8 Coatings [103–105]

The technical and decorative properties of gold can be combined with a variety of cheap

base materials, by applying a thin layer of gold to base metals, ceramics, glass, or plastics.

**Electroplating** is by far the most frequently used method. In most cases, gold is separated from an electrolyte containing potassium dicyanoaurate. Occasionally, electroplating baths containing sodium disulfiteaurate or cyanide complexes of trivalent gold are used.

**Electroforming** is used to manufacture cheap hollow jewelry. Gold up to a thickness of 0.2 mm is deposited on a mandrel. The mandrel is then removed; wax mandrels can be melted out. A self-supporting gold layer is left, which can be reinforced by a filler material.

**Bright Gold.** Ceramic materials, especially high-quality porcelain and glass, are often gilded by firing on preparations of bright gold and burnished gold. The essential components of these lacquer-like paints are gold sulfosinates, mixed with natural oils and resins. The colors are applied either by hand, or by screen or offset printing processes. Firing is carried out at 500–1250 °C. Gold coatings for technological applications also may be applied by this method.

**Rolled gold** is still used for spectacle frames and gold-plated watches. However, it has lost its former significance in favor of electroplating. Rolled gold is fabricated by soldering gold sheets, usually 14 carat, to blocks made of copper alloy or stainless steel. These are then rolled or drawn to the desired shape, producing strips and wires with a largely non-porous gold coating, usually 510  $\mu\text{m}$  thick.

**Fire Gilding.** In this process, the part to be gilded is painted with gold amalgam. The mercury is evaporated by heating, leaving a relatively thick gold layer. The process is very problematical with regard to industrial hygiene.

**Vapor Deposition of Gold.** Glass panes can be insulated against loss of heat, through reflection of infrared rays, by applying very thin layers of gold in a sputtering process (cathode evaporation). Plastic components can be thinly gilded by sputtering in a vacuum.

Gilded films are also used in space technology, e.g., in space suits, to produce reflective coatings and thus protect against heat.

### 23.10.9 Gold Leaf

Gold leaf is usually made of fine gold or Au-Ag-Cu alloys with a very high gold content. The crystal plane  $\langle 100 \rangle$  in beaten gold leaf lies in the plane of the leaf. Gold leaf is used to gild wooden statues, book edges, and fabric prints. In certain beverages (Danziger Goldwasser), and recently also in some foods, it is used to achieve visual effects.

In former times, small rolls of gold leaf were used to fill cavities in teeth.

### 23.10.10 Catalysts

Gold is of almost no significance as a catalytically active metal. It is occasionally used as an additive in platinum-group metal or silver-based catalysts.

Platinum vapor, which forms from platinum-rhodium catalysts during the oxidation of ammonia to nitric acid can be retained by a gold or gold-palladium gauze. This process has long been in industrial use.

## 23.11 Economic Aspects [2, 4, 18–20, 33, 34, 41, 106–111]

**Production.** Gold represents a significant portion of the total world economy. In South Africa, it occupies in terms of value the highest position among all industrial goods. Over 500 000 people are employed worldwide in gold production. The value of the gold from primary production in 1987 was DM  $32 \times 10^9$ . Thus it occupies third place in the metal trade, after pig iron (DM  $200 \times 10^9$ ) and aluminum (DM  $45 \times 10^9$ ), and before copper (DM  $22 \times 10^9$ ).

At present, almost half of the gold obtained from ores is produced in South Africa. Brazil, the United States, Canada, and Australia are currently expanding production. Since the dis-

covery of the large Brazilian deposits around 1970 and the new activities of other producer countries, the supply is more balanced and less dependent on political constellations than it used to be. Table 23.8 shows the primary production of gold in the various producer countries.

**Supply and Demand.** As a consequence of the free market, the supply and demand for gold are on the whole quite well balanced. High prices are regulated by reduced consumption, especially in the jewelry sector, and in investment purchases, as well as through the replacement of noble metals used in technology by other materials. The price is also reduced by the expansion of primary production and recycling, as well as by reductions in stocks. Low prices then cause an increase in demand, renewed reductions in primary and secondary production (often because profitability sinks too low), and accumulation of reserves.

The supply of gold on the market in 1987 was about 2000 t/a (Figure 23.8). Most of this (65%) came from Western mine production, 20% came from recycling processes, and 15% was sold by Eastern-bloc countries. Buying and selling on the part of government monetary authorities can have a strong effect on the market; at the present time, however, this effect is insignificant. The same applies to the sale of private stocks.

Figure 23.9 shows the demand for gold according to applications.

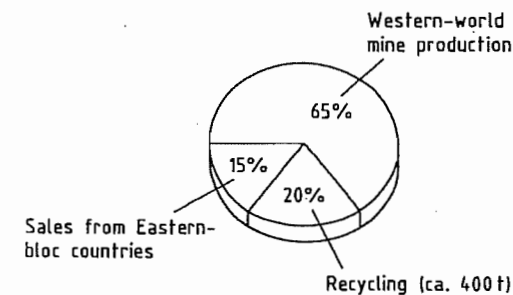

Figure 23.8: Gold supply in 1987 (ca. 2000 t).

Table 23.8: Primary gold production in various producer countries, t.

Country	1900	1930	1940	1950	1960	1970	1975	1980	1985	1986	1987
South Africa	10	333	437	363	665	1000	713	675	672	640	607
United States	119	69	150	74	46	54	32	31	80	118	155
Canada	4	65	165	138	143	75	52	52	52	106	120
Australia	110	19	66	29	35	20	16	17	59	75	108
Brazil	4	"	"	"	"	9	12	35	72	67	84
Philippine Islands	"	"	"	"	"	19	16	22	37	40	40
Papua/New Guinea	0	"	"	"	"	1	18	14	31	36	34
Colombia	3	"	20	13	14	7	11	17	26	27	26
Chile	"	"	"	"	"	"	4	7	18	19	19
Venezuela	"	"	"	"	"	"	"	1	12	15	16
Zimbabwe (Rhodesia)	3	17	25	16	18	15	11	11	15	15	14
Japan	2	11	26	0	11	8	5	7	9	14	14
Zaire (Congo)	0	4	15	11	10	6	4	3	8	8	12
Ghana (Gold Coast)	1	8	28	21	27	22	16	11	12	12	12
Peru	"	"	"	"	"	3	3	5	11	11	11
Mexico	14	21	28	12	9	6	5	6	8	8	8
Dominican Republic	"	"	"	"	"	0	3	12	10	9	8
Bolivia	"	"	"	"	"	"	"	2	6	6	6
India	16	10	9	6	5	3	3	3	2	2	2
Others	64	43	151	67	71	22	19	30	55	48	78
Former Soviet Union	30 <sup>b</sup>	27	140	138	143	336	407	c	c	c	c
Other Eastern-bloc countries	"	"	"	"	"	18	20	c	c	c	c
Total	390	627	1260	900	1200	1624	1370	1400	1600	1600	1700

<sup>a</sup>Included in others.

<sup>b</sup>Imperial Russia.

<sup>c</sup>Data withheld.

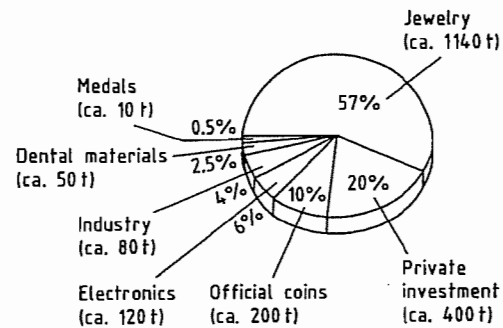

Figure 23.9: Gold demand in the western world in 1987 (ca. 2000 t).

**Gold Trade.** London is the most important market for gold in terms of the quantity traded. The London gold market has a fixing system, whereby the price of gold is determined twice daily, according to supply and demand, by representatives from five firms of brokers. This is then published as the "fixed price". The United States futures markets have a strong influence on the calculation of this price. The fixed price serves as an orientation point for gold traders all over the world.

Zürich is also an important center of the gold trade, and is comparable to London in terms of quantity. A considerable part of the gold from South African primary production, which up to 1968 all went to London, is now sold to Zurich, as well as most of the gold from the former Soviet Union.

Other important centers are New York and Chicago. Other metal exchanges, such as Hong-Kong, Frankfurt, Paris, Singapore, and Tokyo, are of more regional importance.

Gold is traded internationally in the form of gold bars of various weights, and with a gold content of 99.50–99.99%. In London, gold bullion must contain gold weighing between 350 and 430 oz; the commonest figure is about 400 oz (ca. 12 kg).

Important factors which influence the price of gold are assessment of political circumstances, inflation rates, and the rate of interest of the US dollar as a key world currency. The huge gold holdings of the issuing banks (ca. 30 000 t) could have a great effect on the price of gold, if anything were to change in the

present role of gold in the monetary system. Today its role is limited to providing backing for credits and partially for the current money, and to the procurement of foreign exchange through sales.

On July 19th, 1989, the price of gold was \$370 per ounce (DM 23.20 per gram).

## 23.12 Toxicology and Occupational Health [112, 113]

Gold, even if finely divided, has no effect on living organisms. Like most soluble heavy metal salts, compounds of trivalent gold, especially the complexes, have a toxic effect when they enter into the metabolism. In the case of gold, however, only the side-effects of clinical gold therapy for arthritis are known in this connection. The side effects include kidney and liver damage, stomatitis, and hematopoietic disorders [114].

Tetrachloroauric acid,  $H[AuCl_4]$  in aqueous solution is a strong acid, and can thus have a caustic effect. In contact with the skin, the compound is reduced to elemental gold and becomes red. The complex  $K[Au(CN)_2]$  is toxic due to its cyanide content. Neither MAK, TLV, nor ADI values have been established for gold and its compounds.

## 23.13 References

- Gmelin, System no. 62.
- H. Quring: *Die metallischen Rohstoffe*, 2nd ed., vol. 3 "Gold", Enke Verlag, Stuttgart 1953.
- Degussa, *Sol & Luna – auf den Spuren von Gold und Silber*, Frankfurt 1973.
- B Neumann: *Die Metalle – Geschichte, Vorkommen und Gewinnung nebst ausführlicher Produktionsstatistik*, Verlag Wilhelm Knapp, Halle 1904.
- H. Moesta: *Erze und Metalle – ihre Kulturgeschichte im Experiment*, Springer Verlag, Berlin 1983.
- H. Römpf: *Chemie der Metalle*, Franckh'sche Verlagshandlung, Stuttgart 1941.
- H. W. A. Sommerlatte: *Gold und Ruinen in Zimbabwe – aus Tagebüchern und Berichten des Schwaben Karl Mauch (1837–1875)*, Verlag Bertelsmann Fachzeitschriften GmbH, Gütersloh 1987.
- A. Hartmann, E. Sangmeister: "Zur Erforschung urgeschichtlicher Metallurgie", *Angew. Chem.* 84 (1972) 668–678.
- K. Löhberg: "Beiträge der Metallkunde zur Archäologie", *Jahrbuch 1979 der Berliner Wissenschaftlichen Gesellschaft e. V.*, p. 48.
- G. Biegel (ed.): *Das erste Gold der Menschheit*, Verlag Karl Schillinger, Freiburg 1986.
- F. Kirchheimer: "Über das Rheingold", *Jahreshefte des geologischen Landesamts Baden Würtemb.* 7 (1965) 77.
- World Gold Council, *Gold Bulletin – Quarterly review of research on gold and its applications in industry*, vol. 1 (1968)–vol. 22 (1989), Geneva.
- A. Binz: *Edelmetalle – ihr Fluch und Segen*, Limpert-Verlag, Berlin 1943.
- H. Pohl: *Gold – seine Macht und Magie in der Geschichte*, W. Heyne Verlag, München 1958.
- C. H. V. Sutherland: *Gold – Macht, Schönheit und Magie*, Verlag A. Schroll & Co., Wien–München 1970.
- G. Breitling et al.: *Das Buch vom Gold*, Verlag C. J. Bucher, Luzern–Frankfurt 1975.
- H. G. Fuchs: *Gold*, Fritz Knapp Verlag, Frankfurt 1981.
- P. Vilar: *Gold und Geld in der Geschichte*, Verlag H. C. Beck, München 1984.
- H. J. Funk (ed.): *Gold*, Edition Deutsche Bank, Battenberg Verlag, München 1986.
- Fonds der Chemischen Industrie, *Edelmetalle – Gewinnung, Verarbeitung, Anwendung, Folienserie*, Frankfurt 1989.
- A. Neuburger: *Die Technik des Altertums*, Voigtländer Verlag, Leipzig 1920, Prisma-Verlag, Gütersloh 1983.
- J. H. F. Notton, "Ancient Egyptian Gold Refining", *Gold Bulletin* 7 (1974) 50–56.
- V. Tafel: *Lehrbuch der Metallhüttenkunde*, vol. 1, S. Hürzel Verlag, Leipzig 1951.
- Degussa, *Edelmetall-Taschenbuch*, Frankfurt 1967.
- Doduco, *Datenbuch*, Pforzheim 1974.
- R. C. Weast: *Handbook of Chemistry and Physics*, 69th ed., CRC-Press, Cleveland 1989.
- D'Ans-Lax: *Taschenbuch für Chemiker und Physiker*, Springer Verlag, Berlin 1967.
- D. G. Cooper: *Das Periodensystem der Elemente*, Taschentext Nr. 6, Verlag Chemie, Weinheim 1972.
- G. H. Aylward, T. J. V. Findlay: *Datensammlung Chemie*, Taschentext Nr. 27, Verlag Chemie, Weinheim 1975.
- F. Fluck, K. G. Heumann: *Periodic Table of the Elements*, VCH Verlagsgesellschaft, Weinheim 1986.
- E. M. Wise: *Gold—Recovery, Properties and Application*, Van Nostrand, New York 1964.
- C. E. Wicks, F. E. Block: *Thermodynamic Properties of 65 Elements – their Oxides, Halides, Carbides, and Nitrides*, Bureau of Mines Rep. No. 605, Washington, DC, 1963.
- W. Gocht: *Handbuch der Metallmärkte*, 2nd ed., Springer Verlag, Berlin 1985.
- R. Saager: *Metallische Rohstoffe von Antimon bis Zirkonium*, Bank Vontobel, Zürich 1984.
- J. Lurie: *South African Geology for Mining, Metallurgical, Hydrological and Civil Engineering*, McGraw-Hill, Johannesburg 1981.
- C. B. Coetzee: *Mineral Resources of the Republic of South Africa*, Pretoria, Department of Mines, 1976.

37. H. Schneiderhöhn: *Erzlagerstätten*, G. Fischer Verlag, Stuttgart 1962.
38. R. Jackson: *Ok Tedi – The Pot of Gold*, World Publishing Co., Boroko, Papua-New Guinea, 1982.
39. *Kirk-Othmer*, 3rd ed., 11, pp. 972–995.
40. F. Pawlek: *Metallhüttenkunde*, de Gruyter, Berlin 1983.
41. Wilmacher-Küchler, 3rd ed., 4, 544–547.
42. *Ullmann*, 3rd ed., 8, pp. 269–284.
43. G. Agricola, *Vom Berg- und Hüttenwesen*, DTV-Verlag, München 1980.
44. D. Meadows, E. Zahn, P. Milling: *Die Grenzen des Wachstums*, Deutsche Verlagsanstalt, Stuttgart 1972.
45. R. J. Adamson (ed.): *Gold Metallurgy in South Africa*, Chamber of Mines, Johannesburg 1972.
46. J. V. N. Dorr, F. L. Bosqui: *Cyanidation and Concentration of Gold and Silver Ores*, McGraw-Hill, New York 1950.
47. A. King: *Gold Metallurgy on the Witwatersrand*, Chamber of Mines, Johannesburg 1949.
48. D. M. Liddell: *Handbook of Nonferrous Metallurgy*, McGraw-Hill, New York 1955.
49. T. K. Rose, W. A. C. Newman: *The Metallurgy of Gold*, Griffin, London 1937.
50. E. A. Cho, S. N. Dixon, C. H. Pitt: "The Kinetics of Gold Cyanide Adsorption onto Activated Charcoal", *Metall. Trans. B* 10B (1979), 185–189.
51. A. S. Dahya, D. J. King: "Developments in Carbon-in-Pulp Technology for Gold Recovery", *CIM Bull.* 76 (1983) no. 857, 55–61.
52. C. A. Fleming: "Some Aspects of the Chemistry of Carbon-in-Pulp and Resin-in-Pulp Processes", in *papers presented at The Australasian Institute of Mining and Metallurgy, Seminar on Carbon-in-Pulp Technology for the Extraction of Gold*, Kalgoorlie (Australia), July 1982.
53. C. A. Fleming in K. Osseo-Assare, J. D. Miller (eds.): *Hydrometallurgy: Research, Development and Plant Practice*, "Recent Developments in Carbon-in-Pulp Technology in South Africa", The Metallurgical Society of AIME, Warrendale, PA, 1983, pp. 839–858.
54. C. A. Fleming, M. J. Nicol: "The Adsorption of Gold Cyanide onto Activated Carbon III. Factors Influencing the Rate of Loading and the Equilibrium Capacity", *J. S. Afr. Inst. Min. Metall.* 84 (1984) no. 4, 85–93.
55. C. A. Fleming, M. J. Nicol, D. J. Nicol: "The Optimization of a Carbon-in-Pulp Adsorption Circuit Based on the Kinetics of Extraction of Aurocyanide by Activated Carbon", *paper presented at the Symposium: Ion Exchange and Solvent Extraction in Mineral Processing held at Mintek*, Randburg, Feb. 1980.
56. P. A. Laxen, G. S. M. Becker, R. Rubin: "Developments in the Application of Carbon-in-Pulp for Gold Recovery from South African Ores", *J. S. Afr. Inst. Min. Metall.* 79 (1979) no. 11, 315–326.
57. P. A. Laxen, T. D. Brown in L. F. Haughton (ed.): *Mintek 50: Proceedings of the International Conference on Mineral Science and Technology*, "The Carbon-in-Pulp Plant at Rand Mines Mining and Mining Company Limited: Problems and Development", vol. 2, Council for Mineral Technology, Randburg 1985, pp. 695–706.
58. P. A. Laxen, C. A. Fleming, D. A. Holtum, R. Rubin in H. W. Glen (ed.): *Proceedings, Twelfth Congress of the Council of Mining and Metallurgical Institutions*, "A Review of Pilot-Plant Testwork Conducted on the Carbon-in-Pulp Process for the Recovery of Gold", vol. 2, The South African Institute of Mining and Metallurgy, Johannesburg 1982, pp. 551–561.
59. G. J. McDougall, R. D. Hancock: "Gold Complexes and Activated Carbon. A Literature Review", *Gold Bull.* 14 (1981) no. 4, 138–153.
60. M. J. Nicol, C. A. Fleming, G. Cromberge: "The Adsorption of Gold Cyanide onto Activated Carbon. I. The Kinetics of Adsorption from Pulp", *J. S. Afr. Inst. Min. Metall.* 84 (1984) no. 2, 50–54.
61. M. J. Nicol, C. A. Fleming, G. Cromberge: "The Adsorption of Gold Cyanide onto Activated Carbon. II. Application of the Kinetic Model to Multistage Absorption Circuits", *J. S. Afr. Inst. Min. Metall.* 84 (1984) no. 3, 70–78.
62. D. F. Williams, D. Glasser: "The Modelling and Simulation of Processes for the Absorption of Gold by Activated Charcoal", *J. S. Afr. Inst. Min. Metall.* 85 (1985) no. 8, 237–243.
63. G. Brauer: *Handbuch der Präparativen Anorganischen Chemie*, vol. 2, 3rd ed., Enke Verlag, Stuttgart 1978.
64. Chamber of Mines (ed.): *Rand Refinery*, P.R.D. Series No. 149, Johannesburg 1970.
65. G. Eger: *Das Scheiden der Edelmetalle durch Elektrolyse*, W. Knapp Verlag, Halle 1929.
66. M. Fiberg, I. R. Edwards: *The Extraction of Gold from Chloride Solutions*, Report No. 1996, National Institute for Metallurgy, Randburg 1978.
67. W. W. Behning, *Metall (Berlin)* 24 (1970) 794.
68. E. Krone, W. Dähne, *Chem. Ztg.* 101 (1977) 421.
69. G. Comelius, *Erzmetall* 32 (1979) 467.
70. *Recycling – Rohstoffsicherung und Umweltschutz*, Degussa, Frankfurt (M) 1981.
71. F. H. Burstall, P. J. Forrest, R. A. Wells, *Ind. Eng. Chem.* 45 (1953) 1648–1658.
72. K. B. Ball, *World Min.* 27 (1974) no. 11, 44–45.
73. R. J. Puddephatt: *The Chemistry of Gold*, Elsevier, Amsterdam 1978.
74. G. Wilkinson, R. D. Gillard, J. A. McCleverty: *Comprehensive Coordination Chemistry*, vol 5, Pergamon Press, Oxford 1987.
75. G. Wilkinson, F. G. A. Stone, E. Abel: *Comprehensive Organometallic Chemistry*, vol. 2, Pergamon Press, Oxford 1982.
76. N. N. Greenwood, A. Earnshaw, *Chemistry of the Elements*, Pergamon Press, Oxford 1984; German: *Chemie der Elemente*, VCH-Verlagsgesellschaft, Weinheim 1988.
77. N. P. Finkelstein, R. D. Hancock: "A New Approach to the Chemistry of Gold", *Gold Bull.* 7 (1974) 72–77.
78. A. Prior: "Possibilities of Using Ion Exchange Membrane in the Recovery and Processing of Precious Metals", *Proceedings of the 11th International Precious Metals Institute Conference*, Brussels 1987.
79. E. Raub: *Die Edelmetalle und ihre Legierungen*, Springer Verlag, Berlin 1940.

80. E. Jäneke: *Kurzgefaßtes Handbuch aller Legierungen*, C. Winter Verlag, Heidelberg 1949.
81. J. L. Haughton, A. Prince: *The Constitution, Diagrams of Alloys. A Bibliography*, Institute of Metals, London 1956.
82. A. Prince: *Multicomponent Alloy Constitution, Bibliography 1955–1973*, Metals Society, London 1978.
83. A. Prince: *Multicomponent Alloy Constitution, Bibliography 1974–1977*, Metals Society, London 1981.
84. W. Home-Rothery, G. V. Raynor: *The Structure of Metals and Alloys*, Institute of Metals, London 1954.
85. M. Hansen: *Der Aufbau der Zweistoff-Legierungen*, Springer Verlag, Berlin 1936.
86. M. Hansen, K. Anderko: *Constitution of Binary Alloys*, 2nd ed., McGraw-Hill, New York 1958.
87. R. P. Elliott: *Constitution of Binary Alloys*, 1st Suppl., McGraw-Hill, New York 1965.
88. E. A. Shunk: *Constitution of Binary Alloys*, 2nd Suppl., McGraw-Hill, New York 1969.
89. W. G. Moffatt: *The Handbook of Binary Phase Diagrams*, General Electric Company, Schenectady, NY, 1976/77 (halbjährliche Nachträge).
90. G. Petzow, G. Effenberg: *Ternary Alloys*, vol. 1, 2, VCH-Verlagsgesellschaft, Weinheim 1988.
91. F. Ensslin: *Edelmetall-Analyse*, Springer Verlag, Berlin 1964.
92. Chemikerausschuß der GDMB (ed.): *Analyse der Metalle*, 2nd ed., Springer Verlag, Berlin 1961.
93. H. M. Lüschor: *Probenahme, Theorie und Praxis*, "Schriftenreihe d. GDMB", Verlag Chemie, Weinheim 1980.
- H. M. Lüschor, "Zur Probenahme von Edelmetallen. Teil 1: Probenahme von metallischen Materialien", *Erzmetall* 42 (1989) 153–159.
94. J. Suchomel, *Fresenius' Z. Anal. Chem.* 300 (1980) 257–266.
95. J. Suchomel, *Fresenius' Z. Anal. Chem.* 307 (1981) 14–18.
96. W. S. Rapson, T. Groenewald: *Gold Usage*, Academic Press, London 1978.
97. A. Luschin v. Ebengreuth: *Allgemeine Münzkunde und Goldgeschichte*, Oldenburg, München 1971.
98. World Gold Council, *Aurum – quarterly magazine for manufacturers, designers and retailers of gold jewelry*, no. 1 (1980), no. 31 (1987) Geneva.
99. E. Roser, *Handelsblatt-Magazin*, 1983, no. 12, 32–36.
100. A. Keil: *Werkstoffe für elektrische Kontakte*, Springer Verlag, Berlin 1960.
101. Degussa: "Technik die verbindet", *Berichte aus Forschung und Praxis*.
102. W. Funk, G. Reinacher: "Gold Alloy Spinnerets for the Production of Viscose Rayon", *Gold Bull.* 7 (1974) 2–9.
103. A. von Krusenstjern: *Edelmetall-Galvanotechnik*, Verlag Leuze, Saalgau 1970.
104. H.-D. Lachmann, H. G. Simanowski: *Gold als Oberfläche*, Leuze Verlag, Saalgau 1982.
105. Degussa: *Glanzgoldfibel*, Eigenverlag, Frankfurt 1979.
106. W. Knies, *Metall* 43 (1989) 651–653.
107. International Gold Corp, *Krügerand Bulletin*, up to 1985, Geneva.
108. International Gold Corp., *Gold Letter*, since 1985, Geneva.
109. B. Bandulet: *Gold Guide*, Fortuna Finanz-Verlag, Niederglatt/Zürich 1984.
110. K. Bolz, U. Harms, P. Pissulla, H. Schmidt: *Gold, Platinmetalle und Diamanten in der sowjetischen Handelspolitik*, Verlag Weltarchiv, Hamburg 1985.
111. H. Kutzer: *Metalle – zwischen Mangel und Überfluß*, Handelsblatt-Schriftenreihe, Düsseldorf 1981.
112. E. Merian: *Metalle in der Umwelt – Verteilung, Analytik und biologische Relevanz*, Verlag Chemie, Weinheim 1984.
113. E. Merian: *Metals and their Compounds in the Environment – Occurrence, Analysis, and Biological Relevance*, 2nd ed., VCH-Verlagsgesellschaft, Weinheim 1989.
114. N. O. Rothermich, V. K. Phillips, W. Berger, M. H. Thomas, *Arthritis Rheum.* 19 (1976) 1321.
115. G. G. Stanley (ed.): *The Extractive Metallurgy of Gold in South Africa*, The South African Institute of Mining and Metallurgy, Johannesburg 1987.
- E. Krone, "Probleme der Primärgoldlaugung", *Erzmetall* 42 (1989) 253–258.

## 24 Silver

HERMANN RENNER

24.1	History	1216	24.5.5	Via Scrap Metal Electrolysis	1236
24.1.1	Production	1217	24.5.6	Processing of Flue Dust	1236
24.1.2	Monetary Significance and Price Structure	1218	24.5.7	Processing of Copper Matte	1237
24.2	Properties	1219	24.5.8	Processing of Photographic Materials	1237
24.2.1	Atomic Properties	1219	24.5.9	Surface Desilvering	1239
24.2.2	Physical Properties	1219	24.5.10	Processing of Special Scrap	1240
24.2.3	Chemical Properties	1219	24.6	Silver Refining	1240
24.3	Occurrence and Raw Materials	1220	24.6.1	Fine Smelting	1240
24.3.1	Formation, Abundance, and Distribution of Ores	1220	24.6.2	Refining with Nitric Acid (Inquartation)	1240
24.3.2	Silver Minerals	1221	24.6.3	Refining with Sulfuric Acid (Affination)	1241
24.3.3	Deposits	1222	24.6.4	Möbius Electrolysis	1241
24.3.4	Secondary Silver	1223	24.6.5	Balbach-Thum Electrolysis	1242
24.3.5	Resources and Reserves	1224	24.7	Inorganic Compounds	1242
24.4	Extraction from Ores	1224	24.7.1	Silver Nitrate	1242
24.4.1	Extraction from Silver Ores	1224	24.7.2	Silver Halides	1244
24.4.1.1	Smelting	1224	24.7.3	Silver Oxides	1245
24.4.1.2	Amalgamation	1224	24.7.4	Other Soluble Silver Compounds	1246
24.4.1.3	Cyanidation	1225	24.7.5	Other Insoluble Silver Compounds	1246
24.4.1.4	Thiosulfate Leaching (Patera Process)	1225	24.7.6	Silver Complexes	1247
24.4.1.5	Metallurgical Processes	1226	24.7.7	Explosive Silver Compounds	1247
24.4.2	Extraction from Lead and Lead-Zinc Ores	1226	24.8	Disperse Silver	1248
24.4.2.1	Production of Lead Bullion	1226	24.8.1	Silver Powder	1248
24.4.2.2	Cupellation without Prior Silver Enrichment	1226	24.8.2	Colloidal Silver	1250
24.4.2.3	Silver Enrichment by the Pattinson Process	1226	24.9	Uses	1251
24.4.2.4	Silver Enrichment by the Parkes Process	1227	24.9.1	Coins	1251
24.4.2.5	Cupellation of Enriched Lead	1227	24.9.2	Jewelry	1252
24.4.2.6	Silver Extraction from Electrolytic Lead Refining	1228	24.9.3	Medicine	1252
24.4.3	Extraction from Copper and Copper-Nickel Ores	1228	24.9.4	Dentistry	1253
24.4.3.1	Formation of Silver-Containing Copper Anode Slimes	1228	24.9.5	Silver Plating	1253
24.4.3.2	Pretreatment of Copper Anode Slimes	1228	24.9.6	Electrical Technology	1255
24.4.3.3	Processing of Copper Anode Slimes	1229	24.9.7	Chemical Equipment	1257
24.4.3.4	Silver Extraction from Copper Matte	1231	24.9.8	Catalysts	1257
24.4.4	Extraction from Gold Ores	1232	24.9.9	Photography	1258
24.4.5	Extraction from Tin Ores	1232	24.9.10	Other Uses	1258
24.5	Recovery from Secondary Silver	1232	24.10	Quality Specifications and Analysis	1259
24.5.1	Via Copper Smelters	1233	24.10.1	Qualitative Analysis	1260
24.5.2	Via Lead Smelters	1233	24.10.2	Quantitative Analysis and Accountancy Analysis	1260
24.5.3	Via the Lead-Silver Smelting Process	1233	24.10.3	Purity Analysis	1261
24.5.4	Via Scrap Metal Leaching	1235	24.10.4	Trace Analysis	1262
			24.10.5	Argentometry	1262
			24.11	Economic Aspects	1262
			24.11.1	Production	1262
			24.11.2	Supply and Demand	1262
			24.11.3	Silver Market and Trading	1263

24.12 Health and Safety .....	1263	24.12.3 Explosion Hazards .....	1264
24.12.1 Toxicology .....	1263	24.13 References .....	1265
24.12.2 Bactericidal (Oligodynamic) Effect .....	1264		

## 24.1 History

**Ancient Times** [1–6]. Like gold, silver occurs in native form and therefore has been known to humans since prehistoric times. The oldest finds of silver whose age can be determined date from around 4157 B.C. in Egypt. In the following years, silver appeared in the entire cultural region of the eastern Mediterranean. In the second millennium B.C., the Phoenicians obtained large quantities of silver from deposits on the Iberian Peninsula, which were distributed by their companies of traveling merchants.

The first upsurge in the production of silver took place when the Greeks exploited the mines of Laurion, which reached their peak productivity in ca. 500 B.C. The Greeks also worked silver mines in Thrace, Asia Minor, and the entire Aegean region. The Athenian empire and its claim to power were based to a large extent on the role of silver for coinage. Modern methods of trace analysis have elucidated the relationship between the extraction and processing of the Greek silver deposits and their effects on the political developments at that time [7–11].

Rome was initially poor in silver. However, considerable quantities were soon obtained in the provinces that fell to the Roman Empire (i.e., southern Spain, the Balkans, the Carpathians, etc.). In many Roman expeditions of conquest (e.g., the Punic wars and those in the period of the civil wars), the seizing of silver mines was often a cause of war-like disputes. The introduction of the silver denarius as the common currency in ca. 300 B.C. elevated the political importance of the national metal.

Undoubtedly, silver was also extracted in pre-Christian times in middle and northern Europe, although this only became known through the Romans' written records. Likewise in India, China, and Japan the production of silver probably dates back to ancient times.

When the migration of the Germanic people began and the political dissolution of the Roman Empire occurred, silver production practically ceased. This situation changed with the reorganization of the western lands by the Carolingians.

**Middle Ages.** During the Middle Ages, the extraction of silver became widespread in central Europe. Some of the production locations are listed here, with their starting dates: Bohemia (Pribram: 753; Miss: 1137; Kuttenberg: 1240), Sweden (Sala: 8th century), Saxony (Freiberg: 1103; Mittweida and Frankenberg: 922), Erzgebirge (Joachimsthal: 1510; Annaberg, Schneeberg), Alsace (Markirch: 7th century), the Lahn region, Siegerland (ca. 860), Silesia (Beuthen, Tarnowitz), Hungary (Schemnitz), Norway (Kongsberg), Tyrol, Steiermark, Salzburg, the southern Black Forest (Freiburg im Breisgau), Harz Rammelsberg, which provided much of Europe's silver in the 11th and 12th centuries: 968; St. Andreasberg; Mansfeld, which was the source of most of the silver produced in Germany at that time: 1450).

Many of these deposits were exhausted by the end of the Middle Ages and often long before this. However, the mines in the Harz, Siebenbürgen, Freiberg, Norway, and Alsace retained some of their importance up to the industrial revolution.

The deposits in India, Japan, China, and pre-Columbian America, were also mined during the Middle Ages.

**Modern Times.** After the discovery of America, silver was plundered by the Spanish and brought to Europe in large quantities. Also, new deposits were developed. Soon, America was producing more silver than Europe, and prices collapsed. Up to ca. 1700, world production was dominated by Central and South America (Peru, Bolivia, Chile, and Argentina).

In the 1800s, the main center of production moved to North America, i.e., Mexico, Canada, and the United States (Nevada). Also, significant quantities of silver were produced in Russia and Australia, and the output from Europe increased, although by then this was almost entirely associated with lead and zinc ores.

After World War II, Poland became an important producer following the exploitation of newly discovered silver-containing copper deposits.

### 24.1.1 Production [1–13]

By the beginning of the Middle Ages (ca. 800 A.D.), a total of ca 75 000 t of silver is estimated to have been extracted. By then the silver deposits of the European Mediterranean region, almost the only regions to be mined in ancient times were effectively exhausted.

At the end of the Middle Ages, world production had almost dropped to 50 t/a. During the whole of the Middle Ages, ca. 250 000 t silver was extracted, most of which came from Europe, mainly the German-speaking area.

By 1975, average world primary silver production ca. > 10 000 t/a, and by 1991, it reached a peak of 11 500 t/a. The countries of North and South America today account for more than two-thirds of world production. In 1975, Poland was by far the largest producer in Europe. For primary production figures, see Table 24.1.

In total,  $(1-1.2) \times 10^6$  t silver has been extracted worldwide. This is about 10 times the figure for gold production and 100 times the total world production of platinum.

Table 24.1: Western world silver production (t/a).

Region	1989	1990	1991	1992
Mining production	11481	11833	11560	11480
Mexico	2306	2360	2250	2400
United States	2007	2080	1850	1820
Peru	1840	1725	1770	1500
Canada	1306	1535	1290	1150
Australia	1168	1321	1180	1080
Others	2854	2812	3220	3530
Secondary silver	3344	3700	3380	3450
Total	14825	15533	14940	14930

Very little has been written about the techniques of silver extraction in ancient times. The Egyptians are thought to have separated gold from silver by heating with salt. They must therefore have known how to convert the silver chloride produced into metallic silver.

The main source of silver in ancient times was silver-containing lead ores. In the Middle Ages, deposits of native silver were also important, especially in Central Europe. The rich ores could be smelted simply after hand separation (i.e., after crushing and separating from the worthless rock). Large pieces weighing more than 100 kg, or large blocks weighing many tons and containing native metal, were found and processed in this way.

The Greeks, the Romans, and the miners of the Middle Ages knew how to process silver-containing lead ores by smelting to produce lead. In the Middle Ages, the lead was removed by oxidation in cupellation furnaces to produce silver with a fineness of 650/1000–875/1000. This could then be oxidized further to give a fineness of 990/1000.

When the silver was accompanied by copper in the deposit, the liquation process [14] was used. The silver-containing copper was melted with lead, and the silver-rich liquid phase recovered by liquation was blown with air.

Introduction of the amalgamation process in 1566 improved silver productivity and production rates in Mexican and South American mines. This process later became dominant and was used in the United States and, from 1800, in Europe in a modified form suitable for a wide range of raw materials.

After the mid-1800s several new techniques were developed that replaced the old processes or improved economics. For example, the lead cupellation process was made more efficient by introduction of the Pattinson process (1833) which for a time was very widely used. This was based on the segregation of solid lead from the lead silver melt by cooling. This increased the silver content to 2.5% and thereby decreased the load on the cupellation process. The Parkes process (1850) soon replaced the Pattinson process be-

cause of its superior economics. In this process, silver was transferred from the lead to zinc floating on the surface of the lead; this formed a crust that could be removed. The Parkes process is still virtually the only process used today for extracting silver from lead ores. It is also used to extract silver from lead-zinc and zinc ores.

The chloridizing roasting of copper ores followed by leaching with brine to dissolve the silver chloride formed was introduced in 1843 by Augustin; it was soon replaced by sulfation roasting, at temperatures below the decomposition temperature of silver sulfate and above that of copper sulfate, followed by leaching with water. This was known as the Ziervogel process, and for almost 100 years most of the silver in German ores was extracted in this way. The sulfuric acid extraction of dead-burnt copper ore in a stream of air, to form a silver-containing slime, was used for only a short period. After 1856, thiosulfate leaching of chloridized roasted ore was used primarily in Mexico and California. In the Paterson process, sodium thiosulfate was used; in the Kiss process, calcium thiosulfate; and in the Russel process, sodium copper thiosulfate. Since ca. 1900, cyanide leaching, which is still used for silver ores that are not smelted, has been the most important aqueous treatment process.

Since ca. 1876, almost all the silver associated with copper has been obtained from the electrolytic refining of copper. The silver appears in the copper anode slimes, which are generally treated by pyrometallurgical processes.

To separate silver from the gold in auriferous silver (the end product of nearly all smelting and hydrometallurgical extraction processes), the nitric acid process (developed in 1433) and the sulfuric acid process (dating from 1802) have been completely replaced by electrolytic refining.

### 24.1.2 Monetary Significance and Price Structure [1, 15, 16]

From ancient times to the Middle Ages and later, even into the present century, silver was the classic metal for currency. In comparison, gold played an almost insignificant role.

In the 6th century B.C., King Cræsus ordered the minting of silver coins. In ancient Greece, silver currency was the basis of the economic system. In 296 B.C. the Romans introduced the silver denarius as the general method of payment, and gold ceased being used in coins from 217 B.C. Silver was the basis of the coinage reform by the Byzantine Empire in A.D. 310, and was recognized throughout the Mediterranean region, so that silver maintained its importance as a coinage metal for many centuries. Charlemagne made silver the basis of the currency system of his empire.

During the last two centuries, gold began to displace silver, mainly due to the reduction in the price of silver caused by the surplus from new production, as well as the demonetization of silver.

Between the two world wars, strong moves, triggered by inflation and the world economic crisis, were made to remonetize silver, but these largely came to naught.

After World War II, because of the increasing demand and the shortage of supply, the price of silver rose so much that by 1970 the value of the silver in the most important silver coins still in circulation (U.S. dollars and Swiss francs) exceeded the face value of the coins. Silver was therefore virtually completely demonetized.

After the 17th century, the ratio of the prices of silver and gold remained fairly constant at ca. 1:15 for a long period. However, free price movements have continually tended to shift this ratio, and it has often been kept constant by state intervention. A fairly gradual increase in the price of gold began ca. 120 years ago. At the beginning of World War I, the ratio reached 1:40. During the World War II it rose to 1:100, and during the following

three decades it fluctuated around 1:40. In 1981 it was 1:50, and in 1992 it was 1:95.

Silver prices have been freely determined by supply and demand from 1970, after which the price rose steadily from ca. 180 DM/kg to 300–500 DM/kg. In late 1979 and early 1980, speculative dealings of a hitherto unimagined volume occurred, and the price of silver briefly reached nearly 2750 DM/kg [17]. In the following decade, and up to the present, a rapid and fairly continuous decline in price has taken place, reaching a low of 15 DM/kg in 1992. The price of silver now reflects its status as an industrial metal and depends on the current economic situation. In parallel with this, silver has lost its importance as an investment metal. The high stock levels and sales of these stocks from time to time also affect price reductions.

## 24.2 Properties [18–23]

Silver, like gold and the platinum-group metals, is a noble metal. Silver, gold, and copper are known as the coinage metals.

### 24.2.1 Atomic Properties [24]

Silver has an atomic number of 47 and a relative atomic mass of 107.8682. Natural silver consists of the stable isotopes  $^{107}\text{Ag}$  (51.8%) and  $^{109}\text{Ag}$  (48.2%). Many artificial isotopes with relative atomic masses between 102 and 117 are known.

The electronic configuration of silver is  $[\text{Kr}] 4d^{10}5s^1$ . The  $5s^1$  shell is the principal valence orbital, which accounts for the preference for oxidation state 1. The  $4d$  shell can also act as a valence orbital, resulting in oxidation states 2 and 3. Thus, silver behaves as a transition metal due to the contribution from the inner valence orbital. Since the differences between the energies of the valence electrons are small, silver has a tendency to form complexes with covalent bonds and to exhibit other properties such as catalytic activity typical of transition metals.

The atomic radius of silver (with 12-fold metallic coordination) is 0.144 nm; the ionic

radius of  $\text{Ag}^+$  (six-coordinate) is 0.137 nm, and of  $\text{Ag}^{3+}$  (six-coordinate) 0.075 nm.

### 24.2.2 Physical Properties

The physical properties of silver are generally intermediate between those of copper and gold. These three elements have strong similarities, although silver has some anomalous properties, which are directly related to the  $d^{10}s^1$  electronic configuration and the irregularity of the atomic radii. Some physical data are given below:

Lattice constant at 20 °C	0.40774 nm
Atomic radius (in metal)	0.144 nm
Melting point	961.9 °C
Boiling point	2210 °C
Specific heat capacity at 25 °C	0.23 J kg <sup>-1</sup> K <sup>-1</sup>
Thermal conductivity	418 W m <sup>-1</sup> K <sup>-1</sup>
Vapor pressure at 1030 °C	1.33 Pa
1190 °C	13.3
1360 °C	133
1580 °C	1330
1870 °C	13 300
Density at 20 °C	10.49 g/cm <sup>3</sup>
Density of liquid at <i>mp</i>	9.30 g/cm <sup>3</sup>
Density of liquid at 1250 °C	9.05 g/cm <sup>3</sup>
Brinell hardness	26
Modulus of elasticity	82 000 MPa
Tensile strength	140 MPa
Resistivity at 0 °C	1.50 Ωcm

Like copper and gold, silver crystallizes in a face-centered cubic structure in which each metal atom is surrounded by 12 neighbors. This high degree of symmetry results in a structure with many slip planes and is the reason for its good mechanical formability. Silver is only slightly less ductile than gold. It can be given a high polish and has a warm, white luster. Very thin films are blue or green by transmitted light, thicker films being yellow to brown.

Silver has the highest electrical conductivity, the highest thermal conductivity, and the lowest electrical contact resistance of all metals.

### 24.2.3 Chemical Properties

Molten silver absorbs oxygen and releases it during solidification, with bubbling of the metal surface. At 1000 °C, 1 cm<sup>3</sup> of molten silver dissolves a maximum of ca. 20 cm<sup>3</sup> of oxygen, corresponding to a stoichiometric



composition of  $\text{AgO}_{0.01}$ . The solubility of oxygen in silver just below its melting point is only ca. 1/40 of that at 1000 °C. Hydrogen is very slightly soluble in molten silver, whereas nitrogen, carbon monoxide, carbon dioxide, and the noble gases are insoluble.

Halogens react violently with silver at red heat. Moist chlorine gas corrodes silver even at low temperature. Ozone blackens the surface of silver due to oxide formation.

Hydrogen sulfide (gaseous or in solution) and aqueous solutions of sulfides immediately form a black coating of silver sulfide on the surface of the metal. At high temperature, the reaction with hydrogen sulfide gas or sodium polysulfide solution can lead to complete conversion of silver to silver sulfide.

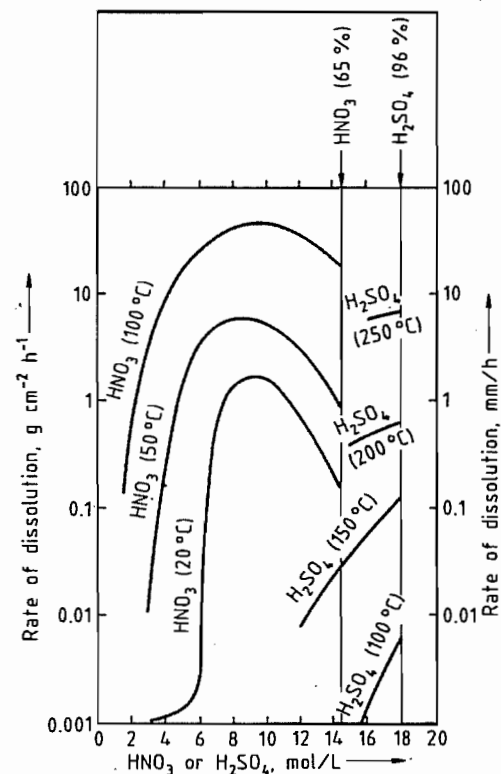
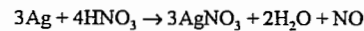

Figure 24.1: Rate of dissolution of silver in nitric acid and sulfuric acid as a function of concentration and temperature.

The solubility of metallic silver in water is very low, but it is sufficient to exhibit an oligo-

dynamic (bactericidal) effect (see Section 24.12.2).

The preferred medium for dissolution of silver is hot, concentrated nitric acid (Figure 24.1):



Silver also dissolves rapidly in hot concentrated sulfuric acid (Figure 24.1):

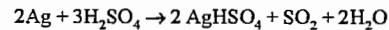

Rates of dissolution in dilute sulfuric acid are appreciable if oxygen or hydrogen peroxide are present. The initially vigorous reaction with aqua regia

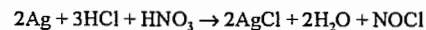

is rapidly slowed by the formation of a coating of silver chloride. Most common oxidizing aqueous media attack silver, including chromic acid, permanganate solutions, persulfuric acid, selenic acid, and aqueous solutions of free halogens. The following also attack silver: hydrochloric acid, phosphoric acid, bromine water, solutions of alkali-metal chlorides, copper chloride, and iron chloride. The reactions are often strongly dependent on temperature and in some cases on the formation of protective coatings. Silver is resistant to aqueous solutions of organic acids and aqueous alkali.

Silver is fairly resistant toward fused sodium hydroxide at ca. 550 °C in the absence of atmospheric oxygen and moisture. Potassium hydroxide is more aggressive. Silver is attacked by fused salts such as sodium peroxide, potassium nitrate, sodium carbonate, potassium hydrogensulfate, and potassium cyanide.

## 24.3 Occurrence and Raw Materials [1–3, 25–27]

### 24.3.1 Formation, Abundance, and Distribution of Ores

Because of its chalcophilic character, silver became concentrated in oxidic sulfidic materials during the formation of the Earth's mantle, which has a silver content of ca. 10 ppm. The

metallic core of the Earth should have a much lower silver content because silver does not alloy with iron or nickel. This is confirmed by investigation of iron meteorites. In the region accessible to mining (i.e., to a depth of 5 km), the Earth's crust has an average silver content of 0.05–0.1 ppm. Thus, silver is 100 to 1000 times more abundant than gold or platinum. The average silver content of the oceans is ca. 0.001 ppm [28], but it often reaches much higher values at the mouths of rivers. This enormous reserve of silver ( $10^9$  t) cannot, however, be extracted economically.

Silver became concentrated at particular sites in the Earth's crust by the recrystallization of silicate magmas caused by volcanic action in impregnation zones. Most sulfidic, arsenic, and antimonidic formations were originated in this way. Hydrothermal processes caused conversion to metallic deposits. Also, the action of the atmosphere and hydrosphere was involved (e.g., in the formation of caps over magmatic deposits). Unlike gold and the platinum metals, silver has not formed sedimentary deposits to any extent, since it is dissolved much more readily than gold or platinum by the action of the hydrosphere. However, silver-containing sedimentary deposits of other elements are known (e.g., Mansfeld copper slate).

### 24.3.2 Silver Minerals [3]

Nearly all silver minerals are compounds of silver with sulfur, its homologues selenium and tellurium, and their neighbors in the periodic table, arsenic, antimony, and bismuth. These ores generally have a metallic luster and are semiconductors. Other silver minerals include the halides and the free metal. The major mineralogical groups—oxides, silicates, spinels, phosphates, gypsum, and carbonates—are not represented.

*Native silver* occurs in the form of nuggets, dendrites, sand-like material, or sometimes as large lumps or blocks. It often forms mixed crystals with gold, and can also contain copper and other metals and metalloids.

*Argentite*,  $\text{Ag}_2\text{S}$ , is the most common silver compound found in the sulfidic ores of other metals, especially galena,  $\text{PbS}$ , in which it is present with other sulfidic minerals in the form of very fine inclusions. In the Middle Ages, argentite was often found in high concentrations and was a mineral in its own right with a high silver content.

Pyrrargyrite, antimony silver blende,  $\text{Ag}_3\text{SbS}_3$ , is an important mineral occurring in true silver ores, which are now found and mined mainly in Central America.

Proustite, arsenic silver ore,  $\text{Ag}_3\text{AsS}_3$ , is of similar occurrence to the corresponding antimony-containing sulfur compound  $\text{Ag}_3\text{SbS}_3$ .

Stephanite,  $\text{Ag}_5\text{SbS}_4$ , is very characteristic of the silver ores familiar to miners from early times.

*Cerargyrite*, horn silver,  $\text{AgCl}$ , does not occur in large quantities. It has extremely low hardness and crystallizes with the  $\text{NaCl}$  lattice type.

Apart from the compounds mentioned above, many other well-defined silver minerals exist. Some of them, particularly the sulfur compounds, still make a significant contribution to silver production.

Some examples are given below:

Miargyrite	$\text{AgSbS}_2$
Polybasite (Eugenite)	$\text{Ag}_2\text{SbS}_6$
Freibergite	$(\text{Cu,Ag})_{12}\text{Sb}_4\text{S}_{13}$
Freieslebenite	$\text{Ag}_3\text{Pb}_2\text{Sb}_3\text{S}_8$
Andorite	$\text{AgPbSb}_3\text{S}_6$
Stromeyerite	$\text{Ag}_2\text{Cu}_2\text{S}_2$
Schapbachite	$\text{AgBiS}_2$
Argyrodite	$\text{Ag}_8\text{GeS}_6$
Sternbergite	$\text{AgFe}_2\text{S}_3$
Argentopyrite	$\text{AgFe}_3\text{S}_5$
Argyropyrite	$\text{Ag}_2\text{Fe}_7\text{S}_{11}$
Sundite	$\text{AgFeSbS}_9$
Hessite	$\text{Ag}_2\text{Te}$
Petzite	$\text{Ag}_3\text{AuTe}_2$
Silvanite	$\text{AgAuTe}_4$
Bromyrite (Bromargyrite)	$\text{AgBr}$
Embolite	$\text{Ag}(\text{Cl,Br})$
Iodite (Iodargyrite)	$\text{AgI}$

Silver is a component of most sulfidic minerals, at least at the parts-per-million level. The silver compounds are present as mixed crystals or as microscopic inclusions with a crystal structure that deviates from that of the matrix.

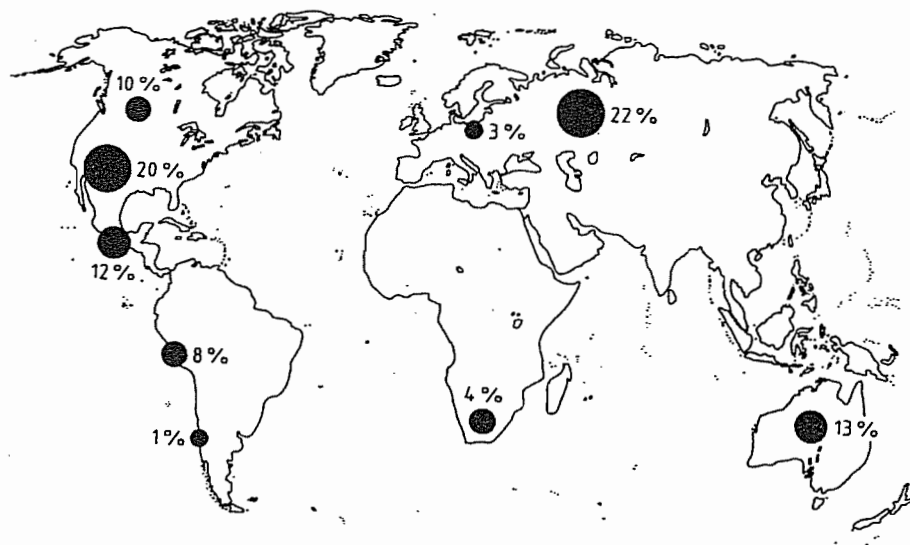

Figure 24.2: Reserves of silver by region.

### 24.3.3 Deposits [3, 29–34]

The known silver deposits are associated mainly with vulcanism in the Tertiary period running, for example, in a continuous line along the entire west coast of the American continent (Figure 24.2).

True silver ores, in which silver is practically the only valuable metal, are mined mainly in Mexico (Pachuca, Frenillo, and San Fernando de l'Oro) and to a small extent in the United States (Utah). In Europe, such deposits are almost completely exhausted. Worldwide, they still account for more than one-tenth of the silver mined. Depending on the price of silver, it can be economic to process materials containing 0.01% (100 ppm) silver, or even less. The deposits in Ontario, which contain native silver associated with cobalt sulfide and arsenide, can also be regarded as true silver ores, since only the silver is extracted.

Argentiferous lead and lead–zinc ores, which often occur in association, are distributed widely. In almost all silver-producing countries, they constitute an important fraction of the silver produced by mining and account for ca. 50% of world silver production. The separation and recovery of silver during

lead production is profitable even for a silver content of a few parts per million. The important reserves in Europe include those in Spain (Lineares, Sierra Morena), Germany (Rammelsberg/Harz), former Yugoslavia (Trepca), and to a lesser extent Italy (Montevecchio, Monteponi), Greece (Laurion), and France (Savoy). Argentiferous lead and lead–zinc ores are mined in large quantities in the United States (Helena, Montana; Denver, Colorado; Cœur d'Alene, Idaho), Mexico, Peru, Bolivia, and Argentina. In Australia and Tasmania, lead and lead–zinc ores are the primary source of silver. In North Africa (Djebel Hallouf, Tunisia; BeniSat, Algeria), Nigeria, and Namibia (Otavi), these are of some importance. In South Africa, other silver ores are more important. In India, the extraction of silver from lead and lead–zinc ores is extremely important, and this appears to also be true of the Commonwealth of Independent States (CIS).

Argentiferous copper ores, which sometimes also contain nickel and cobalt, satisfy ca. 30% of the world silver demand. Even very low contents of silver can be recovered profitably from copper ores, since almost all the copper is electrorefined, and the silver remains in the anode slimes. In Europe, the larg-

est reserves of argentiferous copper ore are in Poland (Katowice), Yugoslavia (Bor), and Sweden. Smaller reserves can be found in Finland. The CIS, from which little information is available, is also believed to have reserves of this type. The largest argentiferous copper reserves in the world are in Canada (Sudbury, Ontario, Rouyn–Noranda, Québec). Silver is also recovered during copper smelting in Chile, Bolivia, Peru, Katanga, Namibia, Zimbabwe, and South Africa.

Extraction of silver from gold ores is carried out mainly in South Africa, and also in Canada, Alaska, and Sweden (Boliden). The quantity obtained in this way is < 10% of world silver production. Silver-containing tin deposits are concentrated in Bolivia (Cerro de Pasco, Potosi) but also occur in Burma and Argentina. Silver produced from tin ores amounts to only 2% of world production.

### 24.3.4 Secondary Silver [35–40]

The demand for silver that cannot be met by mining must be made up by recycling and by release from stocks. However, stocks of silver are often in a condition (e.g., type of alloy or low purity) that is not accepted directly by the market. Hence, these materials must generally be refined.

Silver coins have been almost entirely withdrawn from circulation. Some were refined immediately, but a smaller number were saved. From time to time, large stocks of these coins are released unpredictably, usually in association with speculative dealings on the silver market.

Even when the coins are of uniform composition, the alloy generally cannot be reused directly because, for example, the quantity is too large or the alloy is too complex. The silver content of coinage alloys is 40–90%. Copper is the other main alloy component, and nickel, zinc, or traces of other metals are generally present.

The old Indian silver reserves come onto the market in the form of fittings and similar articles; the silver content is 90–95%.

Photographic slimes, produced during the manufacture of films and photographic paper, have a silver content of 5–30%. The silver is present as a halide, the remainder being mainly gelatin and water.

Approximately 50% of the silver used in the photographic industry ends up in fixing baths. The silver-containing fixing bath solutions are rarely supplied directly to refineries. Instead, silver is usually extracted from them where they were produced, either by electrolysis to yield compact crude silver of fairly high purity or by chemical reduction to give slime concentrates (10–60% Ag).

The archives of X-ray films and motion pictures, which are stored for a limited period only, are a continuing source of recycled silver. In developed X-ray film the silver content is 1–2%; in developed black-and-white film it is 0.2%, but in developed color film the amount is negligible. The films are converted to ashes or slimes with silver contents up to 90%.

Offcuts of X-ray and graphic film from the photographic industry and film material stored too long (e.g., from military stocks) have a silver content up to 3%.

Photographic printing paper offcuts from the photographic industry have a silver content of ca. 0.4%. These papers used to contain up to 50% barium sulfate filler, but modern papers are mainly polymer coated and have a low filler content.

Scrap silver from tableware and ornaments usually with silver content of 80 or 92.5%, is important during periods of high silver prices. The treatment of silver-plated utensils (e.g., cutlery with ca. 4–5% Ag) is usually profitable only in large quantities.

The electrical industry and its suppliers generate waste materials during the manufacture of electrical contacts at various stages of the production processes. Waste also arises from the production of small batteries for domestic electronic use and larger units for the military and air transport areas [41]. These cells often contain mercury. Silver-plated switching elements are produced in the electronics industry.

The chemical industry provides spent silver-containing catalysts [36]. These include silver wire mesh or silver crystals used in the oxidation of methanol to formaldehyde and Ag- $\alpha$ -Al<sub>2</sub>O<sub>3</sub> catalysts for the oxidation of ethylene to ethylene oxide.

A regular, though small, quantity of silver comes from equipment and silver-plated vessels or pipework used in the chemical industry. Finally, the amount of silver waste from the production of dental amalgams is not inconsiderable. It consists of granules of Ag-Sn-Hg alloys and is usually contaminated with other materials, including organic substances.

### 24.3.5 Resources and Reserves

[15, 23, 25, 34]

Mineral "resources" include all the principal known deposits, including those that have not yet been proved, but are only assumed. They also include deposits that are known for certain to exist, but cannot be extracted for economic or ecological reasons [42].

Mineral "reserves" include only those deposits that are already economically exploitable, or whose existence, based on prospecting work, is certain or probable [42]. These mineral reserves amount to ca. 250 000 t of silver at the present time. With a demand of ca. 10 000 t/a, silver is one of those metals whose known raw material reserves can supply the demand only for a limited period. By far the largest proportion of the silver is contained in lead, zinc, and copper ores, so silver production is linked primarily to the demand for these metals. This is probably not a good situation from viewpoint of future supplies. However, the advantage is that silver reserves are much more widely distributed than those of gold and the platinum metals, so the supply of silver to industrialized nations would be much less threatened by possible political crises than the supplies of other important raw materials.

## 24.4 Extraction from Ores

[1, 3, 12, 19, 42-44]

### 24.4.1 Extraction from Silver Ores

#### 24.4.1.1 Smelting

In the early days, considerable quantities of silver were extracted simply by smelting high-percentage silver ores under oxidizing or reducing conditions with conversion of accompanying materials into slag. The starting materials were almost exclusively ores containing elemental silver, silver sulfide, or silver halides.

#### 24.4.1.2 Amalgamation

For many centuries, amalgamation was the most important process for the treatment of true silver ores. Today, it is rarely used because of high costs, poor yields, and the toxicity of mercury. It is now carried on in privately owned small mines. The amalgamation process can be used directly only if the silver is native or is present as the chloride. In this form it will amalgamate on contact with mercury without any other treatment.

Amalgam formation does not take place as rapidly as with gold, but the reaction velocity and rate of dissolution of silver in mercury are nevertheless fairly high. The copper-plate amalgamation process used with gold cannot be used with silver because reaction times are too short to give a useful yield. To ensure problem-free amalgam formation, the silver or silver halide particles should first be liberated, preferably by wet grinding. However, an extremely fine particle size is detrimental to the process.

Sulfidic, arsenidic, and antimonidic silver minerals do not react directly to form an amalgam and therefore require pretreatment. This can consist of a simple oxidative roasting process or roasting accompanied by chloridization or sulfation.

The reaction is accelerated and the yield improved by the addition of base metals (e.g.,

iron and copper), sodium chloride, copper(I) or copper(II) chloride, or copper sulfate. The following are some of the reactions that occur:

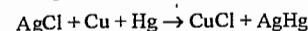
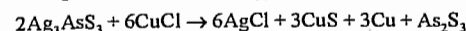
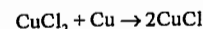
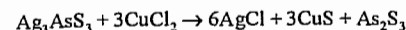
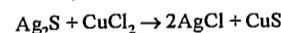
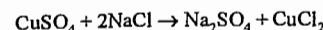

The operating techniques and the choice of reaction conditions have undergone many changes. In the Patio process, a paste of finely ground ore, sodium chloride, mercury, and water was kneaded. Other processes employ copper or iron pans, stirring apparatus, or rotating vessels, either with or without heating. The resulting metallic phase is washed to remove accompanying materials, and the residual liquid mercury is separated from the solid amalgam. The latter is heated in retorts to distill off the mercury and yield impure silver. The overall yields of silver obtained in the amalgamation process reach 95% under favorable circumstances. The loss of mercury amounts to 0.2-2 kg for each kilogram of silver.

#### 24.4.1.3 Cyanidation

Because of its favorable economics, the aqueous cyanide process is the dominant process for extraction of silver from true silver ores. The conditions are essentially the same as those for the gold cyanide process.

The ore is crushed, wet milled, and treated with an aqueous solution of sodium cyanide (5-10 g/L) for several days in a Pachuca tank [3]. Solids are removed by a thickener and filter, and silver is precipitated from solution by cementation on zinc dust. Other possible methods of recovering silver are ion exchange or electrolytic reduction [4]. Another process involves adsorption of the silver cyanide complex onto active carbon [45, 46], analogous to the carbon-in-pulp process for gold. This process has been fully developed, but has not achieved the same importance or productivity as in the case of gold.

Silver chloride, either naturally occurring or produced by a chloridizing roast, is dissolved according to the equation

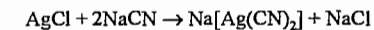

Elemental silver is dissolved by passing air into the solution:

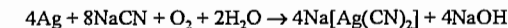

Silver sulfide is also attacked, but more slowly, according to the following equations:

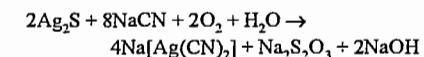

and

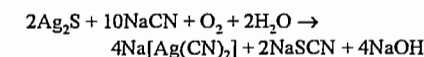

If the ores contain cyanide-insoluble silver compounds such as proustite (Ag<sub>3</sub>AsS<sub>3</sub>) and pyrargite (Ag<sub>3</sub>SbS<sub>3</sub>), cyanide extraction must be preceded by chloridization roasting. The dissolution of selenidic and telluridic compounds of silver by cyanide is also difficult, but is improved by fine grinding and roasting, as well as by the use of cyanogen bromide, which also increases the solvent action of the sodium cyanide on metallic silver:

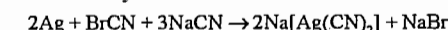

Coarse metallic silver particles and manganese-containing silver ores can also lead to complications.

In general, the leaching of silver ores proceeds more slowly than with gold ores. Also, the yield with gold is higher than that with silver. If only metallic silver and silver chloride are present the yield can reach 98%, but with other ores it is sometimes only 80%. The final silver content of the powdered ore after the extraction of silver can be as low as 0.5 ppm in favorable cases.

#### 24.4.1.4 Thiosulfate Leaching (Patera Process)

The process of leaching silver ores with thiosulfate solution was developed originally in Europe under the name of the Patera process. In the 1800s its importance increased in Central and South America, and later in North America as well. It replaced the amalgamation

process, mainly because of its higher yield and lower cost. However, in a few decades it was replaced by the more economical cyanide leaching process and is now seldom used. Halide-containing silver ores or chloridized roasted ores undergo the same reactions that form the basis of the photographic fixing:

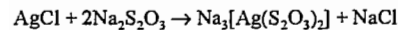

and

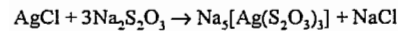

An excess of sodium thiosulfate should be present to prevent formation of the sparingly soluble complex  $\text{Na}[\text{Ag}(\text{S}_2\text{O}_3)]$ . The sodium thiosulfate concentration is usually 2.5–25 g/L. In variations of the process, sodium copper thiosulfate or calcium thiosulfate is used. Silver is precipitated from solutions by the addition of sodium sulfide. Yields of silver in the thiosulfate process are lower than in the cyanide process. Processing techniques are similar. A disadvantage of the thiosulfate process is that gold is insoluble and therefore not recovered.

#### 24.4.1.5 Metallurgical Processes

True silver ores are often added directly to copper or lead smelting operations. This is especially true if the accompanying gangue minerals are of use in the smelting process (e.g., quartz, which benefits the copper shaft furnace process).

### 24.4.2 Extraction from Lead and Lead-Zinc Ores [32]

#### 24.4.2.1 Production of Lead Bullion

In all process stages in the extraction of lead from lead and lead zinc ores, silver follows lead. This applies to ore flotation; ore sintering; reductive smelting in the blast furnace; removal of copper by sulfur; and removal of arsenic, antimony, and tin by selective oxidation (see Chapter 9).

The next stage is the extraction of silver and other noble metals. Historically, several

processes have been used in succession, each one replacing its predecessor, namely, cupellation (oxidation), cupellation after the silver has been concentrated by the Pattinson process, and concentration by the Parkes process followed by zinc removal and cupellation.

#### 24.4.2.2 Cupellation without Prior Silver Enrichment

Before processes for concentrating the silver in lead bullion were developed (i.e., up to the 1800s), all the lead had to be converted to litharge (PbO) by oxidation (cupellation), and then the litharge removed from the silver-enriched metallic phase. This yielded an impure product that was converted to contemporary commercial-grade silver by a refining operation, which consisted essentially of further oxidation in a small furnace. Here, the elements copper, selenium, and tellurium were removed by repeated addition of pure lead, and subsequent addition of silver sulfate removed bismuth and lead. Oxidizing agents such as sodium nitrate and sodium carbonate were also added, and removal of the last traces of litharge formed was assisted by the addition of fluxes (e.g., glass).

#### 24.4.2.3 Silver Enrichment by the Pattinson Process

A significant technical advance in the process of silver concentration was achieved by PATTINSON (1833). After this discovery, silver-containing lead no longer had to be treated by the costly cupellation process because the crude lead could be separated into two fractions, one with a low silver content and the other containing 2% Ag. The process was based on the fact that when molten silver-containing lead is cooled (e.g., 0.2% silver), pure lead separates until the silver content in the liquid phase reaches 2.5%. However, because of the difficulty of separating lead crystals from the silver-containing molten metal, complete separation cannot be achieved in a single operation. If the process is repeated, a grade of lead with a low silver and bismuth content (<

10 ppm silver), and a grade of lead with a high silver content ( $\leq 2\%$  silver) that is suitable for cupellation, can be produced, at an acceptable cost.

The fraction that contains silver and bismuth also contains gold. The theoretical silver content of 2.5% is not achieved in practice, since the small temperature difference between the melting point of pure lead (327 °C) and that of the eutectic mixture (304 °C) means that separation becomes more difficult as the eutectic point is approached. The presence of copper, nickel, arsenic, antimony, and bismuth can also interfere with the removal of silver. Larger amounts of these elements therefore have to be removed first. Some copper goes into the Pb-Ag alloy, and some into the lead crystals, so that purified lead from the Pattinson process always contains some copper. Arsenic is found mainly in the lead crystals, whereas nickel and antimony follow bismuth into the silver-containing melt. In the usual operating procedure, either the lead crystals were removed by hand sieving, or the silver-containing melt was siphoned or tapped off. The fractions obtained were then treated again by crystallization. A series of cast iron vessels of 10–15 t capacity was employed, using countercurrent flow from the center to both sides. About 15 units were needed. Two-thirds of the contents of the vessel were recovered as crystals, and one-third remained as melt.

#### 24.4.2.4 Silver Enrichment by the Parkes Process

Today, the silver in bullion lead, together with gold and platinum metals, is concentrated by the Parkes process. The process involves the production of a solid alloy of lead, zinc, and silver by stirring zinc into molten impure lead. This so-called zinc crust floats on the surface of the molten metal (450 °C). It is skimmed off; the adhering liquid lead is removed by hot pressing, and the zinc is distilled in a retort or vacuum furnace. The residue consists of a lead noble-metal alloy with up to 50% silver, ca. 1% zinc, and some copper, ar-

senic, antimony, and bismuth. It is oxidized by cupellation to obtain crude silver or, if appreciable amounts of gold are present, auriferous silver.

#### 24.4.2.5 Cupellation of Enriched Lead

The cupellation process removes lead and small amounts of other base elements from the silver and accompanying noble metals by selective oxidation.

In the cupellation process, the lead melt is blown with air to produce molten lead oxide (litharge, PbO), while the silver, gold, and platinum-group metals do not react. The liquid layer of lead oxide produced covers the molten metal completely, but the oxidation reaction is not seriously impeded since the hot litharge takes up oxygen and then releases it to the molten metal. Copper, which is usually present, also assists the transport of oxygen. During cupellation, the temperature must be sufficiently high for the litharge (*mp* 886 °C) to form a low-viscosity melt that does not incorporate metallic and noble-metal components. At the end of the process, when the melt has a higher silver content and therefore a higher melting point, the operating temperature must be significantly greater than the melting point of silver (963 °C). In practice, the process is operated at 900–1100 °C. If the temperature is too high, volatilization can occur, which leads to losses of silver. The molten litharge formed must be removed continuously to prevent the layer from becoming too thick. The end of the smelting process is recognized when the litharge layer becomes thin and finally breaks up. The bright surface of the silver can then be seen. The last traces of litharge are mixed with marl (calcium carbonate) to facilitate its complete removal. Molten silver is usually cast into anodes for electrorefining. The copper and lead contents of the crude silver should preferably not exceed 1.0 and 0.1%, respectively. Of the normal impurities, zinc, arsenic, antimony, and copper go mainly into the litharge that is first produced, although some go into the slag that can be re-

moved after the initial melting operation. Bismuth becomes concentrated in the end fraction of the litharge.

The so-called English cupellation furnace (cupel) is now nearly always used for the cupellation process in lead smelting plants. The hearth, which is replaceable, is lined with magnesite bricks, and can be tilted to pour off the litharge and molten silver. It is fired under a flat hood. Air is blown through nozzles over the surface of the melt, freeing part of the metal surface of molten litharge. The litharge layer is removed when it reaches a thickness of ca. 1 cm. About 100 kg of lead is oxidized per hour per square meter of furnace area; the capacity is ca. 1000–2000 kg silver. The so-called German cupel is larger and has a fixed hearth with a launder at the front that can be lowered continuously, so that as the volume of molten metal decreases, the litharge is continually removed. Molten silver must be skimmed off. The greatest advantage of the smaller English smelting furnace is that less silver is required for its operation. The lining of the hearth of the cupel picks up a certain amount of silver, so that after dismantling, the broken lining with litharge attached must be treated in a lead shaft furnace.

#### 24.4.2.6 Silver Extraction from Electrolytic Lead Refining

The aqueous electrorefining of lead bullion usually produces anode slimes that are difficult to process, whose composition is similar to that of the anode slimes from the electrorefining of copper [Cox] (Table 24.3). They contain all the noble metals and other impurities associated with crude lead. They are treated by pyrometallurgical processes to obtain auriferous silver and other valuable metals. Copper anode slimes and lead anode slimes are sometimes mixed and treated together.

### 24.4.3 Extraction from Copper and Copper–Nickel Ores [31, 45–51]

#### 24.4.3.1 Formation of Silver-Containing Copper Anode Slimes

In silver-bearing ores of copper, copper–nickel, and copper–nickel–cobalt, the silver stays with the copper-rich fractions during all concentration stages, including mechanical processing and smelting (see Chapters 8 and 12). It is transferred from the copper matte into the crude copper. Gold also follows the copper and silver, but only a small fraction of the platinum metals go to the crude copper, the majority accompanying the nickel. Today, all crude copper is electrorefined. The copper anode slimes formed contain almost all the silver and noble metals, and large amounts of copper, lead, nickel, selenium, tellurium, arsenic, antimony, and sulfur. Because of their composition, the economic and ecologically acceptable treatment of copper anode slimes is one of the most difficult tasks in the metallurgy of noble metals. Before the introduction of electrorefining, silver had to be extracted from copper matte produced by the copper shaft furnace.

#### 24.4.3.2 Pretreatment of Copper Anode Slimes

Coarse copper particles that become detached from the anodes or appear as growths on the cathodes are removed first by sieving which eliminates ca. 30% of the weight of the slime. In the following pretreatment process, elemental copper (formed by disproportionation of  $\text{Cu}^+$  in the electrolyte), copper telluride, and copper selenide are dissolved by treatment with 4–5 mol/L sulfuric acid, with addition of air or oxygen at 60–95 °C. The effectiveness of this technique is limited, especially if the selenium content is high.

Table 24.2: Typical compositions (%) of untreated and pretreated copper anode slimes and untreated lead anode slime.

Source	Ag	Au	Se	Te	As	Sb	Bi	Cu	Pb	Fe	Ni	SiO <sub>2</sub>	Al <sub>2</sub> O <sub>3</sub>	S
<b>Untreated copper anode slime</b>														
Asarko, USA	18	1	9	1	4	4		21	10					5
Boliden, Sweden	11	2	21	1	1	1	1	40	10		1			3
Nordd. Affinerie, Hamburg	10	0.3	5					17	15					
Outokumpu, Finland	10	0.5	4		0.7	0.1		11	3	0.6	45	2		2
Mt. Lyell, Australia	1	0.2	3		0.7	0.1	0.01	67	1		0.1	1		10
El. Ref. Smelt. Co., Australia	8	2	3	3	4	8	0.1	14	24	0.4	0.5	10		8
Can. Copper Ref., Montréal	19	1	20	3	0.6	0.5		37		0.6	0.2			
Noranda, Québec	13	2	28	4	0.3	0.3		46		0.4	0.2			
Rio Tinto, Spain	8	0.7	8	0.5	2	3	0.5	25	10	0.3	0.1	20		
Pelabora, South Africa	15	0.6	5	0.5				15	5		4	30	10	
Cerro, Oroya, Peru	28	0.1	2	2	2	11	1	2	24					
<b>Pretreated copper anode slime</b>														
Impex	49	4	3	6				3	1		0.1	12	20	
Codelco, Chile	24	1	16	0.3	0.3	5		2	1					
Nordd. Affinerie, Hamburg	13	0.3	5	1	3	8	0.6	3	15	0.2	3	7		6
Outokumpu, Finland	37	2	13		0.3	0.2		0.5	12	0.3	1	13		
El. Ref. Smelt. Co., Australia	12	3	0.7	4	1	10	0.1	2	28		0.4			5
Can. Copper Ref., Montréal	41	4	7	3				4						
Boliden, Sweden	29	5	20			4	2	2	30		0.7	2		
Enami, Chile	50	0.9	6	2	1	10	0.4	0.4	7				6	
<b>Untreated lead anode slime</b>														
Cerro, Oroya, Peru	10	0.01	0.1	0.7	5	33	21	2	16					

Examples of the composition of untreated and pretreated copper anode slimes are given in Table 24.2. The wide variation in the compositions of the slimes both before and after treatment results in many process steps being carried out under very specific conditions that the processing industries often do not disclose.

#### 24.4.3.3 Processing of Copper Anode Slimes [52, 53]

**Processing of Copper Anode Slimes by Roasting.** *Oxidizing Roasting at 300–400 °C.* Roasting is performed on a thin layer of material or in an air-blown rotary furnace. Metallic copper is oxidized fairly easily. The selenides and tellurides of copper and silver are converted to selenites and tellurites. Only a small fraction of selenium dioxide is volatilized. The product is treated with dilute sodium hydroxide solution, which dissolves mainly the selenium. Treatment with dilute sulfuric acid dissolves tellurium preferentially, and some silver as well. Most of the selenium and tellurium (75–90%) can be brought into solution.

*Oxidizing Roasting at 600–800 °C.* The material is mixed with bentonite as a binder

and with copper(II) oxide and iron(III) oxide as reaction accelerators, pelletized, and reacted with air blowing. Up to 98% of the selenium can be recovered as  $\text{SeO}_2$  sublimate. The product is then leached with dilute sulfuric acid, which dissolves copper, tellurium, and some silver.

*Roasting with Sodium Carbonate.* A mixture of anode slime with sodium carbonate (sometimes with the addition of sodium hydroxide or sodium nitrate) is generally pelletized and heated at ca. 400 °C in air, so that selenium and tellurium are converted into water-soluble compounds. Copper, which is also oxidized, and most of the tellurium can be dissolved with dilute sulfuric acid. The resulting solution also contains some silver in the form of its sulfate.

**Processing of Copper Anode Slimes by Sulfation.** Dried anode slime is mixed with concentrated sulfuric acid and heated, first to 300 °C, and then to 400–500 °C, causing sulfation and oxidation. Most of the selenium sublimes as selenium dioxide. Most of the copper, silver, and nickel can be dissolved

with hot water, whereas the tellurium oxide formed remains undissolved in the residue.

**Hydrometallurgical Treatment of Copper Anode Slimes** [54]. Copper anode slimes can be dissolved in oxidizing acids. Treatment with  $\text{HCl}-\text{Cl}_2$  [55] gives a residue that contains silver chloride, silica, and lead chloride. Gold, platinum, selenium, and tellurium must be recovered from solution, and other accompanying elements are eliminated by wastewater treatment.

Copper anode slime is reportedly digested in a high-pressure process, either after the removal of copper or after one of the roasting processes [56]. Temperatures between 160 and 180 °C are recommended. If 10–40% sodium hydroxide solution is used, selenium and tellurium go into solution, while silver and most of the copper remain undissolved. If dilute sulfuric acid is used in the presence of air, selenium, tellurium, silver, and copper dissolve. Problems arise if selenium and tellurium exceed an oxidation state of 4. Solutions of selenate(VI) and tellurate(VI) cannot be readily reduced to the elements. The favorable economics of the pressure process are mainly a consequence of the improved sharpness of separation compared to other processes and of the short reaction times.

**Processing of Copper Anode Slimes in a Cupellation Furnace.** If pretreated anode slimes contain only moderate amounts of copper, selenium, tellurium, antimony, and arsenic, the noble metals can be recovered in a cupellation process. However, a two-stage process in separate furnaces is necessary for treating the low-grade and high-grade materials.

**Processing of Copper Anode Slimes in the Doré Furnace.** In the Doré process, pretreated anode slimes (i.e., with copper removed) are treated with slag-forming and oxidizing materials for a long period in the molten state. In addition to the crude silver fraction, three

types of slag are usually produced and removed separately. Flue dust is also obtained.

Sodium carbonate, lime, cullet (broken glass), and sand are added to form a silicate slag that takes up primarily iron, arsenic, antimony, lead, nickel, and tin. Selenium matte, which consists mainly of selenides and tellurides of copper and silver, forms an intermediate layer between the silicate slag and the molten metal if the starting material has a high selenium and tellurium content. After removal of the silicate layer, selenium matte is blown with air and treated with sodium carbonate and sodium nitrate. This produces a slag that contains sodium selenite, sodium selenate, sodium tellurite, sodium tellurate, and only ca. 1% silver. This slag is tapped off, and the molten metal is reacted with additional sodium nitrate to remove the remaining copper, lead, selenium, and tellurium. The doré silver produced has a noble-metal content of 99.0–99.5% and is sent to the silver electrorefining process. Its main impurity is copper, but it also contains some lead, bismuth, selenium, and (depending on the starting material) tellurium. Doré furnaces are usually oil fired along their length, and are similar to German fixed hearth or English tilting hearth cupels. For hearth sizes between 3 and 6 m<sup>2</sup>, a charge of 8–15 t anode slime is treated in 100–200-kg lots. The reaction time is 3–6 d or longer. Waste gases are passed through dedusting chambers, coolers, scrubbers, and electrostatic gas purifying equipment.

Slags produced by oxidation of selenium matte, and flue dust and slimes from the scrubbers are major sources of selenium and tellurium. The most valuable material in the wash liquor is selenium. All other drosses, including residues from selenium and tellurium production, which contain noble metals, are recycled to the copper shaft furnace or to the doré process.

Typical compositions of intermediate products are given in Table 24.3. These can, however, vary over a wide range.

**Table 24.3:** Percentage composition of intermediate products from copper anode slimes and copper matte.

	Ag	Au	Se	Te	As	Sb	Bi	Cu	Pb	Ni	SiO <sub>2</sub>
<b>Cupellation</b>											
After melting	1		1		3	10		4	40	5	10
Tapped off selenium matte	20	0.1	20						25		
Tapped off litharge	1		0.5			2	3	10	60		
Argentiferous lead	40	0.5	1					5			
Auriferous silver	97	2									
<b>Doré Process</b>											
Selenium matte	55	0.1	25	4				13	1		
Selenite-tellurite slag	1		18	6				2			
Potassium nitrate slag	4		6	1				16			
Flue dust	4	0.3	30	3		10		5			
Gas scrubber sediment	10	0.2	35	2				0.5			
Crude metal (before treatment with NaNO <sub>3</sub> )	79	4	4	1				4	1		
Doré metal	95	4	<0.1				<0.1	1	0.1		
<b>Ziervogel Process</b>											
Mansfeld copper matte (before Ziervogel process)	0.5							75			
Mansfeld copper matte (after Ziervogel process)	0.02										

**Treatment of Copper Anode Slimes with Molten Salts.** Powdered anode slimes can be digested below their melting point, without forming molten metal by fusing with  $\text{Na}_2\text{CO}_3$  and  $\text{NaNO}_3$  or similar mixtures. The reaction is also possible at sintering temperature. After leaching with water, a separation process must be used similar to that used after acidic hydrometallurgical digestion of copper anode slimes.

**Other Methods of Processing Copper Anode Slimes.** Dried, decopperized anode slimes can be treated with chlorine at ca. 700 °C. Silver chloride remains in the residue, and the chlorides of selenium, tellurium, copper, tin, arsenic, etc., are sublimed or distilled.

If the decopperized anode slimes are heated to 700 °C in a vacuum, silver selenide decomposes and selenium sublimes.

#### 24.4.3.4 Silver Extraction from Copper Matte

Before electrolytic technology became available for refining copper, copper-silver separation had to be performed on copper matte from the copper shaft furnace. Two main processes were used.

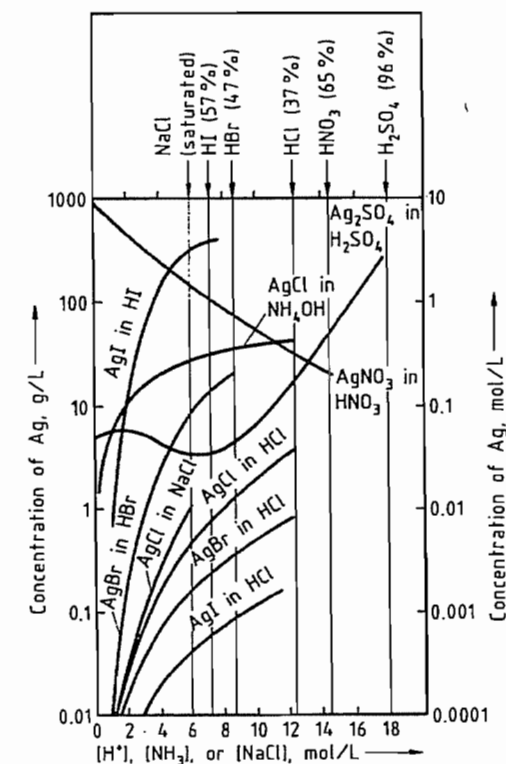

**Figure 24.3:** Solubilities of silver compounds in aqueous electrolytes at 20 °C.

- In the Augustin process, copper matte was roasted under chloridizing conditions, and the silver chloride formed was leached out with hot brine, leaving behind the unchanged copper sulfide (Figure 24.3).
- In the mid-1800s, the Augustin process was replaced by the Ziervogel process, which involved sulfation roasting of powdered copper matte with a precisely controlled temperature program. This first decomposes silver sulfide to silver and sulfur. The silver reacts with sulfur trioxide liberated from iron sulfate and copper sulfate, forming the more stable silver sulfate, which is water soluble. The copper is then in the form of copper(II) oxide. Treatment with water acidified with a little sulfuric acid dissolves silver sulfate, leaving copper(II) oxide in the residue. More than 90% of the silver goes into solution, 5% is in the flue dust, and the rest stays in the copper oxide (Table 24.3). Gold is undissolved and remains in the copper. Thus, the gold content of copper matte cannot be recovered by the Ziervogel process.

#### 24.4.4 Extraction from Gold Ores

The silver present in most gold ores follows the gold in all pretreatment processes, as well as in the aqueous cyanide process. Crude gold as mined usually contains 10–12% silver. In the commonly used Miller process, silver and base metals are separated from gold by conversion to their chlorides (AgCl, CuCl, etc.). The reaction is carried out by passing chlorine through the molten metal. Silver chloride and the base-metal chlorides form a slag on the molten gold to which borax is added as a flux. Solidified slag is leached with a solution of sodium chlorate in hydrochloric acid, which dissolves the base-metal chlorides and leaves silver chloride as residue. The silver chloride is reduced with zinc dust in suspension to precipitate crude silver, which is then electrorefined.

Small amounts of silver and gold are also recovered from sodium carbonate-containing slag and broken crucible fragments from the

melting of precipitated gold in the cyanidation process. These materials are treated by the lead–silver blast furnace process and the cupellation process.

#### 24.4.5 Extraction from Tin Ores

Silver-containing concentrates from the treatment of Bolivian tin ores usually contain a few hundred parts per million of silver, present mainly as sulfidic compounds. The ore is roasted under oxidizing conditions in the presence of sodium chloride, to convert silver to silver chloride, which can then be leached out. Alternatively, the concentrates can be treated by an amalgamation process, with or without a preliminary roasting operation. A more economical solution is often to add these materials to the feed for the copper smelting process. Silver then ends up in anode slimes from the electrorefining of copper.

**Leaching with Hydrochloric Acid or Aqueous Sodium Chloride.** Leaching with HCl is carried out at ca. 100 °C. Tin dioxide is not dissolved, but most of the other materials are, including silver. Silver can be cemented with scrap iron. The cementate produced is treated in copper or lead smelting processes.

**Leaching with Aqueous Thiosulfate.** When the silver content is high, aqueous thiosulfate is often used because of the high and selective solubility of silver chloride in thiosulfate. The process was formerly used widely to treat true silver ores.

#### 24.5 Recovery from Secondary Silver [3, 19, 35–40, 54, 55]

The collection and treatment of silver-containing scrap and residues is of major economic importance. These materials can be divided into metallic products that can be melted to form a homogeneous material and nonmetallic concentrates (drosses, see Section 24.3.4). As in the production of silver from ores, the aim is to obtain a crude silver that can be treated in the refining process. Only seldom

is good-delivery silver obtained that does not need refining.

#### 24.5.1 Via Copper Smelters

In principle, all silver-containing recycled materials can be treated in the usual copper production processes. Since the silver is tied up in the process for a long period, only a few types of silver-containing scrap are treated in this way. Copper must be the principal base metal present. This category of scrap includes fabrication waste and recycled material from the electronics industry. Usually, they would be fed to the copper shaft furnace or the cupel. Flue dust and copper matte from the lead silver blast furnace are also treated in copper smelters.

#### 24.5.2 Via Lead Smelters

The only use of lead smelters in silver recycling is in treating the silver-containing flue dusts from lead silver blast furnaces. These smelters are very suitable for dealing with the high lead and zinc content of flue dusts.

#### 24.5.3 Via the Lead–Silver Smelting Process [22, 23, 56]

Some companies that recover noble metals from scrap use a special lead-based smelting process. The pyrometallurgical reactions are the same as those used for noble-metal extraction in ancient times and correspond in principle to those of the modern lead smelting process. There are two main stages of the pro-

cess: the blast furnace stage and the oxidation stage. In the blast furnace, silver and the other noble metals are taken up by lead bullion formed in the process. In the oxidation furnace (converter), the lead is then oxidized to lead oxide (PbO, litharge). The main product is a metal with a high percentage of silver (auriferous silver). Lead oxide is recycled to the blast furnace blast. The accompanying elements that enter the system in the raw material are eliminated via three by-products of the blast furnace: copper matte, slag, and flue dust. Slag, which contains the oxide and silicate components, is worthless and can be discarded. Copper matte, which contains the chalcophilic elements copper and nickel, and flue dust, which contains zinc and cadmium, must be treated separately.

Nonmetallic concentrates (drosses) containing noble metals are generally smelted in the lead–silver blast furnace. Metallic scrap materials are often treated directly in the converter. In this case, base metals go into the litharge, though some are in the flue dust. The choice of treatment process is often determined by the cost of tying up the value of the noble metal, thereby incurring loss of interest, rather than by actual operating costs.

Typical compositions of materials involved in the lead–silver smelting process are given in Table 24.4.

**The Blast Furnace.** In the blast furnace (Figure 24.4), the following reactions take place:

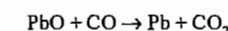
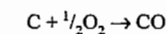

Table 24.4: Typical compositions of materials produced during noble-metal smelting.

Source	Material	Ag	Au	Nonnoble impurities, %											Relative quantities, t	
				Cu	Pb	S	Halo-gen	Fe	Ni	Zn	Cd	Sn	SiO <sub>2</sub>	Al <sub>2</sub> O <sub>3</sub>		CaO
Blast furnace process	slag	100 ppm	2 ppm	0.5	1			15		2			35	20	15	30
	copper matte	3%	100 ppm	40	10	25		15	1							3
Cupellation process	lead bullion	20%	1%	15	60	1		2	2	4		3				6
	litharge	4%	100 ppm	15	60		2	2								6
Gas purification	auriferous silver	97%	1%	1	0.1											1
	flue dust	1%	100 ppm	3	20	2	25	2	1	8	3					1

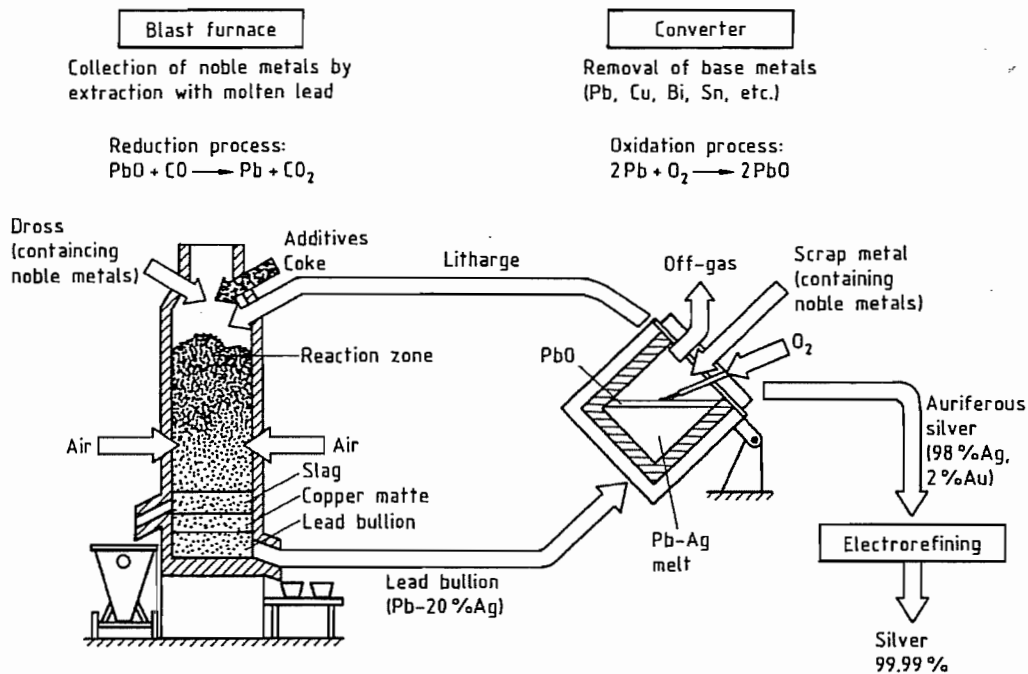

Figure 24.4: Silver recovery in a blast furnace and converter.

Here, lead is formed from the litharge produced in the converter and acts as a collector for noble metals. The chemical reactions, which also form the copper matte and slag phases, take place at 1100–1300 °C.

In the operation of the lead–silver blast furnace a large number of parameters must be controlled and various boundary conditions observed. The widely varying composition of the raw materials and of the recycled litharge, must be compensated by varying the amount of quartz, limestone, sulfur, iron oxide, pyrites, and coke added. This ensures the formation of a low-viscosity slag that does not incorporate droplets of metal. The amount of sulfur added is calculated from the amount of nonferrous metal. The ability of the slag to take up aluminum oxide is limited. If the  $Al_2O_3$  content reaches 20%, the slag viscosity increases. This must be taken into account when catalysts supported on  $\gamma$ - or  $\alpha$ -aluminum oxide are processed.

The ability of lead and auriferous silver to alloy with gold, platinum, and palladium is

unlimited. However, rhodium, iridium, ruthenium, and osmium, together with other refractory metals such as tungsten and molybdenum, collect at the bottom of the blast furnace or at the bottom of the converter. For this reason, as well as the volatility of ruthenium and osmium compounds in the blast furnace, the presence of these metals is undesirable. Halides in the raw materials end up almost completely in the flue dust in the form of lead and silver halides. Zinc and cadmium take the same route.

The elements arsenic, selenium, and tellurium are kept out of noble-metal smelters as much as possible because they form compounds with noble metals (speisses) that are difficult to process.

Instead of using a blast furnace, the lead smelting stage can be operated in a flame-fired furnace. This, too, is followed by an oxidation stage.

**Oxidation in the Top-Blown Rotary Converter.** The following reaction takes place in a converter:

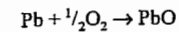

The molten lead oxide (litharge) produced is removed continuously from the surface of the liquid metal and recycled to the blast furnace. Silver and other noble metals remain in the elemental state and are concentrated from ca. 20% in the starting material (lead bullion) to ca. 99% in auriferous silver (Table 24.4). The lead oxide contains silver particle inclusions, appreciable quantities of copper, and small amounts of other accompanying base metals as their oxides (Table 24.4).

The oxidation of argentiferous lead was carried out for a long time exclusively in shallow flame-fired furnaces (cupels) like those used in the lead smelting process. Lead was oxidized by applying a flame and a stream of air to the surface of the melt. The reaction temperatures during cupellation were ca. 900 °C at the start and ca. 1100 °C at the end of the process. The lower limit is determined by the melting temperature of PbO (890 °C), silver (961 °C), and auriferous silver (ca. 1050 °C).

Since ca. 1975, top-blown rotary converters have been used instead of cupels. The oxidizing agent is gaseous oxygen [57]. Such converters contain several tonnes of metal, and the litharge is poured off through a spout. A natural gas oxygen burner produces very intense heating. The great economic advantages compared to conventional cupellation hearths result from the much higher rate of reaction due to convection in the melt, low energy requirements, improved working conditions, longer lifetime of the furnace lining and the potential for automation.

If scrap alloys are processed directly in the converter and not in the shaft furnace, to speed up noble-metal throughput, the litharge picks up more base metal, mainly copper. The copper can be removed in copper matte only after the litharge has been transferred to the blast furnace. Therefore the noble metal is sometimes concentrated by a preliminary treatment of the raw material.

Both the oxidation process with direct feeding of scrap metal and the shaft furnace process can be carried out with copper instead of

silver. This is appropriate if the raw material has a high content of platinum-group metals that do not readily form alloys with silver (e.g., rhodium). The copper oxide formed is then usually processed by leaching with sulfuric acid.

#### 24.5.4 Via Scrap Metal Leaching [58]

Alloys based on silver–copper, which can also contain nickel, zinc, other base metals, gold, and platinum-group metals, can be treated hydrometallurgically to recover the noble and base metals.

The basis for this is the very wide miscibility gap between silver and copper in the alloy system. Copper can be selectively dissolved by dilute sulfuric acid, with addition of air, gaseous oxygen, or hydrogen peroxide:

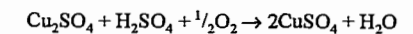
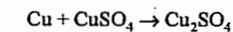

Copper can also be oxidized in a prior roasting stage. Dissolution by sulfuric acid is then possible without addition of oxidizing agents. The preferred reaction temperature is ca. 90 °C. In the concentration range Ag 30 Cu 70 to Ag 70 Cu 30, the silver in the alloy retains its structure during the process. The reaction rate decreases nonlinearly with increasing depth of attack due to the restriction of diffusion through the silver skeleton. For acceptable times of solution, the thickness of the alloy pieces should not exceed 0.1–0.2 mm. This can be achieved by machining the alloy to form chippings or by spraying the molten metal to form a powder. In both cases, a material is obtained that can easily be kept in suspension by stirring. If the solidified metal is slowly cooled to ca. 200 °C, formation of mixed crystals on the silver-rich side of the system can be inhibited, which increases the rate of copper dissolution. The silver that remains behind is generally electrorefined. Copper sulfate or electrolytic copper can be recovered from solution.

Silver-containing alloys can be dissolved in nitric acid or hydrochloric acid, and



silver can be precipitated as silver chloride. However, this is not economical on an industrial scale. Copper nitrate can be converted to copper oxide or copper(I) chloride. Copper cementation processes are seldom carried out because of environmental problems.

### 24.5.5 Via Scrap Metal Electrolysis [59]

**Dietzel Electrolysis** (Figure 24.5) [60]. A recycled alloy, usually of silver, gold, and copper, is anodically dissolved in an electrolyte of slightly acidified copper nitrate. The anode and cathode spaces are separated by a textile diaphragm. The anolyte is removed continuously via an overflow, and silver is precipitated from it by cementation with copper. The desilvered anolyte is fed continuously into the cathode space, where copper is deposited on rotating roller-shaped cathodes and is removed in sheet form from time to time. The flow of desilvered solution into the cathode space, and the outflow of silver-containing solution from the anode space, which is caused hydrostatically, produce a flow of solution through the diaphragm in the direction of the anode. Very little dissolved silver reaches the cathode space. Copper with a low silver content is recovered at the cathode. This copper is electrorefined, whereby a gold-containing anode is produced.

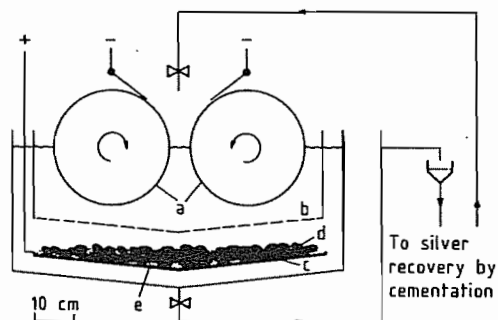

**Figure 24.5:** Dietzel electrolysis (front view): a) Roller-shaped cathodes; b) Diaphragm; c) Anode; d) Pieces of scrap silver; e) Anode slime.

The process is still used industrially. One disadvantage is the high cost of equipment.

Several variations of the process have been described [61].

**Demag Electrolysis** [61]. Copper can be dissolved from silver copper anodes by a dilute sulfuric acid electrolyte and deposited on the cathode, while silver remains undissolved. If the metal has an average silver content, as is necessary for the sulfuric acid leaching of scrap silver, a felt-like mass of silver is produced that retains the shape of the original anode. With increasing depth of penetration into the anode, the dissolution reaction is inhibited by the silver structure, which presents diffusion. Therefore, the thickness of the anode sheet must not exceed ca. 5 mm. If anode baskets are used, avoiding the production of zones from which the copper has not been completely removed is even more difficult.

As dissolution proceeds, the current voltage characteristic of the electrolytic cell changes. Potentiostatic control of electrolysis is therefore essential to prevent excessive voltage, which would cause silver to dissolve and be deposited with copper on the cathode. As in the sulfuric acid dissolution process, preliminary thermal treatment must be carried out to prevent excessive amounts of copper from appearing in the silver crystals due to the formation of silver-copper mixed crystals. Also, the copper-containing electrolyte must be carefully washed out of the silver felt, which contains very fine pores.

Electrolysis in sulfuric acid also removes the other metals that usually accompany copper and silver, but nickel accumulates in the electrolyte where it causes problems. If zinc, cadmium, lead, and tin are present in the recycled alloy, it should be oxidized first in a converter. Tin, especially, can interfere with electrolysis by precipitation of stannic acid.

### 24.5.6 Processing of Flue Dust

Flue dust from the waste gases of the lead-silver smelting process nearly always contains silver. Flue dust can be recovered quantitatively by means of settling chambers, electrostatic processes, wet and dry filtration, and scrubbing towers.

Dust from the lead-silver shaft furnace and the cupel generally contains the following: lead(II) oxide, lead sulfide, silver sulfide, elementary silver, copper oxide, copper sulfide, slag components, etc. It can normally be recycled to the shaft furnace.

If halides, mainly from photographic materials, are introduced into the smelting process, they are essentially bound as halides of lead and silver, which because of their low boiling points ( $bp$  of  $PbCl_2 = 916^\circ C$ ), are found almost entirely in the flue dusts. If the flue dust is recycled to the shaft furnace the halides revolatilize, and only the other components form slags or are reduced. The halide content of flue dust increases due to the recirculating system, and when it exceeds a certain figure, the dust is treated with sodium carbonate solution or milk of lime. Soluble halides are disposed with wastewater. All heavy metals, nonferrous metals, and noble metals remain as oxides, carbonates, or metals in the residue, which is fed back to the shaft furnace process.

Like the halides, the elements zinc and cadmium become concentrated in the flue dust, passing unchanged through the reducing shaft furnace due to their vapor pressure if they have not already been removed in the slag during cupellation or by distillation from the feed material. After sufficient concentration, they are dissolved as sulfates by treatment with sulfuric acid. The main component of the residue, which is fed back to the shaft furnace, is lead sulfate. The distribution of silver between the solution and the residue must be monitored.

The arsenic, antimony, selenium, and tellurium in flue dusts are especially troublesome. Noble-metal smelters attempt to remove these elements, which are readily sublimable in the elemental state, before the flue dust is introduced into the recycling system. Recycling of dusts of this type is usually confined to copper and lead smelters, where the elements can be picked up in the slag, either in the shaft furnace or the dore furnace.

### 24.5.7 Processing of Copper Matte [62]

Because of its high silver content, copper matte (see also Section 24.4.3.4) from the lead-silver shaft furnace used in noble-metal smelting must be treated without delay to minimize interest losses. Silver can be recovered quickly by the lead shaft furnace process, followed by isolation of silver by the Parques process. Treatment in the shaft furnace of a copper refinery is possible, but silver is bound for a long time in the copper electrorefining stage and then in the copper anode slimes. In principle, copper matte can be ground, roasted in air, and leached with dilute sulfuric acid to dissolve the copper and leave a silver-containing residue. The same result is obtained by directly leaching ground copper matte with dilute sulfuric acid at ca.  $160^\circ C$  in autoclaves, with introduction of air. Direct electrolysis of copper matte anodes has also been proposed. Copper is deposited on the cathode, whereas silver remains in the anode slime. However, mechanically stable anodes are difficult to produce.

### 24.5.8 Processing of Photographic Materials [38, 40, 62]

**Films.** Film material in which the film base is nonuniform, and therefore difficult to reuse, is best treated by incineration, generally after size reduction in a cutting mill. The combustion temperature must be controlled carefully to minimize volatilization of the silver, which can lead to high losses in the combustion gases, and consequent high recycling costs. The durability of the furnace lining is also strongly dependent on temperature. Usual incineration temperatures are in the range of  $1000\text{--}1200^\circ C$ . The temperature can be lowered by water spraying [63].

If pyrolysis [64] is used rather than incineration, flue dust problems are largely avoided. The end products of incineration of pyrolysis can be treated by smelting or electrorefining, depending on the silver content. In pyrolysis, temperatures of  $600\text{--}700^\circ C$  are used. If the

film substrate is to be reused, a washing process is employed that destroys the gelatin coating and liberates silver or silver halide. Suitable washing solutions include hot dilute sulfuric acid, hot dilute sodium hydroxide solution, sodium hypochlorite solution, or enzyme solutions [65]. If developed films are to be treated, the grains of silver can be oxidized with a solution of iron(III) chloride, and the silver halide formed can be washed off with a solution of sodium thiosulfate. The silver concentrates, which must be reduced to silver if silver halides are present, generally have a sufficiently high silver content to be treated by electrorefining.

Older films, such as those from archives, must be tested carefully to determine whether they are made of extremely flammable nitrocellulose film material. The storage of such materials requires elaborate safety precautions.

**Photographic Paper.** Washing processes are uneconomic because the silver content of photographic papers is low and the substrate materials cannot be reused after washing. Instead, silver is usually recovered by incineration or pyrolysis.

**Photographic Emulsions.** The photographic industry produces unusable, usually pasty or lumpy residues of photographic emulsions, which are supplied to recovery plants for treatment. Apart from silver halides, they contain water and considerable amounts of gelatin. Treatment can be by combustion, pyrolysis, or chemical breakdown of the gelatin in solution or suspension. The silver halides can be reduced at the same time or in a subsequent operation. The isolated silver halides can be converted into metallic silver by fusion with sodium carbonate or by hydrometallurgical reduction.

**Fixing Baths** [66–73]. Silver-containing fixing baths from photographic plants and laboratories, hospital X-ray departments, and doctors' surgeries are rarely sent directly to recovery plants. They are generally treated chemically or electrochemically in situ to pre-

cipitate the silver. Alternatively, they may be purchased by specialist companies that convert them to concentrates and detoxify the highly contaminated wastewater.

In times of high silver prices, ca. 75% of all fixing baths are treated to recover the silver in spite of their wide dispersal. In addition to the economic value of the silver recovered from fixing baths, ecological considerations are important.

In concentrations of > 0.04 ppm, silver ions have harmful effects on biological systems. However, these effects are much reduced if the silver in photographic wastewater is in the form of a complex. The potentially harmful effects on biological wastewater treatment systems are prevented by rapid reaction of dissolved silver with the sulfide that is always present in such systems to forming insoluble and, therefore nontoxic, silver sulfide. Although no harmful effects on biological sewage treatment plants have been observed in practice, the silver concentration in wastewater passing into the main drainage system is usually limited to 1–2 ppm.

Many processes have been used to treat silver-containing fixing baths. Chemical precipitation processes have largely been displaced by electrolytic processes for ecological reasons. The original method of precipitating silver sulfide from the fixing bath by adding sodium sulfide is obsolete and unacceptable for reasons of industrial hygiene. Precipitated silver sulfide was often reacted with iron powder above the melting point of silver to form metallic silver and iron sulfide. Later, silver sulfide was precipitated by adding trimer-capto-*s*-triazine [71]. This reaction takes place without liberation of hydrogen sulfide and can be followed potentiometrically. The method is also suitable for treating the much more dilute fixing and bleaching baths from color photography, for rinsing solutions, and for wastewater that contains copper, cadmium, mercury, nickel, and lead. Final concentrations of ca. 1 mg/L silver are obtained. The cementation of silver with zinc powder is dangerous due to the hydrogen evolved and has led to severe accidents. It also produces

zinc-containing wastewater. The use of sodium borohydride as reducing agent has been suggested, although this also results in evolution of hydrogen. The use of sodium dithionite as a reducing agent is recommended in the photographic industry:

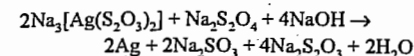

Most fixing bath treatment companies now use a process in which silver is recovered quantitatively by electrolysis. Fairly pure silver is removed from the stainless steel cathodes in the form of sheets and budlike growths. In large laboratories and hospital X-ray departments, part of the silver is recovered continuously in electrolytic cells, so that the fixing bath can be used for a longer period and no longer need be discarded so frequently and replaced with new material. For smaller laboratories and doctors' surgeries, the recovery of silver from fixing baths is carried out by using containers packed with steel wool [72]. The spent fixing bath solution is run through slowly, whereby silver is reduced and precipitates on the steel wool. The suppliers take back the containers with the silver and send them to recovery plants.

Electrolysis equipment [73, 74] of various sizes is also rented out by many business establishments who undertake the refining and purchase of the silver produced. This system has become important mainly in European countries except Germany [75].

The complex-forming thiosulfate in the fixing bath can be decomposed by sodium hypochlorite or chlorine and neutralized with sodium hydroxide solution:

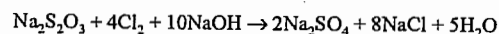

The silver chloride formed can be filtered off and reduced. In practice, oxidation with hydrogen peroxide is often preferred [76]. The advantages are ease and safety in handling, and the avoidance of contamination with toxic chlorinated organic substances. The reactions are

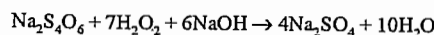
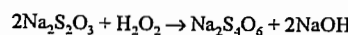

which can be summarized as

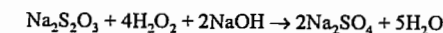

This can be taken to either the tetrathionate or the sulfate stage, depending on the desired BOD value of the wastewater produced. The silver precipitates as a mixture of  $\text{Ag}_2\text{O}$ ,  $\text{AgBr}$ , and  $\text{Ag}_2\text{S}$ .

In low-silver fixing baths (e.g., washing baths or fixing baths from which silver has been removed electrolytically) the small amounts of residual silver can be removed by ion exchange [77–79].

## 24.5.9 Surface Desilvering

In silver-plated material for jewelry, the base metal is usually German silver, a copper–nickel–zinc alloy. The base materials of silver-plated electronic components are generally copper–iron, iron–nickel–cobalt alloys, or brass. In addition they contain tin as a brazing alloy component and gold as a contact material. In electrical low-current contacts, carrier materials for the silver coating can be copper, copper–tin, copper–beryllium, brass, German silver, or copper–nickel–tin.

The processing of these materials in the lead–silver smelting process (see Section 24.4.2) is uneconomical. The large amounts of copper result in formation of additional copper matte, which can often incorporate more silver than is introduced in the scrap material. Nickel and iron lead to the formation of undesired furnace bottoms. Silver-plated materials are better treated by the copper-smelting route (see Section 24.4.3), which allows recovery of copper, nickel, silver, and gold in high yield. A disadvantage is that the noble metal is tied up for a long period.

In the dissolution of silver coatings from metallic substrates by acid treatment, both silver and the base metal are attacked, especially in the reaction of nitric acid with German silver. A mixture of concentrated sulfuric acid and concentrated nitric acid gives better results. Silver-plated items may also be reacted with hot sodium polysulfide solution, which rapidly and selectively converts the silver to

silver sulfide. The sulfide coating can then be removed by mechanical or thermal shock, or by reduction with aluminum or reducing agents, e.g.:

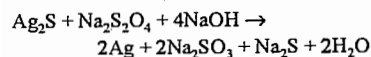

The dissolution of silver coatings in sodium cyanide solution in the presence of oxygen is slow and therefore suitable only for very thin films (a few micrometers), such as those on electronic products. As with gold, higher rates of dissolution are achieved if water-soluble aromatic nitro compounds (e.g., nitrobenzene-sulfonic acid or nitrobenzoic acid) are used as oxidizing agent instead of air [80]. When the base material consists of copper or copper alloys, unwanted side reactions of the type

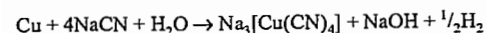

are difficult to avoid. Silver can be obtained from the resulting solution by electrolysis or by decomposition of the cyanide with chlorine.

### 24.5.10 Processing of Special Scrap

Silver residues for recovery often arise in combination with other valuable materials. In these cases, conventional processes may fail, either because the accompanying substances cause problems, or because they cannot be recovered. In many cases (e.g., Ag- $\alpha$ -Al<sub>2</sub>O<sub>3</sub>, Ag-W, Ag-Ta), silver can be dissolved by nitric acid without attacking the accompanying material. More reactive metals such as aluminum, nickel, tin, cadmium, or indium can generally be dissolved even if they are alloyed with silver by using acid, acid mixtures, or alkali, or by anodic dissolution, leaving silver as the residue.

Before dental amalgam wastes are treated chemically to recover silver, they are usually heated to > 500 °C in closed equipment with strict control of the surrounding atmosphere to distill the mercury.

## 24.6 Silver Refining [2, 3, 19, 54, 59, 81]

Crude silver, from ores in primary production and from recycling operations generally has a purity of 98–99.5%, which may include gold and platinum-group metals because these processes only separate noble metals from base metals.

The main task of silver refining (world output: 10 000 t/a) is the production of silver with a purity of > 99.9% and > 99.97%. A purity of > 99.99% is increasingly being specified for industrial applications. The first and most important task is the recovery of gold and platinum metals from crude silver. The value of the gold in doré silver and auriferous silver often exceeds that of the silver itself. The refining of silver therefore generally includes a gold-silver separation process. Before refining, the noble metals are in very concentrated form, so the process must involve the shortest possible tying-up of the noble metal.

### 24.6.1 Fine Smelting

If the crude silver contains hardly any gold or platinum-group metals, silver of fineness 999/1000 can be obtained by an oxidation process, generally carried out in a separate refining furnace. The purification process is improved by adding alkali-metal nitrates, alkali-metal carbonates, or silver sulfate, and by blowing with oxygen.

### 24.6.2 Refining with Nitric Acid (Inquartation) [3]

The long-known process of dissolving a silver-gold alloy in nitric acid is still used today, although to a minor extent. Silver dissolves according to the equation

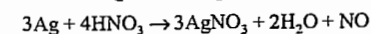

(Figure 24.1), and the gold remains undissolved. The separation becomes increasingly efficient as the composition of the alloy approaches Ag 75 Au 25. Ag-Cu-Au alloys can also be treated by this process. In addition to silver, the base-metal components and most of

the platinum metals are dissolved. Silver nitrate can be isolated from the solution; metallic silver can be obtained by cementation or electrolytic reduction; or silver chloride can be precipitated. Historically, the process was temporarily replaced by the sulfuric acid separation process, because of the high consumption of nitric acid and the large amount of recycled noble metal. Its advantage is rapid recovery of the 'gold. Hence alloys' with high gold content (e.g., 10–20%) are treated by this process.

### 24.6.3 Refining with Sulfuric Acid (Affination) [3]

Silver-gold alloys are treated with ca. 86% sulfuric acid at 240 °C, whereby the silver is oxidized according to the equation



and remains in solution as the more soluble silver hydrogensulfate. The solution is diluted with water to precipitate silver sulfate, which is filtered off and treated with iron in a cementation process. The silver sulfate still in solution is treated by cementation with copper to produce copper sulfate. This refining process can deal with a wider range of alloy compositions than the nitric acid process (Section 24.6.2). The alloys treated may contain appreciable amounts of copper. Also, the consumption of acid is much lower than in the nitric acid process. On the other hand, this refining process requires more costly equipment and results in considerable off-gas problems. The sulfuric acid process has not been used since World War II.

### 24.6.4 Möbius Electrolysis [22, 23]

The Möbius electrolysis process for refining silver is used mainly in Europe (Figure 24.6). A silver nitrate-sodium nitrate-nitric acid electrolyte is employed. Silver and the accompanying base metals are dissolved by anodic oxidation, and the concentration and current-voltage ratios are controlled so that only silver is deposited at the cathode. Cast

crude silver anodes are suspended and surrounded by anode bags in which anode slime collects. This contains all the gold in the form of metal, selenide, or telluride, as well as platinum-group metals, silver particles that become detached, lead dioxide, and oxidic copper compounds. Dendritic silver crystals are deposited on the stainless steel cathode sheet and removed continuously by automatic scrapers to prevent short circuits. Copper accumulates in the electrolyte. If the concentration of copper becomes too high, it can deposit with the silver, and the purity specification may not be met. The same is true of selenium. Palladium goes partly into solution but separates on the cathode to a very minor extent.

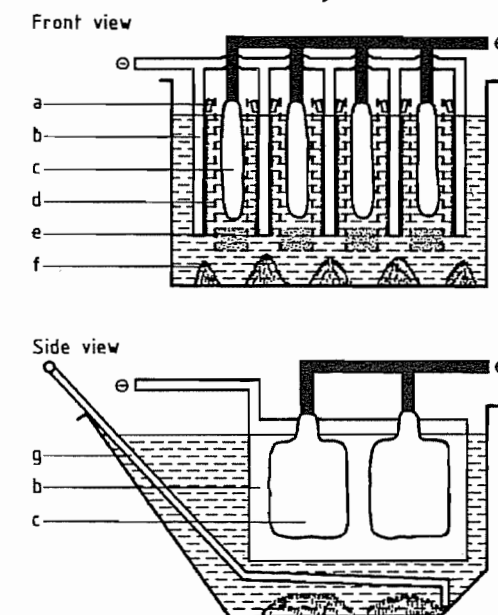

Figure 24.6: Silver electrorefining by the Möbius process: a) Scraper; b) Cathode (stainless steel); c) Anode (crude silver); d) Anode bag; e) Anode slime (gold, platinum-group metals); f) Silver crystals; g) Scraper.

The silver concentration in the electrolyte is ca. 50 g/L, with 10 g/L of free HNO<sub>3</sub>, and the anodic current density is 400–500 A/m<sup>2</sup>. The cell voltage is 2.0–2.5 V. The anodes and cathodes are usually arranged in parallel in the cell, and the energy consumption is ca. 0.6 kWh/kg of pure silver. To compensate for the anodically dissolved base metals that are not

removed at the cathode (mainly copper), silver nitrate solution is fed into the electrolyte to prevent depletion of silver.

At one time, the Möbius process had to be interrupted to remove crystals of fine silver. The anode and cathode carrying device was lifted from the bath, and the perforated false bottom was raised to enable the silver crystals to be collected. Today, cells are usually constructed so that the silver crystals can be scraped manually over the edge of the vessel without interrupting electrolysis (Figure 24.6). The spent anodes are replaced continually by new anodes, so that interruption of electrolysis is necessary only if the electrolyte must be replaced due to excessive copper concentration, or if the anode bags have to be emptied. The electrolyte is usually treated with copper to recover the silver by cementation, and the copper is then recovered by cementation with iron. The electrolyte can also be treated by chemical precipitation methods or by the "black melt" process in which a mixture of silver nitrate and copper nitrate is obtained by evaporating to dryness (see Section 24.7.1). The main accompanying metal, copper, is reported to be removed by liquid-liquid extraction, in which case the remaining silver-containing solution could then be returned to the system [82, 83].

The Möbius electrolysis process is most suitable for crude silver containing > 90% Ag. With high copper content, the electrolyte must be regenerated too often, and with high gold content, the anode bags require frequent emptying. Both are costly operations. A single electrolysis gives a purity of 99.95–99.99% Ag and a double electrolysis gives a purity of 99.995–99.999%.

### 24.6.5 Balbach-Thum Electrolysis [22, 23]

The Balbach-Thum electrolysis process uses virtually the same electrochemical conditions as the Möbius process. Only the geometrical arrangement is different (Figure 24.7). The anodes and cathodes are arranged horizontally. Each cell is provided with only one

anode and one cathode. The cathode is a stainless steel plate covering the entire floor area. Above this, at a distance of 10 cm, is a slightly smaller framework of nonconducting material, covered with fabric and containing the anodes. The anode and cathode are supplied with electric current via silver contacts. The crude silver anodes are completely covered by electrolyte, and therefore completely dissolved, unlike the anodes of the Möbius process, which leave behind some unconsumed metal. Another advantage of Balbach-Thum electrolysis is that the anode slime is recovered more easily, which is especially important when the crude silver has a high gold content. Disadvantages include the large space requirement and high energy consumption. The Balbach-Thum process is used mainly in the United States.

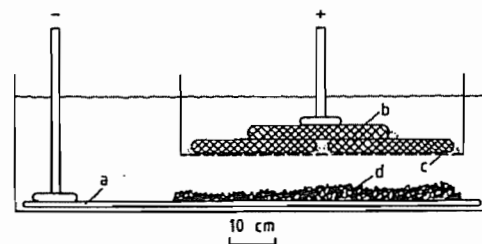

Figure 24.7: Balbach-Thum electrorefining: a) Cathode; b) Silver anode; c) Diaphragm; d) Silver crystals.

## 24.7 Inorganic Compounds

[19, 84–86]

### 24.7.1 Silver Nitrate [2]

**Properties.** Silver nitrate, theoretical silver content 63.50%, colorless rhombic crystals, *mp* 209 °C, temperature of transformation to the trigonal form 160 °C, decomposition temperature 444 °C, density 4.352 g/cm<sup>3</sup> (Table 24.5), is very soluble in water, the solubility being strongly dependent on temperature (Figure 24.8), with complete miscibility in the AgNO<sub>3</sub>-H<sub>2</sub>O system at > 159 °C. Its solubility in water is decreased considerably by the presence of nitric acid (Figure 24.1). The solubility in ethanol is 20.8 g/L, in methanol 35 g/L, and in benzene 2.2 g/L.

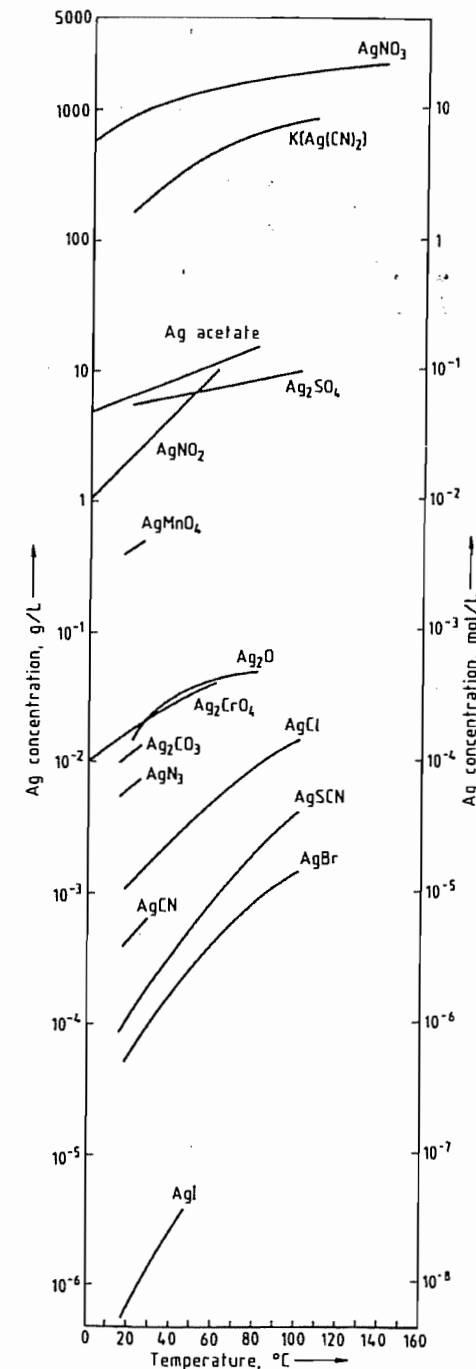

Figure 24.8: Solubilities of silver compounds in water as a function of temperature.

Table 24.5: Saturated solutions of silver nitrate in water.

Temperature	AgNO <sub>3</sub>				Density, g/cm <sup>3</sup>
	g per 100 mL H <sub>2</sub> O	g/L of solution	molarity	%	
-7	94	773	4.6	48.5	1.60
0	115	909	5.4	53.5	1.70
10	160	1170	6.9	61.5	1.90
20	215	1438	8.5	68.2	2.11
25	241	1551	9.1	70.7	2.19
30	282	1710	10.0	73.8	2.32
40	335	1892	11.1	77.0	2.46
50	400	2083	12.3	80.0	2.60
60	471	2261	13.3	82.5	2.74
80	652	2608	15.4	86.7	3.01
90	762	2768	16.3	88.4	3.13
100	1024	3052	18.0	91.1	3.35
110	1105	3120	18.4	91.7	3.40
125	1624	3430	20.2	94.2	3.64
133	1941	3552	20.9	95.1	3.74
> 159	∞				

Silver nitrate has an oxidizing action on organic materials, which can lead to ignition and combustion, sometimes with explosion. Silver nitrate is decomposed even by traces of dust, with formation of finely divided, black silver. The reaction is accelerated by light. Silver nitrate and its solutions are unstable toward light over long periods.

**Production.** Silver nitrate is generally produced by dissolving pure silver in hot 32% nitric acid:

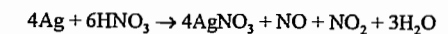

If all the nitrogen dioxide is recycled by reaction with the water in the system to form nitric acid (see below), the overall reaction is

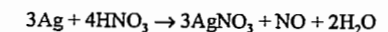

In practice, the mass balance lies somewhere between these two equations. A slight excess of nitric acid is required, which can be recovered when the product is crystallized by evaporation. Many producers pass oxygen or air through the reaction mixture, giving improved recovery of nitric acid:

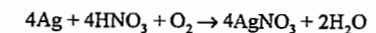

However, the formation of nitrogen oxides can be largely suppressed by using a closed vessel, so that off-gas treatment can be avoided. The nitrogen oxides produced were formerly thermally decomposed at > 600 °C in a flame, to

produce nitrogen and oxygen, but energy costs are high. An alternative method is to use the reactions

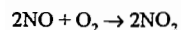

and

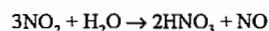

or the direct reaction

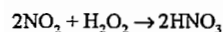

These processes are best carried out in countercurrent gas scrubbing equipment. The nitric acid formed is recycled to the process.

Since silver nitrate for the photographic industry is of a purity higher than that of refined silver (Table 24.11), a purification stage is required. The classical crystallization process is in principle very effective, but due to the high solubility of silver nitrate even in the cold (Table 24.1) and in the presence of  $\text{HNO}_3$  (Figure 24.1), the amount recycled is high. Precipitation and adsorption of copper, iron, lead, tin, etc., as their oxide-hydrates by the addition of silver(I) oxide are recommended. This is added to the weakly acid aqueous solution until the pH reaches 6. Chromatographic purification methods based on  $\gamma\text{-Al}_2\text{O}_3$  have also been described [87, 88]. Small traces of compounds of the platinum-group metals can lead to undesirable photochemical sensitization and can be converted into the inactive elemental form by irradiation with UV light [89]. Final purification can be carried out by heating molten anhydrous silver nitrate to ca. 350 °C, which mainly removes copper [19, 34]. At this temperature, silver nitrate does not decompose to the nitrite, but the decomposition temperature of most other heavy-metal nitrates to their oxides is exceeded. The copper oxide formed gives a dark-colored melt (black melt process). Precipitated impurities are removed by dissolving the product in water and filtering. The purified solution is then concentrated, and the silver nitrate is crystallized, washed carefully, and dried.

In the production of silver nitrate on an industrial scale, the equipment must be closed so that no loss of silver nitrate solution, aerosols, or dusts occurs. All operations can be carried out in stainless steel equipment.

The silver may be recovered from the mother liquor by cementation on copper, or the mixed nitrates can be treated by the black melt process to separate silver and copper. Alternatively, silver may be precipitated as silver chloride.

**Uses.** Most of the silver nitrate produced commercially is used in the photographic industry. Therefore, the quality specification for this application is the one in general use. Silver nitrate is also the starting material for the production of most other silver compounds and preparations, e.g., potassium dicyanoargentate(I), silver oxide, and supported catalysts. The process of electroless silver plating is also based on silver nitrate. Approximately 45% of the worldwide annual consumption of industrial silver (ca. 15 000 t) is in the form of silver nitrate.

### 24.7.2 Silver Halides

**Silver chloride**,  $\text{AgCl}$ ; **silver bromide**,  $\text{AgBr}$ , and **silver iodide**,  $\text{AgI}$  (Table 24.6 and Figure 24.8) resemble one another in properties. Silver astatide ( $\text{AgAt}$ ) is a member of this series, although it is likely to be sensitive to oxidation, even by atmospheric oxygen [90].

Silver halides become increasingly insoluble in the series  $\text{AgCl}$ ,  $\text{AgBr}$ ,  $\text{AgI}$ . Their solubility can be reduced further by addition of the respective common ion in low concentration. Higher concentrations of the common ion cause a marked increase in solubility due to the formation of complexes of the type  $[\text{AgX}_2]^-$  (Figure 24.3). Soluble complexes are also formed with thiosulfate, cyanide, and ammonia (see Section 24.7.6). Solubility in organic solvents increases with increasingly nonpolar character of the chemical bond from chloride to iodide.

Table 24.6: Properties of the sparingly soluble halides and pseudohalides of silver.

Property	$\text{AgCl}$	$\text{AgBr}$	$\text{AgI}$	$\text{AgCN}^a$	Silver isocyanate $\text{Ag-N=C=O}^b$	Silver thiocyanate $\text{Ag-S-C}\equiv\text{N}^c$	Silver fulminate $\text{Ag-C}\equiv\text{N-O}^d$	Silver azide $\text{Ag-N}_3$
Ag content, %	79.26	57.44	45.95	80.56	71.97	60.91	71.97	71.97
Crystal system <sup>b</sup>	cubic	cubic	hexagonal (< 150 °C) cubic (> 150 °C)	hexagonal	monoclinic	monoclinic	rhombic	rhombic
Density, g/cm <sup>3</sup>	5.56	6.473	5.683 6.010	3.95	4.00	3.746	4.09	4.09
<i>m.p.</i> , °C	455	430	557	350 (decomp.)	335 (decomp.)	224 (decomp.)	explosive	explosive
<i>bp.</i> , °C	1547	1533	1506					
Solubility at 20 °C, mg Ag/L								
Water	1.3	0.08	0.001	0.2		0.1	500	60
HMPT	0.12	0.08				20		10
Methanol	0.03	0.003	0.0001			0.01		0.3
Liquid $\text{SO}_2$	3300	25	100	200		130		

<sup>a</sup>The isomeric compounds corresponding to the tautomeric formulas  $\text{H-N}\equiv\text{C}$ ,  $\text{H-O-C}\equiv\text{N}$ ,  $\text{H-N=C=S}$ , and  $\text{H-O-N}\equiv\text{C}$ , are not known in all cases, or the isomerism is not well defined in the solid state; the nomenclature used in the literature is contradictory [19, 95, 97].

<sup>b</sup>High-temperature and high-pressure modifications also generally exist.

<sup>c</sup>Hexamethylphosphoric triamide.

All three compounds are sensitive to light and are used in photographic coatings on film and paper. Other industrial applications of silver halides are much less important.

Silver halides are produced almost exclusively by precipitation from aqueous silver nitrate solution by the addition of solutions of alkali-metal halides. Synthesis from the elements is also possible [91–93]. In the temperature range between the melting points of the metal and the halide, silver chloride, in particular, can be produced readily and economically.

### 24.7.3 Silver Oxides [2]

**Silver(I) oxide**,  $\text{Ag}_2\text{O}$ , theoretical silver content 93.10%, silver content of commercial product 93.0%,  $\rho$  7.143 g/cm<sup>3</sup>, is a dark brown powder with cubic crystal structure. It decomposes slowly at ca. 150 °C and rapidly at 300 °C.

Silver(I) oxide is formed when alkali-metal hydroxides are added to solutions of silver salts such as silver nitrate. Silver hydroxide cannot be isolated as an intermediate product, although an aqueous suspension of the sparingly soluble silver(I) oxide in water has a marked alkaline reaction. In electrolytes containing sodium hydroxide or in neutral electrolytes that do not produce sparingly soluble silver salts, silver(I) oxide can be produced by anodic oxidation of metallic silver.

Silver(I) oxide is used in considerable quantities (i.e., several hundred tons per year) in batteries (see Section 24.9.5). In organic synthesis, it is used to replace halogen atoms with OH groups.

**Silver(II) oxide**,  $\text{AgO}$ , theoretical silver content 87.08%,  $\text{AgO}$  content of commercial product 97.5%, is now known to have the formula  $\text{Ag}^I\text{Ag}^{II}\text{O}_2$ . It is a gray-black powder, with a monoclinic crystal structure, which decomposes slowly to the elements above ca. 85 °C and rapidly above 100 °C. Silver(I) oxide has not been detected as an intermediate of this reaction.

Silver(II) oxide is usually prepared by the oxidation of monovalent or elemental silver by peroxodisulfate [94]. Other suitable oxidizing agents are potassium permanganate, ozone, sodium hypochlorite, or an electric current. Silver(II) oxide is a strong oxidizing agent. In contact with organic compounds, including solvents, spontaneous reaction can occur. It is increasingly used in voltaic cells, where the amount of electricity produced per mole of silver(II) oxide reacted is twice that produced per mole of silver(I) oxide, leading to economies in weight and space. The lower silver consumption means it is often more economical to use silver(II) oxide than silver(I) oxide, despite higher production costs.

#### 24.7.4 Other Soluble Silver Compounds

**Silver sulfate**,  $\text{Ag}_2\text{SO}_4$ , silver content 34.60%,  $mp$  657 °C,  $\rho$  5.45 g/cm<sup>3</sup>, is a white, crystalline salt with rhombic structure. It is fairly soluble in water (Figure 24.8) and more soluble in sulfuric acid (Figure 24.1), forming  $\text{AgHSO}_4$ , which can be isolated. Silver sulfate is produced by the reaction of silver with hot, concentrated sulfuric acid.

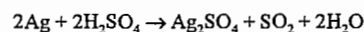

It can also be prepared by precipitation with sulfuric acid from  $\text{AgNO}_3$  solution, followed by recrystallization from dilute sulfuric acid.

**Silver permanganate**,  $\text{AgMnO}_4$ , silver content 47.60%, is a black-violet salt that is moderately soluble in water (Figure 24.8). It can be used as a disinfectant and oxidizing agent. It is produced as the least soluble component in the system

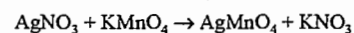

or by the reaction of silver(I) oxide or silver carbonate with a solution of permanganic acid.

**Silver(I) fluoride**,  $\text{AgF}$ , silver content 87.79%,  $mp$  434 °C,  $\rho$  5.852 g/cm<sup>3</sup>, is a white, flaky, crystalline solid with cubic crystal structure. It is hygroscopic and soluble in water. With increasing temperature, the solid

phases  $\text{AgF} \cdot 4\text{H}_2\text{O}$  and  $\text{AgF} \cdot 2\text{H}_2\text{O}$  exist in equilibrium with the saturated solutions.

Silver fluoride is prepared by the reaction of silver(I) oxide or silver carbonate with hydrofluoric acid, or by dissolving finely divided precipitated silver powder in hydrofluoric acid and hydrogen peroxide.

Silver fluoride is of minor industrial importance but is used in preparative fluorine chemistry.

Disilver fluoride,  $\text{Ag}_2\text{F}$ , is water sensitive, and silver(II) fluoride,  $\text{AgF}_2$ , is highly reactive.

**Silver tetrafluoroborate**,  $\text{Ag}[\text{BF}_4]$ , is used in aqueous solution as an absorbent for ethylene. It can be produced in benzene

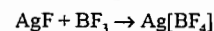

or in aqueous solution

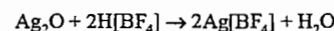

The compound is very hygroscopic and unstable to light.

**Oxy Salts of Halogens.** Silver chlorate,  $\text{AgClO}_3$ , is moderately soluble in water, and silver perchlorate,  $\text{AgClO}_4$ , is very soluble.

**Soluble Organic Silver Compounds.** Silver(I) acetate (Figure 24.8), silver(I) propionate, and silver(I) lactate are fairly soluble in water.

#### 24.7.5 Other Insoluble Silver Compounds

**Silver sulfide**,  $\text{Ag}_2\text{S}$ ,  $mp$  845 °C,  $\rho$  7.326 g/cm<sup>3</sup>, silver content 87.06%, forms black crystals or powders with monoclinic crystal structure (as argentite, cubic), and is the least soluble silver compound ( $7 \times 10^{-14}$  g/L at 20 °C). It is not dissolved by the ligands ammonia and thiosulfate, but is dissolved by cyanide. Silver sulfide can be dissolved by oxidative reactions (e.g., in hot, concentrated nitric acid). It can be reduced by base metals or by dithionite in alkaline solution. The latter is used to remove the dark coating from tarnished silver. Silver sulfide is prepared from the elements at 250–400 °C or by precipitation of silver by sulfide ions.

**Silver carbonate**,  $\text{Ag}_2\text{CO}_3$ ,  $\rho$  6.077 g/cm<sup>3</sup>, is a white powder that rapidly turns yellow. It has a monoclinic crystal structure and decomposes at 218 °C, liberating carbon dioxide. It is prepared from soluble silver compounds by precipitation with alkali-metal carbonate.

**Silver isocyanate**,  $\text{AgNCO}$ , can be precipitated from aqueous solution. A mainly covalent Ag–N bond is present in  $\text{AgNCO}$ . Silver cyanate,  $\text{AgOCN}$ , apparently does not exist. Unlike the isomeric silver fulminate,  $\text{AgCNO}$  (see Section 24.7.7), silver isocyanate is thermally stable. The nomenclature for cyanates and isocyanates is, however, not yet uniform [19, 95–97].

**Silver cyanide**,  $\text{AgCN}$ ,  $mp$  350 °C,  $\rho$  4.62 g/cm<sup>3</sup>, is a white powder with a trigonal crystal structure. It is prepared from soluble silver salts by precipitation with cyanide anions. This compound is the precursor in the production of potassium dicyanoargentate(I). Silver cyanide used to be important in analytical chemistry because of its low solubility in water, and the ease and rapidity with which it can be converted into the dicyanoargentate complex.

**Silver thiocyanate**,  $\text{AgSCN}$ ,  $\rho$  3.746 g/cm<sup>3</sup>, is a white powder with a monoclinic crystal structure that decomposes on melting. It is produced by precipitation from aqueous solution, a reaction that is also used in quantitative analysis.

#### 24.7.6 Silver Complexes

**Potassium dicyanoargentate(I)**,  $\text{K}[\text{Ag}(\text{CN})_2]$ , silver content 54.20%,  $\rho$  2.364 g/cm<sup>3</sup>, forms white crystals with trigonal structure, which are very soluble in water (Figure 24.8) and fairly soluble in ethanol. It is prepared by dissolving silver cyanide in an aqueous solution of KCN, concentrating by evaporation, and crystallizing. It can also be obtained electrolytically by the anodic oxidation of silver in aqueous potassium cyanide solution. This method is analogous to that for the preparation of  $\text{K}[\text{Au}(\text{CN})_2]$ . Potassium dicyanoargentate is the basis of cyanide plating baths and is

used extensively in the jewelry industry. The corresponding sodium salt has similar properties and is an intermediate in the extraction of silver from ores by the cyanide process.

**Thiosulfate Complexes.** Several complexes are known, for example,

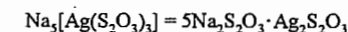
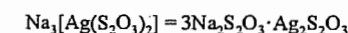
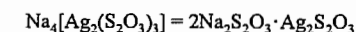
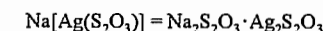

All these take part in the photographic fixing process (see Section 24.9.9) but have no technical importance in their own right. Their solubility in water increases as the ratio of  $\text{S}_2\text{O}_3^{2-}$  to silver in the complex increases.

**Diammine Complexes.** The cationic complex  $[\text{Ag}(\text{NH}_3)_2]^+$  is formed when most silver compounds are dissolved in aqueous ammonia. The solution is unstable and can precipitate highly explosive fulminating silver.

#### 24.7.7 Explosive Silver Compounds [98]

Many unstable silver compounds are known whose decomposition can occur spontaneously and explosively. This reaction is usually initiated by heat, pressure, impact, or abrasion. These unstable silver compounds are all light sensitive. Hence, high-energy flashes of light can also occasionally cause explosive decomposition. Such compounds are no longer used to any extent, or are used only for very special preparative work, partly because of the near impossibility of storing them safely. Nevertheless, they can be formed in many chemical reactions and processes and, if their existence and properties are unrecognized, can result in accidents.

**Silver azide**,  $\text{AgN}_3$ , silver content 71.97%, has colorless, needle-like crystals ( $mp$  252 °C). It is an extremely explosive compound, sensitive to heat, impact, and pressure.

Silver azide is insoluble in water and can be obtained by precipitation from solutions of sodium azide and silver nitrate. It can be used to

prepare the equally explosive iodine azide ( $\text{IN}_3$ ):

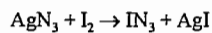

It is less stable than lead azide and has therefore not been used as a detonator.

**Fulminating silver** forms black crystals that consist of a mixture of silver nitride,  $\text{Ag}_3\text{N}$ , and silver imide,  $\text{Ag}_2\text{NH}$ . It is formed when aqueous ammoniacal solutions of silver compounds are stored, and by the action of ammonia on silver oxide or silver carbonate.

An explosion can be caused by slight movement of a vessel containing an aqueous solution in which a small amount of fulminating silver has precipitated and collected at the bottom. Aqueous solutions containing  $[\text{Ag}(\text{NH}_3)_2]^+$  should therefore never be stored.

**Silver amide**,  $\text{AgNH}_2$ , is highly explosive. It is formed mainly by the reaction of silver compounds with liquid ammonia. Silver fittings or equipment should therefore not be used in contact with liquid ammonia.

**Silver fulminate**,  $\text{AgCNO}$ , is the silver salt of fulminic acid,  $\text{HCNO}$  [95, 99], and is sometimes also referred to as fulminating silver (see above). It forms white needles that explode under mechanical or thermal stress, and is considerably less stable than mercury fulminate.

**Silver acetylide**,  $\text{Ag}_2\text{C}_2$ , is an amorphous compound that decomposes explosively on impact or heating. On treatment with alkali-metal hydroxides, hydrolytic decomposition takes place.

Silver acetylide is prepared by passing acetylene into an ammoniacal solution of silver salts. If acetylene is passed into a neutral solution of silver nitrate, crystalline addition compounds, such as  $\text{Ag}_2\text{C}_2 \cdot \text{AgNO}_3$  or  $\text{Ag}_2\text{C}_2 \cdot 6\text{AgNO}_3$ , are precipitated. Explosive silver acetylide is also formed when silver compounds come in contact with an acetylene flame. The existence of this hazard is the reason acetylene flames are not used for the exci-

tation of silver in solution for spectral analysis. Apparatus and containers for acetylene should not include fittings or components made of silver or high-silver alloys. Conventional silver brazing alloys are safe.

**Silver oxalate**,  $(\text{COOAg})_2$ , is a white compound that is insoluble in water and can be prepared by precipitation. It is temperature sensitive and decomposes on gradual heating, but detonates if heated rapidly.

## 24.8 Disperse Silver [18, 19, 56, 99]

### 24.8.1 Silver Powder

Silver powder is classified as microcrystalline, spheroidal, or lamellar (flakes and bronzes), according to its particle shape. All three types, which differ in method of manufacture, have specific areas of use. The basic material is pure silver or combinations of silver and palladium.

For various applications, the following properties are important: bulk density, tapped density, and tamped density (Table 24.7), sinterability, flow properties, densities achievable by compression and sintering, specific surface area, and content of impurities such as  $\text{Na}^+$ ,  $\text{K}^+$ , and  $\text{Cu}^{2+}$ . These properties depend ultimately on particle shape and size, and on particle-size distribution. The size of the primary particles is not identical to the particle size measured by particle-size analysis, especially for dendritic powders in which agglomerates often occur. Earlier quality specifications were based mainly on sieve analysis, which has now largely been replaced by laser granulometry. The latter gives a value for particle size such that a defined fraction of the material (e.g., 90%) is finer than the quoted particle size. Methods for particle-size analysis are being supplemented more and more by optical and scanning electron microscopy.

Table 24.7: Silver powder (physical properties, old system).

Origin	Production method	Particle shape	Bulk density, g/cm <sup>3</sup>	Specific surface area (BET), m <sup>2</sup> /g	Sinterability	Flow properties	Sieve analysis
Degussa	chemical precipitation	crystalline (isometric)	ca. 12	ca. 10	good	poor	< 32 μm ca. 90% 32–40 μm ca. 10% 40–60 μm ca. 1% 60–75 μm 0.1% 75–100 μm ca. 0.1% > 100 μm ca. 0.1%
	electrolysis of acidic electrolytes	crystalline (isometric) dendritic	ca. 1.6	ca. 0.8	good	fair	< 32 μm ca. 70% 32–40 μm ca. 20% 40–60 μm ca. 10% 60–75 μm 1% 75–100 μm ca. 0% > 100 μm ca. 0%
	cementation	crystalline (dendritic)	ca. 1.5	ca. 0.3	good	fair	< 32 μm ca. 50% 32–40 μm ca. 20% 40–60 μm ca. 20% 60–75 μm 5% 75–100 μm ca. 5% > 100 μm ca. 3%
	atomization	spheroidal	ca. 4.2	ca. 0.06	poor	good	< 32 μm ca. 50% 32–40 μm ca. 30% 40–60 μm ca. 20% 60–75 μm 1% 75–100 μm ca. 1% > 100 μm ca. 0%

Table 24.8: Silver powder and flakes (physical properties, new system).

Producer	Product no.	Particle shape	Tapped density, g/cm <sup>3</sup> <sup>a</sup>	BET surface, m <sup>2</sup> /g	Particle size <sup>b</sup> , μm	Impurities, ppm		
						Na <sup>+</sup>	K <sup>+</sup>	Cu <sup>+</sup>
Demetron	309	microcrystalline	1.2–1.6	0.5–0.9	< 19	< 100	< 10	< 500
	328	microcrystalline	1.0–1.6	1.2–1.7	< 19	< 100	< 10	< 10
	331	microcrystalline	2.8–3.8	0.7–1.2	< 10	< 10	< 10	< 10
	F 14	flakes	2.1–3.2	0.7–1.1	< 32	< 20	< 10	< 500
	D 12	flakes	2.5–3.1	1.0–1.5	< 20	< 30	< 10	< 500
	D 25	flakes	3.0–4.0	1.2–1.8	< 16	< 150	< 10	< 10
	D 27	flakes	3.3–4.3	1.0–1.8	< 16	< 100	< 10	< 10
Metz	D 35	flakes	3.0–4.0	1.0–1.5	< 18	< 10	< 10	< 10
	Q-100	microcrystalline	0.9–2.0	0.55–1.05	< 18	< 25	< 10	0 20
	C-200 ED	microcrystalline	2.6–4.2	0.5–0.9	< 8	< 50	< 30	< 30
	EG 200	microcrystalline	1.5–3.0	0.15–0.4	< 13	< 125	< 10	< 30
	9	flakes	2.6–3.5	0.9–1.2	< 11	< 150	< 200	< 350
	15	flakes	2.8–4.0	0.6–1.2	< 10	< 50	< 10	< 30
	25	flakes	3.35–4.3	0.35–0.75	< 22	< 30	< 30	< 30
52	flakes	3.6–4.65	0.4–0.7	< 14	< 30	< 30	< 30	

<sup>a</sup> ASTM 527-85.

<sup>b</sup> Typical particle size distribution by laser granulometry; Demetron, 84% smaller than stated particle size; Metz, 90% smaller than stated particle size.

**Microcrystalline Silver Powder.** Several basic types of microcrystalline silver powder are available, differing in method of preparation, type of particle, and properties (Table 24.8). They were used almost entirely in sintering technology for a long time. Today, they are also used in stoving preparations (e.g., metal-

lization of ceramics) and in pastes for repairing heated rear windows of motor vehicles.

The most important method of production is precipitation by reducing agents, such as formaldehyde, potassium sodium tartrate, and hydrazine, from solutions of silver nitrate in dilute sodium hydroxide solution. Alterna-

tively,  $\text{Ag}_2\text{O}$  or  $\text{Ag}_2\text{CO}_3$  suspensions are sometimes reduced with these reducing agents.

Cementation with less noble metals is no longer of practical importance because of contamination of silver with the precipitating metal and wastewater problems.

Electrolytic reduction of silver nitrate solutions under conditions used in Möbius electrolysis leads to a coarsely crystalline product that is not generally regarded as a silver powder and is marketed as "crystal silver". However, by using special methods of scraping or washing the cathode and varying the conditions, the electrolysis of silver nitrate can be made to yield a finely powdered material suitable for sintering applications. Electrolysis of an acidic medium has the advantage that base metals are not usually deposited with the silver. This allows less pure starting materials to be used [100]. Cathodic reduction of semiconducting silver(I) oxide in a medium containing sodium hydroxide leads to finely divided silver powder that is very similar to the chemically precipitated product. Silver oxide can be obtained by precipitation or by oxidation of a silver anode and deposition of the oxide on the cathode. Also, thermal decomposition of silver(I) oxide or silver carbonate gives a silver powder with a relatively small specific surface area.

**Spheroidal Silver Powder.** Atomization of molten silver by compressed air, inert gas, a water jet, or a rapidly rotating knife produces spheroidal silver powder, which is used mainly in sintering technology. It is character-

ized by relatively high bulk density, low specific surface area, and good flow properties.

**Flakes and Bronzes.** Lamellar particles are obtained by ball milling microcrystalline silver powder. Flakes and bronzes are incorporated into paints and adhesives, where they impart electrical conductivity to the polymer matrix due to the good particle-to-particle electrical contact.

**Silver-palladium powder** is used in the production of conducting electrodes in ceramic multilayer capacitors. Palladium improves the migration resistance. Several types of powder are produced by different methods, including mixtures of silver and palladium powders (composite blends), simultaneously precipitated Ag-Pd powders (coprecipitates), and alloy powders (solid solutions). Examples of these stoving powders are given in Table 24.9.

#### 24.8.2 Colloidal Silver [2, 19, 84, 101]

Like most noble metals, silver forms very stable colloidal solutions in water.

Properties typical of colloids are observed mainly for the particle-size range 0.001–0.1  $\mu\text{m}$ . Fine-grained photographic emulsions can also consist of dispersions of colloidal dimensions. Most commercial silver colloids have an average particle size between 0.01 and 0.05  $\mu\text{m}$ , corresponding to specific surface areas between 50 and 250  $\text{m}^2/\text{g}$  silver. The use of silver sols in medicine and for the disinfection of water on the high reactivity of silver resulting from its large surface area.

Table 24.9: Silver-palladium powders for multilayer capacitors.

Producer	Product no.	Composition, %	Particle shape	Tapped density, $\text{g}/\text{cm}^3$	Particle size, $\mu\text{m}$	Specific surface area, $\text{m}^2/\text{g}$
Demetron	6427 1202	Ag 70 Pd 30	spheroidal	1.4	< 30	3.0
	6427 1102	Ag 80 Pd 20	spheroidal	0.6	< 12	3.6
	6437 0401	Ag 80 Pd 20	flakes	3.2	< 8	2.2
	6437 2401	Ag 70 Pd 30	flakes	3.4	< 7	3.6
	6437 0501	Ag 60 Pd 40	flakes	2.6	< 8	1.6
Metz	5030-1	Ag 70 Pd 30	spheroidal	1.2–2.2	< 5	1.5–2.4
	5070	Ag 30 Pd 70	spheroidal	1.5–3.0	< 5	1.5–4.0
	3030-1	Ag 70 Pd 30	spheroidal	2.1–3.2	< 2.6	1.2–2.4
	3030 flake	Ag 70 Pd 30	flakes	2.7–4.6	< 6.5	1.5–2.2
	3070	Ag 30 Pd 70	spheroidal	1.5–2.3	< 3.5	1.9–3.0

As with all colloidal solutions of metals in water, the stability of the solution is maintained by the negative charge on the metal particles and their consequent mutual repulsion. The negative charge is caused by the adsorption of anions. If it is disturbed by aging or by the adsorption of electrolytes until the isoelectric point is reached, partial or complete coagulation and flocculation occur.

Aging and the effects of electrolytes can be inhibited by adding protective colloids, generally naturally occurring polymers. These can still be effective after the dispersant has evaporated, allowing the powder left behind to produce a colloidal solution on rewetting. Such reversible colloids are often preferred to colloidal solutions because of ease of handling.

Colloidal silver is generally produced by reduction of a dilute solution of silver nitrate by the usual reducing agents (e.g., formaldehyde, hydrazine) at elevated temperature. Polymers that behave both as protective colloids and contain reducing groups can also be used [102]. A silver sol can also be produced by the electrical dispersion of compact metallic silver immersed in water. Commercial silver sols usually have concentrations of ca. 1% silver. Their color by transmitted light varies between yellow and brown, and they show green to blue fluorescence effects by reflected light. Colloidal silver powder, which is black and granular, has a silver content varying between 75 and 97%. On redispersion in water, dark brown to black colors are obtained.

## 24.9 Uses [103]

### 24.9.1 Coins [1, 2, 6, 104]

The amount of coinage in circulation has undergone with fluctuations throughout the course of history. The interchange between the monetary and functional use of silver has often been influenced by the political situation. In times of war, silver was monetized to a greater extent to pay the costs, and when prosperity was restored, the metal returned to private possession in the form of silver articles.

Since the growth of the industrial demand for silver, it has become demonetized. Nevertheless, large quantities of silver coins, withdrawn from circulation, are still used as national reserves. Even today, in some countries, small coins and banknotes are backed up by actual quantities of silver. In Germany, the circulation of silver coins reached a high point in 1880 before the introduction of paper money.

In ancient times, silver coins were minted from refined silver (980/1000 to 990/1000), especially in Athens and Rome. The coins of the Middle Ages usually have a fineness between 900/1000 and 990/1000. The actual value of these coins matched their face value. However, in periods of coinage debasement, so-called token coins also existed, whose metal value was less than their face value, and in which the silver content was reduced to ca. 500/1000. In the 1900s, token coins were minted generally. The silver content fluctuates between 945/1000 and 400/1000.

The technique of minting silver coins has undergone many changes over time. At first, silver coins were produced partly by casting and partly by means of a hammered die. Various designs of press were then used. Today, rods or ingots are first produced by continuous casting. The ingots or rods are rolled to form plates of the exact thickness for coinage production. These plates are then heat treated to remove the effects of cold work hardening. Blanks are then cut or punched out from the plates, which are then blanched (whitened) by dipping in dilute sulfuric acid to dissolve both the thin oxide layer and the copper near the surface of the metal. This gives a lighter surface color and a pure silver appearance. After being washed, the coin blanks are dried in centrifuges, the edges are knurled in milling or crimping machines, and the edge lettering is added, this is followed by minting in a coining press or coining machine. Modern minting machines produce 8000 coins per hour.



### 24.9.2 Jewelry [18, 23]

In earlier times, the manufacture of silver articles for jewelry and general use was the main outlet for silver, apart from coinage manufacture, and it is still very important. The category includes table silver such as cutlery, jugs, dishes, plates, and cups, as well as goblets, trophies, cases, church silverware, vases, lamps, and articles of jewelry such as necklaces, bracelets, broaches, pendants, and rings. Silver is also used in the fabrication of musical instruments, especially flutes. Apart from its investment and display aspects, the bactericidal action of silver has always been an important aspect of the purchase and use of silver tableware articles (see Section 24.12.2).

Today, silver-copper alloys with finenesses of 925/1000, 835/1000, and 800/1000 are used in all forms of jewelry because of their favorable properties for both manufacture and use [105, 106]. Whereas fineness is now marked in thousandths, the earlier system used "Lot" units. Fineness was also expressed in the Russian solotnik system.

The standard materials, Ag925, Ag835, and Ag800 are supplied in the form of sheets, bands, wires, rods, and profiles. The industrial process of alloy production in a vacuum oven followed by casting and cold forming has now been replaced almost entirely by continuous casting. The quality of the alloys has thereby been improved, especially with respect to homogeneity, shrinkage, gas cavities, and formability.

*Tarnishing of silver* is a result of the formation of silver sulfide caused by the action of hydrogen sulfide and its organic or inorganic derivatives. Incorporation of gold, platinum, or palladium into the alloy improves tarnish resistance but is expensive. Base-metal alloy components such as zinc and cadmium change the color and luster without preventing tarnishing completely. Electrolytic pure silver coatings are more resistant to tarnishing than the usual silver copper alloys. Rhodium coatings, which were sometimes used in the past, are expensive and alter the appearance, albeit only slightly. Colorless coatings (e.g., lac-

quers) also spoil the appearance of the silver surface.

Dipping baths for removing the tarnished layer reduce silver sulfide to fine silver, which washes off without affecting appearance. Pastes are also used that contain extremely fine abrasives and reducing agents such as sodium dithionite. Surface-active additives, usually silicone based, give some extended protection. The tarnishing of cutlery, in particular, can be prevented by wrapping it in a cloth impregnated with finely divided elemental silver. These cloths absorb sulfidic compounds from the air so that they cannot react with the compact metal surface. The most effective method of treatment, however, is still the laborious process of cleaning with a paste, which removes not only the surface layer of silver sulfide but also small surface imperfections, giving a smooth polish and restoring the original luster and warm color of the silver.

*Coloring.* The only important coloring processes are blanching with sulfuric acid and forming oxidized silver, which is a type of partial tarnishing.

### 24.9.3 Medicine [1, 2, 18, 22, 23]

Silver compounds are used only sporadically in internal medical therapy, although they were more widely used in earlier times for the treatment of epilepsy and gastric ulcers. Today, their main use is for their bactericidal action on certain pathogens. Here, they behave similarly to mercury compounds but are less toxic. Several complex compounds of silver that can be absorbed through the mucous membranes are used, mainly for disinfection of the throat. The use of very dilute solutions of silver nitrate was for a long time a legally prescribed prophylactic treatment against possible streptococcal infection of the mucous membrane of the eyes of newborn babies in Germany. Silver nitrate is a component of Fisan silver powder for the treatment of surface wounds. The local caustic effect of silver nitrate can be used to destroy proliferating tissue. A protective layer of silver chloride and silver albuminate is formed by reaction with

the skin, limiting the extent of the caustic effect which is also associated with an antiseptic and astringent action. Sulfadiazine silver(I) [AgSD, 2-sulfanilamidopyrimidine silver(I)]

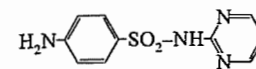

is used as a bacteriostatic compound in the treatment of life-threatening burns [103, 107].

Colloidal silver sols have similar bactericidal properties due to the oligodynamic action of silver. They are used in the form of stabilized solutions for disinfecting wounds, as are colloidal sols of sparingly soluble silver compounds.

Silver and silver alloys have long been used as bone replacements, mainly in cranial surgery. Also, silver wire is used in suturing connective tissue, and fine silver gauze is used as an implant. Here, too, the oligodynamic properties of silver are beneficial. It was once common to place silver foil or even silver coins on wounds for the same reason.

### 24.9.4 Dentistry [18, 22, 23, 56]

Silver-tin amalgams are used in dentistry to fill tooth cavities. The preferred alloys contain  $\geq 40\%$  silver,  $\leq 32\%$  tin, 30% copper, 2% zinc, and 3% mercury. They are produced initially in the form of cast blocks, which are then powdered by machining or converted to small spheroidal particles by atomization. The dentist mixes this alloy powder with an approximately equal weight of mercury to give a stiff paste. This paste is pressed carefully into the tooth cavity, the liquid mercury acting as a lubricant. Hardening is complete after a few hours and is accompanied by a small volume increase. In the older types of alloy, the important metallic phases present before hardening started were  $\text{Ag}_3\text{Sn}$ , Sn, and Hg. During hardening, the  $\text{Ag}_3\text{Sn}$   $\gamma$ -phase, which is the main component of the powdered amalgam, reacts with mercury to form a solid phase  $\text{Ag}_3\text{Hg}_4$  ( $\gamma_1$ ), and a solid Sn-Hg mixed-crystal phase  $\text{Sn}_8\text{Hg}$  ( $\gamma_2$ ). The reactions are incomplete be-

cause the amount of mercury is insufficient. Some  $\text{Ag}_3\text{Sn}$  ( $\gamma$ ) always remains in excess.

Because of the presence of the relatively base metal tin, the  $\gamma_2$ -phase is the weakest component of a filling with respect to both corrosion and mechanical properties. Formation of the  $\gamma_2$ -phase can be suppressed by increasing the copper content and decreasing tin. Such formulations are known as non-gamma-2 amalgams. Despite advances in polymer-based filling materials whose color matches that of the tooth, non-gamma-2 amalgams have continued to fulfill an important function in the treatment to back teeth where biting forces are greater.

Silver-containing alloys are also used in dental prostheses. The gold-colored (gold-based) noble-metal alloys contain some palladium or platinum and ca. 10–15% silver, and the white noble-metal alloys based on silver palladium contain up to 65% silver.

### 24.9.5 Silver Plating [18, 23, 108, 109]

**Silver Electroplating** [110, 111]. Electrolytic deposition is the most important process for producing silver coatings. The electrolytes used are alkaline baths of potassium dicyanoargentate(I) containing an excess of potassium cyanide, with potassium carbonate as the conducting salt. Soluble pure silver anodes replace the metal deposited from the electrolyte onto the cathode. For plating articles in daily use, the preferred substrate is German silver (45–70% Cu, 5–30% Ni, 8–45% Zn), which combines good mechanical properties with good adhesion to the silver coating. Copper and nickel can also be electroplated directly. A thin initial silver coating (strike), produced in a special bath, often increases adhesion considerably. When electroplating iron, an intermediate coating of copper or nickel is necessary. Articles made of plastic (mainly acrylonitrile-butadiene-styrene and polyurethane) or ceramic can be electroplated with silver if the surface is first provided with an electrically conducting coating by the electrodeless deposition of copper or nickel.

The luster of silver coatings can be improved by additions of xanthates or thiourea to the plating bath. Their hardness can be influenced by doping the bath with antimony, bismuth, arsenic, selenium, or lead [112]. Highly abrasion-resistant coatings, so-called dispersion coatings, are produced by dispersing ceramic materials in the electrolyte during deposition.

Coatings having different thicknesses at different parts of a workpiece can be produced by using special anodes that match the geometric shape of the workpiece and by controlling the electric field in the electrolyte with the aid of masks. This technique can be used, for example, to produce thicker deposits on cutlery at places where increased wear is expected.

Silver electroplating is used mainly in the cutlery, jewelry, and electronics industries. In total, considerably more silver is used in the manufacture of electroplated cutlery than for solid silver cutlery. The potassium dicyanoargentate(I) used in the process is the silver compound produced in greatest quantity after silver nitrate and silver(I) oxide. The quality of silver plating on cutlery is quoted in grams of silver per dozen table settings consisting of three items per setting. For the usual qualities, 60, 90, or 100 minimum coating thicknesses are specified (e.g., 36  $\mu\text{m}$  for a 90-g silver plating) [109, 113]. For jewelry, coatings are considerably thinner (e.g., 5–10  $\mu\text{m}$ ). In electronics, thicknesses of a few micrometers are often sufficient.

The deposition of silver alloys usually leads to heterogeneous coatings with inferior technical properties, although significant improvements have been obtained using gold-colored Au–Cu–Ag alloy coatings, in which silver is used in place of cadmium to lighten the color [56].

Silver electroplating is carried out in batch or continuous equipment and by barrel plating. Wire-plating plants are also operated. In some cases, partial silver plating is carried by brush plating, in which the anode and cathode are linked by a pad soaked in electrolyte.

In bulk production, continuous-flow plating plants are widely used, especially in the production of electronic components [56]. As with electroforming, their importance for gold is greater than for silver.

**Silver Plating by Chemical Reactions** [2, 18, 108]. Deposition of silver from aqueous solutions of silver salts onto workpieces of base metals normally leads to silver coatings of inadequate quality. However, by using a solution of  $\text{K}[\text{Ag}(\text{CN})_2]$ , a fairly adherent—although very thin ( $< 1 \mu\text{m}$ ) and somewhat porous—coating can be deposited on copper by this simple method. The process is known as cementation plating.

The deposition of silver can be accelerated by contacting the metal to be plated with aluminum or zinc (contact silver plating). This plating process gives thicker, pore-free silver coatings. Contact silver plating is carried out in hot cyanide electrolytes. It is very economical for mass-produced articles, but has declined in importance.

Instead of base metals, chemical reducing agents can be added to the cyanide electrolytes [e.g., sodium hypophosphite ( $\text{NaH}_2\text{PO}_2$ ), sodium borohydride, hydroquinone, or hydrazine hydrate]. The cementation reaction with the substrate metal also takes place to some extent. This plating process is improved by the addition of complexing agents such as ethylenediaminetetraacetic acid. Plastics and ceramics can also be plated by an electroless method after activating pretreatment with tin(II) chloride and palladium(II) chloride solution.

Silvering of glass, mainly for mirrors, Christmas tree decorations, and vacuum flasks, is performed with an ammoniacal silver nitrate solution to which a solution of formaldehyde and sodium hydroxide is added as reducing agent [2, 114]. Silver is deposited on the surface of the glass, usually on warming. This reduction reaction is also used in spray silvering, in which the two solutions are applied through the separate nozzles of a spray gun.

Friction plating consists of rubbing a workpiece with a moist mixture of very fine silver powder, silver chloride, and a reducing agent. This process was formerly used for silvering clock faces.

Titanium articles can be silver plated by dipping into molten silver chloride. This produces a coating of silver that adheres well but is not entirely free of pores [115].

**Mechanical and Thermomechanical Plating** [18]. Mechanical plating processes are often used to produce thick silver coatings, mainly for chemical apparatus, heavy-current contacts, and coating composite semifinished products.

In roll cladding, silver is bonded to the base metal at a very thin boundary region where the two metallic crystal lattices become interlocked. Cold and hot roll cladding can be carried out.

In solder plating, a silver brazing alloy is introduced between the two surfaces to be joined, and the melting point is exceeded by a definite amount on compressing the heated metal sheets. In some systems (e.g., silver-copper), a solder-like bond is produced if the melting point of the eutectic mixture of the two metals is exceeded in the boundary region. This process is known as hot press welding or eutectic welding.

Other plating processes that can be used with silver include cold press welding, atomic hydrogen arc welding, and explosive cladding.

**Vapor-Phase Processes.** As with the other noble metals, vacuum vaporization of silver can be achieved by cathodic sputtering or ion plating. These processes are used mainly to produce very thin films (e.g., for microelectronics).

**Firing Processes** [18]. Ceramic articles (e.g., porcelain tableware and industrial porcelain components) and glass can be silvered by melting pasty silver-containing preparations. The resulting coatings can be soldered, polished if they are sufficiently thick (1–10  $\mu\text{m}$ ), or used as a basis for further electroplating.

The pastes consist of suspensions of very fine silver powder or organic silver compounds with powdered glass in essential oils. Heating must be carried out with addition of air to burn off the organic components completely, preferably at 550–800 °C. Electronic components are often selectively silver plated by screen printing. In the mass production of glasses and porcelain tableware, decorative patterns are applied by transfer processes.

## 24.9.6 Electrical Technology

See references [2, 18, 22, 23, 116]. Silver is used in electrical technology because of its good oxidation resistance and high electrical and thermal conductivity. Pure silver; silver-copper and silver-nickel alloys; the composite metals Ag–Ni, Ag–W, Ag–Mo; and the composite materials Ag–CdO, Ag–SnO<sub>2</sub>, Ag-graphite, and Ag–WC are used (Table 24.10).

In heavy-current technology, silver is used mainly as the contact material in switches [117–120]. The loss of metal due to arcing is considerably less with pure silver than with copper contacts. Even better results are obtained with silver alloys or composite materials based on silver. These materials cause the interruption arc to be extinguished more rapidly. Their high-temperature stability under pressure is greater, which also reduces the danger of welding. Electrical conductivities and often frictional properties are important in selecting the most suitable material. Some of the materials used are listed in Table 24.10. In preference to alloys, composite metals are used, which consist of sintered bodies made of two metals that do not form alloys to an appreciable extent. Composites that include nonmetallic components are also employed. Today, ecological as well as purely technological considerations are important, so that, for example, the Ag–CdO system has been replaced by Ag–SnO<sub>2</sub>, which is nontoxic and has better resistance to burning off. The composite materials are usually produced from mixtures of the components by powder metallurgy or they can sometimes be obtained by coprecipitation followed by thermal treatment.

Table 24.10: Silver-based materials for electrical contacts.

Compositions, %										Electrical conductivity*	Characteristic properties	Uses
Ag	Cu	Cd	Ni	CdO	C	SnO <sub>2</sub>	W	Mo	WC			
<b>Alloys</b>												
99.9										104	tendency to weld	low-current contacts (wide use)
92.5 705										88	higher mechanical strength and lower welding tendency than fine silver	relay contacts
90 10										88		
72 28										84		
85 15										35	reduced welding tendency	fuses (early type)
77 22.6										31		
<b>Composite metals</b>												
95 5										95	resistant to electrode burning; formable and claddable	mechanically and thermally stressed (domestic equipment)
90 10										87		
85 15										80		
70 30										55		
60 40										44		
40 60										25		
90										92	resistant to electrode burning; large contacting forces needed	heavy-current switching
50										62		
35										51		
50										52	similar to Ag-W; somewhat less resistant to electrode burning	heavy-current switching
40										47		
<b>Composite materials</b>												
97.5 2.5										88	very resistant to welding; intermediate coating needed for soldering	fuses
95 5										84		
90 10										75		
85 15										65		
99.5 0.5										102	extremely resistant to welding; brittle; severe electrode burning	low-voltage, heavy-current switching; sliding contacts
99 1										99		
98 2										77		
95 5										55		
90 10										35		
95 5											slightly susceptible to welding	open fuses (air break contactors)
92 8												
88 12												
65										57	resistant to electrode burning; very resistant to welding; difficult to work	heavy-current fuses
50										47		
40										37		

\*Copper = 100.

For example, the composite system Ag-CdO can be produced by internal oxidation of the cadmium in an Ag-Cd alloy. In the case of molybdenum and tungsten, silver can be absorbed into a matrix of these refractory metals.

The important components in low-current technology are contact breakers (relays), sliding contacts, plug and socket connectors, soldered joints, and screw connectors. The requirements for these contact materials are different from those for heavy-current technology. These include low contact resistance,

resistance to effects of the atmosphere, and good abrasion resistance. A good connection must be obtained even after a large number of switching operations. In low-current technology, silver alloys are generally used in preference to expensive composite materials. These are deposited on the contacts as very thin films. In telephone relays, so-called reed contacts, based on Ag-Pd, are used.

In microelectronics, silver coatings on system carriers often facilitate both good contacting behavior and good solderability. Silver,

silver-palladium, and silver-platinum pastes are deposited as thick films on Al<sub>2</sub>O<sub>3</sub> substrates to provide the conducting paths in switching circuits. Conductive adhesives with silver powder as the filler are used increasingly to give good electrical contact with semiconductor crystals and other electronic components and circuits.

For fuses, silver-coated copper wires are preferred because they do not oxidize even after prolonged heating, and their resistance therefore remains constant. So-called superquick-acting fuses for protecting semiconductor components are made of silver wires with a defined reduction in cross section at certain points.

Silver compounds are used in the construction of electric batteries. Silver(I) oxide is used in button cells for general electronic equipment. Silver(II) oxide, which has a higher capacity owing to divalent silver, is increasingly being used in button cells in both space and military applications. The AgCl-Zn combination is employed in emergency batteries used at sea. These start to operate automatically on contact with seawater.

#### 24.9.7 Chemical Equipment [18, 121-124]

Silver is a very useful, although expensive, material of construction in the chemical industry, having good chemical resistance, high thermal conductivity, and good mechanical and working properties.

In the chemical laboratory, silver crucibles are used mainly for alkaline fusion [123]. The presence of ca. 0.15% nickel in the alloy prevents recrystallization on heating to red heat, which can lead to a coarse and brittle metal structure. In preparative fluorine chemistry, silver, as well as copper, is often used for equipment parts [84].

Silver-plated articles are used in chemical process technology. These include vessels, autoclaves, pipework, heat exchangers, and sometimes small fittings. Equipment made of massive silver is uncommon, but is used for concentrating strongly alkaline solutions, for

solutions of hydrochloric acid, and for fruit juices. For cost reasons, the load-bearing material is usually copper or steel, with silver cladding a few millimeters thick. In most cases, the two sheets of metal are bonded together by a combination of mechanical treatment and fusion, and the equipment is fabricated from the resulting composite. Alternatively, silver cladding can be applied to a finished steel construction. Vessels to withstand several hundred degrees Celsius are sometimes provided with a loosely fitting silver lining. Although this does not give optimum heat transfer, the difference in the expansion of the two metals does not constitute a risk of damage to the vessel. Vessels can also be plated internally by electrodeposition. Coatings > 50 μm thick are generally nonporous.

Silver fittings are often machined from castings. In chemical equipment, the metal can be pure silver, fine-grained silver, or oxide dispersion-hardened silver, which has better high-temperature strength.

Filter elements of sintered spheroidal silver powder are used in the food industry, principally in fruit presses. Membranes for bursting disks to protect equipment against excess pressure can be made of 0.1-0.5-mm-thick silver disks. They can be used in the range of 0.1-40 MPa at < 120 °C. Small tubes of palladium or Pd 77 Ag 23 are used in diffusion cells for the production of pure hydrogen. Pure silver and gold-silver alloys in wire or ring form are used in the manufacture of sealing materials for oxygen compressors and ultra-high-vacuum equipment.

#### 24.9.8 Catalysts [124]

Metallic silver is an excellent oxidation catalyst. Without doubt, the specific activation of oxygen at the metallic silver surface, forming an intermediate state, plays a part in catalytic activity. Usually, fairly coarse-grained metallic silver is used, because a finely divided product with very large specific surface area would in many cases cause total oxidation of

the organic substance to carbon dioxide and water.

Ethylene oxide is produced by direct oxidation of ethylene on silver catalysts at 230–270 °C [125]. These are supported on  $\alpha$ - $\text{Al}_2\text{O}_3$  or silicates and have a silver content of ca. 15%. The specific surface area of the metal is fairly low. These catalysts usually have a lifetime of several years.

Skeletal silver catalysts have also been proposed for the oxidation of ethylene to ethylene oxide [126, 127]. They are best prepared by decomposing the alloy Ag-Ca with water. However, they have not yet been used industrially.

Catalytic dehydrogenation of methanol to formaldehyde is carried out at 600–720 °C over silver gauze or crystals. Catalytic oxidative dehydrogenation of isopropanol to acetone also takes place on silver catalysts. In gas-phase reactions over silver catalysts, glyoxal is produced from glycol, and acetaldehyde from ethanol. Likewise, organic amines can be dehydrated to nitriles on silver catalysts.

### 24.9.9 Photography [128]

Almost all modern photographic technology is based on the light sensitivity of silver halides. This is true of black-and-white, X-ray, infrared, color, and instant photography.

In black-and-white photography, the light-sensitive emulsion coating consists of a gelatin layer in which silver halide crystals are suspended (two gelatin layers in X-ray films). The bromide ion is used more than chloride or iodide. The method of precipitation determines the structure of the particles in the silver halide mixture, and hence the photographic properties of the emulsion. The distribution of individual halides in the emulsion particles, the grain size, and the grain shape can be varied over a wide range, as can the bromide:chloride:iodide ratio. Properties are also influenced by physical and chemical maturing processes. In the development of black-and-white film and paper, the grains that come in contact with photons are reduced by chemi-

cals to elemental silver, to produce the black color. Silver halide grains that have not come in contact with light do not react and are dissolved by sodium thiosulfate during fixing.

In color photography, three primary colors, corresponding to the sensitivity of the human eye, must be produced. For each of the three colors, a photographically sensitive layer is required, which contains special dye components, sensitizers, and light-sensitive silver halide. On illumination, the silver halide is reduced to one of the primary colors in the layer that has been sensitized. On development, a silver image is first produced in each layer, as in black-and-white photography. An oxidation product of the developing substance is formed at the same time as elemental silver, and this couples with the dye component in each layer to form a dye, thus giving the three colored images. The three silver images are then dissolved oxidatively (bleaching), and the silver halide that has been illuminated is removed with sodium thiosulfate solution. Thus, the remaining colored image does not contain silver. Silver consumption for color photography is lower than that for black-and-white photography per unit of surface area. In all cases, high-purity silver nitrate is the starting material. Recovery of silver in color photography is a complex operation but is nevertheless economical because of the large size of most color processing laboratories.

### 24.9.10 Other Uses

Silver halides are incorporated in photochromic glasses [129, 130]. The UV component in daylight liberates elemental silver, so that the glass darkens in sunlight. As the light intensity decreases, colorless silver halide is re-formed, and the coloration decreases. The effect is used mainly in sunglasses. The change in light absorption can vary (e.g., from 10 to 50% or from 15 to 75%). Silver chloride in the form of colorless glass-clear films is used in special radiation detectors.

Molecular sieves charged with  $\text{Ag}^+$  ions are used in sea rescue for producing drinking water from seawater by the reaction

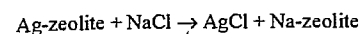

In standard sea rescue equipment, 80 g of zeolite charged with ca. 25 g of silver provides 0.4 L of drinking water.

In an increasingly used alternative to the conventional methods of removing bacteria from drinking water [131], filters containing ion exchangers or activated carbon charged with silver are used. The extent of application of this method will depend mainly on limits to the allowable silver content of drinking water in the future. The proposed maximum of 0.01 mg/L Ag is exceeded in this process.

Colloidal silver, mostly in the form of a 1% solution, is used for disinfection of swimming baths. Effective silver concentrations are ca. 0.1 mg/L. The advantage of the method over hypochlorite treatment consists mainly in the lack of odor. With more highly contaminated water (e.g., in open swimming baths) the effectiveness is generally inadequate.

Silver iodide, generally mixed with sodium chloride, can cause the precipitation of rain or hail if it is dispersed in the form of very small crystals with a particle size of ca. 0.1  $\mu\text{m}$ . These provide the necessary condensation nuclei. To produce early precipitation of hail, condensation nuclei are distributed in clouds in such numbers ( $> 100\,000\ \text{m}^{-3}$ ) that the hailstones formed are small and not dangerous [132]. Of more importance is the precipitation of rain in barren regions of the Earth.

## 24.10 Quality Specifications and Analysis [133–135]

Silver is handled in various purity grades (Table 24.11). The silver market is usually supplied with good-delivery silver. For most industrial uses, silver with a fineness of 999.7 (e.g., for alloying) or 999.9 (e.g., for electrical contacts and electroplating) is required.

Silver is supplied mainly in ingot form. For good-delivery quality, the ingot weight is generally ca. 31 kg (ca. 1000 oz). Small investors usually prefer 1000-g fine silver ingots, although many other weights are available, as required by the market (e.g., cast ingots

weighing 5000, 500, and 250 g; stamped plates weighing 100, 50, and 20 g; patterned plates normally 1 ounce in weight, or medallions). Craft workers and industrial users sometimes prefer granules, which are sold in sacks up to 20 kg content. Ingots are marked with their net weight in kilograms or troy ounces (1 troy ounce = 31.103486 g) and their fineness. Up to World War II, ingots of sterling silver were also available.

Table 24.11: Marketable silver qualities.

Name	Silver content, %	Impurities, ppm
Good-delivery silver	$\geq 99.9$	copper $\leq 900$ others $\leq 100$
Fine silver	$\geq 99.97$	copper $\leq 300$ others $\leq 50$ including lead $\leq 10$ bismuth $\leq 10$ total $\leq 300$
Fine silver 999.9	$\geq 99.99$	copper $\leq 50$ others $\leq 50$ including lead $\leq 10$ bismuth $\leq 10$
Fine silver, chemically pure	$\geq 99.995$	copper $\leq 15$ others $\leq 35$ including lead $\leq 5$ iron $\leq 5$ gold $\leq 1$ bismuth $\leq 1$
Fine silver, high purity	$\geq 99.999$	aluminum $\leq 2$ iron $\leq 2$ silicon $\leq 2$ tin $\leq 2$ lead $\leq 1$ gold $\leq 1$ cadmium $\leq 0.5$ bismuth $\leq 0.5$ copper $\leq 0.4$ manganese $\leq 0.4$ total $\leq 10$
Silver nitrate DAB 7, for photographic use	63.5	copper $\leq 2$ iron $\leq 2$ lead $\leq 10$ sulfate $\leq 10$ nitrate $\leq 10$ water insoluble not precipitated by HCl $\leq 10$ moisture $\leq 200$

Correct sampling methods are essential for the accurate determination of silver [136–138].

Samples are taken from ingots by means of holes drilled diagonally, or by producing

metal cuttings by sawing across the entire cross section at various parts of the ingot. Similar methods are used for semifinished products. If possible, nonhomogeneous materials are melted and cast into ingots that can be sampled.

Silver-containing waste liquids may contain sediments and deposits on the vessel walls that can be removed by filtration or dissolution, or samples can be taken after stirring.

Products in lump or powder form that cannot be melted, such as dross, are ground and sieved. The fine and coarse fractions are analyzed separately. If a metallic coarse fraction is obtained, this can be melted.

Special methods have been developed for sampling large amounts of ore, after which the above procedures are carried out.

### 24.10.1 Qualitative Analysis

The qualitative analysis of silver [134] is in practice usually a preliminary to quantitative analysis.

**Chemical Methods.** Silver in solution is generally determined by precipitating white silver chloride by addition of chloride. It is dissolved as  $[\text{Ag}(\text{NH}_3)_2]^+$  by the addition of ammonia and reprecipitated on acidifying with nitric acid. For low silver content, chloride addition produces only a characteristic cloudiness. If the solution contains cyanide, thiosulfate, ammonia, or hydrochloric acid, silver chloride cannot be precipitated because soluble silver complexes are formed. If necessary, the complex formers can be decomposed by oxidation or change of pH.

Photometric methods of determination also exist [139], but these are seldom used because of possible interference from other metallic ions and the reliability of the AgCl precipitation method.

**Physical Methods.** Atomic absorption spectroscopy [140] is useful for qualitative determination of silver in solution (e.g., in wastewater). However, silver concentrations in the solutions must be known not to be too high; otherwise, the acetylene-air flame gen-

erally used to excite silver ions can lead to the formation of highly explosive silver acetylide. In the past, this has caused explosions in analytical equipment.

Emission spectroscopy, X-ray fluorescence spectroscopy, and other physical methods of qualitative analysis are also suitable.

**Docimasy** [134, 135] can, in principle, be used for qualitative analysis. Here, all the base metals in a sample are converted to slag, leaving a bead of silver. Products of cementation or residues from the evaporation of solutions can also be analyzed by this method.

### 24.10.2 Quantitative Analysis and Accountancy Analysis [22, 133, 135, 136]

A large proportion of the 15 000 t silver used annually by industry, with a total value of  $(3-4) \times 10^9$  DM, is converted by the users into alloys or into many varied forms suitable for recycling. The silver analyses of these materials must therefore be highly accurate, since the results are used to calculate the sales value of the products.

**Docimasy** [134, 136], which has been used for hundreds of years to determine the value of silver and gold, is the most important method of quantitative analysis. Here, noble metals in the samples are taken up by molten lead, and base materials are converted to slag. In the crucible assay, a mixture of lead oxide, reducing agent, and fluxes is melted at ca. 1250 °C in a crucible. In the scorification assay, the sample is melted with granular lead and borax at ca. 1000 °C under oxidized conditions. The lead is finally oxidized at ca. 800 °C to litharge (cupellation), and a bead of noble metal is left behind while PbO is absorbed into the porous magnesite base (cupel). If the bead contains several noble metals, a wet chemical or physical analysis is carried out. Direct X-ray fluorescence analysis of the bead is also possible, and has the advantage of greater speed and lower cost.

Docimastic techniques have recently been improved to give even greater accuracy.

**Volumetric Determination of Silver** [134-136, 141, 142]. The volumetric titration of GAY-LUSSAC is still used today. In this method, a solution acidified with nitric acid is titrated with NaCl solution, to precipitate silver chloride. The so-called clear point or end point of the nitration is determined by visual observation. A high degree of accuracy can be obtained by precise control of titration conditions, which are established in a previous determination of the approximate silver content of the sample to be analyzed. Hardly any interference results from the usual elements that accompany silver (Cu, Zn, Ni, etc.), but lead, mercury, and tin can cause problems. This method is still used for umpire assays.

Potentiometric titration also depends on the precipitation of silver chloride by the controlled addition of NaCl solution acidified with nitric acid. In some cases, because of the even lower solubility of the other silver halides, sodium bromide or sodium iodide is also used as precipitation agent. Automation of the potentiometric titration process enables this method to be used for routine determinations. Modern automated titration equipment with potentiometric endpoint indication, can analyze up to 30 sample solutions per hour. The potentiometric determination of silver is even less subject to interference than Gay-Lussac titration. In recent decades, it has become the principal method of silver determination.

The determination of silver in solutions acidified with nitric acid by Volhard titration is based on the precipitation of insoluble silver thiocyanate in the presence of  $\text{Fe}^{3+}$  ions. The end point is detected by the brown coloration of the solution by iron(III) rhodanide. The method is not very accurate and is used mainly for internal plant control analysis.

Other gravimetric methods have decreased in importance. These include the precipitation of silver iodide by  $\text{I}^-$  ions, followed by iodometric titration of excess iodide; the Fajans titration with adsorption indicators; and titration with dithizone. The Mohr titration is rarely used for silver determination but was formerly used for halide determination.

A volumetric method that has recently become important is the precipitation of  $\text{Ag}_2\text{S}$ , in which the end point is detected by voltametry [143] or by determining the EMF of a silver-sensitive electrode [142, 144].

**Gravimetric Determination of Silver.** The most important gravimetric method is the precipitation of silver chloride in hot solution acidified with hydrochloric acid. Silver chloride can be weighed directly or reduced with hydrazine in ammoniacal solution to obtain the metal. Gravimetric determination with organic precipitants is described in [139, 145].

**Physical Methods.** In systems of known constitution (e.g., silver brazing alloys or jewelry alloys), X-ray fluorescence analysis can be carried out [146-148] with an accuracy comparable to that of wet chemical methods and hence adequate for accountancy purposes. The silver button produced by docimasy can also be analyzed by X-ray fluorescence.

Atomic emission spectroscopy with glow discharge, spark or plasma excitation is being used increasingly for the quantitative determination of silver in its alloys.

Atomic absorption spectroscopy (AAS) is less accurate and therefore more often used for process control analysis than for accounting purposes. If the solutions used have high concentrations of silver, a danger exists of  $\text{Ag}_2\text{C}_2$  formation in the acetylene flame, so the solutions analyzed must be very dilute.

### 24.10.3 Purity Analysis

In purity control of silver, the fineness is calculated from the sum of the impurities. The fineness of metal or the purity of compounds was formerly determined by docimasy, supplemented by wet chemical determination of the main impurities. Today, metal samples, pressings, or solutions are analyzed by emission spectroscopy [149, 150]. For this, plasma excitation is increasingly used due to the better limits of detection, and the possibility of rapid simultaneous analysis and lower costs. Atomic absorption analysis and polarography are also used for analysis of trace impurities.

High-performance liquid chromatography is less important. In some cases, especially for ultrapure materials, mass spectrometry is used, more recently with glow discharge excitation and neutron activation.

The fineness of noble metals can be determined much more accurately from the sum of the impurities than by direct analysis of the noble-metal matrix. Physical methods of trace analysis have largely replaced wet chemical and colorimetric methods for reasons of economy and speed.

#### 24.10.4 Trace Analysis

Apart from docimasy, which is used mainly for oxidic drosses, silver-containing ores, and precipitates from solutions, all other methods of silver determination are also used for trace analysis. For extremely low levels of impurities, other methods are used, including graphite-tube AAS, neutron activation analysis, total reflection X-ray fluorescence analysis, and inductively coupled plasma spectrometry. Photometric methods are rarely used, but AgCl formation is measured by nephelometry [151].

The maximum allowed concentration of silver in wastewater is very important now because of the widespread use of biological wastewater treatment. Silver(I) ions interfere with the biological equilibrium at a concentration of > 0.04 ppm. Atomic absorption spectroscopy is widely used for wastewater analysis.

Trace analysis of noble metals in waste materials from the noble-metal industry, especially scrap recovery plants, is of great importance for checking the economic efficiency of the process.

#### 24.10.5 Argentometry [141, 142]

The precipitation reactions used for volumetric determination of silver can also be used for determination of ions that form insoluble precipitates with Ag<sup>+</sup>. Techniques for determining chloride, bromide, iodide, cyanide, thiocyanate, etc., which are derived from the

methods described for silver are generally known as argentometry and include the following:

- Potentiometric titration of halides by the controlled addition of AgNO<sub>3</sub> solution
- Reverse GAY-LUSSAC titration for determination of halides and cyanides
- Reverse Volhard titration for determination of halides, cyanide, or thiocyanate

Argentometric methods employing chemical indicators are rarely used.

### 24.11 Economic Aspects

[15, 16, 22]

#### 24.11.1 Production

Of all the noble metals, silver comes first in terms of annual production. In terms of value, however gold exceeds silver by a factor of 15 (Table 24.12).

In 1992, the amount of silver produced worldwide by mining was 11 400 t, and the amount recovered from scrap materials was 3600 t. The largest producers of silver are Mexico, the United States, Peru, Canada, and Australia in that order. This has been true since the end of World War II.

Table 24.12: Value of noble-metal production in 1992.

Metal	Primary production, t/a	Price, DM/g	Total value, 10 <sup>6</sup> DM
Au	1800	18	32 400
Ag	11 500	0.2	2200
Pt	120	19	2300
Pd	115	5	600
Rh	12	128	1500
Ru	12	2	20
Ir	1	11	10
Os	0.5	26	13

#### 24.11.2 Supply and Demand

The supply of silver to the world market (Figure 24.9) is mainly determined by production from mines. The amount produced is relatively insensitive to price movements, which are sometimes large and generally of a speculative nature, because silver is mainly a side

product of the extraction of base metals. Also, market price fluctuations are reflected to only a limited extent in production from recycled materials. However, government sales, and sometimes purchases, are strongly dependent on price changes. Sales of silver from the CIS have a relatively small influence on the total supply situation in the Western world in spite of the considerable production in this region. Also, in comparison to gold and the platinum-group metals, large amounts of silver are frequently released to the world market from the old stocks in India, estimated at around 120 000 t. This material was accumulated many years ago from domestic production and commercial transactions. The total stocks of the Western world (excluding India) amount to ca. 80 000 t, of which approximately 50% is owned by the U.S. government.

The demand for silver (Figure 24.10) is fairly well matched by the supply. The relatively even distribution of demand over various sectors is not expected to change fundamentally in the foreseeable future. However, the relatively small extent of known silver reserves in ores, compared to other metals, could in the future lead to a change in stockpiling practice. The greatly increasing status of silver as an industrial metal could also have major effects. In technology, an important factor in the future is likely to be a decrease in the importance of classical silver-based photography, to the benefit of electronic image-making techniques.

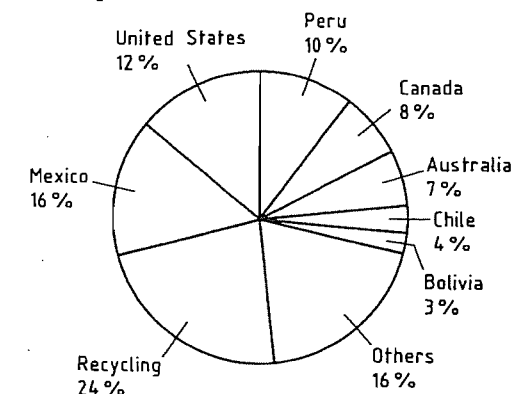

Figure 24.9: Western world silver supplies, 1992.

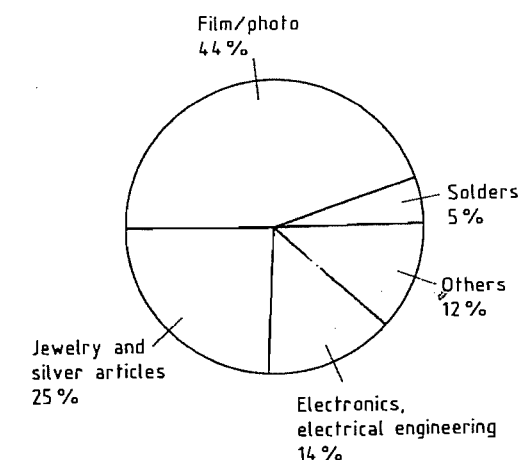

Figure 24.10: Western world silver consumption, 1992.

#### 24.11.3 Silver Market and Trading

The most important silver exchanges are the New York Commodity Exchange; Chicago Board of Trade; West Coast Commodity Exchange Los Angeles; and Broker's Market London, which provides daily price information. Bargains are struck in London for delivery promptly or after 3, 6, or 12 months. The amounts of silver transferred yearly are often more than two orders of magnitude greater than the world's demand for silver.

On June 22, 1992, the price of silver was \$4.30 per ounce (DM 227/kg), having remained around this low level for many years. The low point of \$3.65 per ounce (DM 180/kg) reached in 1972 was again reached in 1992.

### 24.12 Health and Safety [2, 44, 152, 153]

#### 24.12.1 Toxicology [152, 154, 155]

The acute and chronic toxicity of silver compounds in humans is much lower than that of other heavy metals such as mercury, thallium, or cadmium. This is due mainly to their rapid conversion into insoluble silver compounds, especially silver chloride and silver albuminate, in the body. The LD<sub>50</sub> for soluble

silver compounds is 50–500 mg/kg as Ag. Almost the only cause of acute silver poisoning is accidental overdosing with silver-containing pharmaceuticals. The main hazard of the water-soluble compounds silver nitrate and silver fluoride is a caustic effect of fluoride toxicity, respectively.

Prolonged contact with silver compounds or finely divided elemental silver leads to absorption of the metal by the human body. This can cause argyria, which has no pathological effects but can lead to a disfiguring darkening of the skin, beginning with mirror effects on the pupils of the eyes and coloration of the skin exposed to light. This effect is irreversible and cannot be treated medically. In addition to the deposition of elemental silver, silver sulfide may be formed. In cases of severe argyria, a person can absorb up to 20 g of silver. The silver is usually taken up from respired air, although excessive doses of silver-containing drugs (e.g., colloidal silver) can also lead to argyria. Workers involved in the production of silver nitrate and in silver-plating processes face the greatest risk.

The MAK value for elemental silver and soluble silver compounds is 0.01 mg/m<sup>3</sup> as Ag. This is intended mainly to prevent argyria and is not a true toxicity limit. For drinking water, the limit is 0.05 mg/L.

### 24.12.2 Bactericidal (Oligodynamic) Effect

The use of silver preparations in medicine and in water purification depends on the sensitivity of bacterial metabolism to silver ions. Their advantage compared to other bactericidal metallic ions such as Hg<sup>2+</sup> lies in the fact that the effective Ag<sup>+</sup> concentrations lie well below the danger level for the human organism (i.e., at 0.01–1 mg/L). Hence, even sparingly soluble compounds such as silver chloride have a bactericidal effect, but the extremely insoluble compound silver sulfide does not.

In the presence of atmospheric oxygen, metallic silver also has a bactericidal effect due to the formation of silver oxide, which is soluble

enough to cause it. Bactericidal concentrations are produced extremely rapidly by adding colloidal silver, which has a high surface area, but even objects with a solid silver surface (e.g., table silver, silver coins, or silver foil) have a bactericidal effect in the absence of sulfide, which would otherwise combine with the Ag<sup>+</sup> ions.

The death of microorganisms such as bacteria, molds, spores, and fungi on contact with silver articles was discovered by VON NÄGELI (1817–1891), although he did not identify the cause. The effect was certainly used in antiquity, and silver drinking vessels were carried by military commanders on expeditions for protection against disease. NÄGELI named the effect that he discovered the oligodynamic effect. This is now generally understood to mean the damaging effect of very small amounts of metallic cations on living cells.

### 24.12.3 Explosion Hazards

Silver forms many unstable compounds (see Section 24.7.7) that can explode or detonate on thermal or mechanical stress, on drying, under the influence of light, or sometimes spontaneously without any known cause. This group includes several nitrogen compounds of silver, organic compounds (especially silver acetylide and its derivatives), and silver(II) oxide in contact with finely divided organic materials.

Since some of these compounds can be formed by reaction with elemental silver, acetylene and ammonia in the gaseous or liquid state should not be allowed to come in contact with items of equipment made of silver or its alloys. Also, silver and its compounds must be kept away from acetylene flames.

Silver salts of strongly oxidizing acids (e.g., silver chlorate and nitrate) can lead to dangerous explosions on contact with oxidizable materials (e.g., organic substances, sulfur, soot). Contact of silver nitrate with alcohol leads to immediate formation of explosive silver fulminate. Many explosions have resulted from formation of nitride in ammoniacal solutions of silver. Silver oxalate is reported to de-

compose at 140 °C, but explosions have occurred on drying at 80 °C.

## 24.13 References

- R. Kerschagl: *Silber, Metallische Rohstoffe*, vol. 13, Enke, Stuttgart 1961.
- A. Butts, C. D. Cox: *Silver—Economics, Metallurgy, and Use*, R. E. Krieger Publ. Co., Huntington 1975.
- V. Tafel: *Lehrbuch der Metallhüttenkunde*, Hirzel, Leipzig 1951.
- D. Büttner, *Naturwiss. Unterr. Phys/Chem.* **28** (1980) 129–140.
- A. Binz: *Edelmetalle, ihr Fluch und ihr Segen*, W. Limpert, Berlin 1943.
- H. Römpf: *Chemie der Metalle*, Franckh'sche Verlagshandlung, Stuttgart 1941.
- N. H. Gale, W. Gentner, G. A. Wagner, *Metall. Numis.* **1** (1980) 3–49.
- W. Gentner, H. Gropengießer, G. A. Wagner, *Mannheimer Forum* 1979/80, Boehringer Mannheim.
- W. Gentner, O. Müller, G. A. Wagner, N. H. Gale, *Naturwissenschaften* **65** (1978) 273–284.
- E. Permicka, *Erzmetall* **34** (1981) 396–400.
- H.-G. Bachmann, *Erzmetall* **35** (1982) no. 5, 246.
- C. Schnabel: *Lehrbuch der allgemeinen Hüttenkunde*, Springer, Berlin 1913.
- G. Agricola: *Vom Berg- und Hüttenwesen*, Deutscher Taschenbuchverlag, München 1980.
- L. Suhling: *Der Seigerhüttenprozess*, Riederer Verlag, Stuttgart 1976.
- W. Gocht: *Handbuch der Metallmärkte*, 2nd ed., Springer Verlag, Berlin 1985.
- E. Schmidt, *Metall* **47** (1993) 644–667.
- S. D. Dial, *Metall (Berlin)* **35** (1981) 580–590.
- Degussa: *Edelmetall-Taschenbuch*, Frankfurt 1967.
- Gmelin, Silber, System no. 61, 1970/76.
- G. H. Aylward, T. J. Findlay: *Datensammlung Chemie*, Verlag Chemie, Weinheim 1975.
- E. Fluck, K. G. Heumann: *Periodic Table of the Elements*, VCH Verlagsgesellschaft, Weinheim 1986.
- Fonds der Chemischen Industrie: *Edelmetalle—Gewinnung, Verarbeitung, Anwendung*, Folienserie no. 12, Frankfurt/Main 1989.
- Degussa: *Edelmetall-Taschenbuch*, 2nd ed., Metallverlag, Berlin 1994, in press.
- D. G. Cooper: *Das Periodensystem der Elemente*, Verlag Chemie, Weinheim 1972.
- D. Mehdows, E. Zahn, P. Milling: *Die Grenzen des Wachstums*, Deutsche Verlagsanstalt, Stuttgart 1972/1979.
- N. N. Grennwood, A. Earnshaw: *Chemie der Elemente*, VCH Verlagsgesellschaft, Weinheim 1988.
- F. Pawlek: *Metallhüttenkunde*, Walter de Gruyter, Berlin 1983.
- D. F. Schutz, K. K. Turekian, *Geochim. Cosmochim. Acta* **29** (1965) 259–313.
- H. Schneiderhöhn: *Erzlagerstätten*, G. Fischer Verlag, Stuttgart 1962.
- A. Cissarz: *Einführung in die allgemeine und systematische Lagerstättenlehre*, E. Schweizerbart'sche Verlagsbuchhandlung, Stuttgart 1965.

- Metallgesellschaft: *Die Welt der Metalle—Kupfer (Kupferatlas), The World of Metals—Copper*, Frankfurt 1993.
- Metallgesellschaft: *Die Welt der Metalle—Blei, Zink*, Frankfurt 1994, in press.
- L. van Zyl, C. P. Schreuder (eds.): *South Africa's Mineral Industry*, Department of Mineral and Energy Affairs, Bramfontein 1991/92.
- R. Saager: *Metallische Rohstoffe von Antimon bis Zirkonium*, Bank Vontobel, Zürich 1984.
- Degussa: *Recycling — Rohstoffsicherung und Umweltschutz*, Frankfurt 1981.
- National Association of Recycling Industries: *Precious Metals*, New York 1980.
- E. Krone, W. Dähne, *Chem. Ztg.* **1977**, 421–425.
- W. Kumpf, K. Maas, H. Straub, G. Hösel, W. Schenkel: *Müll- und Abfallbeseitigung (Müll-Handbuch)*, Kennzahl 8572 (C. Knorr: Rückgewinnung von Silber aus photographischen Rückständen), Kennzahl 8595 (H. Renner: Behandlung und Verwertung von verbrauchten edelmetallhaltigen Katalysatoren), Erich Schmidt Verlag, Berlin 1980/81.
- W. W. Behning, *Metall (Berlin)* **24** (1970) 794–796.
- W. Dähne: *Recycling von Silber aus Fotomaterialien*, GDMB Gesellschaft Deutscher Metallhütten- und Bergleute, no. 3, lecture of 10/23, Nov. 1991 in Würzburg, Clausthal-Zellerfeld 1991.
- D. H. Chambers, B. W. Dunning: *Silver Recovery from Aircraft Scrap*, Report no. 8477, Bureau of Mines, Washington 1980.
- Ullmann, 3rd ed., 15, 630.
- K. Winnacker, L. Küchler: *Chemische Technologie*, 4th ed., vol. 6, Carl Hanser Verlag, München 1986.
- Kirk-Othmer, 3rd ed. 21, 1–31.
- H. J. Bovey, S. Marks, *S. Afr. Chem. Process* **4** (1969) no. 2, 28–34.
- M. Toyoda, A. Ohta, T. Shimizu: *Slime Treatment at Niihama Copper Refinery*, Metallurgical Society of AIME, New York 1976.
- F. Habashi, *Chem. Ztg.* **86** (1962) 483–487.
- R. A. Zingaro, W. C. Cooper: *Selenium*, Van Nostrand Reinhold, New York 1974.
- W. C. Cooper: *Tellurium*, Van Nostrand Reinhold, New York 1971.
- J. Feiser: *Nebenmetalle. Die metallischen Rohstoffe*, vol. 17, Enke, Stuttgart 1966.
- W. Schreiter: *Seltene Metalle*, vols. II and III, Deutscher Verlag f. Grundstoffindustrie, Leipzig 1961.
- Inko, DE-OS 2914439, 1979.
- American Metal Climax, DE 2117513, 1971.
- W. Truthe: *Hundert Jahre Gold- und Silberscheidung nebst Gewinnung der Platinmetalle*, Degussa, Frankfurt 1943, unpublished.
- G. A. Walker: "Recovery and Refining of Secondary Silver", 9th Commonwealth Mining and Metallurgical Congress, London 1969.
- Degussa: *Metall—Forschung und Entwicklung*, Frankfurt/M. 1991.
- Degussa, DE 2059235, 1970.
- Outokumpu Oy, DE 2543027, 1975.
- G. Eger: *Das Scheiden der Edelmetalle durch Elektrolyse*, W. Knapp, Halle 1929.
- Dietzel, DE 68990, 1892; DE 82390, 1895.
- H. Walden, *Chem. Ing. Tech.* **36** (1964) 647–651.

62. Kodak: *Die Silberrückgewinnung in der Fotografie*, Stuttgart 1972.
63. Kodak, US 2944886, 1958.
64. Cendres & Métaux, CH 613787, 1976.
65. Röhm GmbH: Ablösen der silberhaltigen Gelatineschicht von Filmabfällen, Company brochure, Darmstadt 1977.
66. B. Krauß, *Moderne Fototechnik* 1979, 125–127, 237–240, 433–437.
67. E. Mutter, *Röntgen-Laboratoriumsprax.* 13 (1960) 158–165, 175–191.
68. H. Aisenberg, U. Fritz, *Röntgenpraxis (Stuttgart)* 19 (1966) 284–307.
69. G. Kolf, *Chem. Lab. Betr.* 32 (1981) 43–48.
70. W. Großmann, *Moderne Fototechnik* 1980, 557–558.
71. Degussa: TMT 15 für die Abtrennung von Schwermetallen aus Abwässern (Reihe Umwelt und Degussa), Frankfurt 1980.
72. Minesota Mining, US 4110109, 1978.
73. Siemens, DE-AS 2543600, 1975.
74. Ciba-Geigy, US 4186067, 1978.
75. Comptoir Lyon-Alemand, Louyot & Co.: Procédé Purhypo, Company brochure, Paris 1979.
76. Degussa: Behandlung photochemischer Abwässer mit Wasserstoffperoxid (Reihe Umwelt und Degussa), Frankfurt 1980.
77. R. Mina: "Silver Recovery from Photographic Effluents by Ion Exchange Methods", SPSE-Symposium, Las Vegas 1980.
78. D. J. Degenkolb, F. J. Scobey, *J. Soc. Motion Pict. Telev. Eng.* 86 (1977) 66–68.
79. C. Ramsey: Ion Exchange for Silver Removal from Effluents, PMA Fall Seminar, 1979.
80. MacDermid Inc., US 3242090, 1964.
81. J. W. Hunter: "Electrochemical Principles and Refining", IPMI-Seminar, Skytop Lodge 1980.
82. Brookside Metal Comp., CH 614238, 1974; US 3975244, 1976.
83. A. Prior, R. Marr, H. J. Bart in: Raffinationsverfahren in der Metallurgie, Verlag Chemie, Weinheim 1983, pp. 243–252.
84. G. Brauer: Handbuch der präparativen anorganischen Chemie, vol. 2, Enke, Stuttgart 1978.
85. L. Vanino: *Präparative Chemie*, vol. 1, Ferdinand Enke Verlag, Stuttgart 1925.
86. N. R. Thompson: *Comprehensive Inorganic Chemistry*, vol. 17, Pergamon Press, Oxford 1973.
87. Du Pont, US 2614029, 1951.
88. Du Pont, US 2543792, 1949.
89. Du Pont, US 2940828, 1957.
90. W. A. Chalkin, E. Herrmann, J. W. Norseev, I. Dreyer, *Chem. Ztg.* 101 (1977) 470–481.
91. JANAF, Thermochemical Tables, NSRDS-NBS 37, 1971; Supplements 1974, 1975, 1976, 1978.
92. O. Kubaschewski, C. B. Alcock: *Metallurgical Thermochemistry*, Pergamon Press, New York 1978.
93. I. Barin, O. Knacke, O. Kubaschewski: *Thermodynamical Properties Inorganic Substances*, Springer, New York 1977.
94. Varta, DT 2430910, 1974.
95. A. M. Golub et al.: *Chemie der Pseudohalogenide*, Hüthig Verlag, Heidelberg 1979.
96. IUPAC: *Regeln für die Nomenklatur der Anorganischen Chemie*, Verlag Chemie, Weinheim 1970.
97. A. F. Holleman, E. Wiberg: *Lehrbuch der Anorganischen Chemie*, de Gruyter, Berlin 1976.
98. A. Stettbacher, *Explosivstoffe* 2 (1954) 1.
99. W. Romanowski, S. Engels: *Hochdisperse Metalle*, VCH Verlagsgesellschaft, Weinheim, in press.
100. H. Stegemann, DE-AS P 31196357, 1981.
101. W. Ostwald: *Die Welt der vernachlässigten Dimensionen*, Th. Steinkopff, Dresden 1927.
102. Degussa, DE 2302277, 1973.
103. A. A. Boraiko, *National Geographic* 160 (1981) 280–313.
104. A. Luschin v. Ebengreuth: *Allgemeine Münzkunde und Goldgeschichte*, R. Oldenbourg, München 1971.
105. W. Londershausen, *Metall (Berlin)* 35 (1981) 465–466.
106. M. Rosenberg: *Goldmerkmale*, Frankfurter Verlagsanstalt, Frankfurt 1922.
107. A. Bult, *Pharm. Weekbl. Sci. Ed.* 3 (1981) 213–223.
108. E. v. Angerer, H. Ebert: *Technische Kunstgriffe bei physikalischen Untersuchungen*, Vieweg u. Sohn, Braunschweig 1964.
109. J. Fischer: *Galvanische Edelmetallüberzüge*, Leuze Verlag, Saulgau 1960.
110. H. W. Dettner, J. Elze, E. Raub: *Handbuch der Galvanotechnik*, C. Hanser, München 1966.
111. A. v. Krusenstjern: *Edelmetallgalvanotechnik*, Leuze Verlag, Saulgau 1970.
112. A. Keil, *Metalloberfläche* 9 (1955) A81.
113. Deutscher Normenausschuß (ed.): *Versilberte Bestecke*, RAL 691 B 3, Beuth-Vertrieb, Berlin 1969.
114. G. Brauer: *Handbuch der präparativen anorganischen Chemie*, 1st ed., Enke, Stuttgart 1954.
115. Degussa, DE-OS 2803060, 1978.
116. A. Keil: *Werkstoffe für elektrische Kontakte*, Springer Verlag, Berlin 1960.
117. W. Böhm, N. Behrens, M. Clasing, *Metall (Berlin)* 35 (1981) 539–543.
118. K.-W. Jäger, B. Gegenbach, *Metall (Berlin)* 35 (1981) 534–539.
119. M. Poniatowski, K.-H. Schröder, F. D. Schulz, *Metall (Berlin)* 31 (1977) 1338–1342.
120. M. Lindmayer, *Metall (Berlin)* 34 (1980) 621–625.
121. G. Reinacher, *Chem. Anlagen + Verfahren* 1972, no. 5, 44–46.
122. Degussa: *Silberhalbzeug*, Hanau 1980.
123. R. Bock: *Aufschlußmethoden der anorganischen Chemie*, Verlag Chemie, Weinheim 1972.
124. K. Weißermel, H.-J. Arpe: *Industrielle organische Chemie*, Verlag Chemie, Weinheim 1978.
125. S. Rebsdatt, S. Mayer, J. Alfranseder, *Chem. Ing. Tech.* 53 (1981) 850–854.
126. A. Camborn, D. Alexander, *Can. J. Chem.* 34 (1956) 665.
127. B. M. Bogolowski, S. Kasakowa: *Skelettkatalysatoren in der organischen Chemie*, Dt. Verlag der Wissenschaften, Ostberlin 1960.
128. Fonds der Chemischen Industrie: *Silber-Fotographie*, Folienserie no. 23, Frankfurt/Main 1989.
129. B. J. L. Kratzer, *DOZ Dtsch. Optikerztg.* 33 (1978) 153–156.
130. W. Grimm, *DOZ Dtsch. Optikerztg.* 34 (1979) 173–180.
131. F. Krusche: *Die Trinkwassersilberung*, Verlag R. Oldenbourg, München 1957.
132. B. Federer, *Umsch. Wiss. Tech.* 79 (1979) 463–468.
133. H. Pohl: Studie über Problem der chemischen Edelmetallanalyse, Forschungsbericht Nr. 15 der Bundesanstalt für Materialprüfung (BAM), Berlin 1972.
134. *Edelmetall-Analyse*, Springer Verlag, Berlin 1964.
135. *Handbuch der analytischen Chemie*, 3rd part, vol. 1, Springer Verlag, Berlin 1967.
136. *Analyse der Metalle*, Springer Verlag, Berlin 1961–1975.
137. H.-M. Lüschoff in Ges. Dt. Metallhütten- und Bergleute (eds.): *Probenahme, Theorie und Praxis*, Verlag Chemie, Weinheim 1980.
138. P. M. Gy: *Sampling of Particulate Materials*, Elsevier, Amsterdam 1979.
139. J. Fries, H. Getrost: *Organische Reagentien für die anorganische Spurenanalyse*, E. Merck, Darmstadt 1975.
140. B. Welz: *Atomabsorptionsspektroskopie*, 2nd ed., Verlag Chemie, Weinheim 1975.
141. G. Jander, K. F. Jahr, H. Knoll: *Maßanalyse*, vol. II, Sammlung Göschen vol. 1002, Walter de Gruyter, Berlin 1973.
142. *Metrohm-Information*, Jahrgang 1 (1971); Jahrgang 11 (1981).
143. K. Lenhardt, *Erzmetall* 28 (1975) 172–177.
144. A. M. Bond: *Modern Polarographic Methods in Analytical Chemistry*, Marcel Dekker, New York 1980.
145. W. Prodinger: *Organische Fällungsmittel in der quantitativen Analyse*, Enke, Stuttgart 1954.
146. H. G. Bachmann, E. Koberstein, R. Straub, *Chem. Tech. (Heidelberg)* 7 (1978) 441–446.
147. J. Suchomel, *Fresenius' Z. Anal. Chem.* 300 (1980) 257–266.
148. J. Suchomel, *Fresenius' Z. Anal. Chem.* 307 (1981) 14–18.
149. H. M. Lüschoff in K.-H. Koch, H. Maßmann (eds.): Tagungsband der 13. Spektrometertagung 1980, de Gruyter, Berlin 1981.
150. W. Diehl, *Metall (Berlin)* 23 (1967) 587–589.
151. B. Lange: *Kolorimetrische Analyse*, Verlag Chemie, Weinheim 1962.
152. E. Merian (ed.): *Metals and their Compounds in the Environments—Occurrence, Analysis and Biological Relevance*, 2nd ed., VCH Verlagsgesellschaft, Weinheim 1989.
153. L. Friberg, G. F. Nordberg, V. B. Vouk: *Handbook on the Toxicology of Metals*, Elsevier, Amsterdam 1979.
154. W. Dähne: MAK-Wert für Silber, Bericht über das Geschäftsjahr 1978 der Fachvereinigung Edelmetalle e.V., Düsseldorf 1979.
155. D. Henschler in Deutsche Forschungsgemeinschaft (eds.): *Gesundheitsschädliche Arbeitsstoffe*, Verlag Chemie, Weinheim 1979.



## 25 Platinum Group Metals

HERMANN RENNER

25.1	History	1269	25.6.9	Construction Materials	1301
25.2	Properties	1272	25.7	Compounds	1301
25.3	Occurrence	1275	25.7.1	Platinum Compounds	1301
25.3.1	Abundance	1275	25.7.2	Palladium Compounds	1303
25.3.2	Ores and Their Origin	1275	25.7.3	Rhodium Compounds	1303
25.3.3	Primary Deposits	1276	25.7.4	Iridium Compounds	1304
25.3.4	Secondary Deposits	1278	25.7.5	Ruthenium Compounds	1304
25.3.5	Recovery of Secondary Platinum Group Metals	1278	25.7.6	Osmium Compounds	1304
25.3.6	Reserves and Resources	1279	25.8	Quality Specifications and Analysis	1304
25.4	Mineral Dressing	1281	25.9	Uses	1307
25.4.1	Alluvial Platinum Deposits	1281	25.9.1	Jewelry, Coinage, Investment	1307
25.4.2	Primary Deposits	1281	25.9.2	Apparatus	1307
25.4.3	Nickel Ores	1282	25.9.3	Heterogeneous Catalysts	1308
25.4.4	Metal Scrap	1283	25.9.4	Homogeneous Catalysts	1310
25.4.5	Dross	1283	25.9.5	Automobile Exhaust Catalysts	1310
25.4.6	Supported Catalysts	1284	25.9.6	Sensors	1311
25.4.7	Treatment of Solutions	1285	25.9.7	Electrical Technology	1312
25.5	Dissolution Methods	1285	25.9.8	Electronics	1312
25.5.1	Dissolution in Aqua Regia	1285	25.9.9	Coatings	1313
25.5.2	Dissolution in Hydrochloric Acid-Chlorine	1286	25.9.9.1	Coatings Produced by Aqueous Electrolysis	1313
25.5.3	Dissolution in Hydrochloric Acid-Bromine	1286	25.9.9.2	Coatings Produced by Chemical Reaction	1314
25.5.4	Other Dissolution Processes	1286	25.9.9.3	Coatings Produced by Physical Methods	1314
25.5.5	Salt Fusion	1287	25.9.10	Dental Materials	1314
25.6	Separation of Platinum Group Metals	1287	25.10	Economic Aspects	1315
25.6.1	Chemistry of Platinum Group Metal Separation	1288	25.10.1	Supply	1315
25.6.2	Old Separation Processes	1290	25.10.2	Demand	1316
25.6.3	Current Separation Processes	1293	25.10.3	Prices	1317
25.6.4	Processes Used in Coarse Separation	1293	25.10.4	Producers	1317
25.6.5	Purification	1297	25.10.5	Commercial Aspects	1318
25.6.6	Conversion of Salts into Metals	1298	25.11	Health and Safety	1319
25.6.7	Partial Purification	1300	25.11.1	Toxicology	1319
25.6.8	Treatment of Internally Recycled Material	1300	25.11.2	Explosion Hazards	1320
			25.12	References	1321

### 25.1 History [1-10]

**Early Times.** The earliest evidence of platinum is provided by a gold etui covered with hieroglyphic inscriptions, dating from the 7th century B.C. Around 1900, BERTHELOT (1827-1907) investigated the etui, which was kept in

the Louvre, and found that some of the inlays hitherto thought to be silver were in fact platinum.

In ca. 1900, Jewelry made of native platinum was discovered in Ecuador, which was part of the Inca empire in pre-Columbian

times. This probably dates from the first five centuries A.D.

In ancient times, the technique of washing river sands and fusing together the grains of platinum was undoubtedly known, as was the making of alloys by heating alluvial platinum and gold with a blowpipe, these methods being similar to those used in gold extraction and working. Pre-Columbian Indians were familiar with a powder metallurgy technique.

**16th–18th Century** [11, 12]. In their search for gold in the New World, particularly in the area of present-day Colombia, the Spanish often found alluvial (“placer”) platinum. The earliest written report of the metal was made in 1557 by J. C. SCALIGER (1484–1558). However, platinum was worked to produce jewelry and utensils only after man had learned that the metal, initially believed to be infusible, could be melted and cast by first adding other metals to lower its melting point. Platinum was essentially regarded as a troublesome material, accompanying gold and silver, which lowered their workability. The Spanish named the metal *platina*, the diminutive form of *plata* (silver), as a derogatory term because it was found only in small quantities or as small granules. The terms “white gold” and “heavy silver” were also sometimes used. When the metal became well known in Europe in 1748, thanks to the Spanish mathematician A. DE ULLOA (1716–1795), the demand for platinum increased. Its high density enabled it to be used to adulterate gold, and its introduction into Europe was therefore prohibited. Until 1908, the price of platinum was lower than that of gold. Around 1750, the scientific investigation of platinum began, initiated largely by C. WOOD (1702–1774), who learned of the metal in Jamaica in 1741. He can be regarded as the true discoverer of platinum, having presented a paper in 1750 to the Royal Society entitled “The New Semi-Metal Called Platina”. In this initial period, fundamental investigations into the chemistry of platinum (solubility in aqua regia, precipitation by addition of ammonium chloride, fusion by addition of arsenic, lead cupellation, etc.) were

carried out by W. WATSON (1715–1787), W. LEWIS (1708–1781), and others. These workers, including WOOD often collaborated. Research at this time had as its primary aim, distinguishing and separating platinum and gold, although platinum was at first widely believed to consist of gold contaminated with other elements.

An important development in platinum technology was the technique of converting the alluvial (placer) deposits into platinum sponge, which could be satisfactorily formed by heat into compact platinum or platinum artifacts. F. C. ACHARD (1753–1821) discovered the method of oxidizing an easily fusible platinum–arsenic alloy to remove arsenic. As early as 1784, he produced the first platinum crucible from platinum sponge made in this way.

**19th Century.** Around 1800, the accompanying metals in native platinum, which generally contains up to 80% Pt, were discovered. W. H. WOLLASTON (1766–1828) discovered palladium (initially also known as “new silver”) and rhodium; S. TENNANT (1761–1815) discovered iridium and osmium. At the same time, the existence of platinum as a true element was established. C. CLAUS (1796–1864) discovered ruthenium in 1844.

In 1823, J. W. DOEBRENER (1780–1849) first used the catalytic action of platinum in the gas lighter named after him. In about 1810, the process invented by W. H. WOLLASTON became established: dissolving the raw material in aqua regia, purifying it by precipitation of ammonium hexachloroplatinate,  $(\text{NH}_4)_2[\text{PtCl}_6]$ , and heating this strongly to form platinum sponge. In 1817, this led to the formation of Johnson, Matthey & Co., London [13], which laid the foundation of modern platinum technology.

Until the beginning of the 19th century, almost all platinum was obtained from the area now known as Colombia, which from 1739 to 1819 belonged to the Spanish Crown Dependency of New Granada. At this time, ca. 1 t/a of platinum was extracted. ALEXANDER VON HUMBOLDT was the most accomplished prospector and developer of noble-metal deposits

in New Granada (1819) and of the newly discovered platinum deposit in the Urals. In 1819, platinum was extracted from alluvial gold, but soon after this, the main production was switched to platinum placers with low gold content. In 1825, Russia became the primary producer of platinum. The minting of platinum coins in Russia in 1828–1845 necessitated an increase in production, which reached 3.5 t in 1843 [14–16]. Almost all Russian platinum ore was used for coinage (15 t total). Technology for the extraction and treatment of placer deposits had reached a high standard by this time.

After the closing of the refinery in St. Petersburg, which was associated with the local mint and produced a metal of ca. 97% platinum, 1.2% iridium, 0.5% ruthenium, 0.25% palladium, 1.5% iron, and 0.4% copper, the refining and working of Russian platinum ore were carried out almost exclusively in Western Europe. New companies for the refining and working of platinum were founded, including Desmoutis, Paris (1822); Baker & Co., New York (from 1904: Engelhard, Newark, New Jersey); Heræus, Hanau (1851); Siebert, Hanau (1881; from 1930 part of Degussa, Frankfurt); J. Bishop & Co., Malverne, Pennsylvania and others.

**20th Century** [17–20]. The platinum industry grew vigorously after 1880 due to increasing demands of the electrical industry, dentistry, and chemical technology. The primary consumer was the United States. In 1913, annual production of crude platinum reached 7 t. At this time, Russia began to make itself less dependent on other countries by constructing a modern platinum refinery and smelting point at Ekaterinburg (formerly Sverdlovsk). However, at the result of an ideologically negative attitude toward noble metals and a false estimate of their economic importance, platinum production was abandoned after the Russian Revolution.

The result was that, after World War I, Colombia once again became the largest platinum producer. The raw materials were exclusively alluvial deposits, which were ex-

tracted by panning, as they are even today. Almost all of the Colombian crude platinum was refined in the United States.

In 1925, production in the Urals was restarted. New alluvial deposits were discovered in Siberia. Also, mining of primary platinum became important. Today, a large proportion of the platinum group metals supplied by the CIS comes from sulfidic nickel deposits. For some decades, the Soviet Union has been one of the largest producers of platinum and especially palladium. Production figures are not available thus far. Estimates are approximate and are based on export figures.

During World War I, the demand for nickel increased, and Canada became an important producer of palladium and platinum, because nickel ores also contained platinum group metals. Since 1890, these ores have been extracted by the Mond Nickel Co. (since 1961, INCO, London), later allied with the International Nickel Co. of Canada. From 1925, platinum metals were produced in their own refinery in Acton in London. Another important producer of platinum is Falconbridge Nickel Mines in Toronto.

After World War I, worldwide demand could no longer be satisfied by Russia and other producers, and new sources were developed. In South Africa, the search was particularly well rewarded. Platinum and osmiridium were discovered at Black Reef (1888), Witwatersrand (1892), Great Dyk (Rhodesia, 1918), and later at Waterberg. The award of prospecting rights to private persons led to prospecting on a wide scale. A systematic geological survey of the Bushveld by J. MERENSKY was highly successful, leading to the discovery of platinum in the dunite pipes (1924) and subsequently in the stratiform platinum deposits known as the Merensky Reef (1925), the largest platinum deposit in the world.

This discovery brought about the greatest upheaval yet seen in the platinum market. It occurred during a period of both high demand (mainly for catalysts for ammonia oxidation) and high prices, the result being the foundation of about 50 producing companies. The primary platinum-bearing rock typical of

South African deposits presented the ore treatment and smelting technologies with completely new problems. Technical difficulties combined with a fall in the price of platinum led to a slump. The largest of the surviving companies formed Rustenburg Platinum Mines Ltd. in 1931, whose output reached 3 t/a during World War II.

After World War II, the Union of South Africa (Republic of South Africa) became the main producer of platinum. From 1969, all of the crude platinum produced by South Africa was refined by Johnson Matthey in England, although Matthey Rustenburg Refiners now refines considerable quantities of material produced in Rustenburg. Recently, some new producers have appeared in South Africa [e.g., Impala Platinum, Western Platinum (a subsidiary of Lonrho and Falconbridge), and Anglo-Transvaal Consolidated Investment (Anglovaal) and its subsidiary Atok Platinum Mines].

Figure 25.1 shows the history of world platinum output, and Table 25.1 lists the development of PGM production according to region.

## 25.2 Properties

**Atomic Properties** [21, 22]. The electronic structures of platinum group metals start from the inert gas structures of krypton and xenon:

Ru	[Kr] 4d <sup>7</sup> 5s <sup>1</sup>
Os	[Xe] 4f <sup>14</sup> 5s <sup>2</sup> 5p <sup>6</sup> 5d <sup>6</sup> 6s <sup>2</sup>
Rh	[Kr] 4d <sup>8</sup> 5s <sup>1</sup>
Ir	[Xe] 4f <sup>14</sup> 5s <sup>2</sup> 5p <sup>6</sup> 5d <sup>7</sup> 6s <sup>2</sup>
Pd	[Kr] 4d <sup>10</sup>
Pt	[Xe] 4f <sup>14</sup> 5s <sup>2</sup> 5p <sup>6</sup> 5d <sup>9</sup> 6s <sup>1</sup>

**Table 25.1:** Historical development of the production of platinum group metals according to region (other countries account for only 1–2% of world production) (in t/a).

	1800	1850	1900	1910	1920	1930	1940	1950	1960	1970	1975	1980	1985	1990
Colombia	1	<1	<1	<1	2	2	2	1	1	<1	<1	<1	<1	<1
Russia*	1	2	12	11	1	3	10	6	12	30	70	70	70	70
Canada			<1	<1	1	2	6	7	12	12	12	12	12	12
South Africa						2	2	4	20	50	90	120	120	130
United States			<1	<1	<1	<1	2	2	1	1	1	1	1	10
World	1	2	12	12	4	10	22	20	45	93	173	203	203	222

\*Estimated.

Two valence orbitals exist: an *s* shell and an inner *d* shell. The small energy difference between them means that the electron shells are filled in inconsistently, so that with some elements, one or both electrons from the outer 5*s* or 6*s* shells are taken up by the 4*d* or 5*d* shells.

Because of the small energy differences between the valence shells, a number of oxidation states occur. The following oxidation states are known in the compounds of platinum group metals (principal oxidation states in bold print):

Ru:	-2,	0,	+2,	+3,	+4,	+5,	+6,	+7,	+8
Rh:	-1,	0,	+1,	+2,	+3,	+4,	+5,	+6	
Pd:	0,	+2,	+3,	+4					
Os:	-2,	0,	+1,	+2,	+3,	+4,	+5,	+6,	+8
Ir:	-1,	0,	+1,	+2,	+3,	+4,	+5,	+6	
Pt:	0,	+2,	+4,	+5					

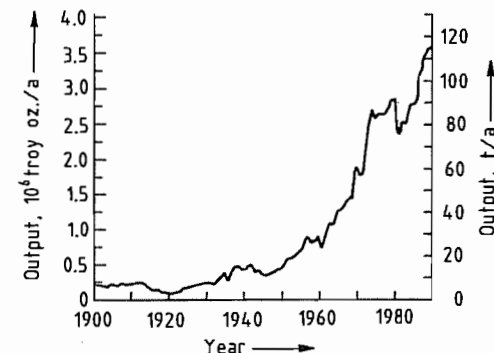

**Figure 25.1:** History of world platinum output (including Soviet sales to Western World).

The other properties typical of transition metals are very marked; for example, catalytic activity due to their readiness to change valence, formation of intermediate compounds with different reagents, color, paramagnetism due to unpaired electrons, and strong tendency to form complexes.

**Table 25.2:** Atomic and physical properties of the platinum group metals.

Property	Ru	Rh	Pd	Os	Ir	Pt
Atomic number	44	45	46	76	77	78
Relative atomic mass	101.07	102.90550	106.42	190.2	192.22	195.08
Abundance of major natural isotopes	101 (17.0%) 102 (31.6%) 104 (18.7%)	103 (100%)	105 (22.3%) 106 (27.3%) 108 (26.5%)	189 (16.1%) 190 (26.4%) 192 (41.0%)	191 (37.3%) 193 (62.7%)	194 (32.9%) 195 (33.8%) 196 (25.3%)
Crystal structure	hcp	fcc	fcc	hcp	fcc	fcc
Lattice constants at 20 °C						
<i>a</i> , nm	0.27058	0.38031	0.38898	0.27341	0.38394	0.3923
<i>c</i> , nm	0.42819			0.43197		
Atomic radius, nm	0.133	0.134	0.138	0.134	0.136	0.139
<i>mp</i> , °C	2310	1966	1554	3045	2410	1772
<i>bp</i> , °C	4050	3760	2940	5025	4550	4170
Specific heat at 25 °C <i>c<sub>p</sub></i> , Jg <sup>-1</sup> K <sup>-1</sup>	0.25	0.24	0.23	0.13	0.13	0.13
Thermal conductivity <i>λ</i> , Wm <sup>-1</sup> K <sup>-1</sup>	106	89	75	87	59	73
Density at 20 °C, g/cm <sup>3</sup>	12.45	12.41	12.02	22.61	22.63	21.45
Brinell hardness	200	101	52	250	172	50
Young's modulus <i>E</i> , N/mm <sup>2</sup>	475 785	379 058	121 251	559 170	528 072	169 909
Tensile strength <i>σ<sub>b</sub></i> , N/mm <sup>2</sup>	490.5	412	196.2	490.5	490.5	137.3
Specific electrical resistance at 0 °C, μΩcm	6.71	4.33	9.92	8.12	4.71	9.85
Temperature coefficient of electrical resistance (0–100 °C), K <sup>-1</sup>	0.004	0.0046	0.0038	0.0042	0.0043	0.0039
Thermoelectric voltage versus Pt at 100 °C <i>E</i> , V	+0.68	+0.70	-0.57		+0.66	

Comparisons within the group of platinum metals, also including neighboring elements, often give an insight into the relationship between electronic configuration and chemical properties.

Many properties show marked similarities along the two horizontal rows:

Ru ↔ Rh ↔ Pd ↔ (Ag)

Os ↔ Ir ↔ Pt ↔ (Au)

Also, the tendency toward complex formation and higher oxidation states is more marked in the row of heavy elements than in the row of light elements.

Vertical similarities between the elements also occur (e.g., in their behavior toward acids; (see Table 25.3):

Ru Rh Pd (Ag)

↓ ↓ ↓ ↓

Os Ir Pt (Au)

Similarities also exist in the following diagonal sequence, sometimes with ruthenium and iridium changing places:

Ru Rh Pd (Ag)

↓ ↓ ↓ ↓

Os Ir Pt (Au)

The chemical properties of the platinum group metals and the chemistry of their compounds fit less well into such a scheme than their physical properties.

All platinum group metals have several naturally occurring stable isotopes, with the exception of rhodium, which has only one.

**Physical Properties** [22–27]. Apart from their chemical inertness (Table 25.1), the platinum metals have a number of physical properties of great value for their industrial use. These include high melting point, low vapor pressure, high temperature coefficient of electrical resistivity, and low coefficient of thermal expansion. Table 25.2 lists atomic and crystal data and a physical properties of the platinum group metals.

**Chemical Properties** [28–33]. Table 25.3 shows the chemical behavior of platinum group metals toward various reagents. Resem-

blances are most clear within the two groups of elements. The aim is to quantify the reactions, so as to provide useful information when choosing construction materials or dis-

solving platinum group metals. Some combinations of reagents that can be used to dissolve these metals are also detailed later.

Table 25.3: Chemical resistance of the platinum group metals.

Reagent	Conditions	Temperature, °C	Pd	Pt	Rh	Ir	Ru	Os
Hydrochloric acid	36%	20	—	—	—	—	—	—
		100	•	—	—	—	—	•
Nitric acid	65%	20	●	—	—	—	—	•
		100	●	—	—	—	—	●
Sulfuric acid	96%	20	—	—	—	—	—	—
		100	•	—	•	—	—	—
		300	•	•	•	—	—	—
Hydrobromic acid	60%	20	●	•	•	—	—	—
		100	●	•	•	—	—	•
Hydroiodic acid	57%	20	●	—	—	—	—	•
		100	●	●	—	—	—	•
Hydrofluoric acid	40%	20	—	—	—	—	—	—
Phosphoric acid		100	•	•	—	—	—	●
Acetic acid	99%	100	—	—	—	—	—	—
Hydrochloric acid/chlorine	20%/saturated	20	•	•	—	—	—	—
		80	●	●	•	•	—	—
		100	●	●	•	•	—	—
Hydrochloric acid/bromine		20	●	•	•	—	—	—
		100	●	•	•	—	—	—
		100	●	●	•	•	—	—
Aqua regia		20	●	●	—	—	—	●
		100	●	●	—	—	—	●
		150	●	●	—	•	—	—
Hydrochloric acid/H <sub>2</sub> O <sub>2</sub>		20	●	—	—	—	—	—
		100	●	—	—	—	—	—
Hydrobromic acid/bromine	60%	100	•	—	●	—	—	—
		20	•	—	•	—	—	—
		20	•	—	•	—	—	—
Ethanol/iodine		20	•	—	•	—	—	—
		20	•	—	•	—	—	—
Sodium hypochlorite solution		20	•	—	•	—	—	•
		100	●	—	•	•	—	●
Sodium cyanide solution		20	•	—	—	—	—	—
		100	●	•	—	—	—	—
Copper(II) chloride solution		100	•	—	—	—	—	—
		100	•	—	—	—	—	—
NaOH melt	+ air	500	•	•	•	—	●	
KOH melt	+ air	500	•	•	•	—	●	
NaOH melt	+ air	800	•	•	•	—	●	
KOH melt	+ air	800	•	•	•	—	●	
KHSO <sub>4</sub> melt	+ air	440	•	—	•	—	•	
NaCN melt	+ air	700	•	•	•	•	•	
KCN melt	+ air	700	•	•	•	•	•	
NaCN/KCN melt (2:1)	+ air	550	•	•	•	•	•	
Chlorine, gaseous	dry	20	•	•	—	—	—	—
	moist	20	●	•	—	—	—	•
Bromine liquid	dry	20	●	•	—	—	—	•
	moist	20	●	•	—	—	—	•
Iodine, solid	dry	20	—	—	—	—	—	•
	moist	20	•	•	•	—	—	—
Fluorine, gaseous		20	—	•	—	—	—	—
Hydrogen sulfide, gaseous	moist	20	—	—	—	—	—	—

— Mass loss < 0.01 mg cm<sup>-2</sup> h<sup>-1</sup>; ideal as construction material  
• Mass loss ca. 0.1 mg cm<sup>-2</sup> h<sup>-1</sup>; limited use as construction material  
● Mass loss ca. 1 mg cm<sup>-2</sup> h<sup>-1</sup>; limited use for dissolution processes  
● #Mass loss 10 mg cm<sup>-2</sup> h<sup>-1</sup>; suitable for dissolution processes

## 25.3 Occurrence

### 25.3.1 Abundance [10, 30, 34–37]

The abundance of platinum group metals (PGMs), which occupy an intermediate position based on their atomic number and atomic weight, would be expected to be 10<sup>-4</sup> ppm, based on the mode of formation of atomic nuclei [38]. They are concentrated in planetary regions, reaching ca. 30 ppm in the earth. Considerable fractionation has taken place in the earth's interior, due mainly to the siderophilic chemical character of PGMs, so that virtually the entire mass of PGMs is in the earth's metallic core. The siliceous lithosphere is estimated to contain 0.05–0.5 ppm.

On theoretical grounds, the PGMs in the earth are assumed to contain ca. 20% each of platinum, palladium, ruthenium, and osmium, and ca. 6% each of rhodium, and iridium. In the case of ruthenium and especially osmium, these values are not reflected in the deposits mined to date.

### 25.3.2 Ores and Their Origin

[10, 30, 31, 34, 39–46]

The PGMs in the lithosphere have been transferred from the earth's interior. Tectonic movements of the earth's crust, followed by the eruption of magma, have led to their presence in regions close to the surface. Solidification processes, differences in melting point and density, gas emissions, convection due to heat, and the flow and eruption of magma, have all produced concentration and separation effects, mainly in marginal zones. Chemical interaction with high-temperature silicate layers, especially their sulfide, arsenide, antimonide, selenide, and telluride components, has also played a major role. Almost invariably, the platinum group elements have separated from ultrabasic magmas. Norite (Mg–Fe–Ca–Al silicate) contains mainly sulfidic intrusions, whereas those in dunite (Mg–Fe silicate) are mainly sulfide free. Platinum and palladium (often with nickel, copper, chro-

mium, etc.) sometimes undergo hydrothermal reactions with chlorides in the earth's interior. All of these processes have led to the formation of the primary deposits of platinum-bearing rock. Workability depends on many factors—concentration of platinum metals, accessibility, size of deposit, value and potential uses of accompanying materials—and is economical in only a few cases.

When primary deposits are altered and transported by the natural action of the hydrosphere and atmosphere, secondary deposits, also known as placers or alluvial deposits, are formed. Mechanical concentration of the heavy constituents by flowing water takes place, together with chemical dissolution and reprecipitation of the platinum metals. Recently, hydrothermal processes have been shown to be considerably more important than was at first thought. Alluvial deposits usually originate from dunite.

The platinum metals occur in a large number of minerals. Workable ore deposits contain mainly sperrylite (PtAs<sub>2</sub>), cooperite (PtS), stibopalladinite (Pd<sub>3</sub>Sb), laurite (RuS<sub>2</sub>), ferroplatinum (Fe–Pt), polyxene (Fe–Pt–other platinum metals), osmiridium (Os–Ir), and iridium platinum (Ir–Pt). These minerals are associated with particular carrier materials, which are often valuable themselves (e.g., iron pyrites, nickel iron pyrites, or chrome iron ore).

The minerals are seldom present in an exact stoichiometric ratio. This is true of the platinum group metals themselves, which are nearly always present in varying ratios, and of the accompanying elements with which they form compounds or alloys. Isomorphism opens up the possibility of further variations. Isomorphous intercalations make up a larger part of the economically workable reserves. Electron probe microanalysis (EPM) has enabled a large number of definite compounds and intermetallic phases to be identified where mixtures or homogeneous solid solutions had formerly been assumed to be present.

Outside of true deposits, platinum group metals are widely distributed in very high dilution as isomorphous combinations with vari-

ous metals such as nickel, cobalt, and copper, mainly in their sulfides.

### 25.3.3 Primary Deposits [47–63]

The dunite bodies in the Urals are the most important of the old Russian platinum deposits, either as primary deposits or as material for the formation of secondary deposits. The only important primary deposit is at Nishnij-Tagil, which is mined in many locations. It is a projectile-like intrusion of dunite through the earth's crust, which appears to reach a depth of more than 100 km and has an area on the earth's surface of 25 km<sup>2</sup>. Platinum metals are concentrated in dunite in the form of striæ, lenses, nests, and pillars. They are present mainly as polyxene (Fe–Pt), iridium-rich platinum, and osmiridium, and are often associated with serpentine or chromite. Most of the platinum has been obtained from ores with a platinum metal content of 10–20 ppm. However, ores containing 400 ppm are found in some places. In the total dunite body, the average platinum content is ca. 0.1 ppm. Other dunite bodies in this region are not economically important either for their metal content or for the extent of the deposit.

The dunite pipes at the eastern border of the South African Bushveld have a similar origin to the Russian dunite bodies and are of the same base material. The platinum-bearing core of this narrow intrusion often has a diameter of 20 m or less. Veins are rarely present. The excavations at Driekop and Onverwacht are the most well known. Mining is difficult. Since the exploitation of the Merensky Reef, they can be mined economically only in certain cases. Platinum group metals are sometimes present in the metallic state and sometimes as sperrylite in association with chromite. Platinum concentrations are 1–200 ppm, and locally higher.

The richest and scientifically most interesting deposits, although small in extent, are the quartz lodes of Rietfontein on the Waterberg in the Western Cape Province. Owing to their hydrothermal origin, the platinum metals are present in native form, accompanied by hema-

tite. The PGM content of the ore often reaches almost 5000 ppm. Deposits of similar structure have not been found elsewhere.

The largest known primary deposit of PGMs is the South African Bushveld Complex, with a total extent of ca. 250 km from north to south and 480 km from east to west. This oval-shaped zone was apparently produced by an outflow of PGM-bearing norite magma into a flat basin. At the bottom of this, the minerals sperrylite (PtAs<sub>2</sub>) and cooperite (PtS) have separated along with iron pyrites, nickel pyrites, copper pyrites, and chromite. The relatively thin PGM-bearing layers at the edges of the outflow near the earth's surface are mined. These are in both the oxidation and the sulfidic zones, and begin at a depth of < 100 m. The working depth extends to almost 1000 m. The platinum content of the mined ore is 320 ppm. Palladium is less important than platinum; all the platinum group metals are present. The deposit has great economic importance owing to its consistent quality, ease of extraction, and large extent. The Bushveld is mined at the western and southwestern edges (Rustenburg region) and the eastern and northeastern edges (Lydenburg region) (Figure 25.2) in two wide areas. The Bushveld is also the world's largest chromium and vanadium deposit, and has large deposits of nickel, cobalt, copper, iron, tin, fluorspar, and alusite, magnesite, and asbestos.

These deposits were discovered in 1925 by the geologist HANS MERENSKY (1871–1952) [17]. He laid the foundations for the most important phase in the development of platinum extraction by his wide-ranging prospecting work and fundamental observations on the geology of the Bushveld. The most important areas of PGM deposits in the western and eastern part of the Bushveld are known as the Merensky Reef. Not far from these deposits lie the less important Platereef and the UG 2 Reef (Upper Group Reef), which has recently increased in importance due to its very high rhodium content in many places. This metal is in great demand and therefore very expensive.

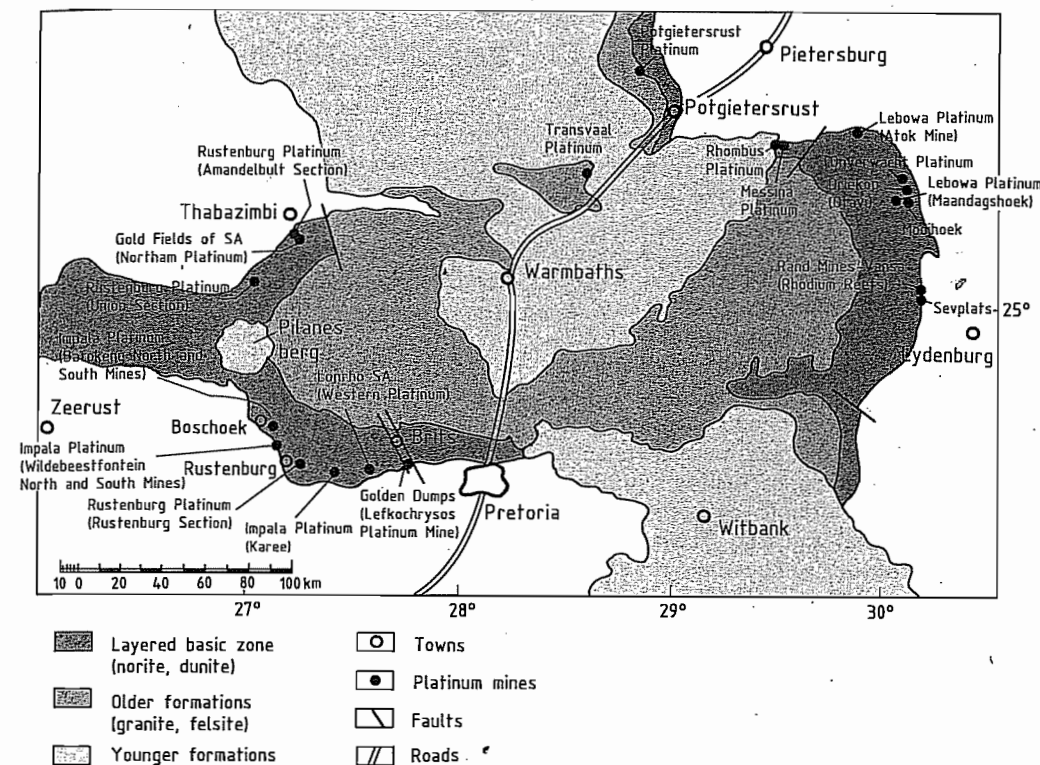

Figure 25.2: Geology and platinum mines of the Bushveld Complex.

The UG 2 reef is a chromite layer running parallel to the Merensky Reef, but somewhat deeper [64, 65].

Some examples of small deposits include the Black Reef in the Bushveld and, a few hundred kilometers north, the Great Dyk Mine in Zimbabwe.

The Stillwater deposit in Montana, United States is similar in origin and structure to the Bushveld deposit. However, PGM separation occurred at the boundary zone of a subterranean magma intrusion resembling a sloping lens. This deposit extends for a length of ca. 80 km. The total PGM content, with high levels of palladium and rhodium, is higher than that of the Merensky Reef deposit.

The nickel sulfide deposits of the Sudbury, Ontario district of Canada, yielding iron pyrite, FeS<sub>2</sub>, pentlandite, (Fe, Ni)<sub>9</sub>S<sub>8</sub>, and chalcopyrite, CuFeS<sub>2</sub>, are today important sources of platinum, and more especially of palladium.

These deposits are associated with noritic magma. The average platinum metal content of the untreated ore is only ca. 0.3 ppm, with a nickel content of ca. 2%. However, the treatment process for the nickel ore concentrates the platinum metals to > 50 ppm without extra cost.

Palladium-containing sperrylite (Pt–PdAs<sub>2</sub>) and stibiopalladinite (Pd<sub>3</sub>Sb) are present in the ores, and the platinum group metals also form isomorphous mixtures with the heavy-metal sulfides. During formation of these deposits, the sulfides of nickel and copper acted as collectors. The large reserves in Noril'sk in Central Siberia, which have a high palladium content, are similar to the Canadian deposits with regard to composition and ore treatment methods. Some lead–zinc ores [e.g., in the Rammelsberg (Harz) mountains], contain small amounts of platinum and palladium.

Comparisons with other metals indicate that PGM reserves may exist in the Antarctic [66]. The magma flow in the South African Bushveld occurred in an early geological epoch (Cambrian—more than  $2 \times 10^9$  years ago), when the African and Antarctic continents were still part of Gondwanaland.

### 25.3.4 Secondary Deposits

Alluvial deposits are typical reserves of this type. They were produced in recent geological epochs (Quaternary Holocene) by weathering and washing of primary deposits, mainly dunitic, which resulted in concentration of the more resistant and heavier components (i.e., the metallic and arsenidic platinum minerals, gold, magnetite, chromite, cassiterite, zircon, and granite) in clay and sand. These oxidation zones are often located above the primary deposits. River placers are formed from the alluvial deposits by the erosive action of water, to yield so-called black sands. However, typical nuggets (mainly small granules but also sizable metallic lumps weighing up to several kilograms) seem to have been formed mainly by mechanical agglomeration, usually involving chloridic dissolution and reprecipitation. Very old deposits that formed conglomerates by adhesive action are termed fossil placers. The platinum metal content of secondary deposits varies over a wide range. Deep alluvium and river headwater placers are the most productive.

For easily washable sand, a PGM content of 0.05 ppm is economic. Before World War I, the PGM content of economic deposits was ca. 2 ppm, but today it is much lower. More platinum metals are recovered from river placers than from alluvial deposits.

Secondary deposits occur mainly in the Urals, Siberia, Colombia, and Ethiopia. Often, the recovery of gold and platinum metals from such deposits is so interdependent that sometimes one metal, and sometimes the other, is the main product. Osmiridium is obtained mainly in Alaska and in the Witwatersrand of South Africa, along with secondary deposits of gold.

### 25.3.5 Recovery of Secondary Platinum Group Metals [67–70]

Platinum metals not only are extracted from ore but, due to their high value, are also recovered from a wide range of industrial residues. These residues are of variable composition and quality, and recovery plants must be very flexible.

Often, the recovery operation is included in the sales contract for semifinished and finished goods, so materials are sent directly for recovery and do not appear on the raw materials market. For regular customers, accounts are kept of the weights of noble metals involved. The supply of material is facilitated, and risks due to price variation are minimized.

**Metallic Materials.** Large quantities of metallic materials in the form of used platinum rhodium gauze catalysts result from the oxidation of ammonia. These catalysts must be reprocessed chemically after 3–18 months of use. At present, ca. 50 t of Pt–Rh is bound up in these gauzes. The Pd–Au gauzes used to recover Pt–Rh vaporized in ammonia oxidation plants are also recycled.

The glass industry generates large quantities of defective components for chemical recovery (e.g., from melting vessels and other equipment).

Spinnerets from textile fiber manufacture must normally be replaced after about one year of operation owing to erosion of the holes.

Defective laboratory equipment, mainly crucibles and dishes, makes a considerable contribution, but chemical apparatus components are of little significance.

Considerable quantities of platinum-rhodium scrap are provided by the electrical measurement industry, mainly in thermocouple components. Other residues from the electrical and electronic sectors include electrical contacts, heater elements, and electronic components.

Manufacture of fountain pen nibs yields residues in the form of small spheres or dust that can contain ruthenium, osmium, iridium,

rhenium, tungsten, molybdenum, tantalum, nickel, and cobalt as alloy components. Treatment of these materials is among the most difficult of all separation techniques.

**Dross.** Waste materials include slag, ash, furnace residue, corrosion residue from equipment, and precipitation residue. Catalyst residues of poorly defined composition are also included. The PGM content of these materials is usually low; they are extremely variable and usually nonmetallic.

**Supported Catalysts [68].** Large quantities of platinum group metals must be recovered from spent catalysts. The most important of these, both in quantity and in value, are the heterogeneous catalysts used in the petroleum industry, especially in reforming processes, where  $> 50$  t of platinum is bound up worldwide. The lifetime of these catalysts is 4–8 years. Residues usually contain 0.3–0.7% platinum on  $\gamma$ - $\text{Al}_2\text{O}_3$ , and usually also include palladium, rhodium, iridium, and rhenium, which must also be recovered. The other large-scale processes in the petroleum industry—hydrofining and hydrocracking—yield palladium and platinum catalysts on aluminum silicate carriers.

Another source of material for recovery of platinum metals is spent automobile catalytic converters [67–69]. However, the PGM content is low (2 g per unit), and the units are enclosed in steel sheet and widely scattered. Collection and treatment are therefore difficult. A satisfactory and economical solution to this problem has yet to be found. In Germany, collection logistics are coupled to the recycling of automobiles.

The chemical industry produces considerable amounts of palladium catalysts on carbon carriers, often in a moist state that presents sampling problems. Similar residues come from platinum-carbon, rhodium-carbon, and  $\text{PtO}_2$  catalysts, although these are sometimes unsupported. Platinum asbestos, which was formerly used widely in sulfuric acid production, is now of very little importance.

**Solutions [67].** Amounts of liquid residues from homogeneous catalysts used in the oxo process (hydroformylation) have increased relatively rapidly. The rhodium content of the organic solvents or oily process residues is between 50 and 1000 ppm. Sometimes, these organic solutions contain iridium, ruthenium, or palladium. Aqueous residues, especially homogeneous catalysts containing rhodium, are currently being produced in increasing quantities.

The electroplating industry yields exhausted electrolytes that cannot be regenerated. The most important of these contain tetranitroplatin(II), rhodium(III) sulfate, and rhodium(III) phosphate.

Finally, the processes used for separating the platinum group metals also produce waste solutions that must be reclaimed (e.g., mother liquor from crystallization). These operations form part of the separation process.

**Radioactive Residues.** An as-yet unsolved problem is the treatment of radioactively contaminated platinum equipment from chemical laboratories and processes.

Fission of  $^{235}\text{U}$  in nuclear power stations produces considerable amounts of platinum group metals; one tonne of spent reactor fuel contains 1.2 kg of palladium, 0.5 kg of rhodium, and 2.3 kg of ruthenium [70].

However, the radioactivity of the material has not permitted the commercial use of this PGM source until now [71]. The most important PGM isotopes in spent reactor fuel are:  $^{107}\text{Pd}$  ( $t_{1/2} 7 \times 10^6$  a),  $^{102}\text{Rh}$  ( $t_{1/2} 3$  a), and  $^{106}\text{Ru}$  ( $t_{1/2} 1$  a).  $^{107}\text{Pd}$  is a very low-energy  $\beta$ -emitter, which would not exclude its use in many major applications; alternatively, it may be removed by isotope separation. The active isotopes of rhodium and ruthenium will have decayed to background levels after intermediate storage of ca. 30 years.

### 25.3.6 Reserves and Resources

**Natural Reserves.** Data concerning reserves (discovered by prospecting and having assessable economic value) and resources (which in-

clude additional supposed deposits and those with no current economic value) are very dependent on the time prospecting was carried out, and also on technical and economic parameters.

For platinum group metals, the current estimate of workable deposits is 70 000 t [44, 72, 73], 20 years ago, a figure of about one-third of this was assumed [74].

World reserves of the individual metals can best be estimated from the observed compositions of the deposits (Table 25.4) and the total amounts of PGMs that they contain (Figure 25.3). This does not include osmiridium, which usually occurs with gold.

**Industrial Residues.** Industrial residues have considerable potential for the supply of platinum group metals, in addition to their extrac-

tion from ore. In most sectors, the possibilities are now fully exploited. In others, recovery is difficult because of the low PGM contents of the waste materials (e.g., certain catalysts). Economic recovery is also difficult when small PGM-containing components are widely distributed (e.g., in electronics).

In particular, no satisfactory solution has been found to the problem of collecting used automobile exhaust catalysts. In 1991, more than 7 t of platinum was recovered from this source in the United States and Europe and about 0.5 t of rhodium in the United States [224].

A total of ca. 1 t/a of rhodium is currently produced worldwide in nuclear power stations. Some of this is placed in intermediate storage, and some in final repositories.

Table 25.4: Relative proportions of platinum group metals in selected deposits, and their grades.

	Bushveld complex		South Africa Plat Reef	Sudbury, Canada	Noril'sk, CIS	Colombia	Stillwater, United States	Average
	Merensky Reef	UG 2 Reef						
Platinum, %	59	42	42	38	25	93	19	45
Palladium, %	25	35	46	40	71	1	66.5	30
Ruthenium, %	8	12	4	2.9	1		4.0	5
Rhodium, %	3	8	3	3.3	3	2	7.6	4
Iridium, %	1	2.3	0.8	1.2		3	2.4	1
Osmium, %	0.8		0.6	1.2		1		< 1
Gold, %	3.2	0.7	3.4	13.5			0.5	
Grade, g/t	8.1	8.71	7-27	0.9	3.8		22.3	

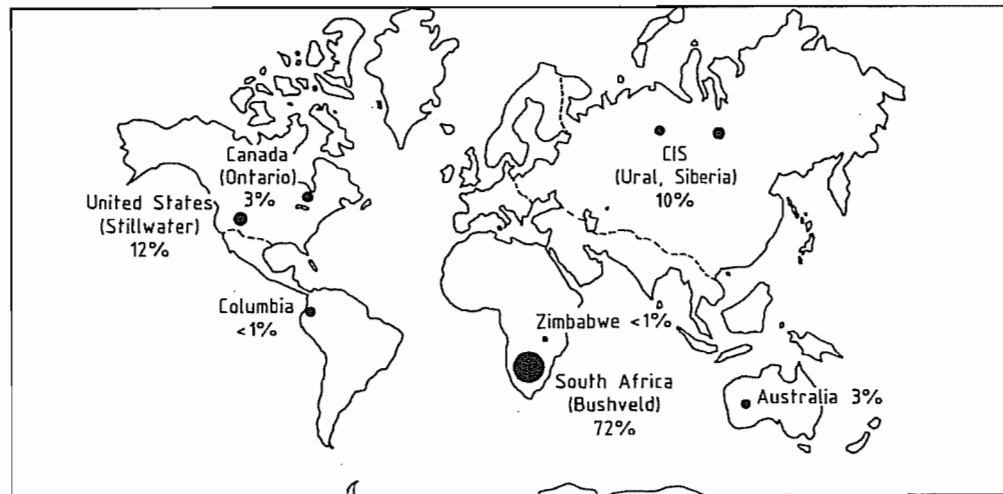

Figure 25.3: World platinum group metal reserves (total 70 000 t).

## 25.4 Mineral Dressing

### 25.4.1 Alluvial Platinum Deposits

[5, 10, 19, 29-31, 34, 39, 41-46, 75-83]

Gangue materials must normally be removed from the platinum-bearing placer deposits. Some deposits are extracted by subsurface mining.

Hydraulic classification can be carried out by hand washing with simple equipment, such as shovels, sieves, and troughs. This was the most common method of treating the Colombian deposits and is still used today. More modern methods involve rotary sieves, troughs, and perforated boxes with running water or water jets.

The most economical process is dredging river placers. This is a simple earth-moving technique linked with a natural inexhaustible water supply. Large installations have capacities of several thousand tonnes of sedimentary material per day, with a water consumption of ca. 10 times this figure. Aboard the dredger, deposits are treated mainly by gravity concentration with sieves and sedimentation equipment, using stirrers, thickeners, washing boxes, etc.

The last stage of concentration is often magnetic separation, with various field strengths used to separate magnetite, ferroplatinum-containing minerals such as chromite, and nonmagnetic components into fractions. Often, a final hand washing is carried out. In some types of deposit, gold particles or gold-containing platinum particles can be separated as amalgam from the platinum concentrate. Another process involves concentrating the platinum metals chemically by dissolving the other components in nitric acid. The concentrates so produced can contain up to 90% platinum group metals. These can be used directly by refineries.

A problem may occur with high losses of platinum carried out as very fine metal from the gravity separation process, often exceeding the amount of the product itself. Losses can be reduced to some extent by recycling the

lighter fraction during hydraulic classification of the platinum deposits.

### 25.4.2 Primary Deposits [44, 54, 64, 65, 83, 84]

The treatment of platinum-bearing rock, which is always supplied in lump form from primary deposits, consists of an initial size reduction by crushing and grinding, usually wet grinding.

After discovery of the South African primary deposits in the Merensky Reef, attempts were initially made to treat this platinum-bearing rock by the methods used for alluvial deposits. Many processes were investigated including gravity concentration, flotation, and metallurgical and chemical processes, such as chloride formation by calcining the powdered ore at 500-600 °C in the presence of sodium chloride. The results were unsatisfactory.

The modern process for the winning of PGMs from sulfide ores is shown in Figure 25.4. Ground ores from the workable oxidation zone, which contain the platinum metals in native form, are first subjected to gravity concentration on cordyroy and James tables or by hydrocyclones, to separate the metallic particles from the platinum-bearing minerals and give a concentrate with a high PGM content that can be processed quickly with low losses.

Flotation is then carried out to remove the gangue from the sulfidic minerals, which are also associated with arsenidic and sulfidic platinum metal compounds and very finely divided elemental platinum metals. This concentrates the platinum group elements by a factor of 10-50. After filtration with a rotary filter, the platinum metals in the flotation concentrate are present at a total concentration of several hundred parts per million, along with a small percentage of sulfur, copper, nickel, and iron.

This sequence of process steps is not suitable for all types of deposits and production equipment. Magnetic or electrostatic separation can sometimes be carried out before the smelting operations.

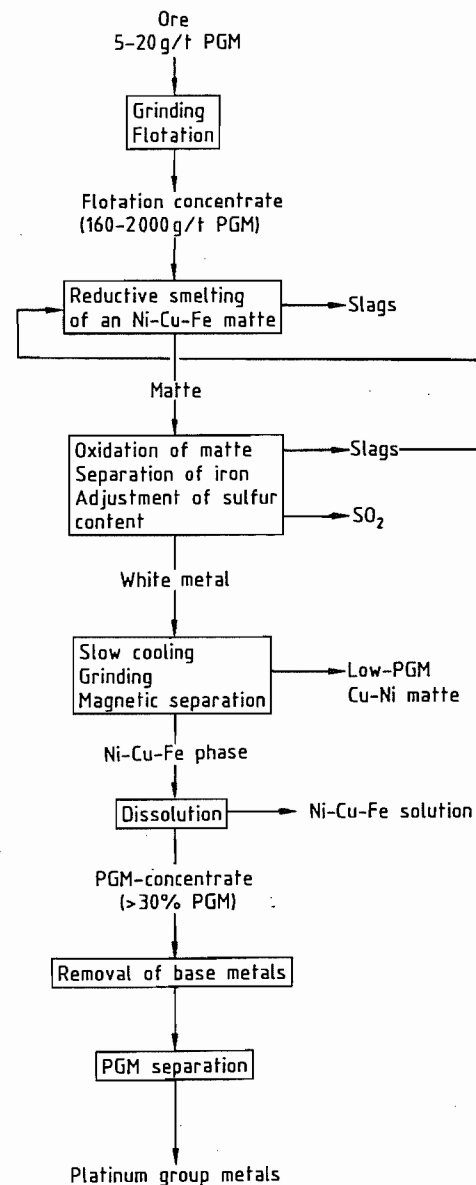

Figure 25.4: Winning of platinum group metals from sulfide ores.

The pelletized material is smelted in a shaft furnace to form a copper-nickel matte. Oxygen is then blown into the converter to oxidize the iron sulfide selectively to iron oxide, which forms a slag. These two processes concentrate the platinum metals in the copper

nickel matte to > 0.1%. The blowing operation is controlled so as to give the correct sulfur content for the next concentration stage. In this recently developed, slow-cooling matte separation process, a finely crystalline, homogeneously distributed Ni-Cu-Fe phase, in which the PGMs are concentrated in high yield, is formed in the almost iron-free copper sulfide matte phase (see Section 12.4.4). The product is ground, and the PGM-containing magnetic Ni-Cu-Fe phase is recovered from the PGM-free matte by magnetic separation. Base metals are then removed by treatment with sulfuric acid and oxygen. The concentrate obtained contains 50–90% PGMs. The next stage is to separate the platinum group metals from one another.

The older pyrometallurgical process is time consuming and does not give such good separation. After air blowing the iron, the converter matte produced is smelted with sodium sulfide and separated into copper-containing and nickel-containing layers (tops and bottoms process). The nickel-containing material is roasted and then reduced in a reverberatory furnace to give PGM-containing impure nickel. The platinum group metals are recovered from the anode slime produced during electrorefining. A method of this kind is apparently still used to treat sulfidic PGM deposits in the Urals.

Problems arise during treatment of the high-chromite ores of the UG 2 reef by the sulfidic route; these are therefore often mixed with ore from the Merensky deposit. A process that shows great economic promise for the future is to smelt a metallic concentrate directly from the ore in a plasma furnace [64]. Both types of ore are suitable, although the chromite-containing ore is better.

### 25.4.3 Nickel Ores [61, 62]

In the processing of sulfide nickel ores, which always contain copper, the platinum group metals follow the nickel in the smelting process. When the crude copper is electrorefined, the amount of PGMs obtained in the anode slime is very small.

When nickel is electrorefined, the platinum group metals remain behind in the slime formed at the nickel anode. The base metals and the silver are dissolved by acid treatment, giving a concentrate that contains ca. 70% platinum group metals and differs from the nickel anode slime obtained from platinum ores of the Merensky reef in having an appreciably higher palladium content. Also, the concentration of platinum group elements in the unrefined nickel is about 100 times lower than that in the nickel obtained from platinum ore from the Merensky or UG 2 reef.

When crude nickel is refined by the carbonyl process (see Section 12.6.3) residues with a lower PGM content are obtained. These are suitable for concentration by smelting under reducing conditions with lead(II) oxide and sodium carbonate. The lead is driven off, and the silver is dissolved and removed. These concentrates are of high enough quality for separation into individual metals.

The treatment of PGM-containing copper anode slime obtained from nickeliferous pyrrhotite is a long and costly process. The metals copper, selenium, tellurium, arsenic and antimony must first be removed (e.g., by forming their sulfates in a high-temperature process), followed by dissolution or by producing slags via smelting in the presence of potassium nitrate with an air blast. This yields so-called Doré metal. The platinum group metals are then concentrated in the anode slime produced in the subsequent silver electrorefining process.

Copper ores can also contain very small amounts of platinum group metals. These appear in the copper anode slime during copper electrorefining.

### 25.4.4 Metal Scrap

A high proportion of the metallic waste from used equipment and from semifinished products can simply be dissolved without any prior treatment. These types of material include crucibles, dishes, thermocouple elements, gauze catalysts, and fiber spinneret nozzles.

Massive materials such as heavy-gauge sheets or bars should be size reduced by crushing or machining to produce swarf. For the highly refractory metals of the platinum group (Rh, Ir, Ru, and Os) and their alloys, mechanical methods are usually not sufficient to produce a surface susceptible to dissolution. This is also true of platinum alloys with > 30% rhodium or 20% iridium. In these cases, alloys of platinum or palladium, which can be dissolved more easily, are preferable.

Very highly dispersed noble-metal black, which is often more soluble, is obtained by alloying the highly refractory platinum metals with base metals and then dissolving the latter out. The noble-metal black must not be heated, or the optimum surface properties for the solution process would be adversely affected. Suitable alloying elements include copper, lead, nickel, zinc, aluminum, bismuth, and silver.

Commercial powdered rhodium and iridium also cannot be dissolved by direct chemical means, but they can be treated with chlorine at ca. 500–600 °C to form chlorides (also insoluble), and these can be reduced at low temperature (e.g., by hydrogen or by hydrazine in aqueous suspension) to produce finely divided blacks that can be dissolved in hydrochloric acid-chlorine.

Concentrates of platinum metals often contain oxides that are less soluble in oxidizing acid mixtures than the metals. In these cases, the material must first be reduced by heating in a hydrogen atmosphere or by treating with aqueous hydrazine hydrate at ca. 80 °C. For rhodium oxides, solutions must be highly alkaline and at their boiling point.

### 25.4.5 Dross [85–89]

If platinum metals cannot be separated by chemical or mechanical methods from accompanying nonmetallic materials, as is usually the case with low-grade waste, pyrometallurgical processes must be used (as in ore treatment).

The most convenient and long-established pyrometallurgical process for low-grade waste



is smelting with lead in a shaft furnace to produce slag. Materials containing silver and gold are treated in this way. The lead acts as a collector for the platinum group metals. The presence of gold and silver also considerably affects the distribution equilibrium of the platinum group metals in the melt. In the lead shaft furnace, some of the high-melting noble metals rhodium, iridium, and ruthenium separate as so-called furnace shows. When the lead is oxidized and removed as litharge, most of the Rh, Ir, and Ru (so-called bottom metals) precipitates from the increasingly silver-rich alloys. Considerable amounts of rhodium and iridium pass into the shaft furnace slag and are lost. Ruthenium and particularly osmium are lost in large amounts in flue dust and waste gases.

When the gold-silver alloy from the above process is electrorefined to obtain silver, gold and the platinum group metals remain in the anode slime. If this consists mainly of gold, it is converted to pure gold by Wohlwill electrolysis, in which platinum and palladium are concentrated in the electrolyte, and silver chloride and the remaining platinum group metals in the anode slime. Alternatively, the silver can be dissolved from the gold-silver alloy by nitric acid to form silver nitrate, which is purified by thermal decomposition of the accompanying nitrates; the platinum group metals remain in the water-insoluble oxide residue.

All the concentrates mentioned above can be dissolved, and the individual platinum group metals obtained from these solutions.

#### 25.4.6 Supported Catalysts [68, 69, 90-93]

Spent, inactive catalysts consisting of platinum metals supported on active carbon, or carrier-free noble-metal catalysts that have become coated with organic residues, are concentrated by combustion. These materials are sometimes spontaneously flammable. When they are being burned, strong air currents are suppressed to prevent dust losses. If the result-

ing ash contains platinum metal oxides, these are reduced to the metal.

Catalysts with incombustible carriers insoluble in acid and alkali (e.g.,  $\gamma$ - $\text{Al}_2\text{O}_3$ , silica gel, asbestos, and zeolites) can often be treated with oxidizing acid, but the noble metals dissolve completely only in the absence of organic residues (especially tarry matter) and if the carriers are very porous. Otherwise, the platinum metals must be concentrated by the lead shaft furnace process (see Section 25.4.5).

Reforming catalysts consist of  $\gamma$ - $\text{Al}_2\text{O}_3$  impregnated with platinum, platinum-rhodium, platinum-iridium, or platinum-rhenium. This carrier material is soluble in acid and alkali, and is dissolved (e.g., in hot sulfuric acid or hot caustic soda solution) leaving the noble metal as an insoluble residue. However, small, but not negligible, amounts of noble metal also go into solution. Moreover, sulfidic impurities in the catalyst can lead to the release of toxic hydrogen sulfide. Other practical processes are dissolving the catalyst in sodium carbonate solution (usually at 220 °C in a pressurized reactor), or sintering with sodium hydroxide or sodium carbonate. Carbon and other products of the breakdown of mineral oil in the spent catalyst must be burned off before treatment with acid or alkali, because these materials interfere with the filtering of the platinum metal concentrate.

Spent automobile exhaust catalysts can be processed at high temperature in a plasma or a submerged arc furnace. In the former, a plasma is produced between an electrode and the molten feed material. The energy of recombination of the plasma is released into the melt. In the resistance furnace, slag serves as the electrical resistance in which heat is produced. In both processes, the oxide carrier is melted with or without addition of a flux of lower the melting point. Iron or copper is added as a collector, forming a metallic melt that takes up the platinum group metals. The concentration of PGMs can reach 20%.

#### 25.4.7 Treatment of Solutions [67, 94, 95]

In homogeneous catalysis, high-boiling distillation residues are usually produced that contain no valuable materials apart from rhodium and sometimes ruthenium. These residues can be carefully burned, and the ash treated by wet chemical processes. Other techniques for recovering rhodium have been suggested (i.e., liquid-liquid extraction, reductive precipitation of the metal, and pyrolytic hydrogenation). A process used in industry, especially for the treatment of rhodium-containing oily residues from oxo synthesis, is precipitation of acid-soluble rhodium telluride by reacting the organically bound rhodium with tellurium. This process is notable for the high efficiency of rhodium recovery.

The methods used to produce concentrates from a variety of aqueous wastes are to a large extent the same as those used for the internal recycling of platinum metals in the solutions produced in metal winning processes (see Section 25.6.8).

### 25.5 Dissolution Methods

[34, 46]

Whether separating platinum group metals or producing compounds and catalysts, the usual starting point is an aqueous solution.

Most raw materials can be dissolved in oxidizing acids. Dissolution can be carried out at atmospheric pressure, or at elevated pressure to obtain higher temperature. Convective or microwave heating can be used.

Highly refractory raw materials, such as rhodium and iridium powder, can be converted into a highly dispersed form, by chlorination at ca. 500 °C, followed by reduction with hydrogen at 100-200 °C or hydrazine in aqueous suspension. Alternatively, rhodium can be oxidized to  $\text{Rh}_2\text{O}_3$  and then reduced.

In some cases, melt processes at higher reaction temperature must be used. A review of the dissolution properties of platinum group metals is given in Figure 25.5 and Table 25.3.

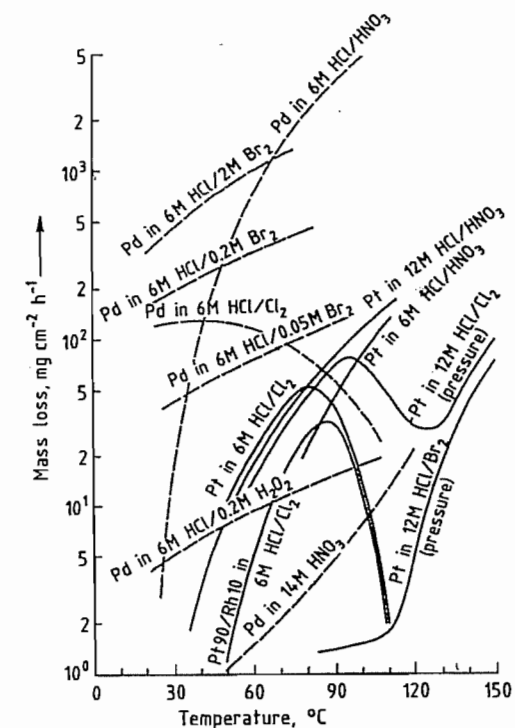
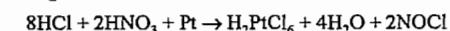

Figure 25.5: Rate of dissolution of platinum and palladium in oxidizing acids.

The cost of the dissolution step is an appreciable fraction of the cost of the entire process if many small amounts must be dissolved individually for the determination of value; therefore, the choice of method is important.

#### 25.5.1 Dissolution in Aqua Regia

The following reaction takes place in aqua regia:



as does the following decomposition:

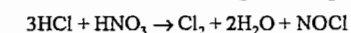

The highest rates of dissolution occur at the boiling point of aqua regia. The rate depends only slightly on acid concentration between 6 and 12 M, and is virtually unaffected by the presence of dissolved platinum group metals.

The aqua regia method is preferred for compact metallic platinum and high-platinum alloys (sheet, wire, turnings, etc.). The reac-

tions must be carried out in a sealed apparatus to prevent loss of material by splashing and mist formation. Before the next stage of treatment, nitric acid must usually be removed by concentration with the addition of hydrochloric acid.

To suppress side reactions, the reactants must not be allowed to boil too violently, although maintaining them at the boiling point and use of 6 M acid offers the most convenient method of sustaining consistent reaction conditions. To avoid boiling over, especially during heating, the initial charge of nitric acid should be added slowly and evenly to boiling hydrochloric acid. This method should also be used when aqua regia is added to replace spent acid.

Finely powdered material also tends to cause boiling over. To avoid a violent reaction when dissolving palladium-rich alloys, dilute acids should be used.

### 25.5.2 Dissolution in Hydrochloric Acid–Chlorine

In the reaction between platinum and a solution of chlorine in hydrochloric acid

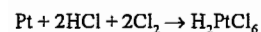

the dissolution rates for platinum and platinum-rich alloys have a maximum in the range 80–90 °C (Figure 25.5). As the boiling point of hydrochloric acid (110 °C) is approached, the rate of reaction decreases rapidly, increasing again at higher temperature. For palladium, the rate of dissolution is considerably higher.

For these dissolution reactions, 6–8 M hydrochloric acid is preferred since, in this concentration range, both the amount of acid consumed and the amount of hydrogen chloride in the waste gas are lower than if more concentrated hydrochloric acid is used. The presence of dissolved platinum metals does not decrease the rate of dissolution. By careful control of addition rates, a very slight excess of chlorine can be used, so that this method leads to lower levels of waste gas contamination than the aqua regia method. However, the rates of dissolution decrease considerably in

the absence of agitation, and the process is most suitable for easily stirred powders, slurries, or concentrates and unsuitable for bulk material.

Metal dissolves more slowly in the vapor phase or in refluxing hydrochloric acid containing dissolved chlorine (Figure 25.5).

Hydrogen peroxide can be used in place of chlorine as oxidizing agent. Optimum concentrations are difficult to maintain owing to the decomposition of hydrogen peroxide into oxygen and water, therefore, reaction rates are very low compared with those for HCl–Cl<sub>2</sub>. The HCl–H<sub>2</sub>O<sub>2</sub> system has some limited use for palladium.

### 25.5.3 Dissolution in Hydrochloric Acid–Bromine

Palladium dissolves more rapidly in hydrochloric acid–bromine mixtures than in hydrochloric acid–chlorine (Figure 25.5). Bromine is more soluble than chlorine in hydrochloric acid, enabling high halogen concentrations to be used. If the temperature is kept well below the boiling point of bromine (59 °C), losses in the waste gases become very small. Bromide formed in the dissolution reaction can be oxidized to bromine by chlorine in an easily controllable reaction, recovered by distillation, and recycled. Since the conversion of bromide to bromine

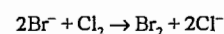

or

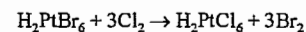

can take place in parallel with the dissolution process, bromine can be present in substoichiometric amounts.

Platinum and its alloys with rhodium or iridium are more resistant to hydrochloric acid–bromine than to hydrochloric acid–chlorine.

### 25.5.4 Other Dissolution Processes

Concentrated nitric acid is suitable for dissolving palladium (Figure 25.5).

Concentrated sulfuric acid dissolves finely divided rhodium at ca. 300 °C, but strongly

heated rhodium powder is largely insoluble in sulfuric acid.

Concentrated hydrobromic acid is the only reagent that can directly dissolve oxides of the platinum group metals such as PdO, PtO<sub>2</sub>, Rh<sub>2</sub>O<sub>3</sub>, and IrO<sub>2</sub>. Platinum can be dissolved in a mixture of hydrobromic acid and bromine above 100 °C in a pressurized reactor. Metallic rhodium is quite soluble in concentrated hydrobromic acid near its boiling point.

Powdered ruthenium or osmium can be treated with an alkaline solution of potassium peroxodisulfate (K<sub>2</sub>S<sub>2</sub>O<sub>8</sub>) to form solutions of ruthenate or osmate. In acidic media, osmium is oxidized by peroxodisulfate or chromic acid to form OsO<sub>4</sub>.

Perchloric acid has been reported to be a solvent for platinum and its alloys, ruthenium, and osmium.

### 25.5.5 Salt Fusion [33]

Aqueous dissolution processes are not successful for all types of concentrates and raw materials. Often, reactions in molten salts are more effective. For many raw materials, molten salt methods are selective and therefore also suitable for separation.

Rhodium can be converted into water-soluble rhodium(III) sulfate at ca. 600 °C by melting with potassium or sodium hydrogensulfate, which is converted to the pyrosulfate with loss of water. Platinum, iridium, and ruthenium are not attacked.

Ruthenium is converted into water-soluble K<sub>2</sub>[RuO<sub>4</sub>] when reacted with KOH–KNO<sub>3</sub>. Osmium reacts similarly. This reaction can be used to treat finely divided osmiridium, especially after preliminary treatment with molten zinc, in which the iridium remains undissolved (see also Section 25.4.4). Potassium salts are more effective than sodium salts. Alkali-metal carbonates can be used instead of alkali-metal hydroxides.

Ruthenium and osmium are very readily attacked by molten Na<sub>2</sub>O<sub>2</sub>. The reaction can be prevented from becoming too violent by addition of NaOH or Na<sub>2</sub>CO<sub>3</sub> to reduce the melt

temperature. Iridium can be oxidized to acid-soluble iridate by fusion with Na<sub>2</sub>O<sub>2</sub>.

Iridium can also be converted to acid-soluble iridate by treatment with fused BaO<sub>2</sub> or BaO<sub>2</sub>–Ba(NO<sub>3</sub>)<sub>2</sub>. This has the advantage of enabling the cation to subsequently be removed simply by precipitation as BaSO<sub>4</sub>. The process is also used to treat osmiridium, although osmium is converted to OsO<sub>4</sub> and must be recovered from the waste gas.

When mixtures of powdered platinum group metals are heated at 700 °C in a chlorine atmosphere, acid-soluble chlorides of palladium and platinum, and acid-insoluble RhCl<sub>3</sub>, are formed. Chlorination of iridium and ruthenium produces substoichiometric acid-insoluble products.

All of the platinum group metals form water-soluble complex chlorides when treated with sodium chloride in a chlorine atmosphere.

## 25.6 Separation of Platinum Group Metals [30, 96]

After the platinum group metals have been dissolved, the individual metals must be recovered. Depending on the raw material, the solution may contain all or some of the PGMs, together with gold, silver, and base metals.

Over the past 200 years, numerous separation processes have been developed and used [30, 31, 34, 39]. Many of the individual steps are still very important in modern processes. Others are of historical interest, but may be used in special cases to treat very small quantities. In addition to the large-scale separations carried out by mining companies and refineries a number of small companies exist, mainly in the United States.

In general, coarse separation is followed by a purification stage. The process used for coarse separation is determined largely by the composition of the starting solution, and the purification process depends on the particular PGM. The purification stage is necessary because, with few exceptions, an individual platinum group metal of commercially acceptable

purity cannot be isolated from complex solutions in a single step.

In practice, the composition of the raw material changes frequently and profoundly, especially in the recovery of secondary metal. Here, the crude separation process must be very flexible. In separation plants that are parts of mining operations, the raw material is usually fairly consistent over a long period of time.

The most important separation processes today make use of various combinations of precipitation, crystallization, solvent extraction, and distillation.

To achieve the necessary performance economically, a high selectivity, a good yield of noble metal, and (to minimize loss of the interest-earning potential of high-value materials) a short treatment time are required.

### 25.6.1 Chemistry of Platinum Group Metal Separation [97–108]

Of the many known reactions in PGM chemistry, certain ones have been developed to separate the metals or have been shown to be especially useful for this purpose. This is true both for crude separation and for purification; in many cases the same reaction is equally important in both stages.

**Dissolution Properties.** Differences in reactivity toward chemical reagents, especially oxidizing acids and molten salts, can often be utilized for coarse separation of platinum group metals. Good separation is possible only if platinum and palladium do not form mixed crystals with the refractory PGMs.

**Solution Equilibria.** In the crystallization process (by either evaporation or precipitation), the solubilities of chloro complexes of the platinum group metals are very important, as is the possibility of altering these solubilities. The temperature dependence of these solubilities is generally quite large and can be utilized or must be considered, in many stages of the process. In the range between room temperature and 100 °C, solubilities differ by about a factor of 10 (Figure 25.6). An even

more useful phenomenon in separation technology is the effect on solubility of the addition of a common ion, which is utilized in precipitation crystallization (Sections 25.6.3 and 25.6.4). Solubility can usually be varied over two orders of magnitude (Figure 25.7). The solubility of AgCl is affected not only by the concentration of the acid but also by that of  $H_2PtCl_6$ .

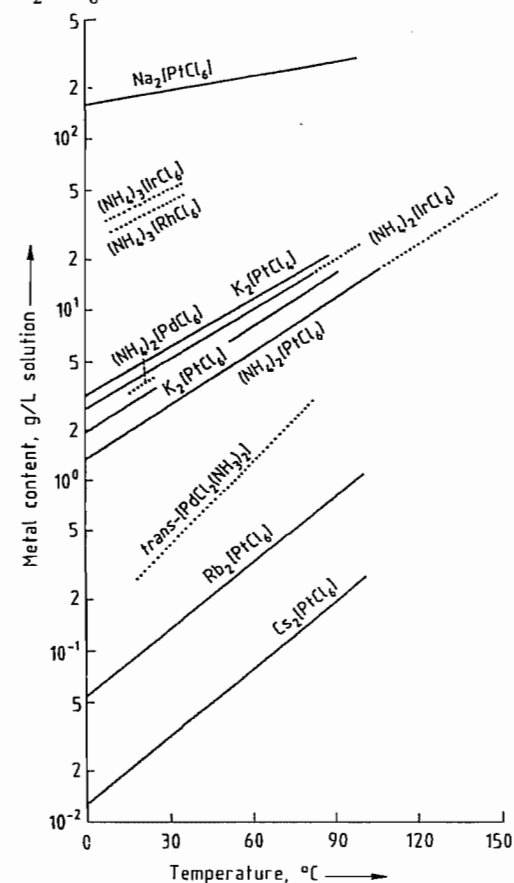

Figure 25.6: Solubility of platinum group metal chloro complexes in water as a function of temperature. .... unstable solution equilibrium; — stable solution equilibrium.

**Redox Reactions and Stability of Complexes [85, 109].** Many separations are made possible by valence changes in redox systems. This applies mainly to precipitation crystallization, but also to solvent extraction and distillation. In practice, the kinetic and thermal

stabilities of the valences in complexes are important, as is the redox stability (Table 25.5).

Table 25.5: Stability of platinum group metal chloro complexes.

Metal	Oxidation state	Complex	Redox stability	Kinetic stability	Thermal stability
Pt	IV	$[PtCl_6]^{2-}$	stable	very stable	very stable
Pt	II	$[PtCl_4]^{2-}$	unstable	unstable	
Pd	IV	$[PdCl_6]^{2-}$	unstable	stable	unstable
Pd	II	$[PdCl_4]^{2-}$	stable	very stable	
Ir	IV	$[IrCl_6]^{2-}$	stable	stable	
Ir	III	$[IrCl_6]^{3-}$	stable	stable	
Rh	III	$[RhCl_6]^{3-}$	stable	stable	unstable
Ru	IV	$[RuCl_6]^{2-}$	unstable		unstable

**Hydrolysis [89, 97, 110].** Hydrolytic effects can frequently reduce the completeness of a desired reaction, thereby adversely affecting separation. Most chloro complexes of PGMs are susceptible to hydrolysis at high temperature, thereby reducing their redox stability. The possible stepwise hydrolytic conversion of  $[RhCl_6]^{3-}$  to  $[Rh(H_2O)_6]^{3+}$ , and of  $[PtCl_6]^{2-}$  to  $[Pt(OH)_6]^{2-}$ , must be taken into account. Similar hydrolytic effects are also common with ruthenium and iridium. The reactions outlined here generally take place with widely varying rates. This is true for reaction in both directions (e.g., for hydrolysis and for the reverse reaction in the presence of acid). For example, when a suspension of  $(NH_4)_2[PtCl_6]$  is heated, the concentration of dissolved platinum (after being cooled to 20 °C) increases in 24 h from 2.2 g/L to twice this amount, and after 96 h it increases fourfold. This is due to partial hydrolysis to give soluble compounds. The reverse reaction, brought about by heating with hydrochloric acid at its azeotropic concentration, occurs at similar rates.

**Ion Exchange Chromatography.** The use of ion exchange is limited mainly to the separation of PGMs from base metals [111]. For example, selective adsorption of  $[PtCl_6]^{2-}$  on strongly basic anion-exchange resins is possible, followed by elution with sodium hydroxide solution, yielding  $[Pt(OH)_6]^{2-}$ . The separation of a PGM mixture into individual PGMs by chromatography is described in [112, 113].

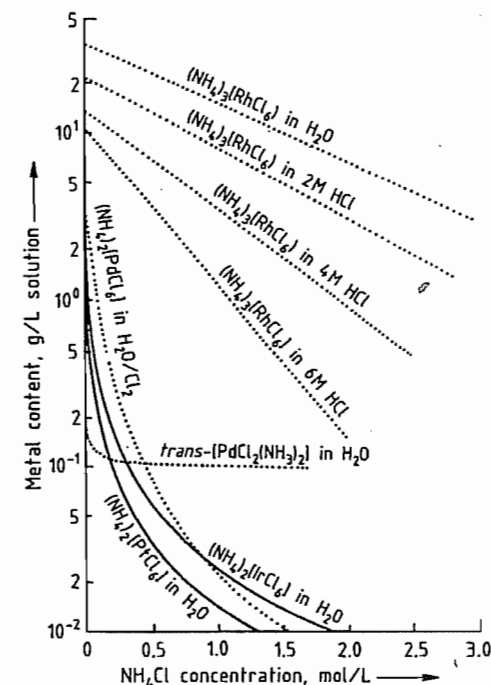

Figure 25.7: Dependence of the solubility of platinum group metal chloro complexes on the concentration of  $NH_4Cl$  and HCl at 20 °C. .... unstable solution equilibrium; — stable solution equilibrium.

**Organic Precipitation Agents [114, 115].** Palladium can be selectively precipitated by dimethylglyoxime, but the precipitate is difficult to filter. Separation systems have also been reported that depend on the formation of complexes of the PGM with substituted formazanes and substituted benzoylthiourea. Precipitable organometallic compounds can often be recovered by solvent extraction instead of precipitation.

**Distillation and Sublimation.** The only industrial use of distillation or sublimation at present is the separation of  $RuO_4$  and  $OsO_4$ , usually by steam distillation. These substances have high vapor pressures even at room temperature, so a noncondensable carrier gas cannot be used because of the high carryover of material. A possible future process is the separation of PGM by using sublimation of PGM fluorides [116].

**Reduction to Metal.** Since the PGMs are all electrochemically noble metals, selective reduction and cementation by base metals are not possible. In the past, collective cementation from aqueous solution by zinc was often an important step, both for separation and for the recovery of PGMs from recycled solutions. However, the use of zinc as a cementation agent is now ruled out for environmental reasons. Where cementation cannot be avoided, iron, aluminum, or Fe–Al alloys can be used instead. In aqueous media, hydrazine, formate, or borate can be used to reductively precipitate elemental PGMs.

**Solvent Extraction** [117–126]. Many liquid–liquid extraction systems have been described that can be used for solvent extraction of metals. Much research into the platinum group metals has been carried out, mainly aimed at their separation. The extraction processes do not usually involve a true Nernst distribution of the extractable compounds between the organic and the aqueous phases. More often, the extractable compounds (generally organometallic) are formed in the extraction system itself. The reactants are dissolved in an inert organic phase or, if they are themselves liquids, can be used as such. The system is generally diluted with an inert solvent to lower the viscosity.

The extractants and extraction mechanisms are classified in the following groups:

- Compound formation
- Anion exchange
- Cation exchange
- Solvation
- Solvent extraction without reaction

Of the many systems investigated, very few are of practical use.

The organic phase often increases significantly in viscosity as metal content increases and is usually diluted by a hydrocarbon mixture in the 150–200 °C *bp* range.

The extracted metal is stripped from the organic phase by an aqueous phase.

## 25.6.2 Old Separation Processes

[30]

Some separation methods, shown in Figure 25.8, were commonly used for separating PGMs in earlier times. Modifications of these may still be used today or included with more modern individual stages in an integrated process. In special cases, they can contribute to the solution of separation problems.

**Separation Process A** [34, 41]. The process used by INCO in the Acton refinery in England has been known for a long time. It is especially suitable for treatment of the anode slime from the electrolysis of nickel. Here, selective dissolution of Pt–Pd can be achieved since the refractory PGMs are concentrated in separate particles. Some special process steps are used, including alloying with lead, and selective dissolution of rhodium, ruthenium and iridium by salt fusion.

**Separation Process B.** A process formerly used by the platinum smelting company Siebert/Degussa is characterized by the recycling of unacceptably large amounts of platinum due to the relatively high solubility of sodium chloroplatinate. Recovery of the rarer platinum group metals by cementation led to serious pollution of the wastewater. The cemented metals were usually dissolved with  $\text{NaCl}-\text{Cl}_2$ . An advantage of the process was the efficient separation of iridium.

**Separation Process C** [34, 127, 128] is suitable only for raw materials with low palladium, rhodium, and iridium content, because of the difficulty of handling their hydroxide precipitates, which have adsorptive properties. It has been used only in small separation plants for secondary metal and yields very pure platinum.

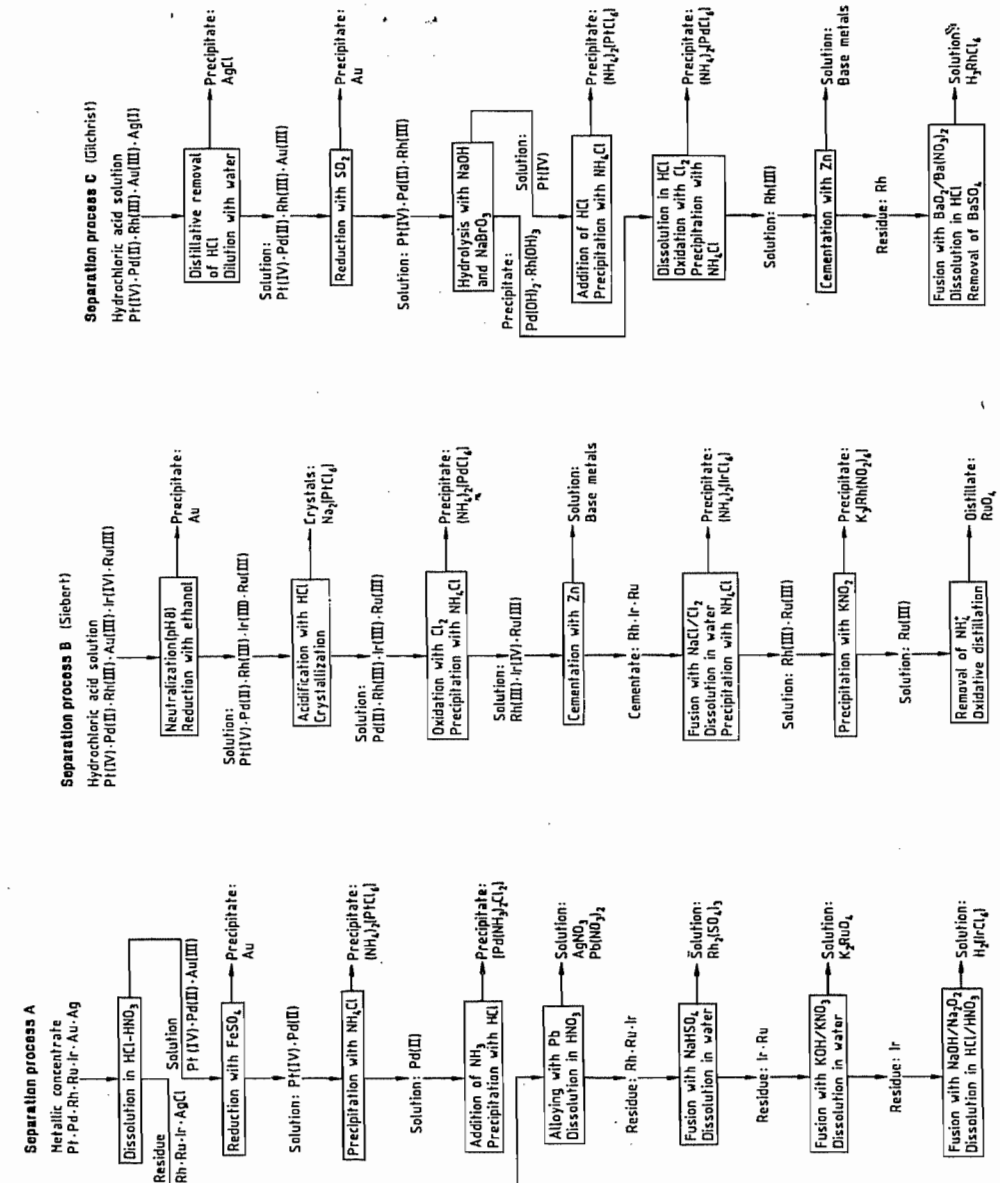

Figure 25.8: Older separation processes.

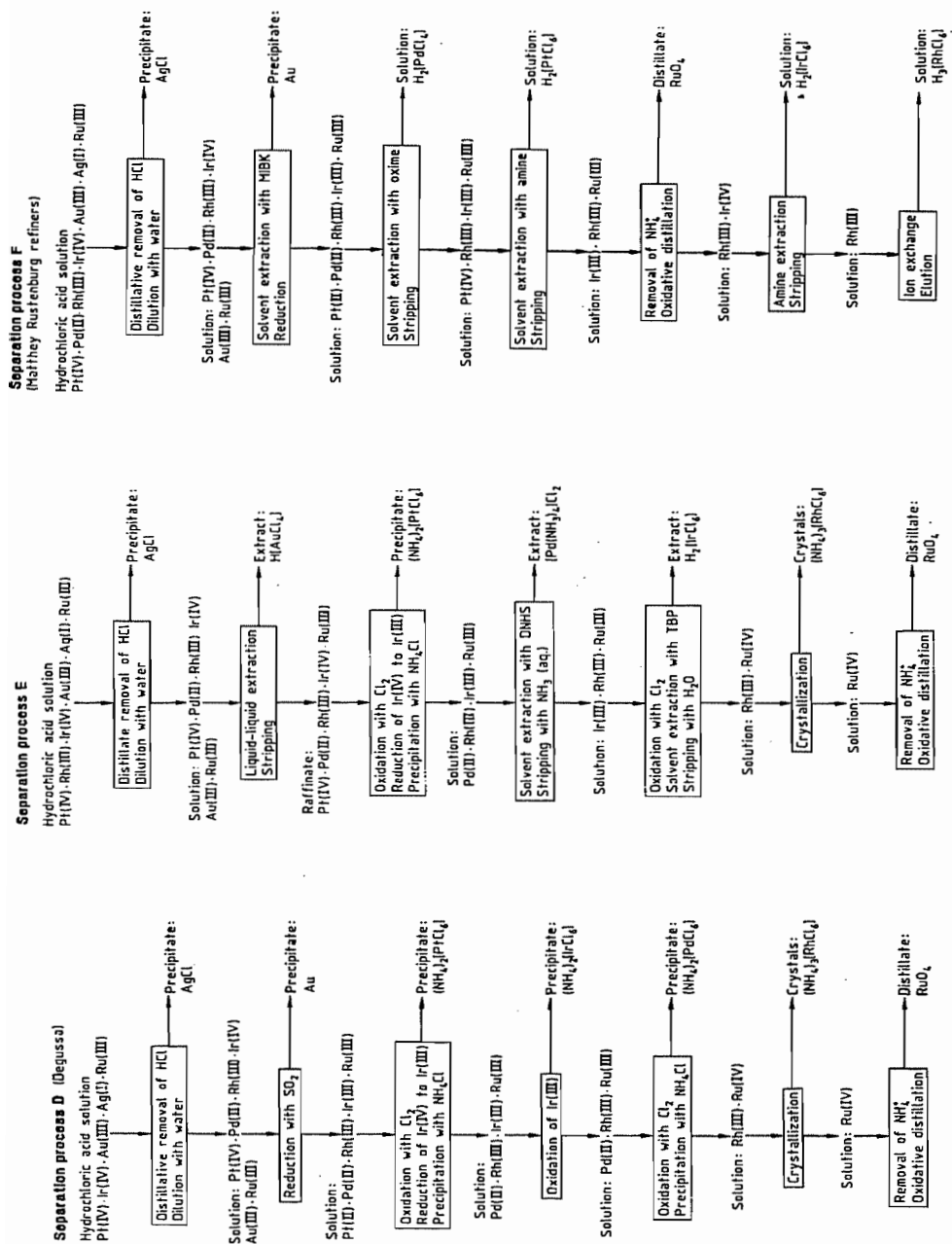

Figure 25.9: Modern separation processes.

### 25.6.3 Current Separation Processes

Modern separation processes (Figure 25.9) are designed for high separation efficiency, minimum recycle, reduced holdup times of expensive PGMs, and minimization of losses of noble metals. Ecological considerations are often crucial, even when costs must be kept low. Thus, cementation on zinc, an extremely expensive process even if the cost of necessary wastewater treatment is excluded, has to a very large extent been eliminated from PGM separation processes for environmental reasons.

**Separation Process D** [30, 85]. All process steps can be carried out on the same solution by using simple, similar process operations, which is economically beneficial. The process is very flexible, which is an advantage, particularly for the recovery of secondary metal when the ratio of PGMs changes continuously. If the ruthenium content is high,  $\text{RuO}_4$  should be removed by distillation as the first step of the separation process.

**Separation Process E.** Solvent extraction with dialkyl sulfide is used. Unlike process D, this provides a practically quantitative and sharp separation of palladium, which yields favorable conditions for the purification of palladium and platinum. Solvent extraction of iridium can be carried out almost quantitatively and is very useful when iridium content is low. Under these conditions, use of precipitation crystallization would result in excessive amounts of iridium remaining as soluble  $(\text{NH}_4)_2[\text{IrCl}_6]$  in the mother liquor.

**Separation Process F** [129]. A process used mainly in mining operations (i.e., with primary raw materials) has, as its most notable feature, solvent extraction of platinum, which is the metal present in highest concentration. Oximes are better than thioethers for solvent extraction; the higher rate of complex formation enables column technology to be used. Also, the separation process can be set up as an integrated unit. Ion exchange, which is also carried out on columns, results only in separa-

tion of base metals. Similar separation processes based on solvent extraction are in industrial use or development [122–126, 130–136].

### 25.6.4 Processes Used in Coarse Separation [30]

**Separation of Silver.** Insoluble silver chloride is formed in the dissolution process and is removed by careful filtration from the starting solution in concentrated hydrochloric acid. However, this acid at its usual concentration leads to unacceptably high levels of silver remaining in solution due to  $\text{H}[\text{AgCl}_2]$  formation. Lowering the free hydrochloric acid concentration, preferably by evaporation and dilution, considerably reduces the solubility of silver chloride. The settling rate and ease of filtration are improved by flocculating agents.

Traces of silver (usually together with Cu and Pd) can be extracted from chloride solutions of platinum group metals at pH 5.5 by dithizone in chloroform.

**Separation of Gold.** The usual process for gold separation involves reducing Au(III) to elemental gold in acid solution. Reducing agents that can be used include iron(II) salts, oxalic acid, sulfur dioxide, and ascorbic acid. Sodium nitrite, hydrogen peroxide, sodium formate, and ethyl alcohol are also used [126]. The separation process is improved if reducing agents and reaction conditions are chosen such that Pt(IV) is not reduced to Pt(II). Otherwise, Pt(II) must be reoxidized to Pt(IV). The separation of gold from PGMs is becoming increasingly important [136].

**Selective Dissolution Reactions and Melt Reactions.** Dissolution processes usually do not give very sharp separation of platinum group metals.

Problems with salt fusion lead to poor diffusion conditions. In dry chlorination of platinum group metals, the chlorides are thermodynamically stable over only a small range. Also, in reaction of the metals with sodium chloride and chlorine, temperatures must be chosen such that unreacted metal particles

are not blocked by molten salt. In practice, achieving complete reaction in a single stage is usually impossible.

**Separation of Platinum, Iridium, and Palladium by Precipitation Crystallization** [137–139]. The same basic process has been used for the separation of the largest quantities of platinum group metals since the beginning of separation technology—precipitation crystallization of ammonium hexachloro complexes  $(\text{NH}_4)_2[\text{MCl}_6]$ . This process can be optimized in many ways by influencing solubilities (e.g., by valence changes, addition of a common ion, or changing the temperature and rate of precipitation).

The first step in separation is usually to precipitate platinum as  $(\text{NH}_4)_2[\text{PtCl}_6]$ . If the dissolved platinum is present as  $\text{Pt}^{\text{II}}$ , it must first be oxidized to  $\text{Pt}^{\text{IV}}$  (e.g., by chlorine). Excess dissolved chlorine is driven off by boiling, which also causes the palladium that had been oxidized to palladium(IV) to be reduced to palladium(II). Any iridium(IV) present must be selectively reduced to iridium(III), for example, with iron(II) salts or ascorbic acid. The ammonium hexachloroplatinate(IV) is precipitated preferably by slow addition of concentrated ammonium chloride solution at room temperature with stirring. The hydrochloric acid concentration should be 1 M, and the platinum content should be 50–200 g/L. After precipitation, the excess of  $\text{NH}_4\text{Cl}$  in the solution should be at least 0.5 mol/L. The mother liquor is removed from the salt by washing with semisaturated cold ammonium chloride solution. The deep-yellow ammonium hexachloroplatinate(IV) is recovered with a purity of 99.0–99.5% in > 99% yield.

Attempts have been made to precipitate the  $(\text{NH}_4)_2[\text{PtCl}_6]$  slowly by gradual formation of  $\text{NH}_4^+$  ions in the reaction medium (e.g., by hydrolysis of urea or hexamethylenetetramine). In this way, an almost ideally homogeneous precipitation medium is produced. However, the purities and yields achieved do not justify the cost.

To precipitate iridium as  $(\text{NH}_4)_2[\text{IrCl}_6]$ , iridium(III) is converted to iridium(IV) by treat-

ment with an oxidizing agent at ca. 100 °C, while palladium remains in the divalent state at this temperature. Black  $(\text{NH}_4)_2[\text{IrCl}_6]$  is filtered off from the cold solution. It is more readily soluble than the corresponding platinum salt, and therefore sufficient excess of  $\text{NH}_4\text{Cl}$  (0.5–1.0 mol/L) and good cooling (20 °C) must be used, and the minimum amount of concentrated  $\text{NH}_4\text{Cl}$  solution must be used for washing. Chlorine is then passed into the solution at room temperature, the excess  $\text{NH}_4\text{Cl}$  in solution being > 1 mol/L, and palladium is precipitated in the pure state in the form of the sparingly soluble, brick-red ammonium hexachloropalladate(IV),  $(\text{NH}_4)_2[\text{PdCl}_6]$ . The separation from rhodium(III) is, however, not sharp.

The main problem encountered in this precipitation is the difficulty of producing sufficiently large crystals for filtration, which can be favored by adding the palladium solution to the  $\text{NH}_4\text{Cl}$  solution. High temperature favors crystal growth but must be avoided to prevent the following reaction from occurring:

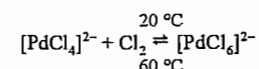

A virtually quantitative yield is obtained if the crystals are isolated quickly and washed with a cold concentration  $\text{NH}_4\text{Cl}$  solution saturated with  $\text{Cl}_2$ .

**Separation of Rhodium.** Ammonium hexachlororhodate,  $(\text{NH}_4)_3[\text{RhCl}_6]$ , can be isolated from rhodium solutions in hydrochloric acid such as those obtained after removal of the other platinum group metals. Ammonium chloride is added, followed by concentration and crystallization. Much of the remaining  $(\text{NH}_4)_2[\text{PtCl}_6]$  and  $(\text{NH}_4)_2[\text{IrCl}_6]$  is precipitated at the same time. Chlorides of the base metals mostly remain in solution. The  $(\text{NH}_4)_3[\text{RhCl}_6]$  can be selectively redissolved in water at room temperature to form an almost saturated solution. This gives a purified solution of rhodium. Both  $(\text{NH}_4)_2[\text{PtCl}_6]$  and  $(\text{NH}_4)_2[\text{IrCl}_6]$  are recovered by filtration.

The rhodium can also be isolated as chloropentamminerhodium(III) chloride,  $[\text{RhCl}$

$(\text{NH}_3)_5]\text{Cl}_2$ , or potassium hexanitrorhodate(III),  $\text{K}_3[\text{Rh}(\text{NO}_2)_6]$ , but the precipitations must be carried out in weakly alkaline solution. These methods are unsuitable for solutions that contain large quantities of base metals because, under reaction conditions, these form insoluble hydroxides that are difficult to filter.

Cementation of rhodium by other metals (see Section 25.6.3) can also be carried out. However, all of the noble metals and the copper remain with the rhodium. An advantage is that precipitation of rhodium is complete in this process.

**Distillation of Ruthenium(VIII) Oxide.** The most important industrial process for the isolation of ruthenium is distillation of the very volatile ruthenium(VIII) oxide,  $\text{RuO}_4$ , from aqueous solution. This compound is formed in solutions of potassium ruthenate(VI),  $\text{K}_2[\text{RuO}_4]$ , and hexachlororuthenate(III),  $\text{K}_3[\text{RuCl}_6]$ , by oxidation with chlorine at around neutral pH. Oxidation can also be carried out in dilute sulfuric acid solution with potassium permanganate, or with potassium chlorate in sulfuric acid solution, but these methods are less satisfactory for safety reasons. The volatile  $\text{RuO}_4$  is absorbed by dilute hydrochloric acid, and is converted into water-soluble chlororuthenate complexes.

Even in the absence of potassium permanganate, chlorate, or their reaction products, the distillation of  $\text{RuO}_4$  is hazardous. The presence of  $\text{NH}_4^+$  salts can lead to the formation of explosive chlorides of nitrogen. Therefore, removing ruthenium at the start of a separation process is often preferable. The formation of chlorine dioxide, chlorate, and perchlorate is also possible. Moreover,  $\text{RuO}_4$  can explode by spontaneous decomposition, especially at > 100 °C and on contact with organic substances. To improve safety, work should be carried out under an inert gas and by avoiding the presence of large quantities (e.g., using a continuous process).

**Distillation of Osmium(VIII) Oxide.** As a rule, osmium is present in only a few primary and secondary raw materials. osmium should,

if possible, be isolated as the first step of a separation process, so that later operations will not lead to loss of volatile  $\text{OsO}_4$ .

Solutions obtained from digestion of ores normally contain osmates. Treatment of solutions in dilute sulfuric acid with oxidizing agents such as  $\text{CrO}_3$ ,  $\text{K}_2\text{S}_2\text{O}_8$ , or  $\text{HNO}_3$  causes osmium(VIII) oxide to be formed and to distill off. From this distillate,  $\text{OsO}_4$  can be isolated directly as a water-insoluble oil ( $mp$  40 °C). Alternatively, it can be absorbed in potassium hydroxide solution, forming  $\text{K}_2\text{OsO}_4$ , or can be converted to metallic osmium by reaction with formaldehyde solution. Owing to the toxicity of  $\text{OsO}_4$ , its escape into the atmosphere must be prevented by use of the best possible absorption equipment. No danger of explosion exists.

Also,  $\text{OsO}_4$  can be formed and distilled off by heating fine osmium powder in a stream of oxygen.

**Solvent Extraction.** Liquid–liquid extraction is often characterized by distribution coefficients that vary greatly from element to element. These can usually be modified by chemical methods to give conditions favorable for the separation of PGMs. However, the separation factors resulting from the ratios of the distribution coefficients rarely enable a single separation stage to provide purities that fulfill modern requirements for metal quality. Although separations are generally better than those effected by precipitation crystallization, coarse separation by solvent extraction must be followed by purification.

In practical industrial separation processes, mainly four extractants are used [102, 123–126, 136–139]. The most long-standing process is the separation of Pt(IV) and Ir(IV) from Rh(III) with tributyl phosphate (TBP) [140, 141]. The extraction of  $\text{H}_2[\text{PtCl}_6]$  and  $\text{H}_2[\text{IrCl}_6]$  must be carried out in 4–6 M HCl (Figure 25.10). If the usual mixture of 1 part TBP with 3 parts petroleum ether is used, the capacity of the organic phase is limited in practice to ca. 10 g of Pt–Ir and it is therefore less suitable for extraction treatment of solu-

tions whose main constituent is platinum (e.g., normal refinery feed solutions).

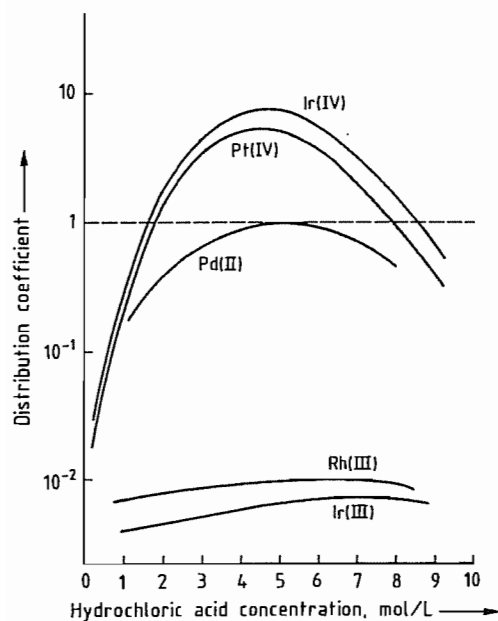

Figure 25.10: Extraction of platinum group metal chloro complexes by tributyl phosphate.

Trioctylamine is used widely for the solvent extraction of large amounts of platinum from refinery solutions [142–144]. It is also used for the solvent extraction of Ir(IV) (Figure 25.11). Stripping can be facilitated by changing the stripping solution or the valence of the metal. Diluent solvents are also employed when carrying out solvent extraction with amines.

For the solvent extraction of palladium, thioesters are currently used (e.g., di-*n*-hexyl sulfide or di-*n*-octyl sulfide) [103, 143–147]. They produce good separation from other PGMs and have a high capacity for the metal. A disadvantage is the poor kinetics of complex formation, the reaction times required being 30 mins or more. Hence, mixer settler equipment must be used rather than column equipment. Stripping with aqueous ammonia produces  $[\text{Pd}(\text{NH}_3)_4]\text{Cl}_2$ ; this can be converted easily to  $[\text{Pd}(\text{NH}_3)_2\text{Cl}_2]$ , which is then purified.

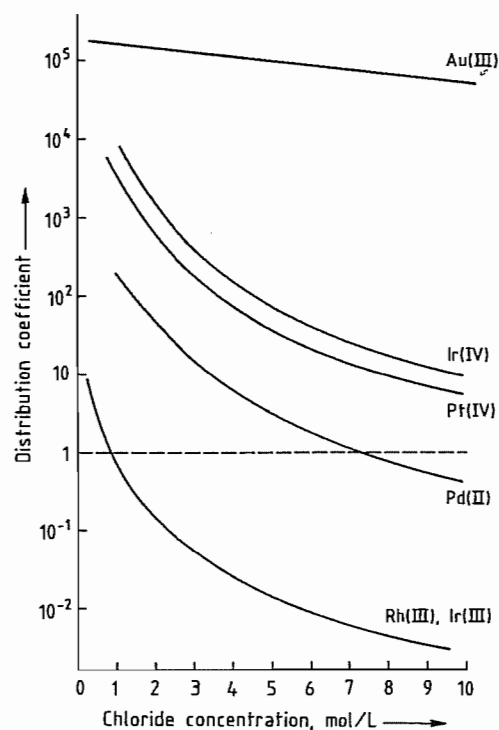

Figure 25.11: Extraction of platinum group metal and gold chloro complexes by trioctylamine.

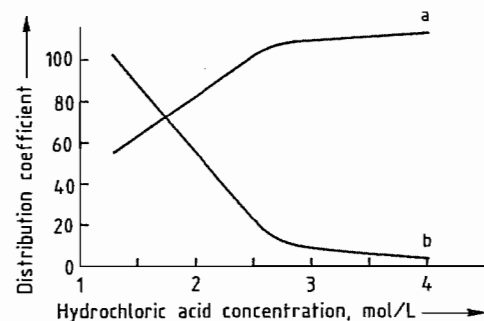

Figure 25.12: Extraction of palladium(II) and platinum(IV) chloro complexes by an aldoxime (LIX TN 1911): a) Platinum(IV); b) Palladium(II).

The method used for high-tonnage production of copper by solvent extraction with oximes is also successfully used for palladium (Figure 25.12). However, high concentrations of palladium in the organic phase cannot be achieved.

Numerous other solvent extraction systems have been investigated, some of which are un-

dergoing industrial development [107, 108, 141, 148–151].

### 25.6.5 Purification

Methods used for purification of the products from the separation process employ the same principles (i.e., valence change, temperature change, addition of common ions, and modification of complexes by chemical reaction).

**Purification of Platinum.** Recrystallization of sodium hexachloroplatinate(IV),  $\text{Na}_2[\text{PtCl}_6]$ , from hot water is effective, but large amounts of platinum must be recycled.

Very effective purification is achieved by the oxidative hydrolysis of the metallic impurities palladium, rhodium, iridium, ruthenium, and base heavy metals, which are removed as insoluble hydroxides (Figure 25.8, Separation Process C). Precipitation from hot aqueous solution is carried out by addition of sodium bromate at pH 6.5 or by passing through chlorine at slightly alkaline pH. The oxide hydrates adsorb considerable amounts of platinum. The yield of platinum therefore depends on the purity of the feed material.

The classical method of purification is by repeated precipitation of  $(\text{NH}_4)_2[\text{PtCl}_6]$ . The crude salt is converted into metallic platinum, dissolved to form  $\text{H}_2[\text{PtCl}_6]$  (see Section 25.5), and reprecipitated. By repeating this many times, very high purities are obtained, although the cost is also high. Also,  $(\text{NH}_4)_2[\text{PtCl}_6]$  can be converted directly to  $\text{H}_2\text{PtCl}_6$  by oxidation of the  $\text{NH}_4^+$  or by cation exchange. In the oxidative decomposition of  $\text{NH}_4^+$  (e.g., by heating the aqueous solution with addition of  $\text{Cl}_2$  or  $\text{HNO}_3$ ), care must be taken to use a carrier gas or distillative conditions to prevent accumulation of explosive nitrogen-halogen compounds.

Conventional crystallizations from water are possible, but the solubility of  $(\text{NH}_4)_2[\text{PtCl}_6]$  is relatively low, so that despite favorable temperature coefficients (Figure 25.6), large volumes must be used. Modified crystallization methods are more economic (e.g., utilization of the considerably higher

solubilities in water above 100 °C at higher pressure). The purification effected by crystallization is enhanced by hydrolysis. In neutral or very slightly acidic media above 90 °C, the conversion of the chloro complexes of the platinum group metals (especially metals other than platinum) into hydroxo complexes and oxide hydrates begins. These cannot form mixed crystals with  $(\text{NH}_4)_2[\text{PtCl}_6]$ . The extent of hydrolysis of hexachloroplatinate(IV) increases with increasing temperature and reaction time. Therefore, high temperature and long reaction time lead to a lower yield of crystalline product. The reaction is reversible in the presence of hydrochloric acid.

When the products of solvent extraction by substituted amines are stripped, solutions of platinum compounds in hydrochloric acid are obtained. From these, pure  $(\text{NH}_4)_2[\text{PtCl}_6]$  is precipitated by addition of  $\text{NH}_4\text{Cl}$ .

**Purification of Palladium** [152]. Impure ammonium hexachloropalladate(IV),  $(\text{NH}_4)_2[\text{PdCl}_6]$ , can be dissolved directly for purification. This is achieved by the following reaction:

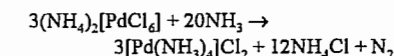

Acidification of a solution of  $[\text{Pd}(\text{NH}_3)_4]\text{Cl}_2$  precipitates the sparingly soluble, pale yellow *trans*-diamminedichloropalladium(II):

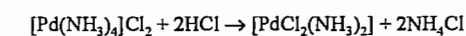

The impure salt should be dissolved quickly at room temperature with agitation to prevent appreciable quantities of the  $(\text{NH}_4)_2[\text{PtCl}_6]$  present as an impurity from dissolving. Undissolved material, mainly hydroxides and  $(\text{NH}_4)_2[\text{PdCl}_6]$ , is filtered off. Hydrochloric acid is added to the solution until a pH of 1 is reached, causing  $[\text{PdCl}_2(\text{NH}_3)_2]$  to precipitate as easily filterable crystals. Possible causes of poor purification are too high a concentration of  $(\text{NH}_4)_2[\text{PdCl}_6]$  in the impure material, too prolonged a reaction with ammonia, too high a concentration of ammonia, or problems with filtration of the hydroxidic precipitate before precipitating  $[\text{PdCl}_2(\text{NH}_3)_2]$ . High temperature is also detrimental. If the acid concentration is

too high, the yield is reduced due to further reaction to form soluble  $(\text{NH}_4)_2[\text{PdCl}_4]$ .

Other possible methods for dissolving  $(\text{NH}_4)_2[\text{PdCl}_6]$  are

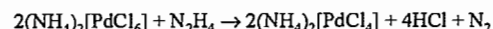

or

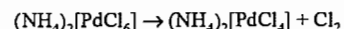

Pure  $(\text{NH}_4)_2[\text{PdCl}_6]$  can be obtained in almost quantitative yield by passing chlorine through the solution and adding  $\text{NH}_4\text{Cl}$ .

The purification of  $(\text{NH}_4)_2[\text{PdCl}_6]$  by reprecipitation is useful in the presence of silver and most base metals. In the presence of rhodium, platinum, iridium, and copper, however, better purification is achieved by precipitating  $[\text{PdCl}_2(\text{NH}_3)_2]$ , although higher losses of palladium to the mother liquor must be tolerated.

Dichlorodiamminepalladium(II),  $[\text{PdCl}_2(\text{NH}_3)_2]$ , can be produced by direct precipitation from an impure solution of palladium resulting from crude separation or inadequate purification. It is dissolved in aqueous ammonia solution to form  $[\text{Pd}(\text{NH}_3)_4]\text{Cl}_2$  and reprecipitated by hydrochloric acid.

An ammoniacal stripping solution is used after solvent extraction of palladium by dialkyl sulfide. Palladium can be precipitated from this by acidifying to pH 1, thus producing  $[\text{Pd}(\text{NH}_3)_2\text{Cl}_2]$  directly in a highly pure form.

**Purification of Iridium.** The purification of crude ammonium hexachloroiridate(IV),  $(\text{NH}_4)_2[\text{IrCl}_6]$ , is carried out by precipitation of the unwanted elements as sulfides; these consist mainly of other platinum group metals and heavy base metals. This converts hexachloroiridate(IV) to hexachloroiridate(III), which must be reoxidized to precipitate  $(\text{NH}_4)_2[\text{IrCl}_6]$ . The sulfides are precipitated from slightly acidic solution by hydrogen sulfide. To ensure optimum precipitation conditions for all elements present, the sulfide precipitation must usually be carried out repeatedly. Iridium can be purified by liquid-liquid extraction [153]. It is extracted relatively easily in the tetravalent state, but not in the trivalent state (cf. Figure 25.10). Reduc-

tion by  $\text{Fe}^{2+}$ ,  $\text{As}^{3+}$ , or ascorbic acid at room temperature causes selective reduction of Ir(IV) or Ir(III); Pt(IV) is unaffected.

**Purification of Rhodium** [154]. Ammonium hexachlororhodate(III),  $(\text{NH}_4)_3[\text{RhCl}_6]$ , can be crystallized from water or hydrochloric acid. However, the yields are poor, as is the degree of separation from platinum and iridium. Precipitation of  $[\text{Rh}(\text{NH}_3)_5\text{Cl}]\text{Cl}_2$  or  $(\text{NH}_4)_3[\text{Rh}(\text{NO}_2)_6]$  is more effective, although yields are not good, and treatment of the mother liquor is problematical.

Good results are obtained when  $\text{H}_2[\text{PtCl}_6]$  and  $\text{H}_2[\text{IrCl}_6]$  are removed by liquid-liquid extraction, and base metal cations by strongly acidic ion-exchange resins. At one time, treatment of crude rhodium with chlorine at 700 °C was an important process. The reaction product consisted mainly of insoluble  $\text{RhCl}_3$  from which the chlorides of platinum, palladium, and base metals were dissolved by treatment with hydrochloric acid. Satisfactory purification could usually be obtained only by repeating the process.

Crude potassium hexanitrorhodate(III),  $\text{K}_3[\text{Rh}(\text{NO}_2)_6]$ , can be converted to hexachlororhodate(III) by heating with hydrochloric acid. This can be followed by reprecipitating  $\text{K}_3[\text{Rh}(\text{NO}_2)_6]$  or precipitating  $[\text{RhCl}(\text{NH}_3)_5]\text{Cl}_2$ .

### 25.6.6 Conversion of Salts into Metals [30, 34, 39, 101, 111]

The end products of PGM separation are metal compounds, but all platinum group metals are marketed almost exclusively in the form of metallic sponge or powder.

Conversion to the metals is carried out mainly by thermal decomposition of the ammonium chloro complexes (calcination). These compounds have decomposition temperatures (Figure 25.13), of 200–500 °C. The size and geometry of the charge affect the reaction course. The low thermal conductivity of the charge means that the reaction proceeds slowly, but smooth production of the desired decomposition products is ensured. Also, the

negative heat of reaction of the decomposition tends to slow down the process. In practice, favorable conditions are achieved by external heating at 900–1000 °C.

In earlier days, the thermal decomposition of PGM compounds was carried out in gas-heated muffle furnaces that were not very leaktight. The best of these were provided with a collection chamber for  $\text{NH}_4\text{Cl}$  (sublimation temperature 340 °C) and included a waste gas system [41]. Today, tubular fused silica reactors, enclosed in an electrically heated furnace, are used. A stream of inert gas can be passed through at a controlled rate, and absorption equipment is present for  $\text{NH}_4\text{Cl}$  and  $\text{HCl}$ . Automated plants are in operation [155, 156].

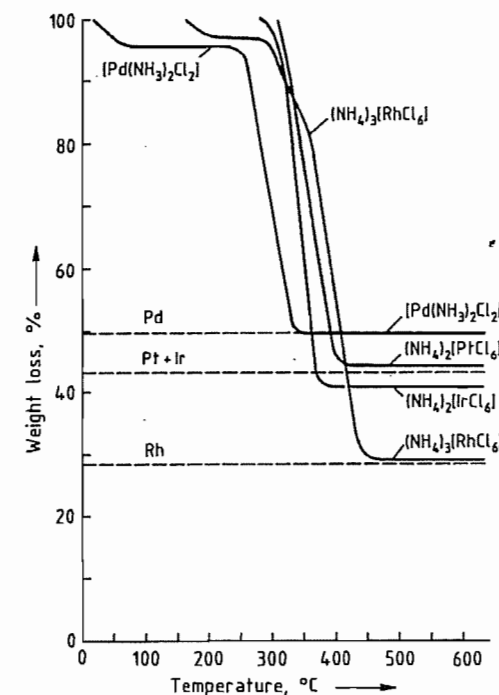
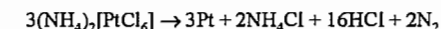

Figure 25.13: Thermal decomposition of platinum group metal complexes.

Thermal treatment of PGM compounds can also be carried out in the presence of hydrogen. For safety reasons, a mixture of hydrogen and nitrogen below the ignition temperature is preferable.

Chemical reduction of PGM compounds in aqueous medium (e.g., by hydrazine) has not proven to be economical in large refineries.

**Platinum.** The compound  $(\text{NH}_4)_2\text{PtCl}_6$  can be converted to platinum sponge by thermal decomposition at 800 °C, according to



Excessive carryover of platinum can be avoided by introducing ammonium hexachloroplatinate(IV) into the reaction zone at ca. 300 °C and heating it rapidly. Waste gas is washed with water to extract ammonium chloride, both for environmental reasons and to prevent the loss of traces of platinum.

If the reaction is carried out in a hydrogen atmosphere, elemental platinum is formed below the sublimation temperature of  $\text{NH}_4\text{Cl}$  (ca. 350 °C). Platinum carryover is then appreciably less, and more ammonium chloride is formed:

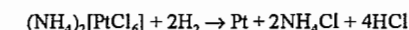

If  $\text{NH}_4\text{Cl}$  is not sublimed but is removed by dissolving in water, finely divided platinum powder can be produced by this process. Calcination of the hexachloroplatinate(IV) of an alkali metal is not recommended, because the alkali metal chloride produced is difficult to remove by aqueous dissolution from the platinum sponge.

Hexachloroplatinates can usually be reduced in aqueous solution or suspension according to

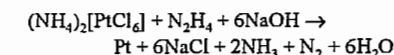

The reaction proceeds best above 80 °C, with excess  $\text{NaOH}$  maintained at 2 M and the reaction controlled by adjusting the rate of addition of  $\text{N}_2\text{H}_4$ . The reaction must be flushed with nitrogen, because hydrogen can be formed in a side reaction. The platinum black formed is washed to remove salts, and either dried to produce powder or heated strongly to produce sponge. Overall, wet chemical reduction is more expensive than calcination but should be used if alkali metal hexachlorometallates are present, because their decomposition products cannot be sublimed.



**Palladium.** The thermal decomposition of dichlorodiamminepalladium(II),  $[\text{Pd}(\text{NH}_3)_2\text{Cl}_2]$ , begins at ca. 290 °C in an inert atmosphere. Process conditions are the same as for  $(\text{NH}_4)_2[\text{PtCl}_6]$ . The reaction is

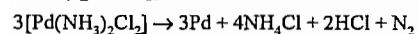

For the calcination of ammonium hexachloropalladate(IV), which loses chlorine at ca. 280 °C, the temperature should be increased extremely slowly over the range 100–300 °C. If calcination is carried out in air, the palladium sponge formed contains large amounts of PdO, which must be reduced by strong heating in a hydrogen atmosphere.

The wet chemical reduction

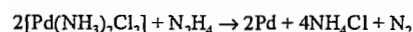

and the reduction of  $(\text{NH}_4)_2[\text{PdCl}_6]$  proceed quantitatively in strongly ammoniacal solution above 50 °C. Sodium formate in alkaline solution can also be used as reducing agent. A nitrogen atmosphere must be used in both cases to prevent formation of explosive gas mixtures. Chemical reduction often produces pyrophoric palladium black, which must be dried in an inert gas atmosphere.

**Iridium.** The best method of producing iridium is to reduce ammonium hexachloroiridate(IV),  $(\text{NH}_4)_2[\text{IrCl}_6]$ , in a hydrogen atmosphere ca. 800 °C, yielding the metal powder. Calcination in air gives an oxide-containing material. Wet chemical reduction with hydrazine is possible only in strongly alkaline sodium hydroxide solution and does not always go to completion.

**Rhodium.** Ammonium hexachlororhodate(III) is subjected to the same process of thermal reduction as used for  $(\text{NH}_4)_2[\text{IrCl}_6]$ .

Wet chemical reduction with hydrazine according to

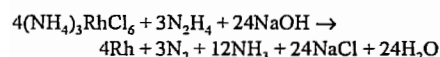

must be carried out with a large excess of hydrazine and NaOH at ca. 100 °C to ensure complete reaction.

**Ruthenium.** Ammonium hexachlororuthenate(III–IV) is reduced, preferably in a hydro-

gen atmosphere, at ca. 800 °C. Aqueous solutions of ruthenates(IV) (e.g., produced by adding  $\text{RuO}_4$  to an alkali-metal hydroxide solution) are treated with ethanol to precipitate hydrated  $\text{RuO}_2$ , which is reduced in a hydrogen atmosphere at 800 °C.

**Osmium.** Osmium tetroxide that has been absorbed in potassium hydroxide solution is precipitated as potassium osmate(IV) by adding ethanol. This is reduced by strong heating in a hydrogen atmosphere or reacted with  $\text{NaBH}_4$  in aqueous solution [157]. The product must be washed with water in both cases.

### 25.6.7 Partial Purification

**Platinum–Rhodium Mixtures.** For industrial use, platinum and rhodium are often alloyed together, and separating these elements during the recovery process may be unnecessary. The solutions obtained by dissolving metallic platinum rhodium scrap can be used. The neutral solutions are treated with a sodium-loaded ion exchanger to replace all unwanted cations with sodium. Sometimes,  $\text{Na}^+$  is replaced by  $\text{H}^+$ , giving a solution of  $\text{H}_2[\text{PtCl}_6]$  and  $\text{H}_3[\text{RhCl}_6]$  suitable for further treatment (e.g., reduction by hydrazine to give Pt–Rh powder).

Similar processes can be used for treating some single metal catalysts (e.g., material from the calcination of carbon palladium).

**Surface Cleaning.** Some returned metallic materials with only surface contamination require merely surface cleaning, thereby avoiding a wet separation process. They can be treated with acids, such as hydrofluoric acid, or with fused salt (e.g.,  $\text{NaHSO}_4$ ), although some of the outer layer of platinum dissolves.

### 25.6.8 Treatment of Internally Recycled Material

A buildup of base metals occurs in recycled material such as mother liquor from precipitation and crystallization. These base metals originate from the raw materials and from salts formed in the reactions, and also include

small quantities of platinum group metals from the separation process. The quantity or recycled noble metals should normally not exceed 1% of the metal in the starting material. The extent of recycle must be limited, because losses are relatively high when noble metals are recovered from this type of material.

Solutions containing platinum metals with only small amounts of other materials should be concentrated by evaporation in the presence of hydrochloric acid. They can be combined with fresh raw material for separation.

If the solutions contain only ammonium chloride and platinum group metals, they can often be reused directly as a precipitating agent after concentration in acid conditions.

If the solutions contain large amounts of salts of alkali metals, alkaline earths, or other metals along with platinum and palladium residues, it is advantageous to separate the ions  $[\text{PtCl}_6]^{2-}$  and  $[\text{PdCl}_4]^{2-}$  from the other materials by using strongly basic ion exchangers. Good separation is achieved if only the two chloro complexes are present. For rhodium and iridium this condition is often not achieved, because of hydrolysis to give hydroxo complexes, so this method cannot be used unless special precautions are taken.

In earlier times, noble metals were recovered from such solutions by cementation with zinc in a hydrochloric acid solution. Aluminum is now the preferred reducing agent because of the high cost of zinc, which must be present in large excess, and the resultant environmental problems. Noble metals can also be recovered with sodium borohydride. Alternatively, they can be reduced by hydrazine in alkaline solution. If no precautions are taken, hydroxides of base metals are also precipitated, but these can easily be redissolved. Copper is also precipitated in this reduction process. After redissolving the metals, the latter can be reprecipitated as copper(II) oxalate or another copper(I) or copper(II) salt that is sparingly soluble in slightly acidic solution.

All materials from which noble metals have been recovered must be monitored carefully for possible noble-metal content before disposal, so that no irrevocable losses occur.

### 25.6.9 Construction Materials

Many of the operations described above pose special problems in the choice of materials for equipment and vessels.

Plastics resistant to mineral acids can often be used. Vessels and reactors lined with hard rubber are resistant to acids and saturated chlorine solutions at 90 °C. Unsuitable metals for commonly occurring solutions of platinum and other platinum group metals include stainless steel, titanium, zirconium, the Hastelloys, and silver, because these materials cause cementation of platinum group metals. Tantalum is an exception. It is resistant to dissolved halogens and does not cement platinum group metals from solution. It is a suitable material for steam-heated heat exchangers. Equipment constructed of borosilicate glass and glass-lined steel reactors are chemically resistant to all of these materials. For solutions containing large amounts of ruthenium or osmium, other construction materials are recommended, including graphite for some items.

For treating raw materials with acidic molten salts or salts that have a chlorinating action, and for calcination, the use of fused silica equipment is best. Treatment with molten oxidizing alkaline salts is carried out in silver or nickel crucibles.

### 25.7 Compounds [5, 6, 29, 31, 34, 39, 85, 98–100, 158]

Because of the many possible oxidation states of platinum group metals and their tendency to form complexes, the range of compounds is extremely wide. Only a few of these are of industrial importance.

#### 25.7.1 Platinum Compounds

**Hexachloroplatinic(IV) acid,**  $\text{H}_2[\text{PtCl}_6] \cdot 6\text{H}_2\text{O}$ , theoretical platinum content 37.68%, platinum content of commercial product ca. 40% [commercial names: chloroplatinic acid, hydrogen hexachloroplatinate(IV)], forms reddish brown crystals (*mp* ca. 150 °C), which deliquesce in moist air and are readily soluble

in water or alcohol. The usual commercial product is an aqueous solution with a platinum content of 25%.

**Production.** Platinum sponge is treated with moderately concentrated hydrochloric acid saturated with chlorine in a stirred vessel at ca. 80 °C. The solution obtained is evaporated until it reaches 150 °C. When cooled, it changes into solid  $H_2PtCl_6 \cdot 4.5H_2O$ , which contains ca. 40% platinum, no mother liquor is produced. If the platinum is dissolved in aqua regia instead of hydrochloric acid chlorine, the nitric acid and NOCl formed must be removed completely, preferably by repeated evaporation to a syrupy consistency and redissolution in hydrochloric acid.

**Uses.** Hexachloroplatinic(IV) acid is the most industrially important platinum compound. It is used in the production of most other platinum compounds and preparations. It is used primarily to make catalysts by impregnating support materials.

**Hexachloroplatinates(IV).** Ammonium hexachloroplatinate(IV),  $(NH_4)_2[PtCl_6]$ , and, to a limited extent, the orange-red salt sodium hexachloroplatinate(IV),  $Na_2[PtCl_6]$ , are important in platinum separation processes (see Section 25.6).

**Platinum Chlorides.** Platinum(IV) chloride,  $PtCl_4$ , is produced by careful dehydration of  $H_2PtCl_6 \cdot 6H_2O$  at ca. 300 °C in a stream of chlorine. It is a red-brown, crystalline, hygroscopic powder with a relatively narrow range of thermal stability.

Above 380 °C,  $PtCl_4$  liberates chlorine and forms platinum(II) chloride,  $PtCl_2$ , which is stable between 435 and 580 °C. Platinum(III) chloride,  $PtCl_3$ , is probably formed as an intermediate in this reaction. Above 580 °C, further decomposition occurs to yield metallic platinum. Platinum(IV) chloride is the only chloride of platinum that is soluble in water.

Platinum(II) chloride can also be obtained from a solution of  $H_2[PtCl_4]$  by careful evaporation under vacuum. Chlorides of platinum can be produced by reacting chlorine with finely divided platinum. The chloride obtained

will be the one that is stable at the reaction temperature.

**Platinum Oxides.** The most industrially important oxide of platinum is platinum(IV) oxide hydrate,  $PtO_2 \cdot H_2O$ , a hydrogenation catalyst. To prepare this substance, a solution of 9 parts sodium nitrate and 1 part platinum as  $H_2[PtCl_6]$  is evaporated to dryness. The product mixture is finely powdered and added to molten  $NaNO_3$  (10 parts) at 520 °C with agitation. The product is dissolved in water, washed, and carefully dried to give a brown powder, insoluble in aqua regia, with poorly defined stoichiometry.

Platinum(II) oxide,  $PtO$ , and platinum(II) oxide hydrate,  $PtO \cdot H_2O$ , are also known, but have little or no industrial importance.

**Other Platinum Compounds.** The following compounds are used in aqueous electrochemistry: potassium tetranitroplatinate(II),  $K_2[Pt(NO_2)_4]$ ; dinitro-diammineplatinum(II),  $[Pt(NH_3)_2(NO_2)_2]$ ; and sodium hexahydroxyplatinate(IV),  $Na_2[Pt(OH)_6]$ .

Potassium tetracyanoplatinate(II),  $K_2[Pt(CN)_4]$ , can be used in electroplating by molten salt electrolysis. Barium tetracyanoplatinate(II),  $Ba[Pt(CN)_4]$ , is used in the manufacture of fluorescent screens. Many other cyano complexes are known. Simple cyanides such as  $Pt(CN)_2$  and  $Pd(CN)_2$  also exist.

Potassium tetrachloroplatinate(II),  $K_2[PtCl_4]$ , is a starting material for the synthesis of most Pt(II) compounds. Platinum(II) acetylacetonate is used in the pyrolytic production of platinum surface coatings (see Section 25.9.9.2) and is superior to other platinum compounds in this application.

Dichlorodiammineplatinum(II),  $[PtCl_2(NH_3)_2]$ , is of historical interest and was known in two forms: "Peyrone's chloride" and "Reiset's second chloride". In 1893, WERNER recognized that these were *cis* and *trans* isomers. The compound *cis*- $[PtCl_2(NH_3)_2]$  (*cis*-platin) is expected to grow in importance because of its cytostatic properties.

## 25.7.2 Palladium Compounds [159]

**Tetrachloropalladic(II) acid**,  $H_2[PdCl_4]$ , is stable only in solution. Commercial solutions in hydrochloric acid contain 20% palladium and are dark brown.

**Production.** The method of producing  $H_2[PdCl_4]$  solution is similar to that for  $H_2[PtCl_4]$  solution. The metal is dissolved in  $HCl-Cl_2$  or  $HCl-HNO_3$ , the rate of dissolution being higher than with platinum (Figure 25.5). If dissolution occurs below ca. 50 °C, hexachloropalladic(IV) acid is formed first.

**Uses.** The solution of tetrachloropalladic(II) acid is the most industrially important palladium preparation. It is the starting material for almost all other palladium compounds, particularly catalysts.

**Palladium(II) chloride**,  $PdCl_2$ , theoretical palladium content 60.0%, palladium content of commercial product 59.9%, is a brown to brownish violet powder, insoluble in water, but readily soluble in hydrochloric acid and solutions of alkali-metal chlorides. It sublimes at 590 °C. Decomposition begins at 600 °C and is complete at 740 °C.

**Production.** The best method of production of  $PdCl_2$  is careful evaporation of a solution of  $H_2[PdCl_4]$  in hydrochloric acid, preferably in a rotary evaporator.

**Uses.** Anhydrous  $PdCl_2$  is the starting material for a number of palladium compounds.

**Palladium Oxides.** Poorly defined oxide hydrates are obtained by adding alkali to aqueous solutions of Pd(II) compounds. The Pd(IV) oxide hydrates obtained from Pd(IV) solutions release oxygen. A catalytically active palladium preparation analogous to  $PtO_2 \cdot xH_2O$  can be obtained by evaporating a solution of  $H_2[PdCl_4]$  and  $NaNO_3$ , and fusing the product.

Stoichiometric palladium(II) oxide,  $PdO$ , which is crystallographically well defined, is obtained by reaction of palladium black with oxygen or air at 750 °C. Decomposition occurs at 850 °C.

**Palladium Ammine Complexes.** The addition of ammonia to solutions of palladium

chloride first causes the formation of a pink precipitate of the binuclear complex  $[Pd(NH_3)_4PdCl_4]$ , known as Vauquelin's salt, which is converted to soluble tetramminepalladium(II) chloride,  $[Pd(NH_3)_4]Cl_2$ , by further addition of  $NH_3$ . Acidification of this solution yields the sparingly soluble light-yellow *trans*-diamminedichloropalladium(II),  $[PdCl_2(NH_3)_2]$ . These compounds and reactions are important in the industrial separation of palladium (see Section 25.6).

**Other Palladium Compounds.** Ammonium hexachloropalladate(IV),  $(NH_4)_2[PdCl_6]$ , is important in separation technology. It is an oxidation product of tetrachloropalladate(II) (see Section 25.6). Palladium(II) sulfate, palladium(II) nitrate, and palladium(II) acetate are of some importance in preparative chemistry. The ready formation of palladium hydride is exploited industrially for example for the purification of hydrogen.

## 25.7.3 Rhodium Compounds [160]

**Hexachlororhodic(III) Acid**,  $H_3RhCl_6$ . Wet separation processes and molten salt dissolution usually produce  $(NH_4)_3[RhCl_6]$  or  $Na_3[RhCl_6] \cdot 12H_2O$  in crystalline form. Both compounds form deep-red crystals, which are very soluble in water. Free hexachlororhodic(III) acid,  $H_3[RhCl_6]$ , can be obtained by cation exchange or by oxidative decomposition of the cation in the case of the  $NH_4^+$  salt (see Section 25.6.2). The composition of the chloro complexes of rhodium depends strongly on the concentration of hydrochloric acid, the temperature, the duration of reaction, and the previous treatment of the solution. By starting with a strongly acidic medium, the following transformations are possible:

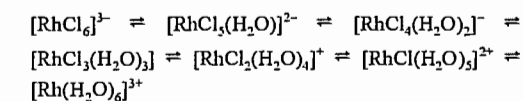

The color varies from raspberry red to brown.

**Rhodium Chlorides.** Anhydrous, brownish red rhodium(III) chloride,  $RhCl_3$ , which is insoluble in water and mineral acids, is obtained

by heating rhodium powder to 700 °C in a chlorine atmosphere.

So-called soluble rhodium chloride, with the approximate composition  $\text{RhCl}_3 \cdot 2.5\text{H}_2\text{O}$ , is obtained by evaporating a solution of  $\text{H}_2[\text{RhCl}_6]$  in hydrochloric acid, preferably in a rotary evaporator. This compound is the most important commercial rhodium product, and is used as the starting material for other rhodium compounds and catalysts.

**Rhodium Sulfate.** Rhodium(III) sulfate,  $\text{Rh}_2(\text{SO}_4)_3$ , can crystallize with varying amounts of water; it can be obtained by dissolving  $\text{Rh}(\text{OH})_3 \cdot x\text{H}_2\text{O}$  in sulfuric acid or by the action of hot sulfuric acid on freshly precipitated rhodium black. It is used in rhodium plating.

**Chloro-tris-(triphenylphosphine)rhodium(I),**  $\text{RhCl}[\text{P}(\text{C}_6\text{H}_5)_3]_3$ , is formed by the reaction of triphenylphosphine with soluble rhodium(III) chloride in ethanol solution under reflux. It separates as deep-red crystals.

This complex, and rhodium compounds with similar structures, are important homogeneous catalysts.

### 25.7.4 Iridium Compounds

**Hexachloroiridic(IV) acid,**  $\text{H}_2[\text{IrCl}_6]$ , is produced in aqueous solution by the methods used to obtain  $\text{H}_3[\text{RhCl}_6]$  (i.e., from the ammonium or sodium salts). It is by far the most important iridium compound. The oxidation state is relatively easily changed (in either direction), the very intense dark brown  $[\text{Ir}^{\text{IV}}\text{Cl}_6]_2$  changing to the lighter colored  $[\text{Ir}^{\text{III}}\text{Cl}_6]_3$  or vice versa. The ammonium salts of both anions are important in separation technology (see Section 25.6).

**Iridium(III) Chloride,**  $\text{IrCl}_3$ . A product stoichiometrically deficient in chlorine is obtained by heating iridium powder in a stream of chlorine at 650 °C. The chlorination reaction is assisted by the presence of carbon monoxide.

### 25.7.5 Ruthenium Compounds

**Ruthenium(VIII) oxide,**  $\text{RuO}_4$  is formed by the oxidation of aqueous solutions of ruthenates. It has a melting point of 25.5 °C and is therefore a liquid at room temperature. It is both toxic and explosive (see Section 25.9.1).

**Soluble Ruthenium(IV) Chloride.** So-called soluble ruthenium chloride consists mainly of  $\text{Ru}(\text{OH})\text{Cl}_3$  with some  $\text{RuCl}_3 \cdot \text{H}_2\text{O}$ , and is prepared by reacting  $\text{RuO}_4$  with hydrochloric acid and evaporating the solution. The compound  $(\text{NH}_4)_2[\text{RuCl}_6]$  can be precipitated by adding  $\text{NH}_4\text{Cl}$ .

**Potassium ruthenate(VI),**  $\text{K}_2[\text{RuO}_4]$ , is formed by fusing ruthenium with  $\text{KOH-KNO}_3$  or by dissolving  $\text{RuO}_4$  in potassium hydroxide solution.

### 25.7.6 Osmium Compounds

**Osmium(VIII) oxide,**  $\text{OsO}_4$ , is the most important osmium compound. It is formed even at room temperature by the oxidation of osmium powder by air. It is prepared by strongly heating osmium in a stream of oxygen at 500–800 °C. The melting point is 40.6 °C, and the boiling point 131.2 °C. Sublimation takes place even at room temperature.

**Potassium osmate(VI),**  $\text{K}_2[\text{OsO}_2(\text{OH})_4]$ , is formed by the reaction of  $\text{OsO}_4$  with potassium hydroxide solution and alcohol.

## 25.8 Quality Specifications and Analysis [5, 34, 161–177]

In industry, the purity and fineness of platinum and platinum metals are even today often described by the classifications “technically pure” (99%), “chemically pure” (99.9%), “physically pure” (99.99%), and “spectroscopically pure” (99.999%). These are taken from the recommendations of the Physikalisch-Technischen Reichsanstalt [28].

Present practice is to use the following qualities:

99% (now hardly used)  
99.9%

99.95%  
99.98%  
99.99%  
99.999%  
99.9999% (only in exceptional cases)

Other specifications are used for particular applications (e.g., physical properties if used in sensors or microelectronics [178, 179]).

Most commercially available platinum and palladium from primary and secondary production have purities of 99.95–99.98%. Higher purities usually sell at higher prices. Platinum and palladium are generally supplied as ingots or plates (stamped with the purity). Other platinum metals are supplied mainly as powder.

Platinum and palladium ingots of 500–1000 g are preferred for investment purposes in Japan [1].

**Determination of Purity.** The purity of commercial platinum group metals is determined by physical methods. The most important of these are emission spectroscopy, with glow discharge or spark excitation of the solid; plasma emission spectroscopy with inductively coupled plasma (ICP) or direct current plasma; and atomic absorption spectroscopy (AAS) for solutions. High-performance liquid chromatography is of minor importance for the analysis of PGMs. Mass spectrometry is used in special cases, especially for ultrapure material, recently with glow discharge excitation, ICP excitation (ICP-MS), or neutron activation.

The noble-metal content can be determined more precisely by measuring the total content of impurities than by direct determination. Physical methods for the determination of trace impurities have replaced wet chemical and colorimetric analytical methods for reasons of economy and speed.

**Trace Analysis of Platinum Group Metals.** The determination of traces of noble metals is of great importance in mineral prospecting. Since metal contents of only a few parts per million are of interest, sensitivity requirements are higher than in purity analysis. Methods such as graphite tube AAS, neutron activation analysis, total reflection X-ray fluo-

rescence analysis, and ICP mass spectrometry are used after appropriate enrichment procedures (e.g., with a nickel sulfide melt).

The analysis for traces of noble metals in waste materials from the noble-metal processing industry, especially refineries, has always been very important in monitoring the economic effectiveness of the process.

Trace analysis for platinum has become even more important in recent years. Whereas both the occurrence and the use of platinum group metals have hitherto been localized, automobile exhaust-gas catalysis now constitutes a widespread use. Although no toxic effects on the environment have thus far been reported, methods of analysis must be continually improved as permitted levels in the soil and the atmosphere become increasingly strict. The collection of the PGMs in a nickel sulfide phase, followed by spark AAS is suitable for analysis in the ppb range.

**Qualitative Analysis.** Qualitative analysis for platinum metals is used in checking the progress of industrial processes, and is a useful decision-making tool during wet chemical separation for analytical purposes.

The older wet chemical qualitative reactions have not entirely lost their usefulness.

Platinum in solution in dilute hydrochloric acid can be detected by adding tin(II) chloride. A yellow to red coloration is produced, depending on platinum concentration. The detection limit is ca. 1 mg/L (Pd, Rh, and Au can interfere).

Palladium in weakly acid solution reacts with dimethylglyoxime to give a characteristic yellow, voluminous precipitate.

Rhodium can be detected by the orange-red precipitate formed with thionalide [2-mercapto-*N*-(2-naphthyl)acetamide].

Iridium can be detected by fuming the solution with sulfuric acid and adding ammonium nitrate, which gives an intense blue color.

Ruthenium reacts with thiourea in hydrochloric acid solution to give a blue color. The blue color obtained on heating with dithiooxamide in hydrochloric acid solution is very specific.

Osmium reacts with thiourea to give a red color. The odor of osmium tetroxide is also characteristic.

In the PGM industry, physical methods are used almost exclusively for qualitative analysis. These include UV emission spectrophotometry, X-ray fluorescence analysis, inductively coupled plasma (ICP) emission spectroscopy, and atomic absorption spectroscopy.

**Chemical Assay Methods.** The methods of analysis used when buying and selling crude products, alloys, compounds, etc., must be of a very high standard because of the high value of platinum group metals. For commonly occurring combinations of elements, mandatory methods of analysis and sampling have been developed. The following methods of separation are standard and are still used today to a considerable extent. Platinum group metals are often subjected to preliminary docimastic concentration prior to assaying and are always brought into solution.

**Platinum Metals-Base Metals.** Platinum is precipitated as  $(\text{NH}_4)_2[\text{PtCl}_6]$  from a nitrate-free solution of  $\text{H}_2[\text{PtCl}_6]$  by addition of  $\text{NH}_4\text{Cl}$ , and the precipitate is heated strongly, which converts it to platinum, and then weighed. Platinum remaining in the mother liquor is precipitated as the sulfide with  $\text{H}_2\text{S}$  and carefully roasted. The heavy-metal sulfides are dissolved in 10%  $\text{HNO}_3$ , and the residue is treated with  $\text{H}_2\text{SO}_4\text{-HF}$  and weighed as platinum. For Pt- $\alpha\text{-Al}_2\text{O}_3$  catalysts used in the petroleum industry, the mandatory method of determining platinum is by the coloration produced with tin(II) chloride, which is determined photometrically after extraction with ethyl acetate.

**Platinum-Rhodium.** A finely divided metal black is obtained by fusion with zinc followed by treatment with hydrochloric acid. Platinum is dissolved in aqua regia, and  $(\text{NH}_4)_2[\text{PtCl}_6]$  is precipitated and heated strongly to yield platinum. The remaining noble metal is cemented from the mother liquor, combined with the residue remaining after aqua regia treatment, and treated with chlorine

at 650–700 °C. The  $\text{RhCl}_3$  obtained, which is insoluble in aqua regia, is heated strongly in a hydrogen atmosphere to produce the metal, which is weighed. Base metals remain in solution with some residual platinum. The latter is isolated by precipitation as sulfide, and the figure obtained is included with the main amount.

**Platinum-Palladium.** Palladium is quantitatively precipitated by dimethylglyoxime from a dilute solution in aqua regia. It is filtered off, washed thoroughly, calcined carefully, reduced to the metal by hydrogen, and weighed. The dimethylglyoxime in solution is decomposed by aqua regia, and platinum is converted to  $(\text{NH}_4)_2[\text{PtCl}_6]$ , precipitated as sulfide, isolated as the metal, and weighed.

**Platinum-Iridium.** Platinum-iridium is converted into a finely divided state by fusion with zinc, and the platinum is dissolved with aqua regia. Iridium remains undissolved and, after reduction with hydrogen, is weighed.

**Pt-Pd-Rh-Ir-Ru-Os-Au Ore Concentrates.** After being melted with zinc in a stream of hydrogen, the alloy is dissolved in hydrochloric acid, and the metal black is isolated. The  $\text{OsO}_4$  is driven off by heating to 1000 °C in a stream of oxygen. The metal that remains after removal of osmium is reduced in a stream of  $\text{H}_2$  and rendered soluble by fusion with  $\text{KOH-KNO}_3$ .

The fusion product is dissolved in water;  $\text{RuO}_4$  is distilled from the solution in the presence of an oxidizing agent (e.g.,  $\text{Cl}_2$ ) collected in a receiver containing an alcoholic solution of hydrogen chloride, and finally weighed as metal. The distillation residue is reduced to the noble metals by treatment with  $\text{NaOH}$  and ethanol, filtered off, and heated gently in a stream of  $\text{H}_2$ . It is then dissolved in aqua regia, and the insoluble residue is filtered. Gold is then determined with oxalic acid and palladium with dimethylglyoxime. The remaining noble metal is obtained by cementation with zinc and combined with the insoluble aqua regia residue. A further fusion with zinc is carried out, followed by final treatment with hydrochloric acid. Dry chlorination at 650 °C produces platinum chloride, which is dissolved in

33% aqua regia. The residue is treated with  $\text{NaCl}$  and  $\text{Cl}_2$  at 650 °C; the product is dissolved in water and acidified, precipitating  $(\text{NH}_4)_2[\text{IrCl}_6]$ , and rhodium is cemented from the solution with zinc. The product is then chlorinated at 650 °C. This again extracts platinum, and the solution is combined with the other solution, which contains most of the platinum. Platinum is determined by precipitating  $(\text{NH}_4)_2[\text{PtCl}_6]$ , and rhodium by reduction of the  $\text{RhCl}_3$  residue.

The platinum content of commercial compounds and preparations is usually determined reduction with hydrazine. Cementation from solution in strong hydrochloric acid by treatment with zinc turnings is an exact method if carefully carried out.

**Physical Methods.** Physical methods—especially spectroscopic ones—are increasingly being used, because they are inexpensive and, with improvements in the equipment, have sufficient accuracy for accounting purposes. If the PGMs are brought into solution by suitable fusion and separation methods, all the metals can be determined in the presence of each other by X-ray fluorescence or ICP analysis, for example. The former can also be used for direct analysis of metallic materials with sufficient accuracy for production control in the manufacture of defined alloys. Calibration of this method, when used on higher alloys, is, however, difficult.

## 25.9 Uses [3, 5, 29, 30, 180]

### 25.9.1 Jewelry, Coinage, Investment [158]

In recent decades, platinum has been in such demand for jewelry and high-quality watchmaking that more than one-third of all the platinum consumed has been used for this purpose. Of this amount, Japan uses about 90%, with the United States taking the next largest share. Most of the alloys employed contain 95% platinum and are stamped PLAT 950. The mechanically more stable alloys Pt95-Cu5, Pt96-Pd4, and Pt90-Ir10 are used

for mounting precious stones. Forming costs for platinum are considerably higher than those for gold because the metal is more difficult to work, and recycling costs are high. These factors markedly affect total cost.

Very good resistance to corrosion and erosion is required of alloys used for the nib tips of high-quality fountain pens [158]. These alloys are based on ruthenium, iridium, and osmium.

In the Russian Empire in 1828–1845, a total of 15 t of platinum was formed into 3-, 6-, and 12-ruble pieces by sintering, minted, and brought into circulation.

The fineness was 99% platinum or 99.2% PGM [15]. Between 1977 and 1980, platinum coins were again minted for the Moscow Olympic Games. These were 150-ruble pieces, fineness: 9999, 1/2 ounce, in five designs. Since then, platinum coins have been officially minted in other states (e.g., a Platinum Noble in the UK, a Platinum Maple Leaf in Canada, and a Platinum Koala in Australia). The standard issue of all these coins contained one troy ounce (31.1035 g) of fine platinum. Small ingots, usually containing 99.995% platinum, are also minted, intended mainly for small investors. The use of palladium for this purpose has recently begun on a small scale.

### 25.9.2 Apparatus [181–184]

**Laboratory Technology.** Platinum crucibles, dishes, boats, and electrodes (for electrogravimetry) have long been basic items of equipment in chemical laboratories. In earlier times, the purity of platinum was variable. Moreover, equipment made of pure platinum is not dimensionally stable, so today the more stable alloys Pt97-Ir3, Pt95-Au5, and occasionally Pt99.7-Ir0.3, are mainly used [185].

Another type of dimensionally stable platinum is dispersion-hardened platinum, which contains ca. 100 ppm of high-melting oxide (e.g.,  $\text{ZrO}_2$ ) in finely divided form [85]. The presence of this material reduces the mobility of crystal imperfections. It is produced by coprecipitation followed by sintering of the powder. The metal can be unalloyed platinum, or

alloys of platinum with rhodium or gold. Rhodium and iridium crucibles can resist extremely aggressive conditions in nonoxidizing atmospheres.

**Chemical and Electrochemical Apparatus** [186]. The platinum metals and their compounds are of limited use in chemical process technology owing to their high cost. However, platinum components are essential in fluorine chemistry. Bursting disks for protection against excessive pressure are occasionally made of platinum or palladium. Single crystals for the optical industry and for laser technology are grown in crucibles of platinum, rhodium, or (most commonly) iridium. For the electrochemical production of peroxy compounds, such as hydrogen peroxide and peroxosulfate, massive platinum anodes or hollow platinum wires are used, although such use has decreased.

**Glass Technology** [186–189]. The corrosion and erosion resistance of platinum metals toward molten glass is not matched by any other material [85]. High-purity optical glass is best melted in crucibles of unalloyed platinum. Special iron-free glass for sodium vapor lamps, X-ray windows, and cathode-ray tubes is melted in Pt–Rh vessels.

In the automated production of bottles by large holding furnaces, the use of platinum components ensures problem-free operation over long periods. These components include skimmers, pouring funnels, thermocouple protection tubes, and level-measuring devices. Dispersion-hardened platinum has also recently been used in glassmaking technology.

In the manufacture of glass fibers and glass wool, the spinnerets are made of Pt–Rh. Rock wool and slag wool are made by a centrifugal spinning process with platinum centrifuges.

**Textile Technology.** Nozzles made of platinum alloys such as Au70–Pt30 and Pt92–Ir8 are used for spinning viscose fibers [190].

**Soldering Materials.** Gold and palladium have been used in some special solders.

**Nuclear Technology.** In recently published research, a deuterium-saturated Pd–Ag target was claimed to catalyze a controlled deuterium–deuterium fusion reaction.

### 25.9.3 Heterogeneous Catalysts

[191–196]

All platinum group metals have strong catalytic activity, especially for hydrogenation reactions. These heterogeneous catalysts, including supported catalysts, are of major importance in chemical technology. As of 1992, ca. 200 t of platinum group metals are in use worldwide in the form of supported catalysts. Next in order of importance are bulk metallic catalysts in the form of wire gauzes, highly dispersed carrier-free metals, and oxides. Platinum and palladium are much more important than rhodium, ruthenium, iridium, and osmium. Often, two or more platinum group metals are combined (Table 25.6).

**Supported Catalysts.** The properties of supported catalysts are very dependent on the interaction between noble-metal catalysts and support material. Classical support materials were asbestos and pumice stone. Important support materials today include aluminum oxides, activated carbon, silicates (e.g., zeolites), and silicic acid.

Powdered support materials are used as suspension catalysts; porous pressed shapes or pellets are used for fixed-bed catalyst.

The largest demand for platinum catalysts comes from the petroleum industry [197, 198]. These are used in reforming high-boiling fractions from the distillation of crude oil at atmospheric pressure. The most important reactions are the dehydrogenation of alkylcyclohexanes, the isomerization and dehydrogenation of alkylcyclopentanes, and the dehydrogenation and cyclization of alkanes, all of which form aromatics, as well as hydrogenative cleavage of alkanes and naphthenes, and dealkylation of alkylaromatics. The resulting product mixtures are gasolines with high antiknock properties. The most important catalysts are Pt– $\gamma$ -Al<sub>2</sub>O<sub>3</sub>.

Table 25.6: Modification of the catalytic activity of the platinum group metals by additional metals.

Base metal	Additional metal	Reaction	Effect of additive
Pt	5–20% Rh	ammonia oxidation	increased NO yield lower Pt losses
Pt	Ge, Sn, In, Ga	dehydration and hydrocracking of alkanes	longer catalyst life due to fewer deposits
Pt	Sn + Re	dehydrocyclization and aromatization of alkanes	increased catalyst activity and stability
Pt	Pb, Cu	dehydrocyclization and aromatization of alkanes	effective aromatization
Pt, Pd, Ir	Au	oxidative dehydrogenation of alkanes, <i>n</i> -butene to butadiene	better selectivity
Ru, Os	Cu(Ag)	reforming	less hydrogenation relative to isomerization
Ir	Au(Ag, Cu)	hydroforming of paraffins and cycloalkanes	high yield of aromatics above 500 °C
Pd	Sn, Zn, Pb	selective hydrogenation of alkynes to alkenes	
Pd	Ni, Rh, Ag	alkane dehydrogenation and dehydrocyclization	hinders coking

Combinations of metals such as platinum–rhenium, platinum–iridium, platinum–palladium, and platinum–germanium are also used.

Another use for PGM catalysts in the petroleum industry is in hydrotreating processes. In addition to base-metal catalysts, platinum and palladium catalysts supported on  $\gamma$ -Al<sub>2</sub>O<sub>3</sub> or aluminum silicates (zeolites) are used. In the pharmaceutical industry, palladium active carbon hydrogenation catalysts are widely used, mainly with a palladium content of 5%. Other catalysts used include rhodium–active carbon, platinum–active carbon, and palladium–platinum–active carbon.

**Solid Metal Catalysts** [199–202]. Platinum–rhodium gauzes are used as catalysts for the large-scale oxidation of ammonia to nitric oxide (Ostwald and Brauer process) in the manufacture of nitric acid.

The oxidation reaction

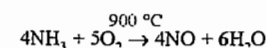

takes place in reactors in which many fine-mesh gauzes are stacked above one another. The rate of loss of noble metal varies between 0.2 and 2.0 g per tonne of nitrogen reacted, depending on process conditions. If a rhodium–platinum alloy is used, the rate of loss of noble metal is reduced; powdering of the gauze takes place more slowly, and its lifetime is increased.

In the production of hydrogen cyanide (Andrussow process),

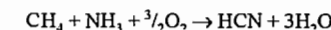

platinum–rhodium or platinum–iridium gauzes are used as catalysts.

The Degussa process

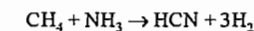

uses  $\alpha$ -Al<sub>2</sub>O<sub>3</sub> tubes coated on the inside with platinum film.

**Finely Divided Metallic Catalysts.** The so-called platinum metal blacks are well-established catalysts for hydrogenation, dehydrogenation, and oxidation, mainly on a laboratory scale. Their high degree of dispersion is shown by their large specific surface (> 100 m<sup>2</sup>/g). These catalysts are very active even at low temperature, so reactions with labile molecules are possible. In the production of hydrogen peroxide by the anthraquinone process, palladium black is used to a considerable extent in suspension in a nonaqueous medium or as a fixed bed to catalyze the reduction of alkylanthraquinone to the corresponding hydroquinone. The platinum oxide PtO·2H<sub>2</sub>O (Adam's catalyst) is used widely as an unsupported catalyst in the pharmaceutical industry for the hydrogenation of alkenes and carbonyl groups. Nishimura's catalyst contains rhodium oxide in addition to platinum oxide. Platinum on electrically conducting carbon black is used as a catalyst in fuel cells.

**Catalyst Poisoning and Regeneration** [203]. All catalysts are liable to be deactivated (poisoned) by chemical, mechanical, and thermal means. Typical contact poisons for platinum group metals include sulfur, phosphorus, carbon monoxide, hydrogen cyanide, lead, and mercury.

Reactivation is often possible, especially with supported catalysts, by heating, steam treatment, reaction with oxidizing or reducing gases, or washing.

### 25.9.4 Homogeneous Catalysts

[29, 85, 204–206]

Homogeneous catalysis by platinum group metals, especially rhodium, has made a major impact in industrial chemistry. Important characteristics of these catalysts include high activity and, therefore, low concentration; high selectivity leading to absence of side products; and mild reaction conditions, enabling the use of low temperature and pressure and facilitating the control of reaction conditions. These factors are of great importance and allow expensive PGMs to be used economically. The discovery of chloro-*tris*-(triphenylphosphine)rhodium(I),  $[\text{RhCl}(\text{P}(\text{C}_6\text{H}_5)_3)_3]$ , a highly effective hydrogenation catalyst, by WILKINSON [207] opened a new chapter in homogeneous catalysis and in the complex chemistry of rhodium. Today, a number of modified complexes of this and similar types are known.

Homogeneous catalysis by rhodium complexes in oxo synthesis (hydroformylation) has attained great importance and made possible the synthesis of industrially important aldehydes from alkenes. This process was formerly carried out with homogeneous cobalt catalysts. Initially,  $[\text{RhCl}(\text{P}(\text{C}_6\text{H}_5)_3)_3]$  was used as catalyst; subsequently, halogen-free catalysts were introduced. Some of these can be used at room temperature, whereas cobalt complexes require temperatures up to 200 °C, necessitating the use of high-pressure reactors. Generally, the catalytically active compound is not manufactured. Instead, other compounds are used as precursors from which the

actual catalyst is formed during the reaction. These include  $[\text{Rh}(\text{CO})_2 \text{ acac}]$ ,  $[\text{Rh}\{\text{P}(\text{C}_6\text{H}_5)_3\}(\text{CO}) \text{ acac}]$ , and  $[\text{Rh}(\text{CO})_2 \text{ Cl}]_2$ , which form the catalyst  $[\text{RhH}(\text{CO})\{\text{P}(\text{C}_6\text{H}_5)_3\}_3]$ .

The Monsanto acetic acid process uses Rh(III) iodide as the catalyst precursor.

In silicone chemistry, hydrosilylation is carried out with homogeneous PGM catalysts [208].

Enantiomerically pure products are prepared by stereospecific hydrogenation with chiral noble-metal complexes as homogeneous catalysts [208]. The substrates are usually steroids or amino acid derivatives. Asymmetrically catalyzed reactions are used mainly in the production of pharmaceuticals. For example, asymmetric hydrogenation is used in the synthesis of L-dopa, a drug for the treatment of Parkinson's disease. These catalysts are modified Wilkinson catalysts in which  $\text{PPh}_3$  is replaced by an optically active diphosphine ligand. The catalyst was previously formed in situ by reacting the readily obtainable  $\text{Rh}(\text{diene})\text{Cl}_2$  complex with the required chiral phosphine. Cationic complexes with a chiral phosphine are also used. These have extremely high activity.

Osmium(VIII) oxide and ruthenium(VIII) oxide have long been used as homogeneous catalysts for hydroxylation, oxidation, and epoxidation. Palladium(II) chloride and tetrachloropalladic(II) acid are important homogeneous catalysts used in the large-scale oxidation of ethylene to acetaldehyde in the Wacker process.

### 25.9.5 Automobile Exhaust Catalysts

[31, 209–212]

The use of supported noble-metal catalysts for the treatment of exhaust gases from automobiles has been introduced in recent years in all industrialized countries. Regulations controlling the quality of exhaust gases can be complied with only by the use of such catalysts. In particular, carbon monoxide (CO), hydrocarbons ( $\text{CH}_x$ ), and nitrogen oxides ( $\text{NO}_x$ ) must be reduced to one-tenth of their

initial concentrations. Combinations of metals that have a catalytic action on exhaust gases include Pt–Rh, Pt–Pd, and Pt–Pd–Rh.

Combinations that can reduce all three harmful components are known as three-way catalysts. The three-way technique also includes control of the air–fuel ratio by means of a  $\lambda$ -probe (see Section 25.9.6). Exhaust-gas catalysts have their optimum activity only if the engine and the catalytic unit are matched. Two principal types are used. In one of these, the exhaust gas passes through catalyst pellets, and in the other “monolithic” or ceramic type, the gases pass through numerous parallel channels through extruded bodies that are coated with a catalytically active layer of PGM– $\gamma$ - $\text{Al}_2\text{O}_3$ . The ceramic support material is cordierite. Recently, sheet steel labyrinths have been used with improved heat-transfer characteristics, especially on starting; their main advantage is the lower pressure drop across the catalyst. An improvement in exhaust-gas specifications is currently under consideration, so exhaust-gas catalyst systems will have an even more important role to play in the future.

Each catalytic converter contains ca. 2 g Pt–Rh or Pt–Pd (i.e., 0.05% of the pellets, or 0.5% if the support consists of cordierite). The demand for these materials worldwide amounts to more than one-third of the annual production of platinum and more than four-fifths of the annual production of rhodium. The PGM catalysts are at present the only practical materials for this purpose.

The required lifetime of an exhaust-gas catalyst, as laid down by the widely accepted U.S. standard, corresponds to 80 000 km.

Three-way catalysts, used in conjunction with  $\lambda$ -probes, are also employed in thermal power stations. Here, lifetimes are considerably longer because of the steady loads and the absence of mechanical disturbance.

Catalysts similar to those used for the treatment of automobile exhaust gases are also used to treat industrial waste gases contaminated with harmful organic materials.

### 25.9.6 Sensors [29, 85, 158]

Platinum metals and their alloys are widely used in thermocouples (Table 25.7), because these have longer lifetimes than those made of base metals and can be used at higher temperature. The most important thermocouple element pair used in industry is Pt90/Rh10–Pt (wire thickness: ca. 0.5 mm), which gives accurate temperature measurements over the range 800–1600 °C.

Table 25.7: Commonly used noble metal thermocouple pairs.

Positive leg	Negative leg	Operating temperature
Cu	Au99.4 Co0.6	–240 to 0 °C
Pt90 Ir10	Au60 Pd40	0 to 700 °C
Pt90 Rh10	Pt	850 to 1600 °C
Pt70 Rh30	Pt94 Rh6	1000 to 2800 °C
Rh40 Ir60	Ir	1000 to 2200 °C

**Resistance Thermometry.** The electrical resistance of metals increases with increasing temperature. Because of this, pure, chemically stable metals that undergo no aging over a wide temperature range can be used to construct temperature-sensitive devices that are stable for long periods. Platinum is very suitable for this application. The changes in its resistance over certain temperature ranges (e.g., between –200 and +850 °C) have been specified in standards.

Platinum wire-wound resistors, whose resistance is determined by the length and cross section of the wire, have been almost completely displaced by so-called thin-film resistors, manufactured by thin-film technology. A film of platinum ca. 1  $\mu\text{m}$  thick is deposited on an insulating ceramic substrate by vacuum deposition or cathodic sputtering. A meandering resistance path is formed in the film of noble metal by cutting with a laser beam or by ionic etching through a masking coating produced by photolithography. The thickness of the film and the total path length determine the resistance at 0 °C. Path widths are in the region of 20  $\mu\text{m}$ . The connecting leads, which are joined to the thin film by special bonding processes, also consist of noble metals or their compounds. Modern resistance thermometers

based on thin-film technology have the advantage over wire-wound resistance thermometers because they can be manufactured by highly automated methods and require only small amounts of PGM (< 1 mg per device).

Resistance thermometers are used today in a wide range of technologies, from household appliances to chemical equipment, and from road transportation to air and space travel.

**Gas Sensors (Lambda Probes).** Oxygen sensors utilize the high electrical conductivity imparted to solid electrolytes (e.g.,  $ZrO_2$ ) by the presence of oxygen ions, compared to their normal conductivity due to electrons. If this ionic conductor acts as a separator between two gas spaces, and if it is provided with platinum electrodes on both sides, a difference in the oxygen partial pressure causes a so-called Nernst emf to be produced between the electrodes. These probes are used to control the fuel-air mixture in conjunction with automobile exhaust-gas catalysts in Otto engines.

Noble-metal catalysts are also used in sensors for detecting combustible gases in air or explosive gas mixtures. Heat evolution is normally detected by sensors known as Pellistors, which consist of platinum wire in a small sphere of  $Al_2O_3$  (diameter: 1.5 mm). The sphere is saturated with a noble-metal catalyst. If a chemical reaction takes place on the catalyst, a temperature increase occurs that can be measured by the change in resistance of the platinum wire. These heat evolution sensors are used in explosion protection equipment.

### 25.9.7 Electrical Technology

[181, 213]

In low-current technology, electrical contacts of gold, silver, palladium, rhodium, platinum, and their alloys are used. Contacts made of bulk noble metals are becoming less common than those coated by electrolytic and mechanical processes.

For a long time, large numbers of so-called reed contacts have been used in telephone relays. These are Ag-Pd-, rhodium-, or ruthenium-coated contacts operating under a

protective gas. Such contacts must be resistant to sparking, corrosion, and erosion, and must not become welded together. During a lifetime of 30 years, they must carry out millions of switching operations without damage. Furthermore, their contact resistance must be low, and their nominal resistance must be constant.

Platinum sealing wires are also now used only for specialty light bulbs and transmitter tubes. Heating elements made of platinum metals or their compounds are used in resistance-heated furnaces above 1200 °C. Windings of Pt70-Rh30 can be used up to 1500 °C, and ribbon windings of rhodium up to 1800 °C. Furnace elements made of platinum metals can be used without a protective gas. Platinum, rhodium, iridium, and ruthenium are used as susceptor materials in induction furnaces.

Platinum-iridium alloys are useful for spark plug contacts for high-power airplane and automobile engines.

### 25.9.8 Electronics [29, 85, 158]

In modern electronics, noble-metal pastes, including those of the platinum group metals and their alloys, are key products in the production of many important components. They are used in active components such as diodes, transistors, integrated circuits, thick-film hybrid circuits, and semiconductor memories, and are also used in passive electronic components such as very small multilayer capacitors, thick-film resistors, and conductors. The metallization process is generally carried out with Ag-Pd paste, and occasionally with Ag-Pt paste. Printed resistors use  $RuO_2$  as the conducting pigment.

The metal powder pastes can be used in the form of drying preparations, baking preparations, or soldering pastes, depending on the application. All types contain an organic binder that melts during baking. The baking preparations usually also contain powdered glass as an adhesive. The pastes are generally applied to the substrate by screen printing, although soldering pastes have recently been applied via a stencil. The edge regions of

multilayer capacitors are prepared for metallization by a dipping process.

The powders used in the pastes are generally produced by reduction. Bimetallic powders are produced by mechanical mixing to give composite blends or by coprecipitation. Their specific surface area is usually ca. 1  $m^2/g$ . The particle shape can be spheroidal, microcrystalline, or laminar. The substrate is usually  $\alpha-Al_2O_3$ .

Thin-film technology is used in microelectronics (see Section 25.9.9), although noble metals are not used to the same extent here as in thick-film technology.

### 25.9.9 Coatings [29, 30, 86, 158]

Coatings of platinum metals may be applied to a substrate by various methods.

#### 25.9.9.1 Coatings Produced by Aqueous Electrolysis [214]

**Platinum.** Lustrous thin films for decorative purposes are deposited from an electrolyte obtained by reacting potassium tetranitroplatinate(II),  $K_2[Pt(NO_2)_4]$ , with sulfuric acid. The active complex is  $H_2[Pt(NO_2)_2SO_4]$ . This is more stable than other platinum plating baths.

Relatively thick coatings can be deposited from alkaline solutions of sodium hexahydroxyplatinate(IV),  $Na_2[Pt(OH)_6]$ , although this electrolyte is unstable.

Platinum(II) diamminedinitrite,  $[Pt(NH_3)_2(NO_2)_2]$ , was formerly very widely used and today along with  $Na_2[Pt(OH)_6]$ , is used for coating titanium by aqueous electrolysis. These coatings are of lower quality than those produced by high-temperature electrolysis. Also, extensive pretreatment of the substrate metal is necessary, mainly to prevent cathodic absorption of hydrogen.

**Rhodium** [160]. Rhodium coatings are superior to all other PGM coatings, having better hardness, mechanical and chemical stability, and reflexivity. For these reasons, rhodium is more widely used than the other platinum group metals.

Electrolytes consisting of rhodium sulfate (10–20 g/L Rh) in sulfuric acid can give comparatively thick coatings (10–12  $\mu m$ ). Crack formation can be countered by addition of sulfite, selenic acid, magnesium sulfate, or magnesium sulfamate. These baths are used to produce rhodium coatings for heavy-duty slip ring contacts and optical reflectors, and were at one time used for reed contacts in telephone technology.

Rhodium sulfate or phosphate baths containing 2 g/L of rhodium are used for decorative purposes and give strongly reflective thin films (0.1–0.5  $\mu m$ ) that prevent silver or white gold from tarnishing. They are also used for plating eyeglass frames.

**Palladium** [159]. Palladium can sometimes replace gold in coatings for electronics. The plating batches contain palladium(II) diamminedinitrite,  $[Pd(NH_3)_2(NO_2)_2]$  (palladium P-salt), with additions of sodium and ammonium nitrates, or sulfamates.

Successful results have recently been obtained with plating baths based on organopalladium complexes. Concentrated hydrochloric acid plating baths with dissolving palladium anodes are rarely used now.

**Ruthenium** is deposited electrolytically from solutions of ruthenium complexes with a bridging nitrido ligand, for example, nitrido-octachlorodiaquodiruthenate(IV),  $H_2O \cdot [H_2O(Cl_4Ru)-N-(RuCl_4)H_2O]^{3-}$ , the basis of the so-called RuNC baths. The corresponding complex with hydroxo ligands instead of chloro ligands can also be used.

Platinum baths based on ruthenium nitrosylsulfamate are also used.

**High-Temperature Electrolysis (HTE)** [29, 85, 215–217]. Platinum group metals can be deposited electrolytically from cyanide-containing melts in which a soluble anode provides the noble metal that is deposited on the cathode. The metal most widely used in this process is platinum, although iridium is sometimes used.

The molten salt, an eutectic mixture of KCN and NaCN, is maintained at 500–600 °C

in an electrically heated crucible. The platinum is deposited from the melt onto the substrate, which forms the cathode in the electric circuit.

Process parameters are as follows:

Electrolyte	$K_2[Pt(CN)_4]$ in KCN-NaCN
Operating temperature	500–600 °C
Deposition voltage	0.1–2 V
Cathodic current density	1–5 A/m <sup>2</sup>
Cathodic current yield	> 60%
Mean rate of deposition	10–20 μm/h

Oxidation of the melt and of the metal is prevented by a protective atmosphere of high-purity argon. Suitable substrate materials for HTE platinum deposition include refractory metals such as titanium, niobium, tantalum, molybdenum, tungsten, zirconium; steels; and other metals such as copper. They must generally be pretreated by sandblasting and degreasing.

Advantages of HTE platinum coatings, compared with those produced by aqueous electrolysis, include low porosity; a wide range of film thicknesses (1–400 μm), excellent adhesion; good resistance to mechanical impact, thermal shock, and sliding wear; high thermal conductivity; and high ductility.

The largest use is in producing anodes for cathodic corrosion protection [218] (often in the form of expanded metal) or insoluble anodes for electrolytic technology. Platinum-coated molybdenum wire is used in the construction of thermionic tubes and for fusion with glass. High-temperature electrolysis is also used for electroforming.

### 25.9.9.2 Coatings Produced by Chemical Reaction [30]

Surface coatings of platinum metals can be deposited onto metallic or nonmetallic substrates by chemical reduction or thermal decomposition of PGM compounds.

Platinum acetylacetonate is used for platinization of titanium. The titanium articles are painted with a solution of this compound, dried, and heated. Repeated application is necessary. The process is not widely used due to allergic reaction and the low quality of the coatings.

Platinum coatings are produced on ceramic tubes by saturating them with hexachloroplatinic acid and heating to 600–800 °C [219]. Such tubes are used as catalysts for the synthesis of hydrogen cyanide.

Platinum metal resins are used as ceramic colorants [220, 221]. These can be employed to produce conductive platinum coatings on ceramic substrates, onto which further layers can be deposited electrolytically. Platinum coatings are also used for decorative purposes.

Hexachlororuthenic(III) acid,  $H_3[RuCl_6]$ , dissolved in alcohol, is painted onto the substrate, dried, and heated strongly in air to produce an extremely adherent coating of  $RuO_2$  [222, 223]. Titanium sheet, coated in this way, has outstanding electrochemical properties and is being used in chloralkali electrolysis as dimensionally stable anodes. The  $RuO_2$  coatings are also used in the production of circuit boards by screen printing.

### 25.9.9.3 Coatings Produced by Physical Methods [85]

Platinum can be deposited as a thin film on substrates by evaporating the metal in a high vacuum. Modern thin-film technology is based mainly on the generation of fine particles from a cathode (cathodic sputtering). Due to the high kinetic energy of these metal particles, extremely good adhesion is obtained. In the case of platinum group metals, sputtering targets are used only for microelectronics. Ion plating is also used to produce high-quality coatings.

Roll-bonded PGM coatings are no longer important.

### 25.9.10 Dental Materials [85]

Platinum and palladium have major importance in dentistry.

Up to ca. 1900, dental prostheses such as gold fillings, crowns, and bridges were made mainly of alloys with the same composition as those used in coinage and jewelry, and later of

22-carat gold (83.3%). Platinum was used only to make fixing pins.

Important quality requirements such as oral stability, biological compatibility, color, strength, and good functional properties are achieved only by modern dental alloys. These complex alloys, unlike the earlier gold-containing ones, have a very fine-grained, homogeneous crystalline structure, giving much better corrosion resistance. Also, their hardness is controllable over a wide range and can be adapted to particular requirements.

**Standard Alloys.** Modern alloys for making dentures or prostheses have compositions mainly in the range 65–85% gold, 1–10% platinum, 1–4% palladium, 10–15% silver, 0–10% copper, and 0–1% zinc.

In low-gold alloys, which are cheaper, the gold is replaced partially by silver or palladium. These alloys contain 40–60% gold, 0–2% platinum, 3–10% palladium, 23–35% silver, 0–12% copper, and 0–5% tin, indium, and zinc.

Silver-base alloys have very low gold content. Adequate oral stability can be achieved by including at least 25% platinum group metals or gold. Inexpensive alloys in this category contain at least 20–25% palladium, 0–3% gold, ca. 55–70% silver, and copper and zinc, and are therefore no longer yellow, but white.

**Alloys with ceramic veneers** are used in the production of ceramic-metal systems. This technique, in which a dental ceramic is fused onto a metal casting, has been used in dentistry for ca. 25 years. A durable and strong bond can then be produced between the tooth stump and the porcelain-metal system. The advantages of this are a natural appearance combined with compatibility with human tissue. To obtain a good bond between the metal and the ceramic, alloys must contain components that form so-called adhesive oxides when the ceramic is fired. Because firing is carried out at ca. 980 °C, the alloys must have a minimum solidus temperature of ca. 1050 °C.

Alloys with a high gold content have compositions in the range 75–90% gold, 5–10%

platinum, 1–10% palladium, 0–3% silver, with small additions of iron, indium, tin, zinc, and other elements.

Attempts have been made to reduce the cost of these alloys by replacing gold by palladium and silver. Typical Au-Pd-Ag alloys have compositions in the following range: 42–62% gold, 25–43% palladium, 5–20% silver, and 4–10% base metals such as copper, tin, indium, gallium, and zinc. Typical silver-free Au-Pd alloys have the following composition: 45–60% gold, 32–40% palladium, and 0–14% of the base metals tin, indium, zinc, or gallium.

Palladium-base dental alloys were introduced in Germany in the early 1980s. These were developed to reduce cost. Silver-free and silver-containing alloys are available. Both contain very small amounts, if any, of gold and platinum. The range of compositions for the silver-containing palladium-based alloys is 53–61% palladium, 28–38% silver, 0–12% tin, indium, zinc, and gallium. For the silver-free palladium-based alloys, the composition range is 73–88% palladium, 0–2% gold, and 12–26% of the base metals copper, cobalt, tin, indium, and gallium.

## 25.10 Economic Aspects

See references [5, 10, 23, 29, 44, 46, 55–61, 73, 211, 224–231].

### 25.10.1 Supply

The platinum group metals as a whole are of moderate importance in the world metal market as measured by the total value of the raw product obtained from the ore. This total value fluctuates according to prices, generally equaling the figure for silver, and is ca. 20% of the value of gold production. The latter amounted to ca.  $32 \times 10^6$  DM/a, and is the third most important metal in terms of value after iron and aluminum.

The primary production of platinum, palladium, and rhodium for various producing countries is listed in Table 25.8. Production figures for the former Soviet Union have



never been published: the figures indicate sales to the West.

In addition to PGMs obtained from ores, a considerable amount of secondary material exists. The extent of this is very variable and fluctuates with time.

Averaged over all the PGMs, it amounts at present to ca. 20% of primary production, with the greatest emphasis on platinum and especially palladium. The present effort directed toward recovery from spent automobile catalysts will considerably increase the proportional secondary production of platinum and rhodium.

A high proportion of the PGMs is recycled by the users or, in the case of contract suppliers of semifinished products (e.g., catalysts),

by the producers. These materials do not appear on the market either on the supply or on the demand side, so supply figures essentially reflect only mined products and sales from the former Soviet Union.

### 25.10.2 Demand

The demands of individual countries or regions, excluding the former Eastern bloc countries, for platinum, palladium, and rhodium in 1990 are indicated in Figure 25.14. This shows that, in value terms, rhodium has moved into first place for the first time (see Table 25.9 for prices).

Figure 25.15 depicts how various PGMs are divided among areas of use.

Table 25.8: Platinum, palladium, and rhodium output by regions (10<sup>3</sup> troy oz).

	1980	1981	1982	1983	1984	1985	1986	1987	1988	1989	1990
<b>Platinum</b>											
South Africa	2320	1800	1960	2070	2280	2340	2350	2520	2580	2590	2780
Soviet Union (sales)	340	370	380	290	250	230	290	400	440	550	700
Canada	130	130	120	80	150	150	150	140	145	150	185 <sup>a</sup>
Others	30	30	30	40	40	40	40	40	95 <sup>a</sup>	85 <sup>a</sup>	65
Total	2820	2330	2490	2480	2720	2760	2830	3100	3260	3375	3730
Total, t	80	73	77	77	85	86	88	96	101	105	116
<b>Palladium</b>											
South Africa					1690	1440	1600	1790	1770	1650	1850
Soviet Union (sales)	1400				950	1010	1040	1090	1105	1135	1235
Canada	200				190	190	190	190	170	205	370 <sup>a</sup>
Others	60				90	90	90	90	270 <sup>a</sup>	215	70
Total	2340				2920	2730	2920	3160	3315	3205	3525
Total, t	73				91	85	91	98	103	100	110
<b>Rhodium</b>											
South Africa					165	175	195	195	185	205	
Soviet Union (sales)					45	85	100	100	130	155	
Canada					15	15	18	20	15	17	
Others					0	0	0	0	0	0	
Total					200	225	275	313	315	330	377
Total, t					6	7	9	10	10	12	12

<sup>a</sup> Including United States.

Table 25.9: Prices of the platinum group metals and gold (rounded, DM/g).

	1st July 1983	1st Sept. 1984	15th August 1985	1st May 1986	1st Oct. 1988	1st June 1990	15th June 1991
Osmium	14	54	98	51	40	34	31
Platinum	37	34	29	28	30	28	22
Palladium	13	15	11	7	8	7	5
Rhodium	30	77	83	78	70	143	285
Iridium	31	51	42	28	20	18	16
Ruthenium	6	17	9	5	5	4	4
Gold	34	33	31	24	25	20	21

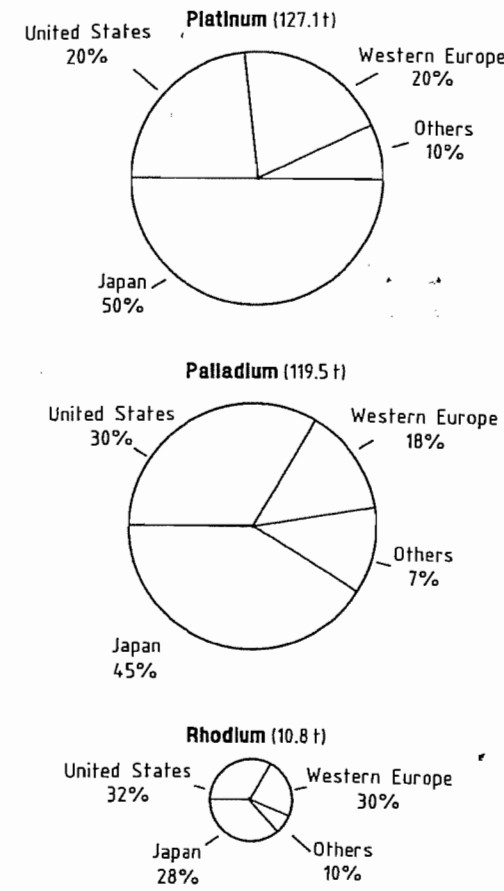

Figure 25.14: Western World demand for platinum, palladium, and rhodium (1990).

### 25.10.3 Prices

Variations in the price of platinum group metals mostly tend to be linked to the price of gold. However, the demand for platinum group metals sometimes changes rapidly, even suddenly, usually following technical innovations, and therefore extremely rapid price changes are not uncommon. This is especially true of metals other than platinum, because the availability of a given metal cannot be increased by increasing the production of that metal alone. The demand for platinum, the most abundant platinum group metal, is the most important factor in deciding whether to increase the capacity of a mine.

Table 25.9 shows changes in the price of platinum group metals over the past ten years.

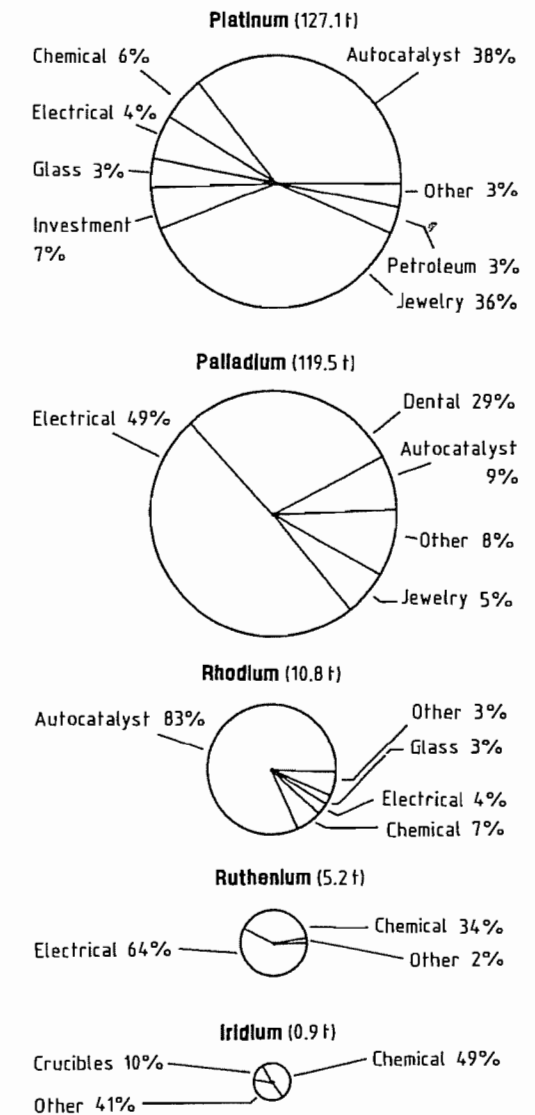

Figure 25.15: Western World platinum group metal demand according to application (1990).

### 25.10.4 Producers

For a long time, the largest producer of platinum in South Africa and the world has been Rustenburg Platinum Holdings (RPH), which was founded in 1931. Its capacity in

1992 was 46.4 t ( $1.5 \times 10^6$  troy ounces). Until 1972, only the first stages of the production of a 50–70% PGM concentrate were carried out in South Africa, while the production of pure metals was carried out by Johnson Matthey & Co., London, in their refinery in Royston, England. In 1972, Rustenburg and Johnson Matthey founded the joint subsidiary company Matthey Rustenburg Refiners, which since that time has converted all the concentrate produced in Rustenburg to pure metals. In 1989 the new SAREF refinery of RPH began operation in Bophuthatswana and is now the only Refinery in the RPH group.

In 1969, Impala Platinum became a new producer of platinum. From the beginning, this company concentrated on the complete process of production of pure metal in South Africa. The production capacity is ca. 32 t/a.

Another newcomer among South African platinum producers is Western Platinum, a company managed jointly by Lonrho and the Canadian company Falconbridge, and almost completely owned by Lonrho, which took over Falconbridge in 1987. The production capacity, which started at 85 000 troy ounces (2.7 t) of PGMs per year, is now estimated to have increased to 500 000 troy ounces (15 t).

More recently, Gold Fields South Africa (located mainly at the head office of the Anglo-American Corp. of South Africa) has become a major PGM producer, with a planned annual capacity of 10.6 t PGM.

Many small firms, mostly in Southern Africa, extract PGM more or less independently, sometimes carrying out only part of the process. In the meantime, most of these, such as Anglo-Transvaal Consolidated Investment (Anglovaal), and their subsidiaries Atok Platinum Mines, Messina, and Lebowa Platinum have been taken over by the major producers. The Barplats Crocodile River Mine (formerly Lefkochrysos) was closed down soon after being taken over by Impala in 1991 because it was not profitable.

Since 19827 the Stillwater Mining Company in Stillwater (United States), the most recent producer, has established 19 production plants, with an annual capacity estimated at

50 000 troy ounces (1.6 t) of platinum, and ca. 180 000 troy ounces (6 t) of palladium.

Canadian PGM-bearing nickel ores have been worked since 18907 mainly by Mond Nickel Co. (from 1961) and International Nickel Co. (Mond) Ltd. (INCO), London, later in association with INCO (Canada). Since 1925, platinum group metals have been produced in the refinery in Acton, London.

Another important producer of platinum is Falconbridge Nickel Mines, Toronto, which formerly owned a refinery in Kristiansund, Norway, although this produces only platinum and palladium as pure metals.

No reliable information is available about the capacity of Russian platinum production, which is mainly a by-product of nickel production, with the main production center in Norilsk and smaller production centers in the Urals.

### 25.10.5 Commercial Aspects

The more important PGM producers sell their product through agents (i.e., not via the commodity exchange). The agent for Rustenburg material is Johnson Matthey VCC, London. Impala uses Ayrton Metals Ltd., London, and INCO uses Engelhard, New York. The other producers sell the PGMs themselves.

For platinum, and to a limited extent other PGMs, so-called producer prices have existed alongside free market prices for large industrial consumers for some decades. These prices are established by contract and are normally well below those of the free market. The main aim was to maintain a cautious pricing policy to discourage any active search for substitute materials. Around 1980, the largest South African PGM producer, Rustenburg Platinum Mines, abandoned this pricing policy, which had been in force for a long time. Its selling agents now publish daily prices that are closely linked to the market.

Since 1975, the so-called London free market price for platinum is calculated and published twice daily. Since 1976, a London palladium quotation has also been available. Both of these were only price indications, not

to be compared with the fixed quotations for gold and silver. The London Platinum and Palladium Market has since been established and publishes fixed quotations twice daily.

Platinum and palladium are also traded on the New York Mercantile exchange; platinum is also traded on the TOCM in Tokyo.

Trading in platinum on the New York exchange is in the form of contracts for units of 50 troy ounces. The purity of platinum supplied in fulfillment of such a contract must be at least 99.9%, and the platinum must originate from a producer or assayer registered with the exchange. For palladium, the contract amount is 100 troy ounces, and the purity must be 99.9%.

Spot transactions (immediate delivery and payment) are guided by the London quotation and the New York exchange quotation.

## 25.11 Health and Safety

### 25.11.1 Toxicology [35, 36]

The physiological effects of platinum group metals on the human body have been extensively investigated (Figure 25.16), particularly due to the use of PGMs in automobile catalytic converters, which leads to widespread exposure of the general public.

**Platinum Allergy** [232, 233]. Contact with platinum compounds, mainly of the hexachloroplatinate type, has long been known to lead to strong allergic reactions.

Approximately half of the people exposed experience symptoms. These range from irritation of the skin to rhinitis, and sometimes severe asthma attacks. Allergic reaction seldom occurs immediately. It usually becomes noticeable after weeks, months or, sometimes years. People suffering from other allergies are more rapidly and seriously affected, and existence of a platinum allergy often results in increased sensitivity toward other allergens. Once sensitivity has been acquired, it can remain for life. In general, if a platinum allergy is present, the only effective countermeasure is a change of workplace. Sensitivity can be

detected in advance by allergen tests (smearing the skin with a solution of hexachloroplatinate). Protective measures taken at the workplace include the installation of effective waste-gas extraction systems, and hermetic sealing of all containers and apparatus. All processes that produce dust or aerosols must be contained. This applies to every operation involving hot solutions of hexachloroplatinic(IV) acid or its salts, pyrolytic decomposition reactions, and pouring of fine crystals and solutions.

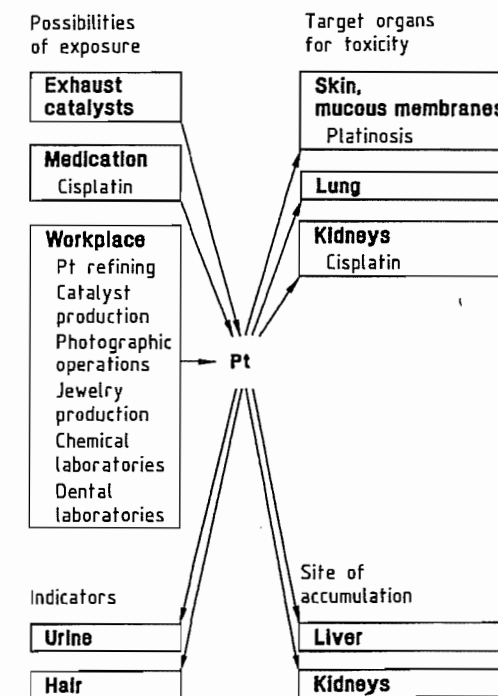

Figure 25.16: Schematic representation of the toxic effects of platinum.

Other platinum compounds have not been found to have definite allergenic properties, probably because they are not handled to a comparable extent. Metallic platinum is regarded as harmless, even in finely divided form. Compounds of other elements of the platinum group do not cause health problems of this type.

**Toxicity.** Soluble platinum compounds cause symptoms similar to those produced by other

heavy metals when taken orally. The main symptoms are violent vomiting and impairment of kidney function. Acute toxic symptoms of this kind, which often severely distress the patient, are frequently observed during the treatment of tumors by *cis* platinum. Here, the maximum dose rate is ca. 120 mg of platinum per square meter body surface per day [234].

Osmium(VIII) oxide, which is very volatile, is very toxic, has a strong irritant effect on the mucous membranes, and causes headaches [235]. Ruthenium(VIII) oxide produces similar symptoms. When OsO<sub>4</sub> is present in the atmosphere, it affects the mucous membrane of the eye, producing a characteristic symptom (i.e., the appearance of haloes around lights) caused by cloudiness of the cornea. Considerable deterioration of vision can occur, which may lead to serious hazard when driving at night.

The MAK values for platinum compounds are 0.002 mg/m<sup>3</sup> (calculated as Pt); for rhodium compounds: 0.001 mg/m<sup>3</sup> (calculated as Rh); and for OsO<sub>4</sub>: 0.002 mg/m<sup>3</sup> (0.0002 ppm).

**Automobile Exhaust Catalysts** [236, 237]. When automobile exhaust catalysts are used, some emission of platinum group metals, especially platinum, must take place. Rhodium and palladium can also be emitted. The noble metals present are 90% in the elemental state, 20% of which is respirable. Studies are yielding consistent results and give no indication of a health hazard from automobile catalysts. Some published theories that conflict with this are not borne out by the facts. Undoubted health benefits can be gained by preventing the emission of nitrogen oxides, hydrocarbons, and carbon monoxide through use of automobile exhaust catalysts.

### 25.11.2 Explosion Hazards [238]

**Alloy Formation.** The formation of some intermetallic phases is accompanied by considerable heat evolution. Violent reactions may occur between platinum or ruthenium, and

lithium, titanium, or arsenic, for example, especially when finely powdered, sometimes with explosive effect. Initiation can take place by ignition of exposed surfaces of compacted material.

**Spontaneous Decomposition.** Some complexes of platinum group metals, like explosives, contain both oxidizing and oxidizable groups. These include all PGM complexes containing ammonium and nitrate [e.g., Pt(NH<sub>3</sub>)<sub>4</sub>(NO<sub>3</sub>)<sub>2</sub>], ammonium and nitro ligands (e.g., (NH<sub>4</sub>)<sub>2</sub>[Pt(NO<sub>2</sub>)<sub>4</sub>]), and mixed-ligand complexes such as [Pt(NH<sub>3</sub>)<sub>2</sub>(NO<sub>2</sub>)<sub>2</sub>].

In standard BAM explosion tests, some of these compounds give higher values than the well-known explosive ammonium nitrate. They are sensitive to impact and decompose at impact energies of more than 10 J (corresponding to a 5-kg weight falling through 20 cm in the falling hammer test).

They can explode on impact or even on grinding of crystal agglomerates. These compounds should therefore be handled in the form of aqueous solutions. Some PGM-containing homogeneous catalysts may ignite as a result of friction.

Ruthenium(VIII) oxide, RuO<sub>4</sub>, is produced during the separation of platinum group metals and is removed by distillation. It can undergo spontaneous explosive decomposition near its boiling point or at 100 °C. Quantities of several gram should only be steam distilled. Ruthenium(VIII) oxide should not be stored in either the solid or the liquid state (*mp* 25 °C) owing to its explosive potential. The compound OsO<sub>4</sub> is much more stable than RuO<sub>4</sub>.

**Oxidative Properties.** The oxides of the platinum group metals are generally exothermic compounds. Therefore, most of them are strong oxidizing agents that can react explosively with organic substances or other reducible materials. Ruthenium(VIII) oxide is a very strong oxidizing agent. It reacts, for example, with organic materials such as filter paper, alcohol, ammonium compounds, grease for glass stoppers, or residues in dirty containers, sometimes with explosive violence.

**Hydrogen Explosions.** The greatest danger of explosion involving platinum group metals arises from their hydrogen content, which is often high, especially when the metals are in the form of highly dispersed powders. Hydrogen is present in the form of metallic hydrides, which are usually nonstoichiometric. Upon minor external influences (e.g., shock), free hydrogen can be released suddenly, mix with atmospheric oxygen, and lead to a violent explosion catalyzed by the noble metal. The capacity of all PGMs to absorb hydrogen is very high (Table 25.10).

**Table 25.10:** Binding and release of hydrogen by platinum group metals.

Element	mL H <sub>2</sub> bound per g metal	Stoichiometry	Resulting H <sub>2</sub> -O <sub>2</sub> mixture, L/g metal
Ru	123	RuH <sub>1.1</sub>	3.1
Rh	24	RhH <sub>0.2</sub>	0.6
Pd	75	PdH <sub>0.7</sub>	1.8
Os	7.5	OsH <sub>1.2</sub>	1.8
Ir	35	IrH <sub>0.6</sub>	0.9
Pt	2.4	PtH <sub>0.04</sub>	0.06

Platinum metals produced by reduction of their compounds at low temperature have a high capacity to absorb hydrogen formed as a by-product. The formation of ruthenium by reduction with sodium borohydride is especially critical. Ruthenium black is common cause of accidents. Detonation can occur on contact with water or stirring with a spatula, even with material that has been stored for a long time. Many accidents have occurred after alloying iridium, platinum, or rhodium with zinc, followed by dissolution of the zinc with acid.

Spent platinum oxide catalysts often contain hydrogen and sometimes explode on mechanical handling. Hydrogen oxygen, hydrogen chlorine, and some gas air mixtures explode immediately in the presence of noble metals without any ignition source.

**Flammability.** Platinum, palladium, and iridium are pyrophoric when sufficiently finely divided because oxide formation by reaction with air is strongly exothermic. Organic solvents, paper, and active carbon can ignite on contact with pyrophoric platinum metals. Great care must be taken when drying spent

noble metal carbon catalysts, especially palladium black.

Almost all organic compounds of the platinum group metals are combustible, and many can ignite spontaneously on exposure to air.

**Catalytic Decomposition.** Sufficiently concentrated hydrogen peroxide can decompose explosively on addition of PGM catalysts. The violence of this reaction decreases in the order Os > Pd > Pt > Ir > Au > Ag > base metals

Peroxides, ozonides, hydrazine, and concentrated peroxy acids such as peroxosulfuric acid explode even on contact with massive platinum.

Concentrated formic acid can also explode in the presence of noble-metal catalysts.

## 25.12 References

1. D. McDonald: *A History of Platinum*, J. Matthey Co., London 1960.
2. D. McDonald, L. B. Hunt: *A History of Platinum and its Allied Metals*, J. Matthey Co., London 1982.
3. *Platinum Metals Review*, vol. 1 (1957)–vol. 36 (1992), J. Matthey Co., London.
4. A. Binz: *Edelmetalle – Ihr Fluch und Segen*, W. Limpert-Verlag, Berlin 1943.
5. Fonds der Chemischen Industrie: "Edelmetalle Gewinnung, Verarbeitung, Anwendung", *Folienserie*, no. 12, Frankfurt 1989.
6. J. Falbe, M. Regitz (eds.): *Römpp Chemie Lexikon*, 9th ed., Thieme, Stuttgart 1989–1992.
7. H. Römpp: *Chemie der Metalle*, Franckh'sche Verlagshandlung, Stuttgart 1941.
8. P. Walden: *Chronologische Übersichtstabellen zur Geschichte der Chemie (Altertum bis 1950)*, Springer-Verlag, Berlin 1952.
9. S. Neufeld: *Chronologie Chemie 1800–1980*, VCH-Verlagsgesellschaft, Weinheim 1987.
10. H. Quiring: "Platinmetalle", *Die metallischen Rohstoffe*, vol 16, Enke Verlag, Stuttgart 1962.
11. J. Morin: *La platine, l'or blanc ou le huitième métal*, Paris 1758.
12. A. Galán, R. Moreno: "Platinum in Eighteenth Century – A Further Spanish Contribution to an Understanding of Its Discovery and early Metallurgy", *Platinum Met. Rev.* 36 (1992) 40–47.
13. D. McDonald: "One Hundred and Fifty Years – An Anniversary Review of Johnson Matthey's Role in the Economic History of Platinum", *Plat. Met. Rev.* 11 (1967) 18–29.
14. H. M. Severin: *Gold and Platinum Coinage of Imperial Russia from 1701–1911*, Crown and Taler Publ. Co., New York 1958.
15. H.-G. Bachmann, H. Renner: "Nineteenth Century Platinum Coins", *Platinum Met. Rev.* 28 (1984) 126–131.

16. A. L. von Erengreuth: *Allgemeine Münzkunde und Geldgeschichte des Mittelalters und der neueren Zeit*, R. Oldenbourg, München 1971.
17. L. B. Hunt: "Dr. Hans Merensky - Centenary of the Discoverer of the Platinum Reef", *Platinum Met. Rev.* 15 (1971) 102-107.
18. J. Levin: *The Story of Mintek 1934-1984*, Council for Mineral Technology (Mintek), Randburg 1985.
19. A. M. Edwards, M. H. Silk: *Platinum in South Africa*, Council for Mineral Technology (Mintek), Randburg 1987.
20. H. Houben: *Festschrift zum fünfzigjährigen Bestehen der Platinschmelze G. Siebert GmbH. Hanau, Alberti's Hofbuchhandlung, Hanau 1931*.
21. D. G. Cooper: *Das Periodensystem der Elemente*, Vlg. Chemie, Weinheim 1972.
22. E. Fluck, K. G. Heumann, *Periodensystem der Elemente*, IUPAC-Empfehlungen, VCH-Verlagsges., Weinheim 1985.
23. H. P. Münster, *Taschenbuch des Metallhandels*, 8th ed., Metallverlag, Berlin 1989.
24. G. H. Aylward, I. J. Findlay: *Datensammlung Chemie*, Verlag Chemie Weinheim 1975.
25. National Bureau of Standards Circulars.
26. R. W. Douglass, F. C. Holden, R. J. Jaffee: *High-Temperature Properties and Alloying Behavior of the Refractory Platinum-group Metals*, Battelle Memorial Institute, Columbus 1959.
27. E. M. Savitskii, V. P. Polyakova, M. A. Tylkina: *Palladium Alloys*, Primary Sources/Publ., New York 1968.
28. Doduco: *Datenbuch - Handbuch für Techniker und Kaufleute*, 2nd ed., Pforzheim 1977.
29. The Platinum Association: *Platinum, Production Properties and Applications, a Short Course*, Hill & Knowlton, Frankfurt 1989.
30. Ullmann, 4th ed., 18, 700 ff.
31. Kirk-Othmer, 3rd ed., 18, 230.
32. Degussa: *Platingeräte - Beständigkeit und Handhabung*, Hanau 1976.
33. R. Bock: *Aufschließmethoden der anorganischen und organischen Chemie*, Vlg. Chemie, Weinheim 1972.
34. Gmelin, 8th ed. System no. 68 (Platin), 65 (Palladium), 64 (Rhodium), 67 (Iridium), 63 (Ruthenium), 66 (Osmium).
35. F. Merian: *Metals and their Compounds in the Environment - Occurrence, Analysis, and Biological Relevance*, 2nd ed., VCH-Verlagsgesellschaft, Weinheim 1991.
36. E. Merian (ed.): *Metalle in der Umwelt*, Verlag Chemie, Weinheim 1984.
37. R. G. Schwab, "Was wissen wir über die tieferen Schichten der Erde?", *Angew. Chem.* 86 (1974) 612-624.
38. C. Bresch, *Zwischenstufe Leben*, Piper-Verlag, München 1977.
39. W. Schreiter: *Seltene Metalle*, vol. 2, Dtsch. Verlag f. Grundstoffind., Leipzig 1961.
40. H. Scheiderhöhn: *Erzlagertstätten*, Fischer Verlag, Stuttgart 1962.
41. V. Tafel: *Lehrbuch der Metallhüttenkunde*, vol. 1, Hirzel Vlg., Leipzig 1951.
42. A. Cissarz: "Verbreitung der Platinmetalle, ihre Lagerstättenkundliche Stellung und ihre Anteile an der Weltproduktion", *Erzmetall* 25 (1972) 7-16.
43. Gesellschaft Deutscher Metallhütten- und Bergleute (ed.): "Edelmetalle Exploration und Gewinnung", *Schriftreihe der GDMB*, no. 44, VCH-Verlagsgesellschaft, Weinheim 1986.
44. W. Gocht: *Handbuch der Metallmärkte-Erzvorkommen. Metallgewinnung, Metallverwendung, Preisbildung, Handelsregelungen*, 2nd ed., Springer-Verlag, Berlin 1985.
45. F. Pawlek, *Metallhüttenkunde*, Walter de Gruyter Verlag, Berlin 1983.
46. Winnacker-Küchler, 4th ed., 4, pp. 541-572.
47. R. L. Bates, J. A. Jackson (eds.): *Glossary of Geology*, 2nd ed., American Geological Institute, 1980.
48. J. R. Loebenstein: *Mineral Commodity Profiles, 1984*, Bureau of Mines, US Department of the Interior, Washington, annually.
49. V. I. Smirnov (ed.): *Ore Deposits of the USSR*, vol. II, Pitman Publishing, 1977.
50. C. B. Coetzee: *Mineral Resources of the Republic of South Africa*, Department of Mines, Pretoria 1976.
51. J. Lurie: *South African Geology for Mining, Metallurgical, Hydrological and Civil Engineering*, McGraw-Hill, Johannesburg 1981.
52. W. Herzberg: "Der Bergbau Südafrikas", *Metall* 37 (1984) 407-411.
53. R. C. Hochreiter, D. C. Kennedy, W. Muir, A. I. Woods: "Platinum in South Africa", *J. S. Afr. Inst. Min. & Metall.* 85 (1985) no. 6, 165.
54. A. M. Edwards, M. H. Silk: "Platinum in South Africa", *Mintek Special Publication*, no. 12, Randburg 1987.
55. H. Renner, U. Tröbs: "Rohstoffprofil Ruthenium", *Metall* 42 (1988) 714-716.
56. H. Renner, U. Tröbs: "Rohstoffprofil Osmium", *Metall* 44 (1990) 687-690.
57. H. Renner, U. Tröbs: "Rohstoffprofil Iridium", *Metall* 40 (1986) 726-730.
58. H. Renner, U. Tröbs: "Rohstoffprofil Rhodium", *Metall* 38 (1984) 1002-1005.
59. O. Stoppinski: *Platinum Group Metals*, National Research Council, Washington 1977.
60. Hargreaves, Williamson (eds.): *The Platinum Industry. Prospects in Recovery*, Shearson/American Express, London 1984.
61. L. B. Cabril: *Platinum-Group Elements*, The Canadian Institute of Mining and Metallurgy, Ottawa 1981.
62. "Metalle aus dem Meteoritenkrater-Nickel, Kupfer, und Platin in Sudbury", *Neue Zürcher Zeitung* 1990, no. 258, Nov. 7.
63. T. P. Mohide: *Platinum Group Metals - Ontario and the World*, Ministry of Natural Resources, Ontario 1979.
64. Mintek: "The Successful Development of an Industrial Process for the Recovery of Platinum-group Metals from the UG-2 Reef", *Application Report*, no. 1, Randburg, 1987.
65. Mintek: "Recovery of PGMs from the UG-2 Reef", *Research Digest*, no. 29, Randburg, 1988.
66. G. Hempel: "Wozu Polarforschung?", *Erzmetall* 37 (1984) 577-584.
67. H. Renner: *Behandlung und Verwertung von verbrauchten edelmetallhaltigen Katalysatoren. Müll- und Abfallbeseitigung (Müllhandbuch)*, 2nd ed., no. 8595, E. Schmidt-Verlag, Berlin 1987.
68. W. Hasenpusch: "Aufarbeitung von Autoabgaskatalysatoren - Die oberirdische Platin-Mine", *EFCE Publ. Ser.* 10 (1989) no. 79.
69. H. Giegerich, C. Hensel: "Autokat-Recycling - ein Beitrag zur künftigen Edelmetallversorgung", *Metall* 44 (1990) 684-687.
70. G. A. Jensen: "Platinum-group Metals as a Possible By-product of Nuclear Reactions", *Precious Met. Proc. Int. Precious Met. Inst. Conf., 9th Meeting*, Allentown, PA, 1985, 235-252.
71. G. Buckow et al.: *Verwertung von Reststoffen aus einer Wiederaufbereitungsanlage*, Gesellschaft für Reaktorsicherheit (GRS), Köln 1986.
- H. Röthemeyer: *Endlagerung radioaktiver Abfälle*, VCH-Verlagsges., Weinheim 1991.
72. R. Saager: *Metallische Rohstoffe von Antimon bis Zirkonium*, Bank Vontobel, Zürich 1984.
73. V. E. McKelvey, E. N. Cameron: *The Mineral Potential of United States 1975-2000*, University Wisconsin Press, Madison 1973.
74. D. Meadows, E. Zahn, P. Milling: *Die Grenzen des Wachstums*, 15th ed., Deutsche Verlagsanstalt, Stuttgart 1990.
75. L. Trueb: "Das Platin und seine fünf Geschwister einer Geschichte der Platinmetalle", *Neue Zürcher Zeitung* 1989, no. 298 (Dec. 21).
76. L. Trueb: "Platinmetalle - Vom Bergwerk zum Katalysator", *Neue Zürcher Zeitung* 1989 no. 194 (Jun. 14).
77. O. S. North: *Mineral Exploration, Mining and Processing Patents*, McGraw-Hill, New York, annually.
78. E. Henglein: *Lexikon Chemische Technik*, VCH-Verlagsgesellschaft, Weinheim 1988.
79. G. Agricola: *Vom Berg- und Hüttenwesen*, DTV-Verlag, München 1980.
80. W. Truthe: *Hundert Jahre Gold- und Silber-Scheidung nebst Gewinnung der Platinmetalle*, Degussa 1943, unpublished.
81. E. Jackson: *Hydrometallurgical Extraction and Reclamation*, Ellis Horwood, Chichester 1986.
82. E. M. Savitskii: *Handbook of Precious Metals*, Hemisphere Publishing Corp., New York 1989.
83. J. C. Mostert, P. N. Roberts: "Electric Smelting at Rustenburg Platinum Mines Ltd. of Nickel-Copper Concentrates containing Platinum Group Metals", *J. S. Afr. Inst. Min. Metall.* 73 (1973) no. 9, 290.
84. C. F. Brugman, D. G. Kerfoot, "Treatment of Nickel-Copper Matte at Western Platinum by the Sherritt Acid Leach Process", *International Nickel Conference*, Toronto, Canada, 1985.
85. Degussa: *Metall Forschung und Entwicklung im Degussa-Forschungszentrum Wolfgang*, Frankfurt 1991.
86. J. E. Hoffmann, *J. Met.* 40 (1988) no. 6, 40-44.
87. E. J. Kohlmeier, K. von Sprenger, *Z. Anorg. Chem.* 257 (1948) 199-214.
88. V. Jung, *J. Met.* 33 (1981) no. 10, 42-44.
89. Degussa, DE 2059235, 1970 (V. Jung).
90. V. Jung: "The Treatment of Automotive Exhaust Catalysts", *TMS/GDMB-Conference*, Productivity and Technology in the Metallurgical Industries, Köln, Sept. 1989.
91. D. Meredith et al., *Stahl + Eisen* 17 (1988) 796-800.
92. S. E. Stenkvist, *Steel Times*, 1985, no. 10, 480-483.
93. Iron and Steel Society, *Plasma Technology in Metallurgical Processing*, Grand Junction, CO/USA, 1987.
94. Degussa, DE 3223501, 1983 (H. Renner, K. Kleis, R. Schlodder).
95. W. C. Heræus GmbH, DE 2911193, 1979.
96. International Precious Metals Institute (ed.): *Current Publications and Proceedings of Conferences and Seminars*, Dave Schneller, Boulder 1979, pp. 92 ff.
97. F. A. Cotton, G. Wilkinson: *Advanced Inorganic Chemistry*, 4th ed., John Wiley & Sons, New York 1980, pp. 950-966.
98. F. A. Cotton, G. Wilkinson: *Anorganische Chemie*, Vlg. Chemie, Weinheim 1970.
99. G. Wilkinson, R. D. Gillard, J. A. McCleverty: *Comprehensive Coordination Chemistry*, vol. 5, Pergamon Press, Oxford 1987.
100. F. R. Hartley: *The Chemistry of Platinum and Palladium*, John Wiley & Sons, New York 1973.
101. S. E. Livingstone, in J. C. Bailar et al. (eds.): *Comprehensive Inorganic Chemistry*, vol. III, Pergamon Press, New York 1973, pp. 163-1370.
102. N. N. Greenwood, A. Earnshaw: *Chemie der Elemente*, VCH-Verlagsgesellschaft, Weinheim 1988.
103. S. Daamach, G. Cote, D. Bauer: "Separation of Platinum-group Metals in Hydrochloric media: Solvent Extraction of Palladium(II) with Dialkyl Sulfides", *IPMI* 1977, No. 22.
104. D. W. Agers, E. R. de Ment: "The Evaluation of New LX Reagents for the Extraction of Copper and Suggestions for the Design of Commercial Mixer-Settler Plants", *The Metallurgical Society of AIME*, Paper no. A 72-82, 1972.
105. Matthey Rustenburg Ref., GB 2013644, 1978/1979 (K. J. Shanton, R. A. Grant).
106. Matthey Rustenburg Ref, DE-OS 2459099, 1973/1975 (J. B. Payne).
107. L. Manziak (ed.): "Precious Metals Recovery and Refining", *Proceedings of the Precious Metals Recovery and Refining Seminar*, Nov. 12-14, 1989, Scottsdale, Arizona.
108. V. H. Apprahamian, G. P. Demopoulos, G. B. Harris: "The Behavior of Impurities during the Solvent Extraction of Platinum Metals with TN 1911 Extractants" in *Precious Metals 1991*, IPMI, Allentown, PA, 1991, p. 143.
109. W. Hasenpusch: "Die Trennung der Platinmetalle", *CLB, Chem. Labor Betr.* 38 (1987) 454.
110. Ch. Baes, R. E. Mesmer: *The Hydrolysis of Cations*, J. Wiley and Sons, New York 1976.
111. M. Knothe: "Untersuchungen zum Verhalten des Rh, Pd, Ir und Pt im Chloridmedium an Anionenaustauschern", *Z. Anorg. Allgem. Chem.* 463 (1980) 204-212.
112. A. P. Evers, R. J. Edwards, M. Fieberg, DE 2726558 B2, 1976/1981.
113. G. Schmucler, US 4885143, 1989.
114. W. Proding: *Organische Fällungsmittel in der quantitativen Analyse*, Enke Verlag, Stuttgart 1954.

115. J. Fries, H. Getrost, *Organische Reagentien für die Spurenanalyse*, E. Merck, Darmstadt 1977.
116. D. A. Boyd: *A Novel Approach to PCM Refining*, IPMI, 1992.
117. R. Marr, H.-J. Bart: "Metallsalz-Extraktion", *Chem.-Ing.-Tech.* **54** (1979) 119–129.
118. L. Alders: *Liquid-Liquid Extraction—Theory and Laboratory Practice*, Elsevier Publishing, Amsterdam 1959.
119. G. M. Ritcey, A. W. Ashbrook: *Solvent Extraction: Principles and Application to Process Metallurgy*, Elsevier, New York 1984.
120. F. Habashi: "Hydrometallurgy", *Principles of Extractive Metallurgy*, vol. 2, Gordon and Breach, New York 1970.
121. G. H. Morrison, H. Freiser: *Solvent Extraction in Analytical Chemistry*, J. Wiley & Sons, New York 1957.
122. E. J. Barnes, J. D. Edwards: "Solvent Extractions at Inco's Acton Precious Metal Refinery", *Chem. & Ind. (London)* **1982** no. 3, 151–164.
123. R. J. Edwards: "Refining of the Platinum-group Metals", *J. Met.* **28** (1976) no. 8, 49.
124. R. J. Edwards: "Selective Solvent Extractants for the Refining of Platinum Metals", *Proceedings of the International Solvent Extraction Conference ISEC 7*, Vol. 1, CIM, Special Vol. 21, 24 (1979).
125. D. S. Flett: "Solvent Extraction in Precious Metal Refining", *IMPT Seminar*, London 1982.
126. E. M. Elkin, P. W. Bennett: "A new Technique for the Recovery of Palladium and Platinum from Gold Electrolyte", *J. Met.* **17** (1965) no. 3, 252–254.
127. G. Brauer: *Handbuch der präparativen anorganischen Chemie*, vol. 3, Enke, Stuttgart 1980.
128. R. Gilchrist: "The Platinum Metals", *Chem. Rev.* **32** (1943) 277–372.
129. Matthey Rustenburg Ref., GB 2065092, 1980 (R. A. Grant).
130. Matthey Rustenburg Remers: "The Separation Chemistry of Rhodium and Iridium", *Proceedings of a Seminar of the International Precious Metals Institute*, IMPI, Scottsdale, AZ, 1989.
131. P. Charlesworth: "Separating the Platinum Group Metals by Liquid-Liquid Extraction", *Platinum Met. Rev.* **25** (1981) 106–112.
132. L. R. P. Reavill, P. Charlesworth: "The Application of Solvent Extraction to Platinum Group Metals Refining", *Proceedings of the International Solvent Extraction Conference*, ISEC '80 vol. 3, Liège 1980.
133. M. J. Clearne, P. Charlesworth, D. J. Bryson: "Solvent Extraction in Platinum Group Metal Processing", *J. Chem. Technol. Biotechnol.* **29** (1979) 210–214.
134. Matthey Rustenburg Ref., US 3979207, 1974 (J. J. McGregor).
135. INCO, US 4390366, 1983 (R. K. Lea, J. D. Edwards, D. F. Colton).
136. M. Fieberg, R. J. Edwards: "The Extraction of Gold from Chloride Solutions", *Rep. Natl. Inst. Metall. (S. Afr.)* **1978**, no. 1996.
137. A. S. Myerson, K. Toyokura (eds.): "Crystallisation as a Separations Process", *ACS Symp. Ser.* **438** (1990).
138. W. Gösele et al.: "Feststoffbildung durch Kristallisation und Fällung", *Chem.-Ing.-Tech.* **62** (1990) 544–552.
139. W. Hasenpusch, K. Bonin: "Kristallisation von Ammonium-Hexachloroplatinat(IV)", *Chem.-Ztg.* **1991**, no. 5, 129–133.
140. R. B. Wilson, W. D. Jacobs: "Separation of Iridium from Rhodium by Extraction with Tributyl Phosphate", *Anal. Chem.* **33** (1961) 1650–1652.
141. S. J. Tanaka: "The Recovery and Purification of Rhodium using Superlig™ Technology from a Platinum-group Metals Stream", IPMI 1992.
142. Matthey Rustenburg Ref., US 4382067, 1982/1983 (R. A. Grant).
143. Matthey Rustenburg Ref., DE-OS 2457672, GB 5682673, 1973/1979 (J. J. McGregor).
144. PGM Industries, DE-OS 2726390, 1977/1979 (J. Baltz, E. Coltrinari).
145. National Institute for Metallurgy (NIM), GB 1490815, 1974/1977 (R. J. Edwards).
146. AT & T Technologies, US 4479922, 1983 (R. Haynes, A. Jackson).
147. H. Renner: "The Selective Solvent Extraction of Palladium by the Use of Di-Normal-Hexylsulfide", *Rep.-MINTÉK*, 1985, no. 217.
148. G. P. Demopoulos: "Solvent Extraction in Precious Metals Refining", *J. Met.* **1986** no. 6, 13–17.
149. G. P. Demopoulos: "A Radically New Solvent Extraction Process for Rhodium Recovery", in *Precious Metals 1992*, IPMI, 1992.
150. M. Grote, U. Hüppe, A. Kettrop: "Solvent Extraction of Noble Metals by Formazons(II)", *Hydrometallurgy* **19** (1987) 51–68.
151. K.-H. König: "Zur Solventextraktion von Platinmetallen", *Achema*, Frankfurt 1985.
152. M. Knothe: "Die Fällung des Pd<sup>II</sup> als Pd(NH<sub>3</sub>)<sub>2</sub>Cl<sub>2</sub> sowie des Verhaltens verschiedener Begleitelemente", *Z. Anorg. Allg. Chem.* **503** (1983) 213–223.
153. A. P. Evers, R. J. Edwards, M. M. Fieberg, SA 763681, 1976.
154. R. F. Edwards, M. M. Fieberg, W. te Riele, B. C. Want, US 4155750, 1979.
155. A. Prior, K. H. Ohrbach, A. Ketrup, G. Matuschek: "Calcination of Platinum Group Metal Complexes to Form Pure Metals", *IPMI Seminar*, 1988.
156. A. Prior, B. Lerwill: "Cost Management Strategies in Refineries in the 1990s", *IPMI Seminar*, Tempe, AZ, 1991.
157. V. S. Khain, E. V. Fomina: "Reduction of OsO<sub>4</sub> by Sodium Tetrahydroborate in Acidic Medium", *Russ. J. Inorg. Chem. (Engl. Transl.)* **25** (1980) 307–308.
158. Degussa: *Edelmetall-Taschenbuch*, Frankfurt 1967.
159. E. M. Wise: *Palladium*, Academic Press, New York 1968.
160. J. A. Federov: *Rhodium*, Nauka Vlg., Moskau 1966.
161. J. C. Chaston: "The Purity of Platinum", *Platinum Met. Rev.* **15** (1971) 122–128.
162. A. Wogrinz: *Analytische Chemie der Edelmetalle*, Enke Verlag, Stuttgart 1936.
163. F. Ensslin: *Edelmetall-Analyse*, Springer-Verlag, Berlin 1964.
164. Chemikerausschuß der GDMB (ed.): *Analyse der Metalle*, 2nd ed., Springer-Verlag, Berlin 1961.
165. F. E. Beamish, J. C. van Loon: *Analysis of Noble Metals*, Academic Press, New York 1977.

166. S. Kallmann: "A Survey of the Determination of the Platinum Group Elements", *Talanta* **34** (1987) no. 8, 677–698.
167. H. G. Sigel, A. Sigel (eds.): *Handbook on Toxicity of Inorganic Compounds*, Marcel Dekker, New York 1988.
168. E. D. Goldberg et al.: "Determination of Platinum Sediments", *Anal. Chem.* **58** (1986) 616–620.
169. H.-M. Lüschoy: "Probenahme, Theorie und Praxis", *Schriftenreihe der GDMB*, Verlag Chemie, Weinheim 1980.
170. H.-M. Lüschoy: "Zur Probenahme von Edelmetallen, Teil 1: Probenahme von metallischen Materialien", *Erzmetall* **42** (1989) 153–159.
171. H.-G. Bachmann, E. Koberstein, R. Straub: *Chemie-Technik 7* (1978) 441–446.
172. J. Suchomel, Fresenius' *Z. Anal. Chem.* **300** (1980) 257–266; Fresenius' *Z. Anal. Chem.* **307** (1981) 14–18.
173. B. Welz: *Atomic Absorption Spectrometry*, VCH-Verlagsgesellschaft, Weinheim 1985.
174. G. Jäger: *Über die Platinbestimmung in Platinierung-Katalysatoren*, Dissertation, Mainz 1957.
175. W. Diehl: "Die quantitative Bestimmung der Verunreinigungen der Ag, Au, Pt und Rh mit einem 3,4-m-Gitterspektrographen", *Metall (Berlin)* **23** (1969) 587–589.
176. F. Mylius: "Reinheitsgrade von Metallen des Handels", *Z. Anorg. Chem.* **74** (1912) 407.
177. F. Mylius, A. Mazzuchelli: "Über die Platinanalyse", *Z. Anorg. Allg. Chem.* **89** (1914) 1–38.
178. DIN 43760, 1968.
179. DIN 43710, 1977.
180. *Gmelin*, Platin, suppl. vol. A1, 8.
181. H. Wolf: "Die Edelmetalle in Forschung und Industrie", *Metall* **12** (1958) no. 7, 3–16.
182. J. Sagoschen: "Platin-Laborgeräte", *Chem. Ztg.* **88** (1964) 420–429.
183. G. Reinacher: "Platin-Geräte im Labor", *Chem. Anlagen + Verfahren* **1970**, no. 1/2, 61–63.
184. Degussa: *Platin-Geräte für Labor und Praxis*, no. 1 ff., Frankfurt 1977 ff.
185. G. Reinacher: "Über die Gewichtskonstanz von Geräten aus der Legierung Platin/3% Iridium bei analytischen Operationen", *Werkst. Korros.* **1964**, no. 1, 84–88.
186. G. Reinacher, H. Roters: "Neuere Anwendungen von Platinwerkstoffen in Chemie und Glasindustrie", *Metall* **23** (1969), 570–575.
187. G. Reinacher: "Anwendung von Platin-Werkstoffen in Glashütten", *Chem. Anlagen + Verfahren* **1975**, no. 10, 27–34.
188. D. Böttger: "The Use of Platinum in the Glass Industry", *Glass* **62** (1985) no. 5, 177–178; *Metall* **39** (1985) 748–750.
189. M. Rowe: "Noble Metals in the Glass Industry", *Ceram. Eng. Sci. Proc.* **6** (1985) 256–268.
190. W. Funk, R. Schumm: "Spinnndüsen – Bauteile für die Chemiefaserindustrie", *Chemiefasern + Text. Anwendungstech./Text.-Ind.* **22** (1972) 518–521.
191. J. R. Anderson, M. Baudart: *Catalysis, Science and Technology*, vols. 12, Springer-Verlag, Berlin 1981.
192. Fonds der Chemischen Industrie: "Katalyse", *Fo-lienserie*, no. 19, Frankfurt 1986.
193. K. Weissmerl, H. J. Arpe: *Industrial Organic Chemistry*, Verlag Chemie, Weinheim 1978.
194. P. N. Rylander: *Catalysis Hydrogenation over Platinum Metals*, Academic Press, New York, 1967.
195. W. Hölderich, M. Scheerzmann, W. D. Mross: "Heterogene Katalysatoren in der chemischen Industrie", *Erzmetall* **39** (1986) 292–298.
196. A. J. Bird, A. B. Stiles: *Catalyst Supports and Supported Catalysts*, Butterworth, London 1987.
197. J. Falbe, U. Haserodt: *Katalysatoren, Tenside und Mineralöladditive*, Thieme Verlag, Stuttgart 1978.
198. D. M. Little: *Catalytic Reforming*, Pennwall Pub., Tulsa 1985.
199. W. Ostwald, E. Brauer, in H. Huben (ed.): *Festschrift zum fünfzigjährigen Bestehen der Platin-schmelze G. Siebert GmbH*, Hanau, Hanau 1931, pp. 240–256.
200. H. Holzmann: "Über die katalytische Oxidation von Ammoniak bei der industriellen Salpetersäure-Herstellung", *Chem.-Ing.-Tech.* **39** (1967) 89–95.
201. F. Sperner, W. Hohmann: "Rhodium-Platinum Gauzes für Ammonia Oxidation", *Platinum Met. Rev.* **20** (1976) 12–20.
202. H. Connor: "The Role of Platinum Alloys Gauzes in the Ammonia Oxidation Process", *Platinum Met. Rev.* **11** (1967) 2–9, 60–69.
203. E. G. Schlosser: "Die Katalysator-Desaktivierung und -Vergiftung in verfahrenstechnischer Sicht", *Chem.-Ing.-Tech.* **47** (1975) 997–1005.
204. R. Ugo: "Aspects of Homogeneous Catalysis", D. Reibel Publ., Dordrecht 1970.
205. F. J. Smith: "New Technology for Industrial Hydroformulation", *Platinum Met. Rev.* **19** (1975) 93–95.
206. K.-H. Schmidt: "Neuentwicklungen in der homogenen Katalyse", *Chem. Ind.* **37** (1985) 762–765.
207. J. Osborn, G. Wilkinson, *Chem. Commun.* **1965**, 131.
208. H. Brunner: "Rhodium-Katalysatoren für die enantioselektive Hydroxylierung – ein neues Konzept zur Entwicklung asymmetrischer Katalysatoren", *Angew. Chem.* **95** (1985) 921–931.
209. G. J. K. Acres, B. J. Cooper: "Automobil Emission Control Systems", *Platinum Met. Rev.* **16** (1972) 74–86.
210. W. Weigert, E. Koberstein, E. Lakatos: "Katalysatoren zur Reinigung von Autoabgasen", *Chem.-Ztg.* **97** (1973) 469–478.
211. O. Stopinski: *Platinum-group Metals*, National Research Council, Washington 1977.
212. E. Koberstein: "Katalysatoren zur Reinigung von Autoabgasen", *Chemie in unserer Zeit* **18** (1984) no. 2, 37–45.
213. A. Keil: *Werkstoffe für elektrische Kontakte*, Springer, Berlin 1960.
214. A. von Krusenstjern: *Edelmetall-Galvanotechnik*, Leuze-Vlg., Saalgau 1970.
215. D. Schlain et al.: "Electrodisposition of Platinum Metals from Molten Cyanides", *Platinum Met. Rev.* **21** (1977) 38–42.
216. J. H. Notton: "Fused Salt Platinum Plating for Industrial Applications", *Platinum Met. Rev.* **21** (1977) 122–128.
217. H.-H. Beyer, F. Simon, *Metall* **34** (1980) 1016–1018.



# 26 Tungsten

ERIK LASSNER, WOLF-DIETER SCHUBERT (§§ 26.1, 26.2.2, 26.3–26.11); HANS UWE WOLF (§ 26.12)

26.1 Introduction .....	1329	26.5 Uses .....	1345
26.2 Properties .....	1330	26.6 Analysis .....	1347
26.2.1 Physical Properties .....	1330	26.6.1 Raw Materials .....	1347
26.2.2 Chemical Properties .....	1332	26.6.2 High-Purity Intermediate Products, Tungsten Powder, and Compact Tungsten Metal .....	1347
26.3 Raw Materials .....	1333	26.6.3 Trace Elements in High-Purity Tungsten Metal .....	1348
26.3.1 Natural Resources .....	1333	26.7 Compounds and Intermetallic Compounds .....	1348
26.3.2 Tungsten Scrap .....	1335	26.7.1 Tungsten Chemistry .....	1348
26.4 Production .....	1335	26.7.2 Tungsten–Boron Compounds .....	1349
26.4.1 Ore Beneficiation .....	1335	26.7.3 Tungsten–Carbon Compounds .....	1349
26.4.2 Pretreatment of Ore Concentrates and Scrap .....	1336	26.7.4 Tungsten–Silicon Compounds .....	1349
26.4.3 Hydrometallurgy .....	1336	26.7.5 Tungsten–Nitrogen Compounds .....	1349
26.4.3.1 Digestion .....	1336	26.7.6 Tungsten–Phosphorus Compounds .....	1350
26.4.3.2 Purification .....	1337	26.7.7 Tungsten–Arsenic Compounds .....	1350
26.4.3.3 Conversion of Sodium Tungstate Solution to Ammonium Tungstate Solution .....	1339	26.7.8 Tungsten–Oxygen Compounds .....	1350
26.4.3.4 Crystallization of Ammonium Paratungstate (APT) .....	1340	26.7.9 Tungsten–Chalcogenide Compounds .....	1352
26.4.4 Calcination of Ammonium Paratungstate .....	1340	26.7.10 Tungsten–Halogenide Compounds .....	1352
26.4.5 Reduction by Hydrogen to Tungsten Metal Powder .....	1340	26.8 Tungsten in Catalysis .....	1353
26.4.6 Production of Compact Metal .....	1342	26.9 Economic Aspects .....	1353
26.4.7 Processing of Sintered Parts .....	1342	26.10 Tungsten Recycling .....	1355
26.4.7.1 Shaping .....	1342	26.11 Beneficial Effects on Human Health .....	1356
26.4.7.2 Mechanical Bonding of Tungsten to Tungsten and Other Metals .....	1343	26.12 Toxicology and Occupational Health .....	1356
26.4.8 Surface Treatment .....	1344	26.13 References .....	1358
26.4.9 Tungsten Coatings .....	1344		
26.4.10 Production of High-Purity Tungsten Metal (99.999–99.9999%) .....	1345		

## 26.1 Introduction

Tungsten (wolfram, W), is a transition metal in the third long period and group 6 of the periodic table. Its electron configuration is  $[\text{Xe}] 6s^2 4f^{14} 5d^4$  but can also be interpreted as  $[\text{Xe}] 6s^1 4f^{14} 5d^5$ . The naturally occurring isotopes (abundances in parentheses) have relative atomic mass 180 (0.14%), 182 (26.42%), 183 (14.40%), 184 (30.64%), and 186 (28.41%). There are also 17 known artificial isotopes and isomers from  $^{137}\text{W}$  to  $^{189}\text{W}$ , with half-lives between 14  $\mu\text{s}$  and 140 d. In nature, tungsten occurs only in a chemically com-

bined state (mainly as tungstate). The metal, which has a silvery white luster, has a very high density (19.3 g/cm<sup>3</sup> at 20 °C), and the highest melting point (3410 °C) of all the metallic elements.

**History.** Long before elemental tungsten was discovered (1783), the mineral wolframite was known, e.g., in the tin mines of Saxony and Bohemia. It was first described in 1574 by LAZARUS ERCKER, and thought to be a tin mineral that contained arsenic and iron.

The name wolfram is derived from the word wolf, i.e., the wolf that devoured tin. A foam (Latin: *lupi spuma*, wolf's foam) was

formed on the molten tin during the smelting of tin ore, reducing the yield of tin.

In 1757, a new mineral with density 6 (scheelite) was described by A. F. CRONSTEDT. He named this "tungsten" (Swedish: *tung sten*, heavy stone) and considered it to be a calcium-containing iron mineral. In 1781, C. W. SCHEELE analyzed the ore and announced that it contained calcium with a hitherto unknown acid. He described digesting the mineral with  $K_2CO_3$ , precipitating the unknown acid with nitric acid, decomposing the mineral with mineral acids, and dissolving the precipitated acid in ammonia. In the same year, T. BERGMAN suggested that the metal might be obtained by reduction of the acid with carbon.

In 1783, the element was produced by the brothers J. J. and F. DE ELHUYAR from wolframite by reduction of the oxide with carbon. They named it wolfram. In 1786, the hardening of steel was described by H. I. DU MONCEAU. In 1821, K. C. VON LEONHARD proposed the name scheelite for the mineral  $CaWO_4$ .

The real chemistry of tungsten originated with R. OXLAND (1874), who patented a method for producing sodium tungstate, tungsten oxide, and metallic tungsten. He was also the first to propose a method for the production of ferrotungsten. The possibility of using tungsten as an alloying element to increase the hardness of steel could not initially be realized because of the high price of the metal.

The developments that led to the industrial use of tungsten began in 1890 with the production of WC by H. MOISSAN. They may be summarized as follows:

- In 1900, the Bethlehem Steel Company announced the first high-speed, high-temperature steel at the Paris Exhibition.
- In 1903, the first tungsten filaments for incandescent lamps were produced in Hungary by the method patented by JUST and HANAMANN.
- In his patent of 1909, W. D. COOLIDGE described the production of ductile tungsten wire by powder metallurgy, a process that has not changed in its essential features even

today. This process represents the first industrial use of powder metallurgy.

- In 1922, the Osram Research Association obtained a patent for the production of tungsten carbide-cobalt hard metals.
- Four years later, the Krupp organization introduced the first hard metal cutting tool at the Leipzig Exhibition.

The increasing use of hard metals in the machining of steel and in the mining industry (energy production) led to a great increase in the demand for tungsten. As a result of the uncertain availability of raw materials in crisis situations and the increased use of tungsten materials in the armaments industry (hard metals, tungsten-containing heavy metals), the metal has become of strategic importance.

All later materials developments are essentially only a broadening and diversification of the early work on the production of the metal and its alloys. Tungsten compounds are becoming increasingly important, e.g., as the active components in catalysts.

Continuously increasing demand up to the 1980s led to the constant exploration of tungsten deposits and the opening of mines and processing plants. However, owing to a fall in price and demand, a large number of mines have been closed since 1985, especially in the industrialized countries.

In terms of quantity, tungsten is the second most important high-melting metal, after molybdenum; however, it is the most important refractory metal used in powder metallurgy.

General information on tungsten and its alloys and compounds can be found in [1-7]. A summary of the early history can be found in [8].

## 26.2 Properties

### 26.2.1 Physical Properties

Tungsten has the highest melting point of all metals, exceeded only by elemental carbon and the metallic monocarbides of niobium, zirconium, tantalum, and hafnium. The extremely high bonding energy (due to the half-

filled  $5d$  shell) leads to extreme values of other properties. For example, tungsten has the lowest vapor pressure of all metals, the lowest compressibility, an extremely high density, a high modulus of elasticity, low thermal expansion, and high thermal conductivity.

Some physical properties of tungsten follow [1, 3, 9]:

Lattice type	A2, bcc
Lattice parameter	0.31648 nm
Atomic radius	0.139 nm
Ionic radius (4-valent)	0.064 nm
(6-valent)	0.068
Absorption cross section for thermal neutrons	19.2 barn
1st ionization potential	8.0 eV
$mp$	3410 °C
$bp$	5900 °C
Heat of fusion	35.17 kJ/mol
Heat of sublimation	850.8 kJ/mol
Molar heat capacity at 20 °C	24.28 Jmol <sup>-1</sup> K <sup>-1</sup>
Specific heat capacity at 25 °C	0.135 kJkg <sup>-1</sup> K <sup>-1</sup>
at 1000 °C	0.17
at 2000 °C	0.20
Coefficient of thermal expansion	
at 500 °C	2.3 mm/m
at 1500 °C	7.6
at 3000 °C	19.2
Thermal conductivity at 0 °C	129.5 Wm <sup>-1</sup> K <sup>-1</sup>
at 1000 °C	112.5
at 2000 °C	96.0
Vapor pressure at 1700 °C	1 × 10 <sup>-10</sup> Pa
at 2300 °C	4 × 10 <sup>-1</sup>
at 3000 °C	2 × 10 <sup>-3</sup>
Standard entropy $S_{25}^0$ at 101 kPa	32.76 Jmol <sup>-1</sup> K <sup>-1</sup>
Standard enthalpy $H_{25-273}^0$ °C	5.09 × 103 J/mol
Specific electrical resistivity	
at 20 °C	0.055 μΩm
at 1000 °C	0.330
at 2000 °C	0.655
at 3000 °C	1.40
Magnetic susceptibility at 25 °C	0.32 × 10 <sup>-6</sup> cm <sup>3</sup> /g
Black body temperature at 727 °C ( $\lambda = 665$ nm)	693 °C
Spectral emission at 25 °C ( $\lambda = 665$ nm)	0.47
Total radiation at 527 °C	0.173
at 1127 °C	3.82
at 2327 °C	80.60
Electron emission at 727 °C	1.07 × 10 <sup>-15</sup> A/cm <sup>3</sup>
at 1627 °C	2.28 × 10 <sup>-4</sup>
at 2227 °C	2.98 × 10 <sup>-1</sup>
Electron yield at 727 °C	1.77 × 10 <sup>-5</sup> A/W
at 1627 °C	1.22 × 10 <sup>-5</sup>
at 2227 °C	4.26 × 10 <sup>-5</sup>
Density at 20 °C	19.3 g/cm <sup>3</sup>
Hardness (Vickers) HV 30 at 0 °C	450
recrystallized	300
deformed	≤ 650
at 400 °C	240
at 800 °C	190
Modulus of elasticity at 0 °C	407 kN/mm <sup>2</sup>

at 1000 °C	365
at 2000 °C	285
Velocity of sound	
longitudinal	5320 m/s
transverse	2840
Minimum compression strength (sintered)	1150 N/mm <sup>2</sup>
Shear modulus at 20 °C	177 kN/mm <sup>2</sup>

### Mechanical and Metallurgical Properties.

Pure metallic tungsten has a body-centered cubic structure, is brittle at room temperature, and is therefore not suitable for cold forming. At elevated temperatures (ca. 100–500 °C) it is transformed into the ductile state. The temperature of this sharply defined transformation is mainly dependent on the purity and the history of deformation and heat treatment of the material. The transformation temperature is increased by the presence of extremely small amounts of interstitially soluble elements, e.g., oxygen, carbon, and nitrogen, which lead to intergranular precipitation. The transformation temperature decreases with increasing deformation; highly deformed products such as thin sheet and wire are ductile at room temperature. This is mainly due to the distribution of the precipitated impurities over a larger intergranular area, and the formation of a fine-grained fibrous structure which tends to prevent intergranular failure perpendicular to the fiber direction. In the fiber direction, the tendency toward intergranular failure is more or less constant.

Addition of rhenium can cause the transformation temperature to fall below room temperature, even for only slightly deformed products. With extremely pure single crystals, brittle-ductile transformation temperatures as low as -190 °C are observed.

The grain size and grain structure have a great influence on the mechanical properties of tungsten. These can be controlled by sintering conditions, type of deformation, degree of deformation, and annealing processes during and after machining (intermediate annealing, stress-relieving annealing, soft annealing, recrystallization annealing).

Consequences of the high bonding energy of tungsten include its high ultimate strength



and yield strength, high modulus of elasticity, and high recrystallization temperature.

The hot strength of tungsten, like its elongation, depends on its deformation and annealed condition, and can vary widely at a given temperature (Figure 26.1). The hot strength of tungsten is exceeded only by that of rhenium. The upper limit for the hot tensile strength corresponds to a stress-relieved sheet, and the lower limit to a recrystallized sheet. At ca. 1500 °C, both limiting curves coincide, i.e., at this temperature the tungsten completely recrystallizes as it is heated to the tensile testing temperature (and therefore at temperatures above this) independently of the starting condition of the tungsten, so that it always has the hot strength of recrystallized tungsten. The results of hot tensile testing are to some extent influenced by the strain rate.

The relation between temperature and fracture strain of recrystallized tungsten sheets is shown in Figure 26.2.

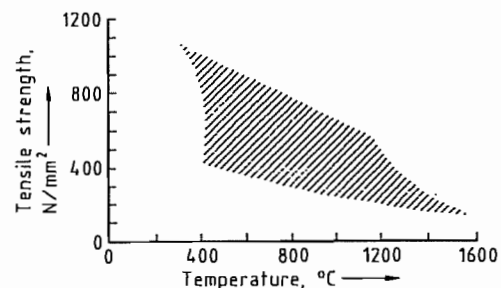

Figure 26.1: Hot tensile strength of tungsten sheet, thickness 1 mm, strain rate 15% min<sup>-1</sup> [3].

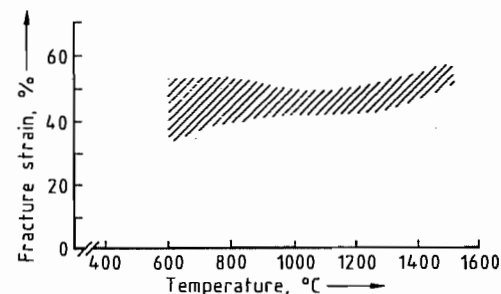

Figure 26.2: Effect of temperature on fracture strain of recrystallized tungsten sheet [3].

No allotropic transformations of group 6 metals are known which could lead to changes

in their properties. The solubility of the non-metals carbon, silicon, oxygen, nitrogen, and water in these metals is very small. Therefore, impurities in the form of interstitially dissolved nonmetals have a smaller effect on the mechanical properties than is the case with other transition metals, but have a very significant effect if the solubility limits are exceeded. Carbides, silicides, nitrides, and oxides are then formed [9], and the inclusions have a marked effect on grain shape and size.

As the solubility of interstitial impurities (O, N, C) at room temperature is well below 0.1 µg/g, and the solubilities, even at the eutectic temperature, are only 0.01–0.1% [10], the insoluble excess segregates at the grain boundaries on cooling. Oxide impurities, in particular, considerably reduce intergranular strength. With carbide impurities, a beneficial effect on ductility is apparent, depending on the form of the carbides. The effect of nitrides is not yet fully understood. In deformed tungsten, it leads to marked anisotropy of the mechanical properties in the direction of deformation, so that sheet and bar tend to split. In recrystallized tungsten, the intergranular impurities enable plastic deformation to take place above the transformation temperature, as already mentioned [9].

## 26.2.2 Chemical Properties

Tungsten is stable in air up to 350 °C, but begins to oxidize above 400 °C. A thin film of blue tungsten oxides forms on the surface, and this at first prevents further attack. As the temperature increases, cracks develop in the oxide film, and these favor oxidative attack. Above 800 °C, rapid oxidation takes place with formation of WO<sub>3</sub>, which sublimates. In oxygen, tungsten burns at 500–600 °C. Tungsten is stable to mineral acids in the cold, and is only slightly attacked at higher temperatures. Its stability to cold and hot hydrofluoric acid is of practical importance. Mixtures of hydrofluoric and nitric acids dissolve tungsten very readily, the tungsten remaining in solution because of the complexing effect of the fluoride ions. Hydrogen peroxide is a good solvent for finely

divided tungsten; the peroxo complexes so formed keep the tungsten in solution. Alkaline solutions do not attack tungsten, which is also very stable to molten alkalis. In the presence of oxidizing agents (Na<sub>2</sub>O<sub>2</sub>, NaNO<sub>2</sub>, or NaNO<sub>3</sub>), rapid dissolution takes place.

Tungsten is stable to molten glass and silica up to 1400 °C. At higher temperatures, it reacts with many elements, e.g., B, C, Si, P, As, S, Se, Te, and the halogens. It reacts with fluorine at lower temperatures. It is stable to chlorine up to 250 °C, and to bromine and iodine up to 500 °C. It is very stable to gaseous nitrogen and ammonia up to 1400 °C. There is no reaction with hydrogen. With carbon monoxide, the hexacarbonyl is formed at low temperatures, and the carbide above 800 °C.

## 26.3 Raw Materials

### 26.3.1 Natural Resources

The average concentration of tungsten in the earth's crust is 1.5 g/t. It is thus a rare element.

**Minerals.** Tungsten occurs only in combined form. The most important tungsten minerals are [4]:

Anthoinite	Al(WO <sub>3</sub> )(OH)·H <sub>2</sub> O
Cuprotungstite	Cu <sub>2</sub> (WO <sub>4</sub> )(OH) <sub>2</sub>
Ferritungstite	Ca <sub>2</sub> Fe <sup>2+</sup> Fe <sup>3+</sup> (WO <sub>4</sub> ) <sub>7</sub> ·9H <sub>2</sub> O
Raspite	PbWO <sub>4</sub>
Russellite	Bi <sub>2</sub> WO <sub>6</sub>
Sanmartinite	ZnWO <sub>4</sub>
Scheelite	CaWO <sub>4</sub>
Stolzite	PbWO <sub>4</sub>
Tungstenite	WS <sub>2</sub>
Tungstite	WO <sub>3</sub> ·H <sub>2</sub> O
Ferberite	FeWO <sub>4</sub> with up to 20% MnWO <sub>4</sub>
Hübnerite	MnWO <sub>4</sub> with up to 20% FeWO <sub>4</sub>
Wolframite	(Fe, Mn)WO <sub>4</sub>

With the exception of tungstenite, all the minerals are tungstates, but only scheelite and the wolframite group are of industrial importance. The most important properties of scheelite and the wolframites are listed in Table 26.1 [4].

Scheelite is often associated with the isomorphous calcium molybdate (powellite).

Pure scheelite has a blue fluorescence in ultraviolet light, becoming white with a molybdenum content of ca. 1%, and yellow above this concentration. This property is utilized in prospecting for scheelite.

Wolframite is a general term for a mixed crystal series (with no miscibility gap) of Fe(II) and Mn(II) tungstates. The minerals between pure iron tungstate and 20% MnWO<sub>4</sub> are known as ferberite. Manganese tungstate and mixed crystals containing up to 20% FeWO<sub>4</sub> are known as hübnerite.

The minerals tungstite and cuprotungstite have achieved a small degree of industrial importance.

**Deposits.** All tungsten deposits are of magmatic-hydrothermal origin. During cooling of the magma, differential crystallization occurs, first of basic and later of slightly acidic rocks, and enrichment of tungstate and other ions takes place, accompanied by an increase in the concentration of silica in the remaining magma and the hydrothermal solution. Tungsten cannot replace the main elements such as Fe, Mg, Ca, Al, and Si in the basic and slightly acidic rocks, and is not incorporated in the first material to crystallize. Therefore, scheelite and wolframite are often to be found in the last crystallization stage of a magma, i.e., the pegmatites and the material crystallized from hydrothermal solutions.

There are many types of deposit:

- Pegmatite deposits are relatively rare and can contain wolframite and scheelite. The tungsten minerals are crystallized together with the pegmatitic minerals.
- Greisen deposits contain wolframite, and are formed by the mineralization of intrusive rock (and of the rock it penetrates) by hydrothermal solution processes.
- Contact-metasomatic deposits are the commonest type and are of pure scheelite. They are formed by the reaction between limestone and residual magma or hydrothermal solutions that penetrate into it.

Table 26.1: Physical and chemical properties of ferberite, wolframite, hübnerite, and scheelite.

	Ferberite	Wolframite	Hübnerite	Scheelite
Formula	FeWO <sub>4</sub>	(Fe, Mn)WO <sub>4</sub>	MnWO <sub>4</sub>	CaWO <sub>4</sub>
WO <sub>3</sub> content, %	76.3	76.5	76.6	80.6
Crystal structure	monoclinic	monoclinic	monoclinic	tetragonal
Lattice parameters				0.5257
a, nm	0.471	0.479	a 0.485	1.1373
b, nm	0.570	0.574	c 0.577	a/c 1:2.165
c, nm	0.574	0.499	a/c 0.498	
β	90°	90°26'	90°53'	
Density, g/cm <sup>3</sup>	7.5	7.1–7.5	7.2–7.3	5.4–6.1
Color	black	dark gray–black	red-brown–black	brown, yellowish, white
Hardness (Mohs)	5	5–5.5	5	4.5–5
Common form	well-formed crystals or crystal masses	irregular crystal masses or radiating crystal groups	radiating groups or lamellar crystals	crystals, mainly fine grained

- Vein deposits can contain wolframite and scheelite. Hot magma causes cracks and faults in the surrounding rock, into which hydrothermal solution is injected. It then crystallizes.
  - Pneumatolytic deposits are rare, and are formed by the transport of volatile tungsten compounds in the gas phase.
  - Secondary enriched deposits are very rare and contain tungstite formed by weathering of wolframite.
  - Placer deposits, in which high density materials become concentrated in river sediments, are also very rare.
- The gangue minerals differ not only among the various deposits, but can also vary greatly within a single mine. This is easily understood, as the various types of deposits can often occur together in one mine. The commonest types of gangue minerals are: quartzite, various silicates, limestone, magnesite, fluorspar, apatite, and various sulfide ores.
- The concentration of workable ores is 0.1–2.5% WO<sub>3</sub>, contents of ca. 2% being rare. The average content is ca. 0.5% WO<sub>3</sub>. The lower limit of workability depends on the ore type, gangue composition, and world market price. It fluctuates between 0.1 and 0.3% WO<sub>3</sub>.
- Reserves.** Tungsten deposits occur throughout the younger mountain ranges, e.g., the Alps, the Himalayas, and the circum-Pacific belt. The most recent figures for world tungsten re-

serves (in 10<sup>3</sup> t) date from 1985, and are listed here [11]:

North America	985
United States	290
Canada	670
Mexico	20
Others	5
South America	110
Bolivia	70
Brazil	20
Others	20
Europe	665
Austria	20
France	20
Portugal	40
Former Soviet Union	490
United Kingdom	70
Others	25
Africa	20
Rwanda	5
Zimbabwe	5
Others	10
Asia	1535
Burma	15
China	1230
North Korea	100
South Korea	60
Malaysia	20
Thailand	30
Turkey	70
Others	10
Oceania	10
Australia	140

These figures include reserves that are known, but have so far not been found to be economically workable. This type of information is partly based on estimates, as countries such as China and the former Soviet countries have not published any accurate information. By far the largest reserves are in China (35%, but may exceed 50%), followed by Canada (19%), and the former Soviet Union (14%). At the current world annual consumption rate

of 30 000 t, these known reserves of ore are likely to last for ca. 120 years. Of the ore deposits, 75% are of scheelite and 25% wolframite, with a few in which both minerals occur together [12]. Over half the reserves of ore are in developing countries.

### 26.3.2 Tungsten Scrap

Tungsten scrap has been used as a raw material for production of pure tungsten for more than 50 years. There are several reasons for this:

- The low concentration in the earth's crust results in a consistently high cost of the metal; recycling has always been economic.
- The concentration of tungsten in the various types of scrap is always considerably higher (30–99%) than in any ore, so there are no concentration costs.
- The accompanying elements in scrap do not cause serious problems during chemical processing.

High demand and consequent high prices from 1975 to 1985 led to an increase in scrap processing, and made lower-grade scrap (grinding wheel swarf and dusts) more attractive for reuse [13]. Since then, the amount of scrap used as a percentage of the total tungsten raw materials has increased still further in spite of falling price and demand. This is largely because environmental regulations have become increasingly strict, making it impossible to dispose of scrap with even a low tungsten content, e.g., wheel swarf or similar materials. Consequently, scrap is classified as a primary tungsten raw material. This is shown in Figure 26.3, which also shows that approximately one-third of demand is supplied from scrap [14].

The processing of scrap is environmentally beneficial. No energy is required for mining and preparation, and no chemicals for concentration processes. This reduces both atmospheric pollution and chemical waste. Especially important for the future is the fact that scrap recycling conserves reserves of ore.

Scrap is classified as either "hard" or "soft". Soft scrap is finely divided material, e.g., powder, dust, grindings, and turnings, with tungsten content 10–98%. Hard scrap is in lump form (sintered material, scrap bar and sheet, wire, etc.) with tungsten content 40–99.9%.

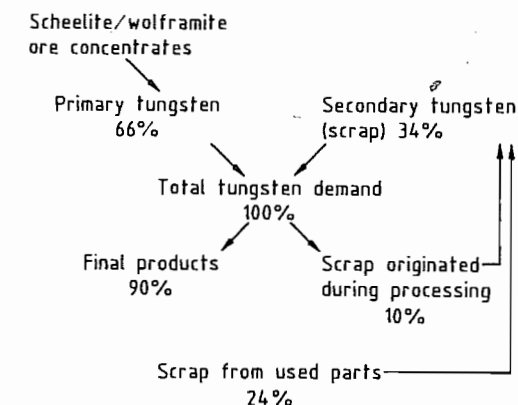

Figure 26.3: Tungsten flowchart.

## 26.4 Production

### 26.4.1 Ore Beneficiation

Most tungsten ores contain less than 1.5% WO<sub>3</sub>. Therefore, ore-dressing plants are always in close proximity to the mine to keep transport costs low. The first steps in the procedure are crushing and milling to liberate the tungsten mineral crystals from the gangue materials. The final grain size to which the ore must be reduced depends on the size of mineralization present in the tungsten ore body. This can be quite different from deposit to deposit. The finer the mineralization, the more costly the pretreatment and the lower the recovery. No more crushing and milling should be applied than is absolutely required, to minimize losses.

**Scheelite Ore.** After crushing, coarsely crystallized scheelite can be concentrated by gravimetric methods (hydrocyclones, tables, spirals, etc.). Finely mineralized scheelite, however, has to undergo froth flotation. A very high purity may be obtained by gravity

methods (sometimes > 90% scheelite in the concentrate). The yield is normally 60–70% and sometimes 80–90%. The flotation process allows recoveries of 80–90%. Modern plants combine gravimetric and flotation methods because on disintegration some of the scheelite crystals are broken into fine particles which are lost if only gravity methods are used (scheelite is very brittle). The fine particles can be recovered in a subsequent flotation step. Typical commercial concentrates contain > 70% WO<sub>3</sub>. Fully downstream integrated plants that process their concentrates themselves keep the final WO<sub>3</sub> concentration in the flotation process low (5–40%) to minimize losses, giving overall yields of > 90%.

**Wolframite Ore.** Gravity methods are used for wolframite ore, sometimes in combination with magnetic separation. The weakly magnetic wolframite properties enable a further concentration. Commercial concentrates should assay > 65%.

## 26.4.2 Pretreatment of Ore Concentrates and Scrap

Hydrochloric acid leaching of scheelite concentrates at room temperature is used to reduce phosphorus, arsenic, and sulfur content [4].

Calcination in air (500–600 °C) is used to oxidize organic flotation agents which could have a detrimental effect on subsequent processing [15, 16]. Also, in mixtures of concentrates with high sulfide and calcium carbonate contents, gypsum is formed [16], and arsenic and sulfur are removed if they are present in high concentrations in wolframites.

Grinding is necessary for scheelite concentrates produced by gravity methods, and with all wolframite concentrates.

Oxidation of soft scrap by heating in air at 700–800 °C allows the tungsten to be dissolved in subsequent pressure leaching processes [17].

## 26.4.3 Hydrometallurgy

This section deals with the production of high-purity ammonium paratungstate (APT), which is now the most important raw material for all other tungsten products. Only the modern process is described; a comparison with classical methods [7] is given in Figure 26.4. The most important differences are:

- The use of solvent extraction instead of precipitation of CaWO<sub>4</sub> to convert the sodium tungstate solution to ammonium tungstate solution, followed by decomposition to H<sub>2</sub>WO<sub>4</sub>.
  - Conversion of the tungsten in aqueous solution to a solid compound by crystallization rather than precipitation. Each crystallization is a slower process than immediate precipitation, and therefore leads to a purer product.
- The advantages of the modern process are:
- The possibility of using various raw materials (wolframite, scheelite, scrap)
  - Better energy efficiency
  - Less labor required
  - Ease of automation
  - Higher yields
  - Uniformity and higher purity of the product

A flow diagram of a modern APT production plant based on various raw materials is shown in Figure 26.5.

### 26.4.3.1 Digestion

Wolframite concentrates can be dissolved either at atmospheric pressure with concentrated NaOH solution (40–50%, 15 mol/L) at 100–145 °C followed by dilution [18], or by high-pressure digestion with dilute NaOH solution [19].

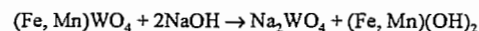

Scheelite concentrates are always leached with Na<sub>2</sub>CO<sub>3</sub> solution under pressure [4]. The process requires a large excess of reagent, but gives a milder reaction with respect to dissolution of gangue, and can be carried out in mild

steel autoclaves (NaOH treatment requires Inconel cladding).

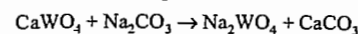

Mixtures of concentrates of wolframite and scheelite can be dissolved by Na<sub>2</sub>CO<sub>3</sub> solutions with addition of NaOH under pressure [20]. Oxidized soft scrap is digested with NaOH solution, as in the treatment of wolframite [15].

Information on the parameters and yields for various chemical leaching processes is given in Table 26.2.

### 26.4.3.2 Purification

The sodium tungstate solution obtained by leaching the ore contains amounts of dissolved impurity elements depending on the composition of the raw material. If the concentration of

these elements is too high, subsequent processing may be disturbed or the end product may have too high an impurity level. Purification is carried out by precipitation and filtration.

**Silicate Precipitation.** Silicates are common gangue minerals which dissolve on pressure leaching, at least partially. Dissolved silicate can be precipitated by the addition of an aluminum sulfate or magnesium sulfate solution, or a mixture of the two at pH 8–11 [21]. The chemistry of the precipitation is complex and has not been investigated in detail. With higher silicate content, a two-stage precipitation with a mixture of aluminum and magnesium sulfates is preferable, enabling the SiO<sub>2</sub> content to be reduced to 3060 mg/L [4].

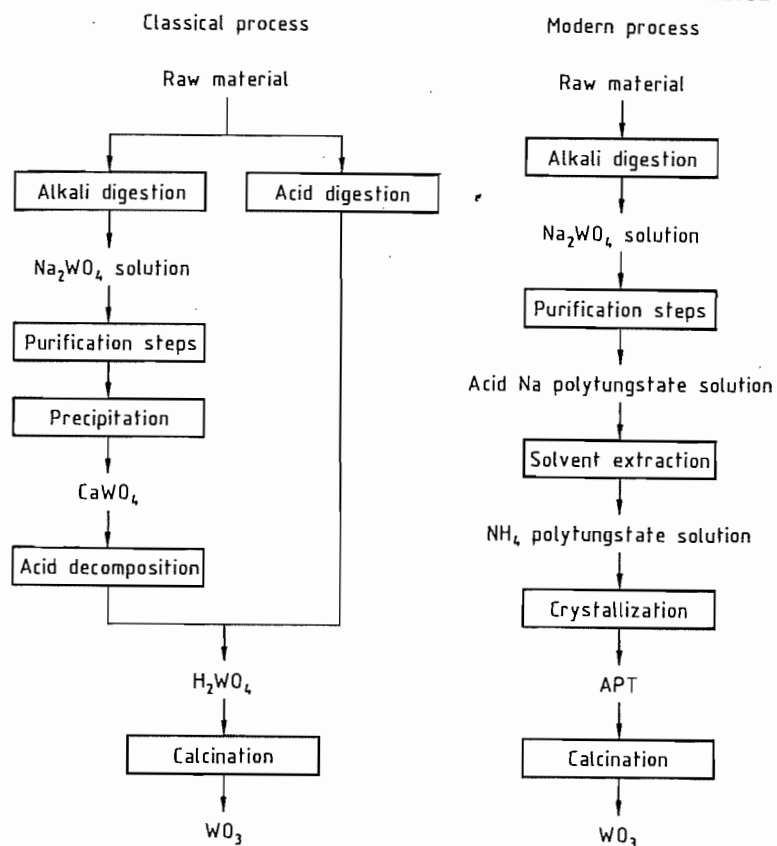

Figure 26.4: Comparison of classical and modern WO<sub>3</sub> production.

Table 26.2: Typical parameters for pressure leaching of tungsten raw materials.

	Scheelite concentrate	Wolframite concentrate	Oxidized scrap
Particle size, $\mu\text{m}$	< 44 to < 90	< 44	< 100
Temperature, $^{\circ}\text{C}$	190–225	175–190	150–200
Pressure, MPa	1.2–2.6	0.8–1.2	0.5–1.2
Time, h	1.5–4	4	2–4
Reagent concentration, %	10–18 ( $\text{Na}_2\text{CO}_3$ )	7–10 (NaOH)	20 (NaOH)
Molar ratio $\text{WO}_3$ :reagent	1:2.5–4.5	1:1.05	1:1.4

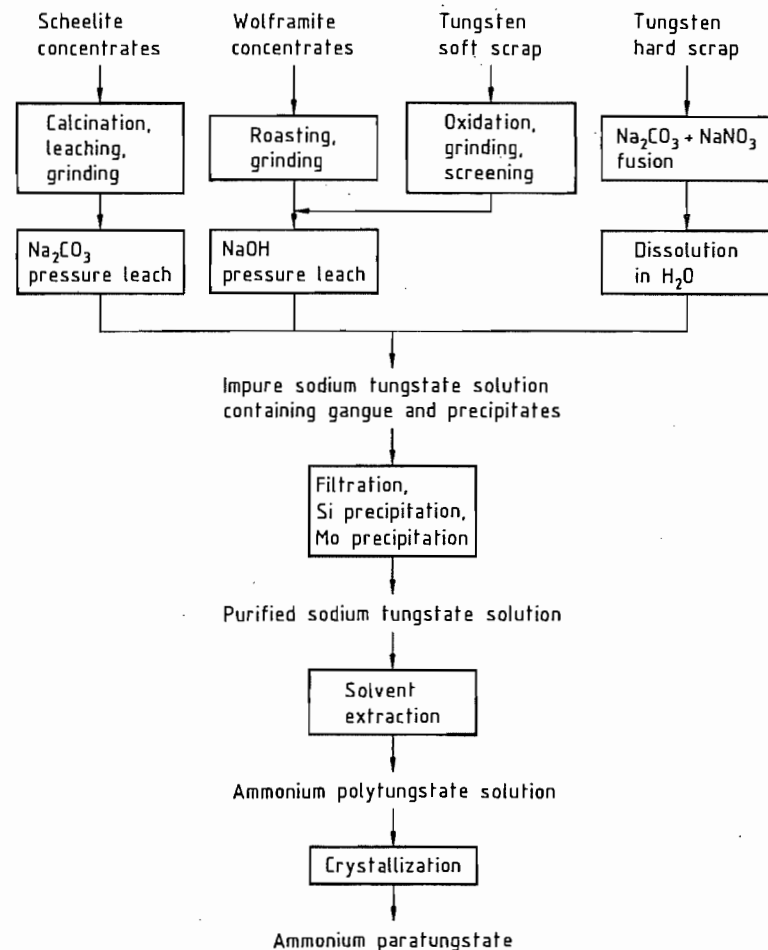
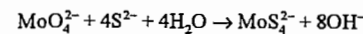

Figure 26.5: The modern APT process.

This precipitation technique reduces not only the silicate content, but also the phosphate and fluoride concentration. Precipitation is first performed with magnesium sulfate at pH 10–11, and then with aluminum sulfate at pH 7–8 [22].

**Molybdenum Precipitation.** Molybdenum is a very common companion element in tungsten ores. It remains in the concentrate and goes into solution on chemical digestion, either completely or partially. Precipitation is carried out by adding excess sodium sulfide to

the neutral or mildly alkaline solution, forming thiomolybdate:



The solution is then acidified with sulfuric acid to pH 2.5–3.0. This causes the molybdenum to be precipitated as the trisulfide [20]:

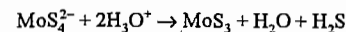

This purification stage is not only effective for Mo, but also removes a number of other elements that form insoluble sulfides, e.g., As, Sb, Bi, Pb, and Co.

**Solvent Extraction** [4, 23], (Figure 26.6)

The sodium tungstate solution (pH 2–3) is contacted with the organic phase, which extracts the isopolytungstate ions as an ion associate complex. Mixtures of tertiary or secondary aliphatic amines (e.g., trioctylamine) with isodecanol and kerosene form the organic phase. The amine is the reagent that forms the ion associate complex, the isodecanol increases the solubility of the complex (modifier), and kerosene is the solvent.

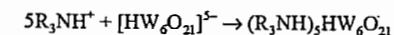

Table 26.3: Maximum impurity concentrations in APT crystallization.

Element	Feed solution, mg/L	Mother liquor, mg/L	APT, ppm
Al	< 10	< 100 <sup>a</sup> < 3000 <sup>b</sup>	< 10
As	< 50	< 2000	< 20
F	< 250	< 3000	< 10
Fe	< 10	< 200	< 10
Mo	< 10	< 60	< 20
Na	< 10	< 100	< 10
P	< 50	< 400	< 20
Si	< 10	< 200	< 20
V	< 100	< 1200	< 20

<sup>a</sup> In absence of fluoride.

<sup>b</sup> For fluoride concentration of ca. 4000 mg/L.

### 26.4.3.3 Conversion of Sodium Tungstate Solution to Ammonium Tungstate Solution

In modern plants, this reaction is now carried out exclusively by solvent extraction or ion exchange resins. The sodium ion concentration must be reduced from ca. 70 g/L to < 10 mg/L, as sodium levels > 10 ppm in the APT cause problems during the reduction to metal powder.

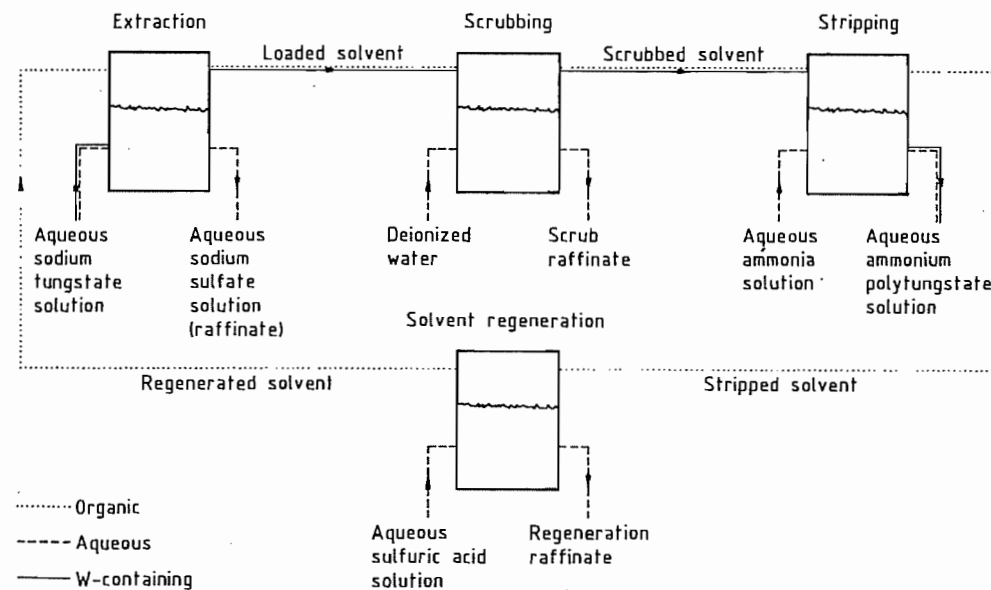
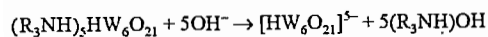

Figure 26.6: Tungsten solvent extraction.

The extract is washed with deionized water, and the isopolytungstate is then reextracted with dilute ammonia solution into an aqueous phase:



The solvent goes through a regeneration stage and is then returned to the extraction process.

### Ion Exchange Process [24, 25]

This process is now used only in small plants in China. A strongly alkaline ion exchange resin in the chloride form is used. On contact with the sodium tungstate solution, the tungstate is adsorbed. Desorption is carried out with ammonium chloride solution. Elements that form heteropolytungstates, e.g., Si, P, As, and Mo, can be removed.

### 26.4.3.4 Crystallization of Ammonium Paratungstate (APT) [26]

This compound has the formula  $(NH_4)_{10}(H_2W_{12}O_{42}) \cdot 4H_2O$ .

On evaporation of the isopolytungstate solution, water and ammonia are distilled, the pH of the solution decreases, and the sparingly soluble APT crystallizes [27, 28]. The ammonia-water mixture is condensed and recycled to the solvent extraction process. The crystallization conditions are used to control the physical properties that influence the subsequent processing to give tungsten powder. The process is carried out batchwise or continuously in recirculating crystallizers with partial recycling of mother liquor (to maintain the concentration of impurities in the mother liquor and hence in the crystals formed). Owing to the low solubility of APT compared with the impurities in the mother liquor, this process step represents not only a conversion from the dissolved form to a solid, but also a very important purification (Table 26.3).

### 26.4.4 Calcination of Ammonium Paratungstate [4, 21]

On heating APT to 400–800 °C, ammonia and water are evolved. This decomposition becomes more complete as the temperature and duration of heating are increased. The form of the solid phase is determined by the decomposition temperature, the retention time in the reactor, and the reduction potential of the decomposition atmosphere. If heating takes place with air addition, yellow  $WO_3$  is obtained; with exclusion of air, blue oxide. In the blue oxide, some tungsten atoms are pentavalent, owing to  $H_2$  reduction ( $NH_3$  decomposition). Unlike the yellow oxide, blue oxide is not a single, well-defined chemical compound. It contains  $WO_3$  together with the oxides  $W_{20}O_{58}$  and  $W_{18}O_{47}$ , depending on the decomposition conditions, and also ammonium and hydrogen tungsten oxide bronzes (residual  $NH_3$  and  $H_2O$  content). Nevertheless, it is currently used more than the yellow oxide.

On an industrial scale, calcination is usually carried out in rotary furnaces, more rarely in pusher furnaces. The former yield a more uniform product. The chemical composition and micromorphology of the oxide particles are determined by the duration and temperature of heating. The micromorphology is very important in the production of submicron tungsten powders.

### 26.4.5 Reduction by Hydrogen to Tungsten Metal Powder [29–31]

The production of tungsten metal powder is today carried out almost exclusively by the hydrogen reduction of high-purity tungsten oxides ( $WO_3$ ,  $WO_{3-x}$ ). Reduction of the oxide by carbon is now used only for the production of tungsten carbide (direct carburization). The reduction of tungsten halides (Axel Johnson process) has not become established on a large scale.

The reduction of tungsten trioxide or blue oxide can be controlled by the temperature and the water vapor partial pressure.

At lower temperatures (600 °C) and lower moisture contents, the reduction proceeds by solid-state diffusion of the oxygen out of the oxide, and can be represented by the following equation:

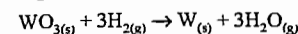

On complete reduction, an oxide-pseudomorphic metal sponge is formed.

At higher temperatures and moisture contents, the reaction proceeds stepwise via the oxides  $W_{20}O_{58}$ ,  $W_{18}O_{47}$  and  $WO_2$  to tungsten metal. Only the first transformation to  $W_{20}O_{58}$  and each nucleation of a newly formed phase on further reduction are solid-state reactions. All other transformations are linked with gas-phase transport of tungsten as the volatile oxide hydrate  $WO_2(OH)_2$ , and are associated with a significant change in shape of the crystal faces. The formation of the vapor-phase oxide hydrate takes place by reaction of the corresponding suboxide with water formed in the reduction. The vapor pressure of the oxide-hydrate in equilibrium with a stable compound formed under the reaction conditions is lower than that in equilibrium with the continually decreasing amount of the unstable compound. As a result of these gradients, chemical vapor transport (CVT) takes place, so that the higher oxide decreases in quantity, and the lower oxide increases. The interphase reaction can plausibly be divided into three steps:

- Formation of  $WO_2(OH)_2$  from the oxygen-rich compound with  $H_2O$

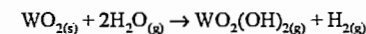

- Transport of  $WO_2(OH)_2$  to the compound of lower oxygen content
- Reduction of  $WO_2(OH)_2$  by hydrogen at the surface of the compound of lower oxygen content (or the metal)

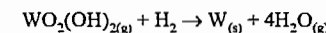

Formation of a new phase must be preceded by nucleation. This takes place on the surface of the reacting oxide if the water vapor pressure is lower than the equilibrium water vapor pressure for the phase transformation concerned. The nucleus then continues to grow as described above.

Reduction on an industrial scale is carried out in pusher furnaces, in which the powder passes through the furnace in boats, or in rotary furnaces. Walking beam furnaces or furnaces with internal band conveyors are less often used. Furnaces are provided with several temperature zones controllable between 600 and 1100 °C. The flow of hydrogen is usually in a countercurrent direction, more rarely cocurrent, and a drying stage is always included in the circuit, as a large excess is used. The hydrogen acts not only as a reducing agent, but also carries away the water formed. The flow rate is therefore one of the parameters for controlling the water vapor partial pressure. Other control parameters are:

- The amount of oxide charged to the furnace per unit time
- The depth of the oxide bed
- The porosity of the oxide bed (particle size and particle size distribution)
- The moisture content of the hydrogen entering the furnace

The porosity and depth of the bed, in conjunction with the  $H_2$  flow rate, determine the rate of diffusion of water vapor from the bed.

In practice, the average grain size of the tungsten powder (0.1–60  $\mu m$ ) is controlled empirically by setting the temperature, oxide quantity, heating time, and  $H_2$  flow rate. In general, these have the following effects:

- Fine Powder: lower temperature, low bed depth, long dwell time, and high  $H_2$  flow rate. These conditions correspond to a low water vapor partial pressure (and hence a more rapid nucleation rate), low crystal growth rate via the gas phase and short transport distances of  $WO_2(OH)_2$ . The furnace capacity is low.
- Coarse Powder: high temperature, greater bed depth, lower heating time, lower  $H_2$  flow rate. These conditions correspond to a high water vapor partial pressure, a lower rate of nucleation, and more rapid transport via the gas phase over longer distances. The furnace capacity is high.

In the powder bed, there is a water vapor concentration gradient, as diffusion from the interior takes longer than from the outer parts. This leads to a grain size distribution in the tungsten powder; the powder in the interior of the bed is coarser than that in the outer zones and at the surface.

Doping with low concentrations of alkali metals (Na or Li salts) catalyzes crystal growth during the reduction process, and enables coarser tungsten powders (100–200  $\mu\text{m}$ ) to be produced [32].

### 26.4.6 Production of Compact Metal

Conversion of tungsten metal powder to compact metal is carried out exclusively by powder metallurgy, i.e., by a heat treatment (sintering) of a compacted preform.

**Compaction.** In the first step, the powder is compacted hydraulically or mechanically by a polydirectional pressure of 200 MPa (2000 bar) to produce preforms—rods or plates that have edge stability and are of the correct dimensions. Circular blanks with a low height/diameter ratio and small items such as pins are produced in automatic presses at high outputs. The raw material for this must consist of free-flowing granules similar to the granulated hard metals produced in spray drying equipment [33].

**Sintering.** Pure tungsten is today sintered almost exclusively by the economic indirect sintering process. Furnaces for this consist of tungsten heating elements surrounded by radiation shielding made of tungsten sheets on the inside and molybdenum on the outside, and are purged with hydrogen as a protective gas. At maximum sintering temperature (2800 °C), sintering times of several hours are required. In the production of so-called non-sag tungsten for incandescent lamp manufacture, direct sintering, i.e., by passage of an electric current, is usual. In both processes, the sintered densities achieved are ca. 95% of theoretical.

The weight of individual sintered tungsten components is usually 1–100 kg. The choice of optimum sintering parameters greatly influences the structure and hence the strength and ductility of sintered tungsten.

In the direct sintering process, very high sintering temperatures, and hence short sintering times can be used. However, the practical limits on rod dimensions and production rates are a considerable disadvantage, and electricity costs per kilogram are significantly higher than with indirect sintering. Also, the fixing points, which are poorly sintered, must be knocked off the rod, causing further loss. Disadvantages of the indirect sintering process include the high cost of the plant and heating elements. Nevertheless, overall this process is considerably more economic, and it is the only process that allows the sintering of preforms.

Another important aspect is that sintering is an extremely effective purification process, removing a high proportion of impurities from the material. The hydrogen flow rate during sintering should therefore be high enough to transport the impurities away.

**Melting.** Approximately since the 1950s, i.e., after the development of electric arc melting plants and high-capacity vacuum equipment, it has been possible to melt highly refractory metals on an industrial scale. Some time later, trials on plasma melting and electron beam melting of tungsten showed that these processes led to a product with extremely coarse crystals and hence poor working properties, so these melting processes are of no technical value for tungsten (unlike molybdenum and its alloys). Electron beam zone melting is in fact used in the production of single crystals of tungsten [5], but these products have only a few special uses as production costs are high.

### 26.4.7 Processing of Sintered Parts

#### 26.4.7.1 Shaping

Completely dense, pore-free bodies cannot be obtained by sintering, the residual porosity being 3–10%. To obtain a completely dense

material, a complex multi-stage forming process is required. Tungsten can be shaped by all the usual forming processes, e.g., forging, rolling, extruding, and wire drawing. The first forming step is usually carried out at 1500–1700 °C. Many reheating stages are necessary in the first stages of shaping, as the heat is rapidly lost at these temperatures and a stress-relieving operation below the recrystallization temperature is often advantageous. Intermediate heating operations are necessary for recrystallization. The forming temperature is progressively reduced, since the recrystallization temperature decreases as forming proceeds. To give a well-defined fiber structure (high degree of deformation), a final cold forming can be carried out, as already stated.

**Chipless Forming, Including Stamping and Cutting.** The temperature range for the forming of tungsten has a lower limit, set by the transformation temperature, and an upper limit, set by the recrystallization temperature. Thin, strongly deformed sheet and foil have a pronounced structure in the longitudinal direction due to elongation of the grains during rolling. The bending properties along the direction of rolling are therefore different from those across it. Tungsten sheet should therefore always be bent perpendicular to the rolling or longitudinal direction. If bending in the longitudinal direction cannot be avoided, owing to the design, a much higher temperature is required.

Tungsten can also be formed at high temperatures by pressing, flow-turning (spinning), or forging.

Die stamping of tungsten sheet is possible if the working temperatures of the sheet and the tool are kept high.

Tungsten can be punched and forged at high temperatures. Blunt edges on punching tools and shears, or low punching or cutting temperatures can cause cracking and splitting.

**Machining.** Tungsten can be drilled, turned, milled, planed, and ground. However, machining operations require great experience and close adherence to optimum conditions [3]. Complex shapes and holes can be produced by

spark erosion; the tungsten workpiece forms the anode and the working electrode the cathode. Suitable electrode materials can be based on tungsten-copper.

#### 26.4.7.2 Mechanical Bonding of Tungsten to Tungsten and Other Metals

**Rivets.** Tungsten components can be bonded together or to components made of other metals by means of rivets, provided the joint need not be impermeable to liquids and/or gases. Tungsten rivets and round-head and counter-sunk molybdenum rivets can be used.

**Brazing.** The parts to be joined must be free from grease, oils, oxides, or other impurities, and should preferably be etched immediately before brazing. As tungsten is very sensitive to oxidation, it is preferable to carry out the operation under a protective gas, hydrogen, or vacuum. Parts with a large surface area or of complex geometric shape should be brazed in a furnace with the aid of a special jig. If brazing temperatures exceed 1150 °C, there is a possibility of recrystallization. Typical brazing metals and temperatures are: Rh (1970 °C), Pd (1550 °C), CuNi45 (1300 °C), etc. [3].

**Welding.** Tungsten has only moderate welding properties. The weld seams have a coarse-grained structure in the hot fusion zone, owing to recrystallization, and can therefore withstand only low mechanical stresses. If welding is unavoidable, weld seams should if possible be located in regions of low internal and mechanical stress. It is preferable to locate weld seams as far as possible from the edges or ends of fabricated articles.

Tungsten inert gas (TIG) welding can be performed in protective gas chambers. However, in electron beam welding, the melting and hot fusion zones are much more limited in size, so this technique is preferable for welding tungsten. It is advantageous to preheat the parts to be joined to ca. 700–800 °C by a defocused electron beam immediately before welding. Welded components should be

cooled as slowly as possible. Tungsten can be electron beam welded to tungsten-rhenium and molybdenum-rhenium alloys, copper, and stainless steel. Tungsten-rhenium alloys are recommended as filler metal for welding tungsten.

As fusion welding can be used only under certain circumstances, diffusion welding of tungsten to tungsten and to other metals is important. Despite the high melting point of tungsten, temperatures of 1300–2000 °C and pressures of 2–20 N/mm<sup>2</sup> give satisfactory joints. The diffusion welding of tungsten is carried out in either vacuum or pure hydrogen.

Thin intermediate layers in the form of films of nickel, platinum, rhodium, ruthenium, and especially palladium, considerably accelerate the diffusion processes.

Tungsten wires and small tungsten components can be bonded to fusible alloys based on iron-nickel-cobalt and to other metals by spot welding under a protective gas blanket. The use of small pieces of foil made of platinum, niobium, tantalum, or zirconium is recommended. Laser beam welding of tungsten is likely to become very important in the future.

### 26.4.8 Surface Treatment

Tungsten components can be degreased with trichloroethylene, perchloroethylene, and similar solvents.

Tungsten can be etched with alkaline and acid media. Whereas oxidized tungsten is more easily cleaned with alkaline etchants, grinding residues and metallic contamination are more easily removed by acids; very clean tungsten surfaces can be obtained by alkaline etching followed by acid etching.

An alkaline etchant can consist of molten NaOH containing 10% NaNO<sub>2</sub>. The melt temperature is 400–450 °C. Thin oxide films can also be removed by dipping tungsten in alkaline solutions of K<sub>3</sub>[Fe(CN)<sub>6</sub>]. Other common alkaline etchants are 10% solutions of NaOH or NH<sub>3</sub>/H<sub>2</sub>O<sub>2</sub>. Acid etchants usually consist of HNO<sub>3</sub>/HF/H<sub>2</sub>O mixtures. Other commonly used mixtures are HNO<sub>3</sub>/HF/CH<sub>3</sub>COOH and HClO<sub>4</sub>/H<sub>3</sub>PO<sub>4</sub>/H<sub>2</sub>O.

**Electropolishing.** Tungsten can be anodically electropolished in a K<sub>2</sub>CO<sub>3</sub>/KClO<sub>3</sub>/NaOH/H<sub>2</sub>O mixture. Another possible electrolyte is CH<sub>3</sub>OH/H<sub>2</sub>SO<sub>4</sub>/HF.

### 26.4.9 Tungsten Coatings

Tungsten coatings are applied to metals, glass, ceramics, semiconductors, inorganic woven products, uranium carbide nuclear fuel granules, etc., for a large number of reasons, including the improvement of wear resistance, corrosion resistance, emissivity, and high-temperature properties [5]. The most important processes used today are:

**Plasma Spraying.** This process is often used to apply very thick tungsten coatings (e.g., in the construction of engines and rockets), as the flame spraying process (used successfully with molybdenum) cannot be used with tungsten. The cathode material in the plasma burner is also tungsten.

**Vacuum Vapor Deposition, Ion Sputtering, and Physical Vapor Deposition (PVD).** In most of the usual coating processes, the substrate material must be raised to a high temperature, which usually has a detrimental effect on its mechanical properties. When tungsten is deposited by vacuum vapor deposition or ion sputtering onto a relatively cool substrate, these problems can be largely avoided. These coating methods are therefore very useful for metallizing semiconductors, ceramics, glasses, and also metals. The coatings are comparatively thin, but adhere well [34].

**Deposition from the Vapor Phase, Chemical Vapor Deposition (CVD).** Suitable readily vaporizable tungsten compounds include chlorides, fluorides [35], carbonyl compounds, and organometallic tungsten compounds. The carrier gas is hydrogen or a noble gas. Tungsten and tungsten alloys are applied in this way to, e.g., nuclear fuels (UC, UO<sub>2</sub>), metallic substrates, and semiconductors. Small tungsten components are today manufactured by CVD.

**Electrolytic Methods.** Although there is an extensive patent literature [5] on the electrolytic deposition of tungsten coatings on metallic substrates, the method is not of practical significance. The production of tungsten coatings by diffusion, metallization, or cladding (including explosion cladding), has often been proposed, but has not become established as an alternative to other methods.

### 26.4.10 Production of High-Purity Tungsten Metal (99.999–99.9999 %)

The starting material is ammonium paratungstate (APT) of normal purity, but with uranium and thorium contents as low as possible. Important steps to high purity include:

- Selective extraction of uranium and thorium [36]
- Multiple crystallization of APT (giving a general reduction in the various trace impurities)
- Working under clean-room conditions [38]
- Electron beam zone melting [37, 39]

## 26.5 Uses

The uses of tungsten, its alloys, and compounds are extremely diverse. They can be divided into the following large groups (by consumption):

Hard metals	50–60%
Steel	20–30%
Tungsten metal and its alloys	6–20%
Tungsten chemicals (for uses, see Section 26.7)	4–8%

**Hard Metals.** These products represent by far the largest consumption of tungsten worldwide. With few exceptions, their main component is tungsten carbide (WC). Carbides, nitrides, or carbonitrides of Ti, Nb, Ta, and Hf can also be present as mixed crystal formers. The hard material phases are bonded together by a ductile metallic phase that surrounds them (cemented carbides), usually Co, more rarely Ni or Fe alloys.

The outstanding properties of the hard metals are their high hardness and wear resistance, especially at high temperatures, combined

with good toughness properties. This unusual combination of properties is achieved by combining the hard and brittle carbide phase(s) with the ductile and deformable binder. By varying the carbide/binder ratio, and by suitable choice of the carbide composition, the properties can be varied within wide limits. A further control parameter for certain properties is the microstructure, i.e., the grain size of the carbide phase(s), which can be controlled via the particle size of the powder used, the powder milling, and the sintering conditions.

The most important groups of applications of hard metals are:

- Metal cutting tools (drilling, turning, milling)
- Tools for processing wood and plastics
- Drilling tools in mining and mineral oil and water drilling technology
- Wear-resistant components in a wide range of machinery (a continuously increasing group with the widest diversification)
- Elastically bonded abrasive materials

**Steel.** Tungsten is added to a very wide range of steels in a concentration of 1–18%. It increases the hardness and wear resistance at high temperatures (carbide formation), resistance to thermal shock, and high-temperature properties. The main areas of use are in high-speed steels, high-temperature steels, and tool steels. The use of tungsten in steel is significantly greater in China and the former Eastern Bloc countries, as high-speed steel is still used for many applications rather than hard metals, as in the West. In the United States, tungsten has mainly been replaced by molybdenum in high-speed steels.

**Tungsten and Tungsten Alloys.** This group represents the widest range of uses. It extends from everyday uses, e.g., the coil of an incandescent lamp or the contact tip of an automobile horn, to components of nuclear fusion reactors or ion drive motors in space probes. The reason for this range of uses lies in the many outstanding properties of tungsten:

- High melting point
- Low vapor pressure

- High atomic number
  - Good electrical and thermal conductivity
  - High density and modulus of elasticity
  - Wide radiation band in visible light and good light yield
  - Good X-ray yield
  - Expansion coefficient comparable to those of glass and silica
- The following list shows this versatility very clearly.

- **Lighting Technology**

- Incandescent lamps (NS-W)
- Halogen lamps (NS-W)
- Gas discharge lamps: Hg, Na vapor lamps (W)
- Fluorescent tubes (W)
- Xe short arc lamps (W, W-ThO<sub>2</sub>, W-Re)

- **Electrical and Electronic Technology**

- Sputter targets in VLSI technology (W-Ti, high-purity W)
- Transistors (W)
- Diodes (W)
- Electronic tubes (W, W-ThO<sub>2</sub>, porous W with Ba or ThO<sub>2</sub>)
- Thyristors (W)
- Switch contacts [W, W-Cu, W-Ag, W-Fe-Ni-(Cu)]
- Heat sinks (W-Cu)

- **High-Temperature Technology** (furnace construction, nuclear energy, thermal power stations)

- Structural components (W)
- Walls of fusion reactors (W, W-Re-ThO<sub>2</sub>, W-Re-HfC)
- Construction components in the plasma space in magnetohydrodynamic electricity production (W, W-Cu)
- Thermocouple elements (W/WRe, W/Mo, W/Ir, W/graphite)
- Heating elements (W)

- **Vacuum and Plasma Metallization, Welding, Spark Erosion**

- Nozzles (W-ThO<sub>2</sub>)

- Electrodes [W-ThO<sub>2</sub>, W-Ag, W-Fe-Ni(Mo)]

- Welding electrodes (W-ThO<sub>2</sub>, W-LaO<sub>2</sub>, W-CeO<sub>2</sub>, W-ZrO<sub>2</sub>, W-Y<sub>2</sub>O<sub>3</sub>)

- **X-Ray and Radiation Technology, Medical Technology**

- Anodes (W)
- Rotating anodes (W-Re)
- Containers for radioactive materials (W-Fe-Ni)
- Components for radiation shielding, e.g., collimators in computer tomography scanners [W-Fe-Ni-(Cu)]

- **Machinery and Motor Construction**

- Governor balance weights, counterbalance weights, flywheel weights and other weights, e.g., in Formula 1 racing cars [W-Fe-Ni(Cu)]

- **Chemical Industry**

- Electrodes, nozzles, crucibles (W)
- Construction materials (W-Mo)

- **Space Travel**

- Rocket nozzles (W, W-Ag)
- Space nuclear reactors (W-Re)
- Thermionic converters (porous W, CVD-W, W-Re)
- Ionic reactive thrust motors (porous W)
- Structural components (tungsten fiber-reinforced niobium matrix composites, superalloys, Al, Ti)

- **Armaments**

- Armor piercing shells, armor plating, scatter grenades, shaped charge liners, counterweights in tanks, nozzles for air-to-air rockets, gas rudders (W-Fe-Ni, W-Cu, W-ThO<sub>2</sub>)

- **Aircraft**

- Aircraft nose counterweights (W-Fe-Ni)
- Turbine blades of fiber-reinforced nickel-based superalloys (W-Re-ThO<sub>2</sub> and W-Re-HfC fibers)

- **Laser Technology**

- Cathodes (porous W/barium aluminate)
- Components of gas lasers (W-Cu)

## 26.6 Analysis

### 26.6.1 Raw Materials

The determination of the tungsten content of ore concentrates and scrap is very important, as the price is calculated from this. Sampling procedures are also extremely important, as the high density of tungsten can easily lead to segregation [40]. Determination of tungsten itself is almost exclusively carried out by X-ray fluorescence analysis [41]. Thus, matrix effects are compensated for by dissolution and dilution, and by the addition of an internal standard. Molten lithium tetraborate is widely used as a solvent, with tantalum pentoxide as an internal standard. Matrix corrections are carried out with computer programs.

### 26.6.2 High-Purity Intermediate Products, Tungsten Powder, and Compact Tungsten Metal

In these materials, it is not sufficient to determine the tungsten. In any case, especially in the metallic state (99.97–99.98% W) this would be far too inaccurate. Here, it is important to measure trace impurity contents. In all these products, the specifications applicable are very rigorous, setting maximum acceptable upper limits for concentrations of individual elements. For industrial tungsten and its high-purity precursor materials, these are all in the µg/g range, the maximum tolerable level for most elements being 10 µg/g. Exceptions include Mo (50 µg/g), Si (20 µg/g), and H (1 µg/g).

Routine determination of trace elements is mainly carried out by the following methods:

- Flame atomic absorption spectrometry
- Graphite tube atomic absorption spectrometry
- Inductively coupled plasma optical spectrometry
- Photometry
- Vacuum fusion hot extraction (H, N)
- Carrier gas hot extraction (O)

- Ignition in oxygen combined with IR spectrometry (C)

Up-to-date literature on this topic is rare, as improved and refined analytical methods are increasingly regarded as industrial secrets. The determination of metallic trace impurities is described in [42, 43], and of nonmetallic trace impurities in [44–46].

Large samples are always used. The result therefore always represents a mean value. Also, these analyses give no information on the distribution of a trace element and its state of bonding in the compact metal [47, 48]. It is well known that impurities can exist in various forms and states of combination in metals (dissolved interstitially or as mixed crystals, as precipitates in the crystal or at grain boundaries, etc.). This knowledge is often important for subsequent treatment processes or for the final properties. Topochemical analytical methods are also used:

- Scanning electron microscopy coupled with energy or wavelength dispersive X-ray spectrometry
- Auger electron spectroscopy
- Auger microprobes
- Ion beam microprobes UV and X-ray photoelectron spectrometry, etc.

These techniques are not used routinely, mainly because of their cost, but for special applications and in research.

Heterogeneous impurities represent a special case (though often widely occurring) of particular importance in powder metallurgy. These impurities are small foreign particles present in a certain statistical distribution alongside the matrix particles. In most cases, they are due to mechanical abrasion or corrosion of production equipment. They can become concentrated in furnaces by vaporization, and can then end up in the material. Organic materials can also be present in the powders, e.g., fibers from filter cloths, packing materials, or plastic films. The various types of heterogeneous impurities, their effects, and their analytical determination are described in [49–52].



The presence of this type of heterogeneous impurity can lead to very serious material defects on powder metallurgical processing. Unlike molten metallurgical processes, where small foreign particles can dissolve in the homogeneous melt or slag, and hence cause very little change to the composition, the sintering of a compact can still leave locally high concentrations of a foreign element. Consequently, many kinds of defects can occur, e.g., empty or filled pores, porous zones, zones with completely changed material properties, etc., leading to fractures and cracks on subsequent processing. Fine wires and thin sheets are therefore extremely sensitive to heterogeneous impurities.

In the characterization of tungsten powder, physical analysis is important as well as chemical analysis [53]. Typical powder characteristics include:

- Mean grain size (Fisher sub-sieve sizer, ASTM No. 430-1970)
- Morphology, heterogeneity (scanning electron microscopy, SEM)
- Particle size distribution (sedimentation, laser scattering, ultracentrifuge)
- Bulk, tapped, and pressed density
- Specific surface area (BET method)
- Degree of agglomeration

### 26.6.3 Trace Elements in High-Purity Tungsten Metal

In high-purity tungsten metal, levels of trace elements are in the ng/g range. There are therefore special analytical requirements:

- Working in a clean-room laboratory
- Prevention of any other contamination
- Correct calibration, etc.

Comparisons between various methods and laboratories show clearly that in trace analysis of this kind the results can have considerable scatter [54, 55]. The analytical techniques are always very complex and expensive, the most important being:

- Glow discharge mass spectrometry
- Secondary ion mass spectrometry

- Isotope dilution mass spectrometry
- Trace matrix separation combined with inductively coupled plasma mass spectrometry

Very significant improvements in this type of analysis have been achieved, especially in recent years [38].

## 26.7 Compounds and Intermetallic Compounds

### 26.7.1 Tungsten Chemistry

Tungsten occurs in all oxidation states from 2+ to 6+ inclusive, the most important being 6+. Valencies between 2- and 1+ exist only in organometallic compounds and compounds with  $\pi$ -acceptor ligands. In the lower valencies, tungsten forms bases (sometimes unstable), but in the higher valencies it forms very stable acids.

Tungsten combines with most elements and with a large number of inorganic and organic ligands. The highest coordination number is 8, and the most important donor atoms are O, N, S, and the halogens. Tungsten has a very marked tendency to form polymeric compounds.

This chemistry is extremely complex [58, 59], as the tungstate anion exists in monomeric form only in strongly alkaline solutions. In mildly alkaline solution, the tungstate anions begin to polymerize, and this progresses with decreasing pH. Below pH 1, sparingly soluble tungsten oxide hydrate (tungstic acid) precipitates. Various degrees of polymerization (isopolytungstates, metatungstates, paratungstates, etc.) are favored as the pH changes [60]. Other parameters influencing the polymerization include concentration, temperature, and time. Time plays an important role in reactions that proceed slowly. Thus, the properties of mildly acid or almost neutral solutions of tungsten change markedly after long periods of storage (a process often referred to as aging). Foreign ions also influence various polymerization reactions. Ammonium ions favor polymerization, even at higher pH values.

This is why  $(\text{NH}_4)_2\text{WO}_4$  cannot be crystallized from aqueous solution (it always forms APT), but only from tungstic acid and liquid ammonia. Anions such as phosphate, silicate, arsenate, etc., copolymerize with tungstates to form heteropolytungstates which usually have a higher degree of polymerization than the isopolytungstates stable at the same pH. Several isopolytungstates group around the central heteropolyanion.

Fluoride, sulfide, and peroxo anions have a depolymerizing effect, as these replace O atoms on the W [58]. The substitution of several O atoms by organic compounds with two or more donor atoms leads to the formation of numerous chelate complexes, and hence to depolymerization [58].

There are a number of compounds of tungsten with the elements Al, Be, Co, Ni, Fe, Zr, Hf, Ir, Os, Re, Ru, and Tc which can play a positive or negative role in the metallurgy of tungsten alloys. A comprehensive review of the literature on this subject can be found in [4].

### 26.7.2 Tungsten-Boron Compounds [4, 61]

The following compounds are known:  $\text{W}_2\text{B}$ ,  $\text{WB}$ ,  $\text{W}_3\text{B}_5$ , and  $\text{WB}_4$ . They are prepared by sintering the elements, from the oxides in an aluminothermic reaction, or by deposition from the gas phase. They are hard, brittle, crystalline, and electrically conducting, and are of no industrial importance.

### 26.7.3 Tungsten-Carbon Compounds [4]

There are three carbides (Table 26.4):  $\text{W}_2\text{C}$ ,  $\text{WC}$ , and the cubic high-temperature phase  $\alpha\text{-WC}_{1-x}$ .

Table 26.4: Physical properties of tungsten carbides.

	mp, °C	Crystal system	Density, g/cm <sup>3</sup>
$\text{W}_2\text{C}$	2770	hexagonal	17.2
$\text{WC}$	> 2600 (decomp.)	hexagonal	15.6
$\alpha\text{-WC}_{1-x}$	ca. 2750	cubic	

**Production.** The carbides are formed from tungsten or its compounds by reaction with carbon or carbon compounds. The most important industrial process is the reaction of tungsten metal powder with carbon black or graphite at 900–2200 °C. The reaction of  $\text{WO}_3$  with carbon is of less importance, as it is difficult to control the carbon balance.

**Industrial Importance.** WC is quantitatively the most important tungsten compound because of its hardness. It is also used as a reforming catalyst.

$\text{W}_2\text{C}$ , like WC, is present in the carbide melt used for "hard facing".

Mixed-crystal carbides such as  $\text{WC-TiC}$  (50:50) and  $\text{WC-TiC-Ta(Nb)C}$  (very variable composition) are widely used in hard metal production.

The  $\eta$ -carbides, of composition  $\text{Co}_6\text{W}_6\text{C}$  and  $\text{Co}_2\text{W}_4\text{C}$  to  $\text{Co}_3\text{W}_3\text{C}$ , and analogous compounds with Fe occur as intermediates in tungsten-containing steels and in special grades of hard metal.

**Tungsten Hexacarbonyl  $\text{W}(\text{CO})_6$**  [62]. This can be produced from  $\text{W} + \text{CO}$  or from  $\text{WCl}_6 + \text{CO} + \text{Al}$ . It is a white, crystalline substance that decomposes at 150 °C and is soluble in organic solvents, e.g.,  $\text{CCl}_4$ . It is used as a catalyst in organic syntheses.

### 26.7.4 Tungsten-Silicon Compounds [4, 61–63]

The following compounds are known:  $\text{WSi}_2$ ,  $\text{W}_5\text{Si}$ ,  $\text{W}_3\text{Si}_2$ ,  $\text{W}_2\text{Si}_3$ , and  $\text{W}_5\text{Si}_2$ . They are produced by heating the elements together. They are hard and stable to 900 °C. Tungsten silicide sputter targets are used in microelectronics to produce  $\text{WSi}_x$  films because of their exceptional characteristics and their thermal and chemical stability.

### 26.7.5 Tungsten-Nitrogen Compounds [62]

The following compounds are known:  $\text{W}_2\text{N}$  and  $\text{WN}$ . They are not formed by reaction of the elements, but by heating tungsten in am-

monia gas. They are of no industrial importance.

### 26.7.6 Tungsten-Phosphorus Compounds [4, 63]

The following compounds are known:  $WP_2$ ,  $WP$ ,  $W_2P$ . These can be synthesized from the elements. They are of no industrial importance.

### 26.7.7 Tungsten-Arsenic Compounds [4]

The following compounds are known:  $WAs_2$ ,  $W_2As_3$ . Synthesis is from the elements. They have no industrial importance.

### 26.7.8 Tungsten-Oxygen Compounds

**Oxides** [62, 64]. In the W-O system, there are not only the stoichiometric oxides  $WO_3$ ,  $WO_{2.9}$ ,  $WO_{2.72}$ ,  $WO_2$ , but also nonstoichiometric structures that represent the ordered or partially ordered defect structures of the oxygen-rich oxides, in which the central W atom is octahedrally surrounded by six oxygen atoms. In  $WO_3$ , neighboring octahedra are in contact only at the corners. With increasing oxygen deficiency (reduction, conversion to lower oxides), common edges and surfaces are progressively formed.

Tungsten trioxide,  $WO_3$ , is formed on strongly heating tungstic acid or APT in air. It is yellow, but even a small oxygen deficiency leads to greenish colorations. There are several crystallographic modifications which differ structurally from each other (variable distortion of the  $WO_6$  octahedra). Commercial  $WO_3$  (density  $7.29 \text{ g/cm}^3$ ) is monoclinic at room temperature. Heating to just below  $700^\circ\text{C}$  leads to orthorhombic  $WO_3$ , and above this temperature to the tetragonal form. It begins to vaporize appreciably below its melting point ( $1473^\circ\text{C}$ ). It is much more volatile in the presence of water vapor.  $WO_3$  is soluble in alkaline solutions and melts.

$WO_{2.9}$  ( $W_{20}O_{58}$ ) is bluish-violet, and occurs as an intermediate product during the reduction of  $WO_3$  with hydrogen. It can be prepared by the reduction of  $WO_3$  by moist hydrogen (e.g.,  $500\text{--}550^\circ\text{C}$ , water vapor pressure 60 kPa). It is a component of commercial blue oxide.

$WO_{2.72}$  ( $W_{18}O_{49}$ ) is reddish-violet, and above  $570^\circ\text{C}$  occurs as a characteristic needle-shaped intermediate product of  $WO_3$  reduction. It is prepared in the pure state by reducing  $WO_3$  with moist hydrogen (e.g.,  $800^\circ\text{C}$ , water vapor pressure 80 kPa). It can be present at low concentrations in industrial blue oxide.

Tungsten dioxide,  $WO_2$ , is chocolate brown in color, and is also an intermediate product of the reduction of tungsten compounds. It forms monoclinic crystals with a distorted rutile structure, and is therefore structurally very different from the higher oxides. The pure material is produced by reduction of  $WO_3$  with moist hydrogen (e.g.,  $900^\circ\text{C}$ , water vapor pressure 50 kPa).

$\beta$ -Tungsten,  $W_3O$ , [65, 66], is a gray or black substance produced at low reduction temperatures, usually during the reduction of doped tungsten oxides. It has a cubic  $A_{15}$  structure, and was first described as an allotropic modification of the metal, later as the suboxide  $W_3O$ . It is now thought that it is a metastable metallic phase stabilized by oxygen. It is stabilized by a series of other foreign elements, e.g., K, Be, P, B, As, and Al. It occurs as a characteristic intermediate product in the reduction of tungsten oxides doped with K, Al, and Si. Pure  $\beta$ -tungsten (by X-ray analysis) can be prepared by reduction of a thin layer of  $W_{20}O_{58}$  powder in dry hydrogen at  $500\text{--}600^\circ\text{C}$ .

**Oxide Hydrates.**  $WO_3 \cdot H_2O$  or  $WO_2(OH)_2$  [67] occurs as a monomeric gaseous compound during the industrial reduction of tungsten oxides with hydrogen at  $> 600^\circ\text{C}$ . It is formed by the reaction of the oxides with the water vapor formed during the reduction, and is the substance on which the chemical vapor transport of tungsten depends.

**Tungstic Acids** [4, 62, 68].  $H_2WO_4$  is formed when a hot alkali metal tungstate solution is acidified with a strong acid. It is a yellow powder, very sparingly soluble in water and acids, but very soluble in alkaline media.

White tungstic acid is obtained by precipitating in the cold and reversing the order of addition. It corresponds to the composition  $WO_3 \cdot xH_2O$ , where  $x \approx 2$ .

If tungstic acids are dried at  $< 300^\circ\text{C}$ , the orange-yellow hemihydrate  $2WO_3 \cdot H_2O$  is obtained.

Tungstic acid was formerly the most important high-purity intermediate product used in tungsten production, but has now been replaced by APT.

Tungstic acid in a highly pure form is today produced from APT by treatment with strong acids, and is used in the production of very fine tungsten powder and various tungsten-based chemicals.

**Tungstates** [4, 62, 69]. These are formed by most metal cations (e.g.,  $Na_2WO_4$ ,  $NiWO_4$ ,  $Cr_2WO_6$ ,  $ZrW_2O_8$ ). The structure of the tungstates is mainly determined by the size of the metal cation. Tungstates with large bivalent cations ( $\gg 0.1 \text{ nm}$ ) have the scheelite structure, and those with smaller ions ( $< 0.1 \text{ nm}$ ) the wolframite structure. Apart from the alkali metal and magnesium tungstates, these are all sparingly soluble in water. All the most important ores are tungstates.

Sodium tungstate crystallizes with two molecules of water of crystallization. Aqueous solutions are used as heavy liquids, in fuel cells, for flame-resistant and antistatic textiles, in cigarette filters, and as corrosion inhibitors for steel. Anhydrous sodium tungstate is obtained by melting  $WO_3$  with sodium hydroxide or carbonate.

Calcium tungstate fluoresces under ultraviolet light, a phenomenon which is utilized when prospecting for scheelite deposits. Calcium tungstate is used in the production of phosphors for lasers, fluorescent lamps, oscilloscopes, luminescent dyes, scintillation counters, X-ray screens, etc.

A wide range of tungstates are used in the ceramic industry, in catalysts, and in pigments.

**Polytungstates.** The tendency of tungstate ions to polymerize in aqueous solution has already been referred to. The degree of polymerization increases with decreasing pH until tungstic acid is precipitated at pH 1. Other anions, e.g., arsenate, phosphate, silicate, can be incorporated into these highly polymeric ions. According to whether the polyanions are composed only of tungstate or also include foreign ions, they are referred to as isopolytungstates or heteropolytungstates.

Isopolytungstates can have various preferred degrees of polymerization, as mentioned above [60]. The most industrially important compound in this class is APT, the most widely used high-purity raw material in the tungsten industry.

Ammonium metatungstate is produced either with the aid of ion exchangers or by electro dialysis, and, owing to its high solubility in water, is used for impregnating carriers (e.g., aluminum oxide) in the production of catalysts.

Sodium metatungstate is used as a heavy liquid when drilling for oil.

**Amine Tungstates** [60, 70, 71]. Organic amines form water-insoluble ion associate complexes with isopolytungstates. Complex long-chain amines ( $C_8\text{--}C_{10}$ ) are used as reagents in the industrial solvent extraction of tungsten. Complexes with short-chain amines (ethylenediamine, propylamine, etc.) show autoreductive and autocarburizing properties on heating. This is of interest for the production of finely powdered W or WC, which can be obtained from the precursor in a single-step process.

**Heteropolytungstates.** There are over 30 elements known to form the central anion in these compounds. Typical properties independent of the central heteroatom include high relative molecular mass ( $> 3000$ ), high degree of hydration, and high solubility in water and organic solvents. A summary of possible

structures and compositions can be found in [62].

One of the most industrially important compounds in this group is  $\text{Na}_3\text{PW}_{12}\text{O}_{40} \cdot x\text{H}_2\text{O}$  [72, 73]. This has many uses: for fixing and oxidizing in photographic processes; as an additive in electroplating; for waterproofing plastics, adhesives, and cement; in the production of organic pigments; for the surface treatment of skins; as an antistatic agent for textiles; for printing and paper dyes; for coatings; wax pigments; steel passivation; and as a catalyst in the organic chemical industry.

**Tungsten Bronzes** [4, 62, 69]. These are well-defined though nonstoichiometric compounds with the general formula  $\text{M}_x\text{WO}_3$ , in which  $x$  is between 0 and 1;  $M$  represents a metal cation,  $\text{H}^+$ , or  $\text{NH}_4^+$ . The name is derived from the metallic luster and intense colors (golden yellow to blue-black) of these compounds. The bronze character is determined by the amount of metal in the structure. With high values of  $x$ , interaction between the metal ions leads to the formation of metallic bonds. The stability of the bronzes is determined by the size of the metal ions. Stability decreases as the ionic radius decreases. Small metal ions, e.g., Si and Ge, do not form bronzes. Owing to the oxygen deficit, these compounds are electrical semiconductors or conductors. The sodium bronzes for which the  $\text{Na}/\text{WO}_3$  ratio is  $> 0.3$  have a positive temperature-resistance coefficient, and vice versa.

The bronzes are produced:

- By partial reduction of the corresponding tungstates
- By electrolytic reduction
- By the reaction in the fused or solid state of  $\text{WO}_3$ - $\text{WO}_2$  mixtures with metal compounds

Tungsten bronzes are used as colored pigments, catalysts, e.g., for the oxidation of CO, and in fuel cells. Electrodes made of  $\text{La}_x\text{WO}_3$  are used in sensors for the potentiometric determination of dissolved oxygen.

Hydrogen and alkali metal bronzes are used as electrochromic coatings for so-called dynamic glasses. Application of an electrical potential causes migration of the ions ( $\text{H}^+$ ,  $\text{Na}^+$ )

into or out of the coating, thereby changing the properties of the glass from transparent (oxidic) to reflecting (metallic due to bronze formation). The only practical application of this so far is in electrochromic sunglasses.

### 26.7.9 Tungsten-Chalcogenide Compounds

**Tungsten-Sulfur Compounds** [4, 62, 74, 75]. The following compounds are known:  $\text{WS}_2$ ,  $\text{WS}_3$ . Tungsten disulfide is of industrial importance. It is black, forms hexagonal or rhombic crystals, and can be synthesized from the elements. It is used as a catalyst for the desulfurization of mineral oil, and as an oil-soluble lubricant under extreme conditions (pressure, temperature, vacuum).

**Tungsten-Selenium Compounds** [4, 75]. The following compounds are known:  $\text{WSe}_2$ ,  $\text{WSe}_3$ . The diselenide can be synthesized from the elements, and is used as an oil-soluble lubricant.

**Tungsten-Tellurium Compounds** [4].  $\text{WTe}_2$  is known, but is of no industrial importance.

### 26.7.10 Tungsten-Halogenide Compounds

**Tungsten-Fluorine Compounds** [4, 62]. The following compounds are known:  $\text{WF}_6$ ,  $\text{WF}_5$ ,  $\text{WF}_4$ ,  $\text{WOF}_4$ ,  $\text{WO}_2\text{F}_2$ ,  $\text{WOF}_2$ . Only the hexafluoride is of industrial importance, being used to produce CVD tungsten. It can be produced by the reaction of tungsten hexachloride with hydrogen fluoride, or by direct combination of the elements at 350–400 °C. The boiling point is 17.5 °C. The colorless gas is soluble in organic solvents, and is sensitive to moisture (hydrolysis).

**Tungsten-Chlorine Compounds** [4, 62]. The following compounds are known:  $\text{WCl}_6$ ,  $\text{WCl}_5$ ,  $\text{WCl}_4$ ,  $\text{WCl}_2$ ,  $\text{WOCl}_4$ ,  $\text{WO}_2\text{Cl}_2$ ,  $\text{WOCl}_3$ ,  $\text{WOCl}_2$ . Two of these are of industrial importance:

*Tungsten hexachloride* is a crystalline blue-black compound ( $mp$  275 °C,  $bp$  346 °C). It is

obtained by direct combination of the elements at 600 °C. It is soluble in carbon disulfide and organic solvents, and is hydrolyzed by water. It has a wide range of uses in catalysis.

*Tungsten oxytetrachloride* forms red crystals ( $mp$  211 °C,  $bp$  327 °C), and is soluble in carbon disulfide and benzene. It is produced by the reaction of sulfur chloride with  $\text{WO}_3$ . It too has a wide range of uses in catalysis.

**Tungsten-Bromine Compounds** [4, 62]. The known compounds, which are of no industrial importance, are:  $\text{WBr}_6$ ,  $\text{WBr}_5$ ,  $\text{WBr}_4$ ,  $\text{WBr}_3$ ,  $\text{WOBr}_4$ ,  $\text{WO}_2\text{Br}_2$ ,  $\text{WOBBr}_2$ ,  $\text{WOBBr}_3$ .

**Tungsten-Iodine Compounds** [4, 62]. The known compounds, which are of no industrial importance, are:  $\text{WI}_6$ ,  $\text{WI}_5$ ,  $\text{WI}_2$ ,  $\text{WO}_2\text{I}_2$ ,  $\text{WOI}_2$ ,  $\text{WO}_2\text{I}$ ,  $\text{WOI}_4$ .

## 26.8 Tungsten in Catalysis [57, 76–78]

Tungsten, both in metallic form and in a wide range of compounds, is used as a catalyst or catalyst component in a large number of chemical processes.

In the form of a metallic alloy with Ni, Co, or Rh, sometimes in the form of a sulfide, and sometimes on aluminum oxide carriers, it can catalyze the reaction of CO with  $\text{H}_2$ , and also hydrotreating, hydrocracking, reforming, and hydrodesulfurization reactions.

The following oxides are used as catalysts:

$\text{WO}_3$  is used in colloidal form for the photocatalytic reduction of organic compounds.

$\text{W}_{20}\text{O}_{58}$  catalyzes hydrogenation, dehydrogenation, hydroxylation, epoxidation, etc.

Mixed oxides of  $\text{WO}_3$  with  $\text{TiO}_2$  and/or  $\text{V}_2\text{O}_5$ ,  $\text{Al}_2\text{O}_3$ , or  $\text{SiO}_2$  have a wide range of uses, e.g., as DENOX catalysts for exhaust gas cleaning in thermal power stations, hydrogenation, aldol condensation, ring opening reactions, dimethyl sulfoxide synthesis, etc.

Of the halides, the compounds  $\text{WCl}_6$  and  $\text{WOCl}_4$  play a very important role in organic chemistry as catalyst components, e.g., in association with organometallic compounds such as  $\text{AlCl}_2(\text{C}_2\text{H}_5)_2$ ,  $\text{Sn}(\text{C}_6\text{H}_5)_4$ ,  $\text{Sn}(\text{CH}_3)_4$ ,

$\text{Sn}(\text{C}_4\text{H}_9)_4$ , triaryl- or trialkyltin hydroxides, or the analogous lead compounds. Typical uses include: diene polymerizations, ring opening polymerizations, alkylations, etc.

WC is used for reforming *n*-heptane, as a redox catalyst for the oxidation of hydrogen in fuel cells, and for the formation of hydrogen from water.

$\text{W}(\text{CO})_6$  catalyzes a wide range of organic reactions, e.g., the metathesis of alkenes.

Sodium tungsten bronze catalyzes the oxidation of CO.

The sodium salt of 12-tungstophosphoric acid is used as a catalyst for isomerization, polymerization, nitrile synthesis, dehydrochlorination, dehydrogenation, ketone syntheses, and ring closure syntheses.

$\text{WS}_2$  and  $\text{WSe}_2$  in the form of colloidal coatings have been tested for photocatalysis.

## 26.9 Economic Aspects [79]

The price of tungsten in ore concentrate depends on supply and demand, and is therefore subject to fluctuations (Figure 26.7). It is expressed either as \$/STU (short ton unit = 20 lb  $\text{WO}_3$  = 7.19 kg W) or in \$/MTU (metric ton unit = 10 kg  $\text{WO}_3$  = 7.93 kg W). In times of warlike confrontation, the strategic importance and consequently increased demand for tungsten have led to high prices. On average, prices increased until 1977, although this was partly caused by inflation. The price maximum reached in 1977 was a consequence of increased consumption. Hand in hand with this development, the mining of tungsten shifted from the developing countries to the highly industrialized countries. This was mainly to secure supplies in times of crisis. In 1970, 49% of tungsten came from western industrialized countries. In 1980, this figure was 58%, and 69% was predicted for 1990. However, this figure was never reached, as the market share of China had continuously increased (Figure 26.8).

In 1977, world tungsten demand was still < 40 000 t. As shown in Figure 26.8, demand continued to increase until 1989, reaching ca. 52 000 t, but the price fell from 1977 onward.

Thus, the price control mechanism that had been operating well until then was obviously no longer effective.

Several circumstances were responsible for this:

Up to 1977, China, for long the most important exporter of tungsten ore concentrates, had been price conscious in its trading, as this was only carried out by state officials. Following the liberalization of trading in China, producers attempted to obtain foreign currency directly by quoting low prices. Internal competition and pressure from dealers led to continued price reductions.

This fall in prices was exacerbated by the fact that high-purity intermediate products, e.g., APT, blue tungsten oxide, tungstic acid, and ferrotungsten, were offered at the same price per unit of tungsten as ore concentrates. At the end of 1993, the price of high-purity APT was so low that even the Chinese producers were no longer able to sell at a profit.

The drastic fall in demand that started in 1990 and which was caused by the general recession, the breakdown of the communist world, and the associated decline in the armaments industry led to stabilization of the lower prices.

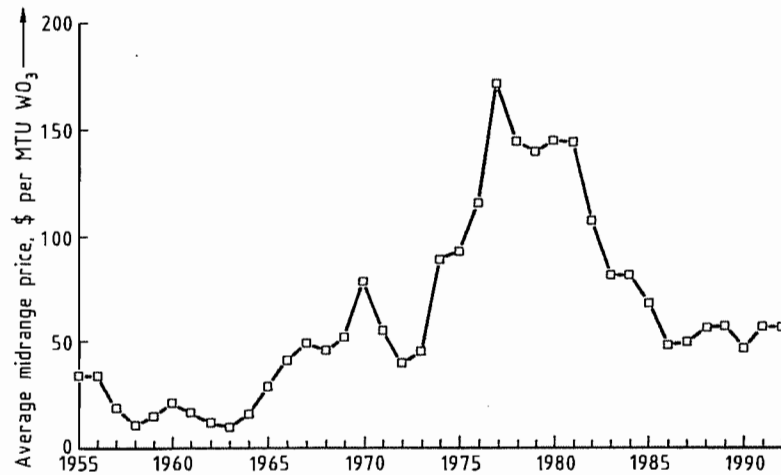

Figure 26.7: Average mid-range price of wolframite 1955–1992 (from *Metall Bulletin*).

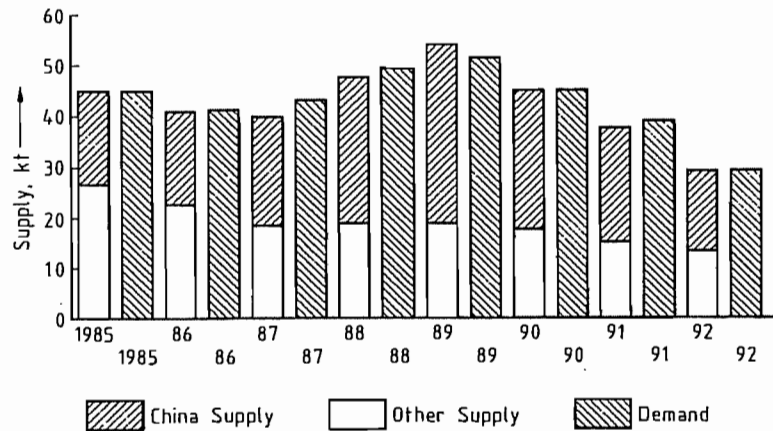

Figure 26.8: Tungsten supply and demand 1985–1992.

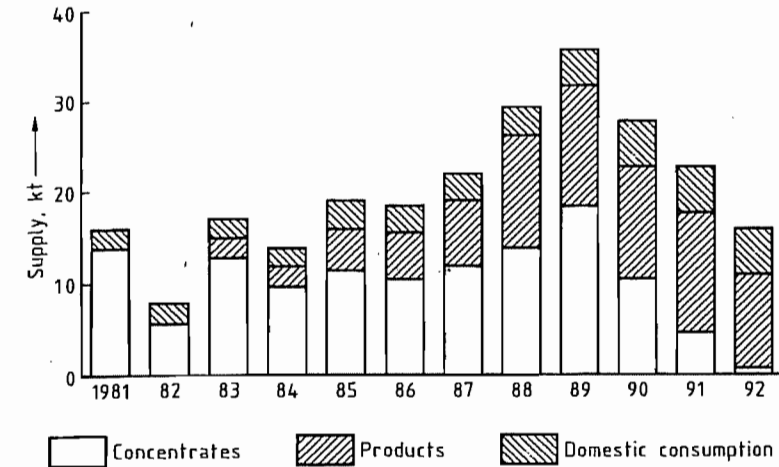

Figure 26.9: Tungsten supply in China 1981–1992.

Quite simply, the low tungsten price and the fact that there was no price difference between ore concentrate and intermediate product led to the enforced closure of almost all the larger mines in North America, Europe, South Korea, and Australia, and the suspension of many associated industries based on the treatment of ore concentrates.

In consequence, not only has the proportion of tungsten supplied from China increased (Figure 26.8), but also the makeup of the products has changed (Figure 26.9). Whereas China was still an exporter exclusively of tungsten ore concentrate in the early 1980s, today it is the largest supplier of high-purity tungsten intermediate products.

Thus, none of the predictions, e.g., 4% annual growth, opening of new mines, further shifting of mine production to the industrialized countries, self-sufficiency, etc., has been fulfilled. World demand for tungsten has decreased drastically; China is the main supplier.

### 26.10 Tungsten Recycling

As stated in Section 26.3, large amounts of tungsten scrap have been used as a raw material for several decades. This is because of:

- The value of the tungsten content

- The value of other metals in the alloys, e.g., Ta and Co in hard metals and Ni in heavy metals
- Environmental aspects
- Economic aspects

Methods for the treatment of scrap and utilization of the recovered materials are optimized where possible in the light of these factors.

Both direct and indirect recycling processes are used. In direct recycling, scrap is converted from the compact form to a powder which is then recycled only to the process that produced the material from which the scrap originated. For this, the scrap must consist of one grade only, and must not contain heterogeneous impurities.

In the indirect process, scrap is chemically converted to materials from which the impurities and other components are removed, and is then converted to APT as described in Section 26.4.

The direct method is preferable for economic and environmental reasons, but it can be used only for certain types of scrap, and the demand for the recycled product is not always certain. For this reason, the proportion of scrap tungsten treated by conversion to APT is continually increasing.

**Table 26.5:** Tungsten recycling (B = best; G = good; L = least economic use) [13, 14].

Treatment	Hard metal scrap	Heavy metal		W-Cu	W-Ag	Pure tungsten
		Hard	Soft			
Zinc process	B					
Coldstream	B		G			L
Bloating/crushing	B					
Oxidation/reduction			B			L
Hydrometallurgy		L	L	B	B	L
Electrolytic		L	L	B	G	L
Chlorination	L	L	L	L	L	L
Melting (ferrotungsten, stellite)	G	G	G			G

Combined processes are also used, e.g., the selective separation and recovery of one alloying component. Examples include the leach milling of hard metal scrap to liberate the cobalt binder metal, leaving behind the carbide phase(s), which can be recycled to the hard metal production process.

A proportion of tungsten scrap goes to smelting metallurgy for the production of stellites, melting base alloys, menstruum WC, and steel.

The economics of various treatment processes for the important types of scrap are compared in Table 26.5.

## 26.11 Beneficial Effects on Human Health [80, 81]

In contrast to certain toxic effects of metallic tungsten and its compounds and alloys, some very beneficial effects on human health have recently been described. An aqueous solution of sodium tungstate (ca. 2%) was taken orally, applied to the skin, used as a gargle or an eye lotion, or injected subcutaneously. Experiments on 100 people in Japan showed remarkably successful results with a wide range of illnesses, e.g., cataract, stomach ulcers, duodenal ulcers, cancer, diabetes, herpes, migraine, gout, cardiac arrhythmia, and many others. Tungstate is also beneficial in cases of mercury or selenium poisoning, burns, and sunburn, and it can counteract the unpleasant aftereffects of excessive alcohol consumption, as is also reported for molybdate. It has furthermore been established that the natural aging process is significantly retarded. It is to be hoped that funded scientific investigations

into the action of tungstate will be undertaken as soon as possible.

## 26.12 Toxicology and Occupational Health

Tungsten and most of its compounds generally show relatively low toxicity compared to most other heavy metals and their compounds. However, some tungsten compounds are more toxic than they were originally considered to be.

Intoxications with tungsten and its compounds are comparatively rare; they occur almost exclusively by occupational exposure.

Physiological responses, toxicokinetics, toxic effects, levels of tolerance, and ecotoxicity of tungsten and its compounds have been reviewed [82–84].

**Toxicokinetics.** In animal models, nearly one-half of ingested soluble tungsten compounds and roughly one-third of deposited inhaled tungsten trioxide aerosol is readily absorbed. Most of the absorbed tungsten is rapidly excreted in the urine. The remainder is distributed among the red blood cells, spleen, kidney, and bone. About 3 months after ingestion and 6 months after inhalation, most of the complete tungsten body burden has been transferred into bone. However, this amount is very small as compared to the administered dose [83]. The biological half-life of tungsten in bone is calculated at 1100 d for the slowest component of a three-component elimination kinetics [85].

Tungsten seems to have an influence on molybdenum homeostasis. In rats, the addi-

tion of 100 ppm tungsten to a diet containing 30 ppm molybdenum caused a decrease in the activities of sulfite oxidase and xanthine oxidase, which led to a significant increase in the susceptibility of these animals to sulfur dioxide [86].

**Acute Toxicity.** Acute intoxications are caused especially by tungsten hexafluoride,  $WF_6$ . Liquid or gaseous  $WF_6$  reacts readily with water, generating highly toxic hydrogen fluoride. Consequently, the mucous membranes of the respiratory tract and the eyes are damaged severely after contact with  $WF_6$ . Acute intoxication causes a strong irritation of the upper respiratory tract, laryngitis, and bronchitis; after a period of less severe symptoms the development of cyanosis and lung edema is possible [87].

In contrast, 25–80 g of powdered tungsten metal did not cause adverse effects when administered orally as a substitute for barium sulfate in radiological examinations [88].

**Chronic Toxicity.** Cemented tungsten carbide, WC, is suspected of causing respiratory diseases in humans. However, these effects are possibly not due to WC itself, but rather to its content of cobalt metal. In workers processing WC the development of interstitial pulmonary fibrosis has been reported [89, 90]; the clinical picture includes cough, exertional dyspnea, and weight loss. Abnormal gas transfer was detected in respiratory function tests.

In the case of a 33-year-old woman who was exposed to cemented WC for several years and who died after development of pneumoconiosis, an increased content of cobalt ions in bones and lung was demonstrated after autopsy [91]. In various test series with rats there were strong indications that cobalt was the main reason for the development of the lung diseases [92].

In long-term studies with rats and mice, 5 ppm tungsten (as sodium tungstate) was added to the drinking water during the life span of the test animals. In rats, growth development increased slightly, whereas the life span decreased significantly [93]. Mice did not show these effects [94].

**Genotoxicity.** In a long-term study with mice, in which 5 ppm tungsten (as sodium tungstate) was added to the drinking water during their life span, no tumorigenic effect was seen [94].

**Reproductive Toxicity.** In rats, tungsten causes an increased embryo lethality and decreased ossification of bones in a dose range with no toxic effects to the maternal organism [95]. Tungsten accumulates in the fetus without being retained significantly by the placenta.

In another study on the embryonic and fetal development in mice [96], tungsten was injected as sodium tungstate before implantation or at early organogenesis (on day 3 or 8 of pregnancy, injection of 0.1 mL of 25 mmol/L sodium tungstate). The treatment did not show any effect on implantation, but increased the frequency of resorption.

**Immunotoxicity.** In a patch test, no allergic reactions to  $Na_2WO_4$  were seen on the skin of 853 hard-metal workers [97]. However, irritant pustular reactions appeared in 2% of the test persons.

**Toxicological Data.** Tungsten:  $LD_{50}$  (rat, i.p.) 5000 mg/kg [98]; sodium tungstate,  $Na_2WO_4$  (rat, s.c.) 223–255 mg/kg [99]; phosphotungstic acid,  $H_3P(W_3O_{10})_4$ :  $LD_{50}$  (rat, oral) 3300 mg/kg [100]; tungsten carbide, WC (containing 8% cobalt):  $LDLo$  (rat, intratracheal) 75 mg/kg [101]; tungsten carbide, WC (containing 15% cobalt):  $LDLo$  (rat, intratracheal) 50 mg/kg [101].

In humans normal mean blood levels are considered to be  $5.8 (\pm 3.5) \mu\text{g W/L}$  [82].

**Treatment.** Dimercaprol (British Anti-Lewisite) may be useful in the treatment of acute tungsten poisoning [102]. Cortisone preparations have been proposed for decreasing the development of lung fibrosis [103].

**Occupational Health.** The MAK value is  $1 \text{ mg/m}^3$  for tungsten and soluble tungsten compounds, and  $5 \text{ mg/m}^3$  for tungsten carbide and other insoluble tungsten compounds, measured as total dust [104]. In the United States, NIOSH has set exposure limits (TLV-TWA)

of 1 mg/m<sup>3</sup> for soluble and 5 mg/m<sup>3</sup> for insoluble tungsten compounds [105].

Lung fibrosis caused by tungsten or tungsten carbide is included in the list of the German Berufskrankheitenverordnung (Occupation Disease Regulations) [106].

Since tungsten tends to accumulate, persons exposed at the workplace should undergo periodical medical checks including chest X rays and ventilatory function tests for insoluble tungsten compounds, as well as examinations of the digestive tract and the central nervous system for soluble tungsten compounds [107].

## 26.13 References

- R. Kieffer, G. Jangg, P. Etmayer: *Sondermetalle*, Springer Verlag, Wien-New York 1971.
- A. G. Quarrell (ed.): *Niobium, Tantalum, Molybdenum and Tungsten*, Elsevier, Amsterdam 1971.
- Metallwerk Plansee, Wolfram, company brochure, Reutte, Austria, 1980.
- S. W. H. Yih, C. T. Wang: *Tungsten: Sources, Metallurgy, Properties and Applications*, Plenum Press, New York-London 1979.
- Gmelin, system no. 54, Suppl. vol. A1.
- Gmelin, system no. 54, part B2; part B3; part B4.
- Ullmann, 4th ed., 24, 457.
- B. Aronsson: "Some Notes about the History of Tungsten and Scheelite", booklet printed by AB Sandvik Coromant, R & D Materials and Processing Library, Stockholm 1978.
- R. Eck, E. Lugscheider: "Molybdän, Wolfram und ihre Legierungen", Lecture on Sondermetalle at Technischen Akademie Esslingen, Esslingen 1980.
- E. Fromm, E. Gebhardt: *Gase und Kohlenstoff in Metallen*, Springer Verlag, Berlin-Heidelberg-New York 1976.
- Roskill Information Services: *The Economics of Tungsten*, London, Feb. 1990.
- R. F. Stevens, Jr., *Bull. U.S. Bur. Mines* 667 (1975) 1161.
- B. F. Kieffer, E. F. Baroch in H. Y. Sohn, O. N. Carlson, J. T. Smith (eds.): "Extractive Metallurgy of Refractory Metals", *Proc. TMS-AIME Annu. Meeting*, 1981, 273.
- B. F. Kieffer, E. Lassner, *Tungsten Proc. Int. Tungsten Symp. 4th*, 1987, 59.
- E. Lassner in H. Y. Sohn, O. N. Carlson, J. T. Smith (eds.): "Extractive Metallurgy of Refractory Metals", *Proc. TMS-AIME Annu. Meeting*, 1981, 269.
- AMAX, US 4338287, 1983 (R. F. Hogsett, D. K. Huggins, L. B. Beckstead).
- E. Lassner, B. F. Kieffer, *Conf. Proc. Adv. in Hard Materials Production*, London 1988, Contr. 5.
- GTE Prod., US 4353878, 1982 (L. R. Quatrini, M. B. Terlizzi, B. E. Martin).
- Engelhard Minerals and Chem., US 4092400, 1978 (V. Zbrank, D. A. Burnham).
- AMAX, US 4320096, 1982 (P. B. Queneau, D. K. Huggins, L. W. Beckstead).
- E. Lassner, *Österr. Chem. Ztg.* 80 (1979) 111.
- AMAX, US 4311679, 1982 (P. B. Queneau, L. W. Beckstead, D. K. Huggins).
- M. B. Macinnis, T. K. Kim, *Int. J. Refr. Hard Met.* 5 (1986) 78.
- T. Zuo, Q. Zhao, S. Li, J. Wang, *Proc. 1st Int. Conf. Metall. Sci. W, Ti, Re and Sb* 1 (1988) 11.
- J. Zhou, J. Xue, *Proc. 5th Int. Tungsten Symp.*, Budapest 1990, pp. 73-86.
- E. Lassner in B. Lux, L. Bartha, E. Lassner, W. D. Schubert (eds.): *Chemistry of Doped Non Sag Tungsten* (in press).
- J. W. van Put, T. W. Zegers, A. van Sandwijk, P. J. M. van der Straten in C. S. Baird, C. Vijayan (eds.): *Proc. 2nd Int. Conf. Separation Sci. Technol.*, Hamilton, Canada, 1989, p. 387.
- J. W. van Put, D. M. de Konig, A. van Sandwijk, G. J. Witkamp in GVC.VDI/E.F.C.A. Mersman (ed.): *Proc. 11th Symp. Ind. Crystallization*, Garmisch Partenkirchen 1990, p. 647.
- R. Haubner et al., *Int. J. Refr. Hard Met.* 2 (1983) 108, 156.
- W. D. Schubert, *Int. J. Refr. Met. Hard Mat.* 9 (1991) 178.
- W. D. Schubert, E. Lassner, *Int. J. Refr. Met. Hard Mat.* 10 (1991) 133, 171.
- R. Haubner, W. D. Schubert, B. Lux, E. Lassner in H. M. Ortner (ed.): *Proc. 11th Plansee-Seminar* 2 (1985) 69.
- F. Benesovsky (ed.): *Pulvermetallurgie und Sinterwerkstoffe*, 3rd ed., Metallwerk Plansee GmbH, Reutte, Austria, 1982.
- W. Schintelmeyer, O. Pacher, K. Kailer, W. Wallgram in H. M. Ortner (ed.): *Proc. 10th Plansee-Seminar* 2 (1981) 635.
- Y. M. Korolev, V. A. Sorkin in H. Bildstein, H. M. Ortner (eds.): *Proc. 12th Plansee-Seminar* 1 (1989) 247.
- J. P. Wittenauer, T. G. Niemi, J. Wadsworth, *Adv. Mater. Process.* 9 (1992) 28.
- H. S. Yu et al., *Int. J. Refr. Met. Hard Mat.* 11 (1992) 317.
- R. Huenert, G. Winter, W. Kiliani, D. Greifendorf, *Int. J. Refr. Met. Hard Mat.* 11 (1992) 331.
- V. G. Glebovsky in H. Bildstein, H. M. Ortner (eds.): *Proc. 12th Plansee-Seminar* 3 (1989) 379.
- O. Grau: "Sampling in the Non-Ferrous Industry", in G. Kraft (ed.): *Series of Bulk Material Handling*, vol. 6, Trans Tech Publ., Clausthal-Zellerfeld 1993, p. 131.
- Gesellschaft deutscher Metallhütten- und Bergleute e.V. (eds.): *Analyse der Metalle*, Suppl. vol. 1, Springer Verlag, Berlin-Heidelberg-New York 1980, p. 213.
- V. Scherer, D. Hirschfeld, *Erzmetall* 39 (1986) 251.
- Gesellschaft Deutscher Metallhütten- und Bergleute e.V. (eds.): *Analyse der Metalle*, Suppl. vol. 1, Springer Verlag, Berlin-Heidelberg-New York 1980, p. 229.
- H. M. Ortner, *Talanta* 26 (1979) 629.
- D. Hirschfeld, H. M. Ortner, *Metall (Berlin)* 35 (1981) 434.
- C. Vandecasteele, K. Strijckmans, C. Engelmann, H. M. Ortner, *Talanta* 28 (1981) 19.
- H. M. Ortner in O. van der Biest (ed.): *Analysis of High Temperature Materials*, Applied Science Publ., London-New York 1983.
- H. M. Ortner, *Erzmetall* 35 (1982) 555, 612.
- E. Lassner, F. Benesovsky, *Mikrochim. Acta Suppl.* 5 (1974) 291.
- H. M. Ortner, *Erzmetall* 32 (1979) 507.
- E. Lassner, H. Petter, *Mikrochim. Acta Suppl.* 6 (1975) 133.
- V. Scherer in H. M. Ortner (ed.): *Proc. 10th Plansee-Seminar* 2 (1981) 269.
- W. D. Schubert, E. Lassner, *Int. J. Refr. Met. Hard Mat.* 10 (1991) 133.
- P. Wilhartz, H. M. Ortner, R. Krismer in H. Bildstein, H. M. Ortner (eds.): *Proc. 12th Plansee-Seminar* 3 (1989) 575.
- K. G. Heumann, P. Herzer, H. E. Gabler in H. Bildstein, H. M. Ortner (eds.): *Proc. 12th Plansee-Seminar* 4 (1989) 191.
- Treibacher Chemische Werke, Lieferprogramm Wolfram-Melting Base, Treibach 1991.
- Gesellschaft für Elektrometallurgie, Lieferprogramm, Nürnberg 1989.
- R. Püschel, E. Lassner: "Chelates and Chelating Agents in the Analytical Chemistry of Mo and W", in H. Flaschka, A. J. Barnard (eds.): *Chelates in Analytical Chemistry*, Marcel Dekker, New York 1967.
- K. H. Tytko, O. Glemser, *Adv. Inorg. Chem. Radiochem.* 19 (1976) 239.
- T. K. Kim, R. W. Mooney, V. Chiola, *Sep. Sci.* 3 (1968) 467.
- H. J. Goldschmidt: *Interstitial Alloys*, Plenum Publ., New York 1967.
- Kirk-Othmer*, 23, 426-438.
- W. B. Pearson: *Handbook of Lattice Spacings and Structure of Metals*, Pergamon Press, New York 1967.
- J. Booth, T. Eckström, E. Iguchi, R. J. D. Tilley, *J. Solid State Chem.* 41 (1982) 293.
- A. J. Hegedüs, T. Millner, J. Neugebauer, *Z. Anorg. Allg. Chem.* 281 (1955) 64-82.
- W. R. Morcom, W. L. Worrell, H. G. Sell, *Met. Trans.* (1974) 155-161.
- O. Glemser, H. Ackermann, *Z. Anorg. Allg. Chem.* 325 (1963) 281-286.
- G. Yidong, *Proc. 1st Int. Conf. Metall. Mat. Sci. W, Ti, Re and Sb*, 1 (1988) 213.
- T. Eckström, R. J. D. Tilley, *Chem. Sci.* 16 (1980) 1.
- GTE Sylvania, US 4175109, 1979 (T. K. Kim).
- Tang Xinhe, Ph.D. Thesis, Technical University Vienna 1994.
- Sylvania, Technical Information Bull. CM-9003, no. 9, Towanda, PA, 1980.
- Misono Makato: "Catalysis Review", *Sci. Eng.* 29 (1987) 269.
- J. C. Wildervanck, F. Jelinek, *Z. Anorg. Chem.* 328 (1964) 309.
- O. Glemser, H. Sauer, B. König, *Z. Anorg. Allg. Chem.* 257 (1948) 241.
- J. Desilvestro, M. Neumann-Spallart, *J. Phys. Chem.* 89 (1985) 3684.
- I. Bedja, S. Hotchandani, P. Kamat, *J. Phys. Chem.* 97 (1993) 11064.
- M. Neumann-Spallart, *Hydrogen Energy Prog. VI* 12 (1986) 577.
- International Tungsten Industry Association (eds.): *Newsletter*, 280 Earls Court Road, London SW5 9AS, June 1993.
- K. Kase: *Tungsten Sui Soda*, Tokyo 1991.
- E. Lassner, W. Aschenbrenner, *Proceedings of the 6th Tungsten Symposium*, Guangzhou 1993.
- H. E. Stokinger in G. D. Clayton, F. E. Clayton (eds.): *Patty's Industrial Hygiene and Toxicology*, 3rd ed., Wiley-Interscience, New York 1981, pp. 1981-1995.
- G. Kazantzis in L. Friberg, G. F. Nordberg, V. Vouk (eds.): *Handbook on the Toxicology of Metals*, 2nd ed., Elsevier Science Publisher, Amsterdam 1986, pp. 610-622.
- R. Wennig, N. Kirsch in H. G. Seiler, H. Sigel, A. Sigel (eds.): *Handbook on Toxicity of Inorganic Compounds*, Marcel Dekker, New York 1988, pp. 731-738.
- S. V. Kaye, *Health Phys.* 15 (1968) 398-417.
- H. J. Cohen, R. T. Drews, J. L. Johnson, K. V. Rajagopalan, *Proc. Natl. Sci. USA* 70 (1973) 3655-3659.
- R. Kühn, K. Birett: *Merkblätter gefährliche Arbeitsstoffe*, 4th ed., ecomed Verlag, Landsberg/Lech, Datenblatt W-004.
- R. Krüger, *Muench. Med. Wochenschr.* 35 (1912) 1910.
- E. O. Coates, J. H. L. Watson, *Ann. Intern. Med.* 75 (1971) 709-716.
- N. L. Sprince, R. I. Chabern, C. A. Hales, A. L. Weber, H. Kazemi, *Chest* 86 (1984) 549-557.
- H. Kitamura, *Yokohama Med. Bull.* 31 (1980) 103-126.
- H. Kitamura, Y. Yoshimuro, I. Tozawa, K. Koshi, *Acta Pathol. Jpn.* 30 (1980) 241-254.
- H. A. Schroeder, M. Mitchener, *J. Nutr.* 105 (1975) 421-427.
- H. A. Schroeder, M. Mitchener, *J. Nutr.* 105 (1975) 452-458.
- V. G. Nadeenko, V. G. Lenchenko, S. B. Genkina, T. A. Arkhipenko, *Farmakol. Toksikol. (Moscow)* 41 (1978) 620-623.
- M. Wide, *Environm. Res.* 33 (1984) 47-53.
- I. Rystedt, T. Fischer, B. Lagerholm, *Contact Dermatitis* 9 (1983) 69-73.
- American Conference of Governmental Industrial Hygienists (eds.): *Documentation of Threshold Limit Values for Substances in Workroom Air*, Cincinnati, OH, 1980, p. 273.
- F. W. Kinard, J. van de Erve, *Am. J. Med. Sci.* 199 (1940) 668-670.
- E. H. Vernot, J. D. MacEwen, C. C. Haun, E. R. Kinkead, *Toxicol. Appl. Pharmacol.* 42 (1977) 417-423.
- National Technical Information Service, AEC-TR-6710. English translation of Z. E. Izraelson: *Toxicology of the Rare Metals*, Moscow 1963.
- M. J. Ellenhorn, D. G. Barceloux: *Medical Toxicology: Diagnosis and Treatment of Human Poisoning*, Elsevier, New York 1988, p. 77.
- S. Moeschlin: *Klinik und Therapie der Vergiftungen*, 7th ed., Georg Thieme, Stuttgart 1986, p. 201.

104. Deutsche Forschungsgemeinschaft (ed.): *MAK- und BAT-Werte-Liste 1993*, Maximale Arbeitsplatzkonzentrationen und Biologische Arbeitsstofftoleranzwerte, Mitteilungen der Senatskommission zur Prüfung gesundheitsschädlicher Arbeitsstoffe, Mitteilung 29, VCH Verlagsgesellschaft, Weinheim 1993.
105. American Conference of Governmental Industrial Hygienists (eds.): *Threshold Limit Values (TLV) 1982*, Cincinnati, OH, 1982.
106. Berufskrankheitenverordnung, BK Nr. 4107: Erkrankungen durch Lungenfibrose durch Metallstäube bei der Herstellung oder Verarbeitung von Hartmetallen.
107. R. Roi, W. G. Town, W. G. Hunter, L. Alessio (eds.): *Occupational Health Guidelines for Chemical Risks*, CEC Publ. Eur 8513, Luxembourg 1983, pp. 128-129.

## 27 Molybdenum

ROGER F. SEBENIK (§§ 27.1, 27.4.1-27.4.4); ALFRED RICHARD BURKIN (§§ 27.2-27.3, 27.8); ROBERT R. DORFLER, JOHN M. LAFERTY (RETIRED) (§§ 27.4.1-27.4.4); GERHARD LEICHTFRIED (§§ 27.4.5-27.4.8, 27.5); PHILIP C. H. MITCHELL (§ 27.6); MARK S. VUKASOVICH (RETIRED) (§ 27.7 EXCEPT §§ 27.7.4.1-27.7.4.2); GERHARD ADRIAN (RETIRED); KARL BRANDT (§ 27.7.4.1); GÜNTER ETZRODT (§ 27.7.4.2); DOUGLAS A. CHURCH (§ 27.9); GARY G. VAN RIPER (§ 27.10); JAMES C. GILLILAND (RETIRED) (§§ 27.10-27.11); STANLEY A. THIELKE (§ 27.11)

27.1 History	1361	27.6.3 Halides	1381
27.2 Properties	1362	27.6.4 Molybdates, Isopolymolybdates, and Heteropolymolybdates	1382
27.3 Occurrence	1363	27.6.5 Other Compounds	1383
27.3.1 Minerals	1363	27.7 Uses of Molybdenum Compounds	1384
27.3.2 Deposits	1363	27.7.1 Lubrication	1386
27.4 Production	1365	27.7.2 Corrosion Inhibition	1387
27.4.1 Concentration	1365	27.7.3 Flame Retardancy and Smoke Suppression	1388
27.4.2 Processing of Concentrate	1367	27.7.4 Pigments	1388
27.4.3 Recovery from Spent Petroleum Catalysts	1369	27.7.4.1 Molybdate Red and Molybdate Orange	1389
27.4.4 Recovery during Production of Tungsten Ores	1371	27.7.4.2 Molybdate Pigments	1390
27.4.5 Production of Molybdenum Metal Powder	1371	27.7.5 Agriculture	1391
27.4.6 Production of Compact Molybdenum Metal	1372	27.8 Analysis	1391
27.4.7 Processing of Molybdenum	1373	27.9 Economic Aspects	1393
27.4.8 Alloys	1374	27.10 Environmental Aspects	1394
27.5 Uses	1375	27.11 Toxicology and Occupational Health	1396
27.6 Compounds	1376	27.12 References	1399
27.6.1 Oxides	1378		
27.6.2 Chalcogenides	1379		

### 27.1 History [1-4]

Molybdenum commonly occurs in nature as the mineral molybdenite,  $\text{MoS}_2$ , and is found as veins in quartz rock. It was discovered by SCHEELE in 1778, but for the next hundred years, molybdenite was merely a laboratory curiosity. The first major use came during World War I when additions of molybdenum produced steels with excellent toughness and strength at high temperatures for use as tank armor and in aircraft engines.

The main source of molybdenite throughout the 19th century was the Knaben mine in Norway in which the molybdenite was concentrated by hand. The World War I demand for molybdenum, however, spurred development of the Climax Mine (Colorado), which

was put on stream in 1918 by the Climax Molybdenum Company. By that time the froth flotation process had replaced hand sorting for concentrating ores.

Although the Climax Mine was closed after the war because of the suddenly decreased demand, it was reopened in 1924 as new peacetime uses of molybdenum, largely in the automotive industry, were developed. Demand for molybdenum steadily grew as new chemical and metallurgical applications continued to be developed, largely stimulated by the research efforts of the Climax Molybdenum Company.

In 1933 a process for the selective flotation of molybdenite from copper porphyry ores was developed by the Anaconda Company at its Cananea subsidiary in Mexico. The Ken-

necott Copper Company soon followed at its Utah mines. The technology was later extended to Chile at Kennecott's El Teniente Mine and Anaconda's Chuquicamata mine. Thus began the age of molybdenum production as a by-product of copper.

During World War II, the United States supplied about 90% of the world molybdenum demand, most coming from Climax with the balance from Kennecott's Utah mines and Molycorp's Questa mine. The largest of the other Western-world producing countries were Chile, Mexico, and Norway.

Climax Molybdenum Company continued to be the largest Western-World producer into the 1980s, doubling its capacity when it opened the massive Henderson mine (near Empire, Colorado) in 1976. Production from Mexico and Norway remained small, but less expensive by-product molybdenum production from Chile and the United States continued to grow, and the Endako and other mines in Canada began molybdenum production. In 1977, total world production exceeded 200 × 10<sup>6</sup> pounds (ca. 90 000 t) for the first time.

During the late 1970s the high price of molybdenum stimulated the opening of several new primary mines and the expansion of many by-product molybdenum facilities. When the price declined in the early 1980s, by-product molybdenum became the dominant economic force in the marketplace. Climax Molybdenum Company closed the underground mine at Climax, but was still a major producer with the Henderson mine and the open pit at Climax Cyprus Minerals, with four operating mines, became a major producer. Other important Western-world producers at the end of the 1980s were Codelco's Chuquicamata mine in Chile, Placer's Endako mine in Canada, the La Caridad mine in Mexico, and the Cuajone and Toquepala mines in Peru. Annual world production and consumption averaged (180–200) × 10<sup>6</sup> pounds (80 000–90 000 t) of molybdenum during the late 1980s.

## 27.2 Properties

**Physical Properties.** Molybdenum, electronic configuration [Kr] 4d<sup>5</sup> 5s<sup>1</sup>, is the second member of group 6 of the periodic table. As a transition element it may have a valency of 2, 3, 4, 5, or 6: In the massive state molybdenum is a lustrous silver-white solid with typically metallic properties. When produced as a powder it is dull grey. It has a body-centred cubic lattice with  $a_0 = 0.31472$  nm. The physical properties of molybdenum depend to a large degree on the method used to produce it and on its subsequent treatment. For example, its relative density calculated from  $a_0$  is 10.22 whereas an earlier measurement gave 9.01 and later work showed that the lower value increases with the amount of mechanical working to which the metal is subjected. The accepted values of the main physical properties of the metal are given below. A more extensive compilation is available giving, in particular, data of importance to metallurgists [5].

<i>mp</i>	2617 °C
<i>bp</i> (101.3 kPa)	4612 °C
Latent heat of fusion at <i>mp</i>	35.6 kJ/mol
Mean specific heat (0–100 °C)	251 Jkg <sup>-1</sup> K <sup>-1</sup>
Density (20 °C)	10.22 g/cm <sup>3</sup>
Thermal conductivity (0–100 °C)	137 Wm <sup>-1</sup> K <sup>-1</sup>
Electrical resistivity (20 °C)	5.7 μΩ·cm
Temperature coefficient (0–100 °C)	4.35 × 10 <sup>-3</sup> K <sup>-1</sup>
Elastic constants of polycrystalline metal (20 °C)	
Young's modulus	324.8 GPa
Rigidity modulus	125.6 GPa
Bulk modulus	261.2 GPa
Poisson's ratio	0.293
Linear coefficient of thermal expansion (0–100 °C)	5.1 × 10 <sup>-6</sup> K <sup>-1</sup>
Standard electrode potential $E_{\text{Mo}^{3+}, \text{Mo}}^0$	-0.200 V

**Chemical Properties.** Molybdenum retains its luster almost indefinitely in air, particularly when it has been drawn to fine wire. It can be passivated by oxidation, especially by electrolytic oxidation, becoming chemically unreactive. On prolonged heating in air below 600 °C, the metal becomes covered with its trioxide; at 600 °C the oxide sublimates and rapid oxidation occurs. Molybdenum burns in oxygen at 500–600 °C. It is slowly oxidized by steam, is attacked by fluorine when cold and by chlorine and bromine when hot. Dilute

acids and concentrated hydrochloric acid have very little effect on the metal. Moderately concentrated nitric acid dissolves it but concentrated nitric acid soon passivates the surface and reaction ceases. Molybdenum is dissolved by a mixture of concentrated nitric and concentrated hydrofluoric acids. It is practically unaffected by alkaline solutions and very nearly so by fused alkali-metal hydroxides. However fused oxidizing salts such as sodium peroxide, sodium or potassium nitrate or perchlorate dissolve the metal rapidly. It reacts on heating with carbon, boron, nitrogen, and silicon and forms many alloys. It is used in a variety of catalysts, especially combined with cobalt in the desulfurization of petroleum. Molybdenum is a biologically active metal which is involved in the functioning of enzymes causing reduction of nitrogen to ammonia, and of nitrates.

## 27.3 Occurrence

### 27.3.1 Minerals

Molybdenum occurs in the earth's crust in an abundance of about 10<sup>-4</sup>%, mainly as molybdenite, MoS<sub>2</sub>. Small quantities are also associated with other metals having similar chemical properties. Thus wulfenite (PbMoO<sub>4</sub>) is found in oxidized parts of sulfidic lead deposits in many regions of the world; powellite [Ca(Mo,W)O<sub>4</sub>] is a calcium molybdate usually formed from the modification of molybdenite in deposits containing tungsten as scheelite (CaWO<sub>4</sub>) and tungsten substitutes for molybdenum up to about 10%. Ferrimolybdate (Fe<sub>2</sub>Mo<sub>3</sub>O<sub>12</sub>·8H<sub>2</sub>O) is the product of oxidation of molybdenite in the presence of iron(III) compounds. Molybdenite is the primary source of molybdenum. Should demand for molybdenum rise so that additional sources become necessary, wulfenite, powellite, and ferrimolybdate may become commercially significant. Other molybdenum minerals include achrematite, belonesite, chilagite, eosite, ilsemanite, jordisite, koechlin-

ite, lindgrenite, and paterite. These are of no commercial importance however.

### 27.3.2 Deposits

There are five genetic types of molybdenum deposits:

- Porphyry deposits in which metallic sulfides are disseminated throughout large volumes of altered and fractured rock
- Contact-metamorphic zones and bodies in which silicated limestone is adjacent to intrusive granites
- Quartz veins
- Pegmatites
- Deposits bedded in sedimentary rocks.

The first three types are of hydrothermal origin and provide almost all of the molybdenum ore currently mined. The last two are of no economic importance at present. Average molybdenite concentrations in primary porphyry deposits range from 0.05 to 0.25%; in secondary copper molybdenum porphyry deposits molybdenite concentrations are much lower (0.01–0.05%) so that the mineral can only be recovered as a by-product.

In hydrothermal deposits, the cracks and interstices of the intrusive rock forming the matrix were originally penetrated by aqueous metal-containing solutions. Such solutions are often formed close to magma and so are at a high temperature and pressure and contain sulfide species. As the solution cools, minerals are deposited within the intrusive matrix and also commonly in the surrounding country rock. Thus the famous deposit at Climax, Colorado (USA) was formed by an intrusion of a quartz-monzonite magma into a granitic country rock. The hydrothermal solution deposited quartz and molybdenite in even the smallest fractures so that the host rock appears to consist of angular fragments separated by narrow bands of the minerals. In many porphyry deposits small amounts of molybdenite are disseminated with copper sulfide minerals throughout large volumes of granitic rock. The chief mineral values are chalcopyrite (CuFeS<sub>2</sub>) and chalcocite (Cu<sub>2</sub>S), associated



with pyrite (FeS<sub>2</sub>), and small amounts of other sulfides, including molybdenite. Where secondary enrichment of the copper ore has occurred, chalcocite has replaced pyrite and chalcopyrite. In limestone silicate sedimentary rocks containing intrusions of granitic rocks, small amounts of molybdenite are occasionally widely distributed along the interfaces between the rocks and are often associated with scheelite (CaWO<sub>4</sub>), bismuthinite (Bi<sub>2</sub>S<sub>3</sub>), or copper sulfides. These deposits may contain up to 0.6% molybdenite.

Pegmatites are the result of igneous activity and subsequent solidification of the magma. The slow cooling of the mass results in the formation of coarse crystals, almost exclusively of quartz and feldspar. Molybdenite occurs in small amounts as an accessory mineral, usually as large crystals; pegmatites are not an important source of molybdenum. Nevertheless, a pegmatite deposit containing molybdenite together with bismuth was mined until recently at Val d'Or and Preissac (Québec, Canada). Sedimentary rocks in which molybdenum minerals may occur include coals, shales, phosphorites, and sandstones. They are not used as sources of molybdenum and the technology to recover it from them has not been developed.

Molybdenum is obtained commercially almost exclusively from molybdenite, which is either mined and concentrated as the primary product of the mine or open pit, or recovered as a concentrate during the processing of ore from a copper mine. In the latter case the molybdenite can be either a by- or a coproduct, depending on its economic importance to the output of the mine. Molybdenum is also recovered from solutions obtained by leaching scheelite ores in the production of tungsten. Molybdenum supply in the Western world can be broken down into four production segments [6]:

- Primary mine production (ca. 40%)
- By- or coproduction output from copper and scheelite mines (ca. 55%)
- Imports from China (3%)

- Molybdenum recovered from the processing of spent petroleum catalyst (2%).

Reserves of molybdenite in the market economy countries have been estimated by evaluating identified ore bodies [7], i.e., those which have been explored as well as those which have been exploited. The results indicate the following amounts of recoverable molybdenum (10<sup>3</sup> t): United States, 4100; Chile, 1770; Canada, 928; Mexico, 306; Peru, 288; other countries, 356. Ore bodies producing primarily molybdenum contain 55% of the reserves identified; only 29% of these ore bodies were being exploited at the time of the survey (January 1985). Properties producing molybdenum as a by-product contained the remaining 45% of reserves and 67% of them were producing molybdenite. The total recoverable molybdenum from primary and by-product reserves has been estimated as follows (10<sup>3</sup> t molybdenum in concentrate) [8]:

Primary producing properties	1265
Primary nonproducing properties	3036
By-product producing properties	2316
By-product nonproducing properties	1142

Molybdenum occurs widely in all continents but usually in small quantities. The large-scale mining, milling, and processing facilities now required for economic production of molybdenum compounds are only justified where large reserves of ore exist. Where these are exploited they are the primary molybdenum producing mines. In Canada, Endako (Placer Dome) is the only primary molybdenum mine and is in British Columbia. The Cumobabi mine (Empresso Frisco SA de CV) is in Mexico; the Jinduicheng mine is the largest molybdenum producer in China and all of the others, except perhaps for some in the former Soviet Union, are in the United States. In Alaska, Quartz Hill is under long-term development. The famous, very large Climax and Henderson mines (both Amax) are in Colorado; Thompson Creek (Cyprus Minerals) is in Idaho; Tonopah (Cyprus Minerals) is in Nevada; and Questa (Molycorp) is in New Mexico. A detailed list of major molybdenum-producing companies is given in [8].

Molybdenum is extracted as a by-product or coproduct of copper production in Canada, Chile, Iran, Mexico, Papua New Guinea, Peru, Philippines and, in the United States (Arizona, Nevada, New Mexico, and Utah). It is extracted from the scheelite mine at Sang-dong, Gangwondo, Korea (Korea Tungsten Mining) as a by-product of tungsten recovery.

## 27.4 Production

### 27.4.1 Concentration [9]

Molybdenum ore is mined by underground and open-pit methods. A typical primary molybdenum ore body contains 0.05–0.25% Mo, and secondary ore bodies (copper porphyry ores) average 0.3–1.6% Cu and 0.01–0.05% Mo. Flotation remains the preferred and almost exclusive method of upgrading the molybdenite mineral to an industrial-grade molybdenite concentrate containing 90–95% MoS<sub>2</sub>, the balance being gangue.

The flotation process [10, 11] starts by pulverizing the ore to liberate the molybdenite (either alone or in association with copper sulfide minerals) from the host rock (mainly quartz monzonite), and then agitating the pulverized ore with water, a collector oil, and other special chemicals to cause preferential wetting of the host rock particles. The unwetted copper and molybdenum mineral particles are carried to the surface by air bubbles as the wetted host rock particles settle or remain suspended. A frothing agent is used to stabilize the bubbles, which contain the sulfide minerals, for easy skimming from the surface.

Molybdenite flotation is so spontaneous that it is termed a natural floater. Other minerals, such as clay and covellite (CuS), that are commonly associated with molybdenite-containing ores are, however, also natural floaters. For this reason the flotation process for molybdenum production from primary ore bodies differs from that of secondary ore bodies. Factors such as the grinding method, particle size, alkalinity, slurry density, and reagent usage dictate the recoveries and process economics.

**Recovery from Primary Ore Bodies.** Figure 27.1 illustrates a basic recovery flowsheet from a primary molybdenum ore body. Although the methods of comminution vary, the objectives are to break down the ore to liberate the molybdenite. For example, Climax uses primary, secondary, and tertiary crushing with screening and rougher ball mills in closed circuit with spiral and hydrocyclone classification to produce a flotation feed [12]. Henderson [13] and Thompson Creek [14] use primary crushing and semi-autogenous grinding in closed circuit with hydrocyclone classification.

An initial primary grind [ca. 48%–200 mesh (74 μm)] is usually acceptable to produce a 2.5–5.0% Mo concentrate in the first “rougher” flotation stage. This concentrate is then upgraded by further grinding and “cleaner” floating. This concept of upgrading progressively smaller volumes of concentrate has proved to be the most cost effective means of handling large tonnages of low-grade molybdenum ores.

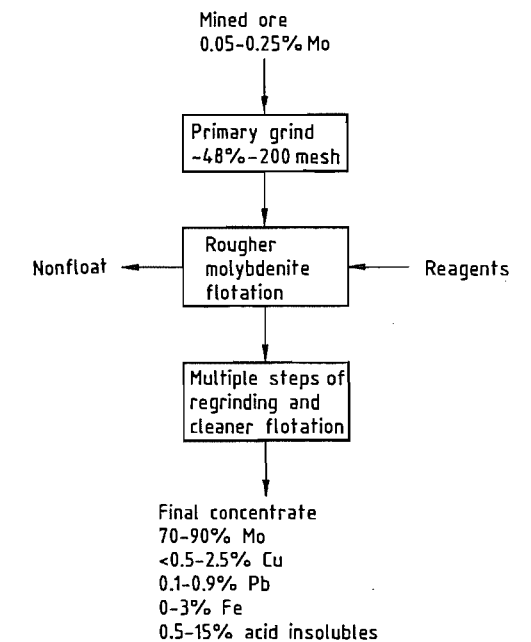

Figure 27.1: Primary molybdenite recovery process [9].

Sufficient regrind and cleaner steps follow to obtain the degree of liberation required for a final concentrate grade. For example, six cleaner flotation steps are used at Thompson Creek [14], five at Climax [12], and four at Henderson [13]. The nonfloat from the last stage of cleaner flotation is circulated counter-currently through the previous cleaner stages. Overall recovery is generally about 85%.

At each flotation step molybdenite particles are floated and collected, and contaminants are depressed and rejected by adding reagents. Different reagent programs are used depending on the properties of the mined ore [15]. Simple hydrocarbon collectors can be used such as kerosene, stove oil, or light oil. Pine oils and Syntex VB (sulfated monoglyceride of coconut oil), which also have emulsifying and collecting properties, are used as frothers; lime or soda ash is used to control alkalinity, usually at pH 8.5. Contaminants are rejected by controlling the pH at an optimum level and by adding depressing reagents such as Noke's reagent (a product formed by reaction between stoichiometric quantities of sodium hydroxide and phosphorus pentasulfide) and sodium cyanide. Sodium silicate is used to disperse slimes.

**Recovery from Secondary Ores.** The generally accepted practice for secondary molybdenum recovery (Figure 27.2) is to float a copper-molybdenum sulfide concentrate and then extract the molybdenum from the combined concentrate by methods governed by the type of copper mineralization present.

In practice, fine grinding [50–70%–200 mesh (74  $\mu\text{m}$ )] is usually performed to maximize copper recovery [16]. Then bulk flotation of the molybdenum-copper sulfide concentrate generally employs strong alkyl xanthates (e.g., potassium amyl xanthate or sodium isopropyl xanthate) and nonselective frothers (e.g., methylisobutylcarbinol) to float as much of the total copper-molybdenum product as possible.

The bulk copper-molybdenum flotation stream is thickened by settling the solids and decanting the clear process water to obtain a

copper-molybdenum slurry with a higher solids content. The slurry is conditioned by adding reagents during the thickening step as a method of premixing the reagents that will be used in the rougher flotation step.

On a worldwide basis, molybdenum losses in the copper molybdenum bulk flotation process amount to about 48% of the total molybdenum feed, but this level is gradually being reduced. Most of the molybdenum losses are incurred because the circuits are designed and operated for optimum copper recovery.

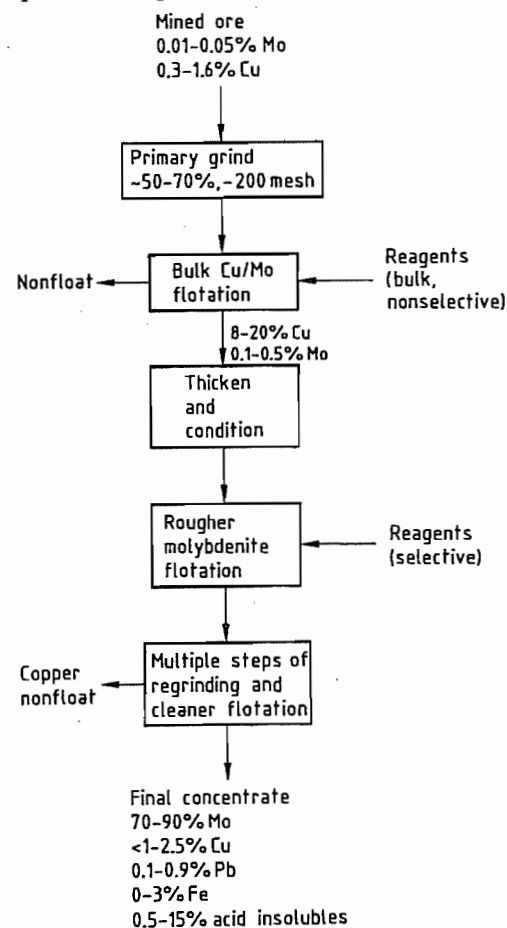

Figure 27.2: By-product copper-molybdenite recovery process [9].

Selective collectors [17] are then used for separating molybdenum from the bulk copper molybdenum concentrate beginning in the

rougher flotation stages. For example, chalcocite ( $\text{CuFeS}_2$ ), the most common type of copper mineralization, is particularly amenable to sodium hydrosulfide treatment. It is depressed with a 40% solution of sodium sulfide or hydrosulfide. The hydrosulfide ion in the solution preferentially desorbs the bulk collector from the copper sulfide mineral, leaving it in the water-wetting nonfloating condition.

Hypochlorides, peroxides, permanganates, and dichromates can also oxidize the adsorbed collectors giving an initial depressing effect to copper sulfides; cyanides will further depress copper to yield a high-grade molybdenite concentrate. When using these oxidants and depressants, chalcocite ( $\text{Cu}_2\text{S}$ ) ores require more circuit design, i.e., additional flotation stages and more reagent addition points.

Covellite ( $\text{CuS}$ ) ores float naturally and have been removed from flotation (depressed) with lignin sulfonate but now the simpler process of adding excess collector is used. Clays have been depressed with aluminum sulfate. Noke's reagent is a strong but short-lived depressant of copper sulfides. Lime is used for pH control at 9.5–11.5 to diminish pyrite flotation.

Sufficient grind and cleaner steps follow to obtain the desired degree of separation of the copper ore and molybdenite. Common reagents used for cleaner flotation are diesel oil and other light hydrocarbons. The nonfloat copper ore is filtered and dried before being converted to copper metal by smelting. The floated  $\text{MoS}_2$  is filtered to remove bulk water. The wet, oily  $\text{MoS}_2$  is not treated any further before roasting to  $\text{MoO}_3$ .

A careful balance of all reagent combinations must be determined in actual plant practice. The scarcity of collector oils has initiated intensive studies of collector substitutes, and environmental considerations are causing concentrators to move away from cyanides, arsenates, chromates, and other hazardous reagents.

## 27.4.2 Processing of Concentrate

**Direct Use.** Some commercial-grade molybdenite concentrate is subjected to additional

grinding and flotation to produce lubricant-grade molybdenum disulfide (99%  $\text{MoS}_2$ ). Residual flotation oils and water are then volatilized by passing the upgraded concentrate through an inert-gas-swept kiln. This high-purity product is added to grease and oils as a solid lubricant.

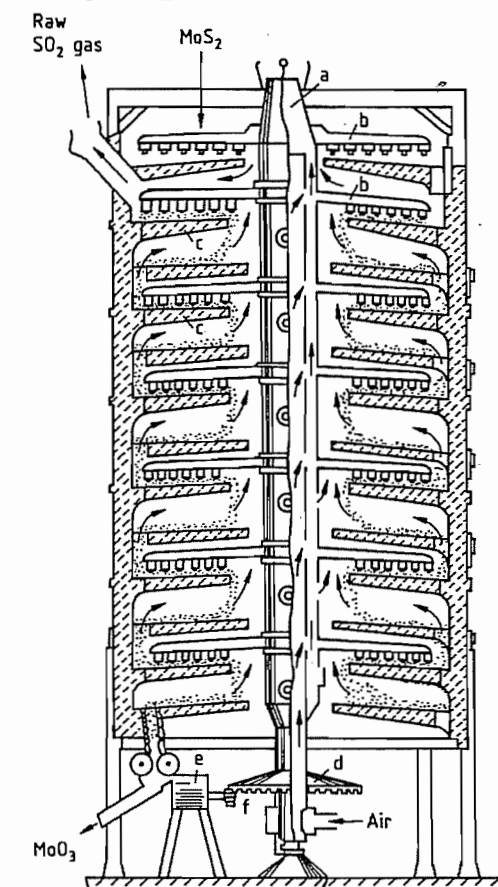

Figure 27.3: Multiple-hearth roasting furnace of the Nichols-Herreshoff type [20]: a) Rotating hollow shaft for passage of air to hearth; b) Rabble arms connected to shaft; c) Multilevel hearths; d) Beveled gear; e) Motor; f) Drive gear.

**Production of Molybdenum Trioxide.** The principal commercial molybdenum product is *technical-grade molybdenum trioxide* ( $\text{MoO}_3$ ). In addition to being the major compound for adding molybdenum to steel, it is also the starting compound for all other molybdenum products including ammonium di-

molybdate, pure molybdenum trioxide, sodium molybdate, molybdenum metal, and ferromolybdenum.

Molybdenite is converted to technical-grade  $\text{MoO}_3$  by roasting it in air in a multiple-hearth furnace of the Nichols–Herreshoff or Lurgi design [16, 17], (Figure 27.3). The roasted  $\text{MoO}_3$  product typically contains < 0.1% sulfur. The multiple-hearth furnace is used because the hearths can be segmented to accomplish specific and different conversion operations within a single unit. Figure 27.4 shows the hearth-by-hearth composition of the molybdenum during roasting [18].

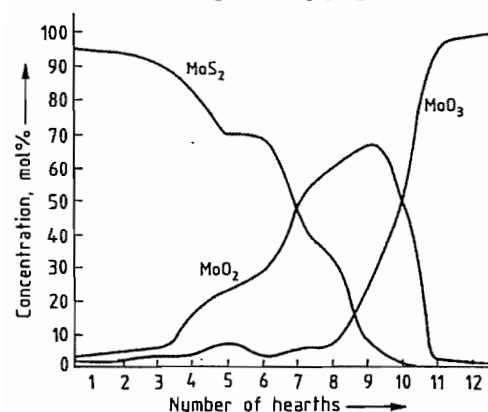
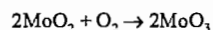
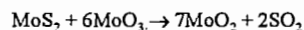
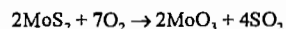

Figure 27.4: Composition of molybdenum sulfide and oxide in multiple-hearth roasting [18].

The upper hearths of the furnace are mainly used to burn off flotation oils and evaporate water. This part of the process is usually augmented by burning fossil fuels to ensure consistent temperature control and uniform roasting throughout the remainder of the unit. Upper hearth temperatures range between 600 and 700 °C.

The bulk of the sulfur is removed by oxidation in the intermediate hearths:



Since the sulfur oxidation reactions are highly exothermic, additional heating is not needed in this section. The hearth temperatures are controlled between 600 and 650 °C by the ad-

dition of excess air and/or with water spray cooling.

As sulfur burning nears completion, the composition of the roaster hearth is mostly  $\text{MoO}_2$  with < 20%  $\text{MoO}_3$  and  $\text{MoS}_2$ . The reaction of  $\text{MoO}_3$  with  $\text{MoS}_2$  to form  $\text{MoO}_2$  is driven by the strong oxidizing power of  $\text{MoO}_3$ , so that the production of  $\text{MoO}_3$  is limited until most of the  $\text{MoS}_2$  is gone.

Once the availability of  $\text{MoS}_2$  is less than the availability of  $\text{MoO}_3$ ,  $\text{MoO}_2$  is rapidly converted to  $\text{MoO}_3$ . Although this reaction is exothermic, it is not sufficient to maintain the temperatures above 525 °C which are required to complete sulfur removal and conversion to  $\text{MoO}_3$ . Hence supplementary heating is required in these lower hearths. The oxide product is discharged from the roaster, cooled, and milled to form technical-grade  $\text{MoO}_3$ . Technical-grade  $\text{MoO}_3$  typically contains 85–90%  $\text{MoO}_3$ , the balance being silica with some  $\text{Fe}_2\text{O}_3$  and  $\text{Al}_2\text{O}_3$ .

Sulfur dioxide and sulfur trioxide leave the roaster in the flue-gas stream. This gas stream is handled by methods which comply with emission regulations. The most common are contacting the off-gas with lime to produce disposable  $\text{CaSO}_4 \cdot 2\text{H}_2\text{O}$  and the production of sulfuric acid. Sulfuric acid is produced by catalytically oxidizing the sulfur dioxide to sulfur trioxide which is absorbed by a  $\text{H}_2\text{SO}_4$  solution.

In addition to sulfur removal, certain metal contaminants tend to vaporize during the roasting process. Any rhenium oxide,  $\text{Re}_2\text{O}_7$ , in the concentrate can be scrubbed from the off-gas stream and recovered by solvent extraction or ion-exchange processes. Selenium oxide,  $\text{SeO}_2$ , is also preferentially vaporized and can be collected to avoid creating an environmental hazard.

In many cases chemical leaching of the concentrate is required prior to roasting to preferentially remove nonferrous impurities detrimental to steel production. Three leaching processes are practiced:

- Sodium cyanide leachate is used for copper and gold removal

- Iron(III) chloride for copper, lead, and calcium removal
- Hydrochloric acid for lead and bismuth removal.

Pure molybdenum trioxide can be produced from technical-grade  $\text{MoO}_3$  via calcination of ammonium dimolybdate (ADM) or by sublimation.

Ammonium dimolybdate is obtained by first leaching the technical-grade oxide with water at ca. 75 °C to remove soluble alkali impurities, primarily potassium [20, 21]. The oxide is then filtered and dissolved in a 10–20% ammonium hydroxide solution at 40–80 °C to form ammonium molybdate:

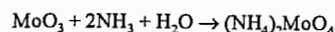

The ammonium molybdate solution is separated from the insoluble gangue minerals (primarily silica and some iron) by filtration and then further purified by precipitation of the heavy metals (e.g., copper) with sulfide. The filtered solution is then fed to an evaporative crystallizer operating at atmospheric pressure to produce ADM crystals:

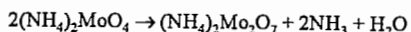

Varying degrees of rejection for sodium, calcium, magnesium, and aluminum occur during crystallization and these impurities build up in the mother liquor. They are eliminated by periodic purging of the crystallizer. The ADM crystals are recovered by centrifugation and then dried. Calcining the ammonium dimolybdate in an indirectly fired rotary kiln at temperatures in excess of 420 °C produces pure  $\text{MoO}_3$ .

Pure  $\text{MoO}_3$  is also produced by sublimation of technical-grade  $\text{MoO}_3$  [22]. The oxide is heated to 1100–1200 °C as a thin layer on a doughnut-shaped furnace hearth that rotates under electrical resistance heating elements. Air is drawn over the heated surface and sweeps away the vaporized  $\text{MoO}_3$ , leaving the nonvolatile gangue and other metallic impurity elements behind. The charge on the hearth makes one pass under the heating elements. The residue, still rich in molybdenum, is discharged for use as a steel additive. The subli-

mation yield is about 60–70%. The sublimed vapor is then cooled, condensed, and collected in baghouses prior to densifying, screening, and packaging.

The molybdenum oxides produced by the ADM and sublimation processes are both of high purity (99.9%  $\text{MoO}_3$ ). Compared to calcined ADM, sublimed pure oxide has a significantly lower alkali content, but higher silica, iron, lead, and tin levels. Sublimed pure oxide also tends to be finer in size and acicular (needle-like) in shape.

Sodium molybdate (and other similar molybdates) may also be produced from technical-grade  $\text{MoO}_3$  [23], although pure  $\text{MoO}_3$  is a common, but more expensive, starting material. Technical-grade  $\text{MoO}_3$  is leached as in the ADM process and then dissolved in sodium hydroxide at 50–70 °C to produce an almost saturated solution of sodium molybdate. A minimum excess of caustic (NaOH) is maintained to inhibit silica dissolution; a small quantity of sulfide ion is added to precipitate heavy metals. If pure oxide is used, the initial leaching step is eliminated.

After filtration, the solution is fed to an evaporative crystallizer to produce sodium molybdate dihydrate ( $\text{Na}_2\text{MoO}_4 \cdot 2\text{H}_2\text{O}$ ). If crystallization is performed below 10 °C, the decahydrate is formed ( $\text{Na}_2\text{MoO}_4 \cdot 10\text{H}_2\text{O}$ ). The crystals are recovered by centrifugation and dried at 70 °C. Anhydrous sodium molybdate ( $\text{Na}_2\text{MoO}_4$ ) is produced by drying at > 100 °C.

### 27.4.3 Recovery from Spent Petroleum Catalysts

Molybdenum-containing catalysts are widely used in the petroleum refining industry for mild hydrogenation and removal of heteroatoms such as sulfur (hydrodesulfurization), nitrogen, and oxygen, as well as metals like nickel and vanadium. A typical catalyst uses molybdenum in combination with cobalt or nickel on a porous alumina ( $\text{Al}_2\text{O}_3$ ) support. The composition range of such a catalyst when spent is 2–10% Mo, 0–12% V, 0.5–4%

Co, 0.5–10% Ni, 10% S, 10% C, with the balance being  $Al_2O_3$ .

Numerous approaches have been explored to recover the metal values from spent catalysts. The fundamental strategy involves:

- Initial heat treatment in air to remove the residual sulfur, carbon, and hydrocarbons, and to oxidize the metals to soluble molybdate and vanadate.
- A leaching step resulting in preferential solubilization of molybdate and vanadate, leaving the Ni–Co–alumina as a solid.
- Separation of the Mo and V.
- Treatment of the Ni–Co–alumina residue to recover Ni and Co.

#### Production of Molybdate and Vanadate.

One basic process is to roast the ground (100 mesh,  $< 149 \mu m$ ), spent catalyst in air at 600 °C and then mix the roasted material thoroughly with soda ash ( $Na_2CO_3$ ) [24]. The  $Na_2CO_3$ –spent catalyst mix is roasted again in air at 600–800 °C to convert the molybdenum and vanadium oxides to soluble sodium molybdate and sodium vanadate, respectively:

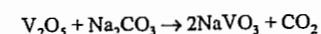
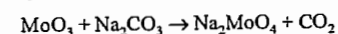

The roasted mix is leached with water at up to 100 °C to dissolve the soluble molybdenum and vanadium compounds. The molybdenum- and vanadium-containing solution is recovered by filtration for subsequent separation; the insoluble Ni–Co–alumina filter cake is treated separately to recover the respective metal values. A similar process uses sodium chloride instead of soda ash and results in the same sodium molybdate–sodium vanadate solution [25].

An alternative process uses wet-air oxidation to combine the first two oxidation steps [26]. The as-received and ground (100 mesh,  $< 149 \mu m$ ) spent catalyst is slurried with water and soda ash at temperatures up to 300 °C and air pressures up to ca. 17 MPa (2500 psi). The molybdenum and vanadium sulfides are directly converted to soluble sodium molybdate and vanadate, respectively:

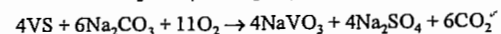
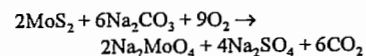

In addition all the carbon and hydrocarbons are oxidized (burned off). The nickel and cobalt sulfides are also oxidized and the sulfur is converted to sodium sulfate. The Ni–Co–alumina remains insoluble as in the previous processes.

#### Recovery of Molybdenum and Vanadium.

A number of technologies are available for recovering the metal values from the molybdenum- and vanadium-containing solution [26]. For example, addition of ammonium chloride or ammonium sulfate precipitates the vanadium as ammonium vanadate,  $NH_4VO_3$ , which is removed by filtration [24]. The molybdenum can then be precipitated as calcium molybdate by adding lime.

In another method, treating the solution with hydrogen sulfide under very acidic conditions (1–2 mol/L  $H_2SO_4$ ) preferentially precipitates molybdenum trisulfide. The vanadium remaining in solution can be precipitated as the hydrated oxide,  $V(OH)_4 \cdot 1.5H_2O$ , by neutralization of the solution with sodium hydroxide, or as red cake ( $Na_2H_2V_6O_{17}$ ) by first oxidizing the vanadium in solution with  $NaClO_3$  and adjusting the pH to about 6 with NaOH or  $Na_2CO_3$ . In a final solvent extraction method the vanadium is preferentially extracted from the solution with a quaternary ammonium compound such as Aliquat 336 (tricapryl monomethyl ammonium chloride). The molybdenum can then be extracted with a secondary amine such as Adogen 283, a ditridecylamine.

**Recovery of Nickel and Cobalt.** A number of technologies are also available to recover the nickel and cobalt from the alumina. They can be leached from the alumina with 5% HCl or  $H_2SO_4$  solution at 75 °C [27]. They can also be recovered by caustic digestion of a slurry of the Ni–Co–alumina residue in a 25% caustic (NaOH) solution at 250 °C for 2 h [26]. The dissolved nickel and cobalt are recovered and separated by other methods standard in the nickel industry.

### 27.4.4 Recovery during Production of Tungsten Ores

The occurrence of tungsten ores, such as scheelite ( $CaWO_4$ ), is commonly associated with trace amounts of powellite ( $CaMoO_4$ ). Most of the powellite stays with the scheelite during its processing to a sodium tungstate solution by soda ash digestion in an autoclave. The powellite forms sodium molybdate and is solubilized. This is not a significant source of molybdenum and the recovered molybdenum is usually discarded because it is contaminated with tungsten. However the molybdate is routinely removed from the tungstate solution to purify the tungsten.

The most common method of removing molybdenum from a sodium tungstate solution is to treat the solution with sodium sulfhydrylate,  $NaSH \cdot 2H_2O$  [28]. This compound reacts with the sodium molybdate and some of the sodium tungstate to precipitate the trisulfides,  $MoS_3$  and  $WS_3$ , respectively. The precipitate generally contains two to three parts of molybdenum to one part of tungsten; it can be calcined to give the relevant oxides and then leached with strong hydrochloric acid to dissolve the molybdenum, leaving the tungsten.

### 27.4.5 Production of Molybdenum Metal Powder

Molybdenum metal powder is produced industrially [30] by reducing high-purity molybdenum compounds with hydrogen. The following compounds are used:

- Molybdenum trioxide,  $MoO_3$  (grey-green powder).
- Ammonium hexamolybdate,  $(NH_4)_2Mo_6O_{19}$  (yellow powder).
- Ammonium dimolybdate,  $(NH_4)_2Mo_2O_7$  (white powder).

To allow further processing by powder metallurgy, reduction conditions should result in a powder that can be pressed and sintered. Reduction is usually performed in two stages:

- Reduction to  $MoO_2$  (molybdenum red).
- Reduction of  $MoO_2$  to molybdenum metal powder.

This gives satisfactory yields of a completely reduced powder with the desired particle size distribution and a sufficiently high specific surface area in a reasonable length of time. Since reduction to  $MoO_2$  is exothermic, this step is performed at 600 °C to prevent caking due to the melting of  $MoO_3$  ( $mp$  800 °C). The  $MoO_2$  is reduced to molybdenum powder at ca. 1050 °C. The powder has a particle size of 2–10  $\mu m$ , a specific surface area of 0.1–1  $m^2/g$ , and an oxygen content of 100–500 mg/kg (partly adsorbed and partly as oxide).

Reduction is usually performed in an electrically heated continuous furnace (e.g., a pusher furnace, a walking beam furnace, or a rotary kiln) with a counterflowing stream of hydrogen. Reduction in fluidized-bed reactors is also known. Introduction of impurities should be avoided at all stages. Molybdenum powder 5N5 with an impurity content of  $\leq 5$  mg/kg can be produced; this figure does not, however, take into consideration gases and refractory metals. Special purification procedures such as multiple recrystallization, ion exchange, solvent extraction and adsorption are used to remove undesirable impurities such as alkali metals, ferrous metals, and radioactive elements from molybdenum to be used in the semiconductor industry. Special mixer linings, furnace linings, and sintering boats prevent contamination with iron and ceramic particles.

Good flow properties and a constant apparent density are critical for satisfactory processing of molybdenum powder in automatic presses. Molybdenum powder is typically mixed with an organic binder, e.g., poly(vinyl alcohol), and a volatile agent, e.g., water. The slurry is sprayed into a heated free-fall chamber where spherical agglomerates are formed due to surface tension. Heating causes vaporization of the volatile agent, giving a hard, densely packed agglomerate (spray-drying process).

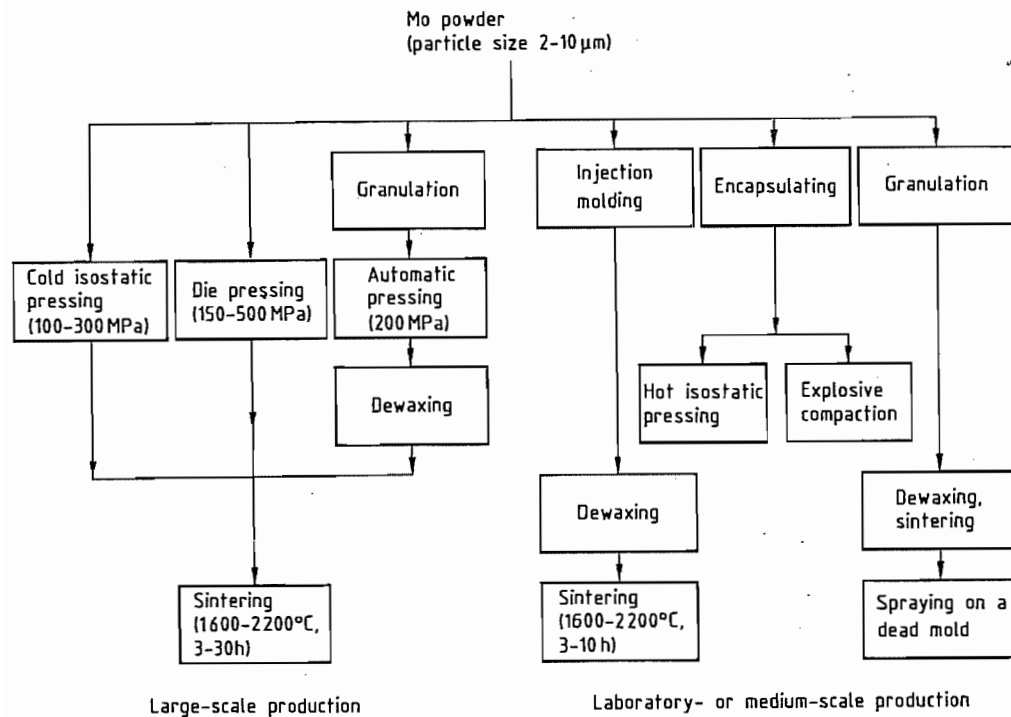

Figure 27.5: Production of molybdenum by powder metallurgy.

#### 27.4.6 Production of Compact Molybdenum Metal [30, 31]

More than 95% of the total world production of molybdenum and molybdenum alloys high in molybdenum is produced by powder metallurgy, the remainder is obtained by vacuum arc remelting and electron beam melting.

Molybdenum produced initially by melting has to be worked by extrusion due to its coarse-grained, columnar microstructure; metal produced by powder metallurgy can, however, be worked by almost all standard hot metalworking techniques.

**Production by Powder Metallurgy.** More than 99% of industrially produced molybdenum is prepared by the method shown on the left-hand side of Figure 27.5. In the case of large workpieces and round bars, the molybdenum powder is filled into rubber containers that are sealed and then compressed isostatically at 100–300 MPa. Due to frictional

losses, a somewhat higher pressure (150–500 MPa) is used with die presses.

Sintering with resistance heating according to the Coolidge method is still used but indirect heating with tungsten heating elements is now the most common method. This procedure has a lower specific energy consumption, produces a homogeneous structure, and can be used to sinter large and complex components. Large items weighing up to 5 t (such as are used in isothermal forging dies) can only be produced by this method.

Depending on furnace design and the molybdenum alloy, sintering is performed at 1600–2200 °C for 3–30 h in a hydrogen atmosphere. Minimum sinter densities of 90%, but preferably 95%, are required to avoid subsequent processing difficulties. Neck formation between the particles starts at ca. 1200 °C and shrinkage at ca. 1600 °C. Addition of small quantities of platinum, palladium, or nickel allows the sintering temperature to be reduced

to 1300–C. These dopants have a low solubility in molybdenum and accumulate at the grain boundaries where they accelerate diffusion but have an adverse effect on ductility.

**Production by Melting.** Vacuum arc furnaces are used for large-scale melting of molybdenum. Electron beam devices are, however, used for special applications, particularly for the production of sputtering targets. Presintered molybdenum rods are fed into the electric arc furnace as electrodes and melted. In electron beam devices, sintered or hot isostatically compressed molybdenum rods are used. The resulting molybdenum billets are extruded by the Séjournet process. In this process the heated billet is rolled over a bed of glass powder, which softens during contact, insulates the tooling from the hot billet, and lowers oxidation.

Recent efforts have been directed at producing a fine-grained as-cast structure by vacuum double-electrode remelting or cold hearth electron beam melting. This should give molten molybdenum which can be processed immediately without intermediate hot extrusion.

#### 27.4.7 Processing of Molybdenum

**Manufacture of Semifinished Products.** Molybdenum produced by powder metallurgy can be processed into semifinished articles by almost all classical forming techniques. High temperatures are, however, necessary and special equipment and tools are required. In molybdenum produced by melting the initial forming steps are important for obtaining a fine-grained structure.

The sintered starting material first has to be preheated to 1200–1400 °C to prevent any damage occurring during the first deformation steps. In this temperature range the tensile strengths of some molybdenum alloys correspond to those of hot-work tool steels at 700 °C. Preheating can be performed in electrical or gas-fired furnaces in a neutral or reducing atmosphere. Processing is carried out in air even though considerable oxidation occurs at this temperature. Embrittlement does

not occur because oxygen and nitrogen are almost completely insoluble in molybdenum.

As forming proceeds, ductility increases and the temperature can gradually be reduced to room temperature. After hot and cold working, the molybdenum is subjected to stress-relief annealing at ca. 800 °C.

Large items are produced by press forging. Round products (diameter 10 μm to ca. 200 mm) are manufactured by extruding (Séjournet method), forging, swagging, rolling, or drawing. Sheets are available in thicknesses of 10 μm to 50 mm.

**Manufacture of Finished Products.** Molybdenum can be worked by most of the customary techniques (e.g., deep drawing, flow turning). The working temperature should be higher than the ductile-to-brittle transition temperature but lower than the recrystallization temperature (1100 °C).

Molybdenum can readily be machined by chip removal and by electrical discharge. Tools used for milling, turning, and planing should comply with ISO hardmetal K specifications and have a highly positive cutting geometry. Since the cutting edges of the tools must be extremely sharp, coated indexable inserts are unsuitable. Commercially available emulsions or, in special cases, highly chlorinated hydrocarbons are used as coolants and lubricants.

When ceramic silicon carbide disks are used for grinding, low speeds must be used (< 33 m/s) to avoid buildup of heat. Molybdenum is machined by electrical discharge with zinc-coated brass wires and behaves similarly to hard metals. Graphite or tungsten copper electrodes are recommended for cavity sinking by electrical discharge machining.

**Joining** [32]. Molybdenum and molybdenum alloys can be welded and brazed but mechanical joining methods are widely used to avoid embrittlement.

**Welding.** Tungsten inert-gas welding (in gastight chambers filled with argon) and electron-beam welding are usually employed. The oxygen partial pressure must be extremely low

(< 0.5 Pa) because molten molybdenum rapidly takes up oxygen which leads to the precipitation of  $\text{MoO}_3$  on cooling and thus to pore formation.

Diffusion welding at a welding temperature slightly below the recrystallization temperature (1100 °C) is particularly suitable for workpieces that are to be subjected to high mechanical loading. Resistance welding is primarily used in the electron tube and lamp industries for joining thin wires, ribbons, and foils.

**Brazing** is a suitable alternative to welding for operating temperatures below 1400 °C. Since the thermal expansion coefficient of molybdenum is about the same as that of graphite, molybdenum-graphite composites with advantageous properties can be produced, particularly for applications in nuclear fusion research and aerospace. Amongst others AgCu, PdCu, PdAg, Zr, and Ti are used as brazing filler materials.

**Oxidation-Resistant Coatings** [33]. Molybdenum alloys that can withstand oxidizing conditions at high temperature are still not available. Oxidation resistance decreases drastically above 500 °C and above 600 °C significant loss of material occurs due to formation of volatile  $\text{MoO}_3$ . Owing to the increasing demand for high-temperature materials (e.g., in aerospace, turbine construction, and chemical reactors), oxidation-resistant coatings are being developed to permit the use of molybdenum materials in these applications.

**Table 27.1:** Uses of molybdenum and molybdenum alloys.

Area of application	Examples of uses
Lamp and lighting industries	support wires, sealing ribbons, dimming caps
Electronic and semiconductor industries	semiconductor base plates, heat sinks, contact pins, sputtering targets, control grids, klystron and travelling-wave tube components
High-temperature and vacuum furnace construction	heating elements, thermal radiation shields, furnace ware
Glass and ceramic industries	glass-melting electrodes, installations in glass production tanks, drawing dies, crucibles for producing sapphire single crystals
Casting technology and metalworking	forging dies for isothermal forging, extrusion dies, die-casting molds, hot-galvanizing equipment
Coating	spray wire, spray powder, evaporation boats, sputtering targets, components of chemical vapor deposition equipment
Nuclear technology	furnace parts and charging equipment for sintering $\text{UO}_2$ ; first wall, divertor, and limiter components for experimental fusion reactors
Medicine	rotating X-ray anodes, collimators

Coatings based on aluminides, silicides, ceramics (e.g.,  $\text{Al}_2\text{O}_3$ ,  $\text{ZrO}_2$ ), and metals (chromium, noble metals) have been studied. Coating processes such as dip alloying, electroplating, but primarily pack cementation and slurry techniques, as well as plasma spraying, physical vapor deposition, and chemical vapor deposition have all been used.

Coatings based on silicides (e.g.,  $\text{MoSi}_2$ , maximum use temperature 1600 °C) and complex silicides (e.g.,  $\text{SiCrFe}$ , maximum use temperature 1500 °C) provide the best protection against oxidation but are only effective for a limited period.

**Surface Hardening.** Nitriding, carburizing, and boriding have been increasingly used to increase the surface hardness and abrasion resistance of molybdenum materials. These thermochemical processes harden the surface to a depth of ca. 0.2 mm. Plasma-assisted processes are also becoming more important.

#### 27.4.8 Alloys [34–36]

Alloying with rhenium increases the strength and ductility, the latter effect is especially pronounced in alloys containing 40–50% rhenium. These alloys also have excellent welding properties.

Molybdenum-tungsten alloys are extremely resistant to molten zinc and are therefore used in zinc metallurgy for tanks, pipes, pumps, and stirrers.

## 27.5 Uses

Molybdenum is mainly used as an alloying element in steel, cast iron, and superalloys to increase hardenability, strength, toughness, and corrosion resistance. However, only the use of elemental molybdenum and molybdenum-base alloys is discussed in this section.

Initially, molybdenum was primarily used in the lamp industry. It is, however, now an increasingly important material in a wide range of applications (Table 27.1). In high-temperature applications, molybdenum competes with iron-, nickel-, and cobalt-base superalloys, ceramics, and other high-melting metals (tungsten, tantalum, and niobium). Superalloys can be used up to 1200 °C; molybdenum materials, especially the carbide-hardened alloys and molybdenum doped with potassium silicate, show adequate heat resistance (Figure 27.6) and creep properties up to 1800 °C. The lack of resistance to oxidation should, however, always be borne in mind. Molybdenum materials have a higher failure tolerance and ductility than ceramics and are less expensive than tantalum and niobium. Heating elements, thermal radiation shields, and furnace ware made of molybdenum are used, for example, in hot isostatic presses, sintering furnaces for the ceramic industry, and heat treatment furnaces.

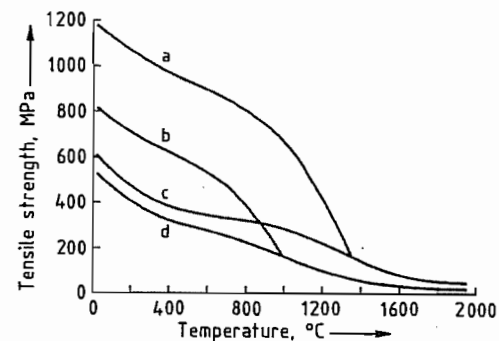

**Figure 27.6:** Tensile strengths of 1-mm thick molybdenum and TZM sheets as a function of temperature: a) TZM subjected to stress-relieving annealing; b) Molybdenum subjected to stress-relieving annealing; c) Recrystallized TZM; d) Recrystallized molybdenum.

Molybdenum is resistant to corrosion by most glasses and is therefore used as an electrode material in electric glass-melting furnaces. Glass produced in such furnaces is of better quality than that produced in fuel-fired furnaces and the process is more acceptable environmentally.

Crucibles and mandrels used to draw quartz glass or crucibles used for making single sapphire crystals have to withstand temperatures up to ca. 2100 °C. Molybdenum ribbon is used for electrical lead-in (e.g., in halogen lamps). In this application a vacuum-tight seal is formed by squeezing the quartz tubing around the ribbon at high temperature (ca. 2100 °C) and pressure. The high heat resistance of molybdenum and its low coefficient of thermal expansion are important prerequisites for these applications.

Electronic applications have and will continue to be a high-growth market for molybdenum parts. Molybdenum disks are used as base plates and heat sinks for power transistors and silicon rectifiers.

Molybdenum is also an important sputtering target material for electronic applications, mainly for codeposition of  $\text{MoSi}_x$  films from ultra-high-purity molybdenum and silicon targets. Integrated circuits employing these films have low parasitic capacitances and also low gate and interconnection propagation delays.

Molybdenum layers produced by thermal spraying possess exceptionally good sliding properties and high abrasion resistance. They are deposited on machine components, especially car engine parts such as piston rings, synchronizers, and selector forks.

More than 80% of the rotating X-ray anodes currently used in clinical diagnostics are made of molybdenum alloys. Loading can be increased by a thin tungsten rhenium layer on the molybdenum body. Rhenium in tungsten has the same effect on ductility as rhenium in molybdenum and decreases the susceptibility to cracking initiated by thermal stress. Brazing a thick graphite disk onto the back of a target increases its heat and emission capacity.

## 27.6 Compounds

As a transition element, molybdenum shows variable valency and forms many complexes and colored compounds. The outstanding feature of molybdenum is its chemical versatility: oxidation states from 2- to 6+, coordination numbers from 4 to 8 and, accordingly, a very varied stereochemistry; the ability to form compounds with most inorganic and organic ligands, with a particular preference for oxygen, sulfur, fluorine, and chlorine donor atoms; the formation of bi- and polynuclear compounds containing bridging oxide and chloride ligands and/or Mo-Mo bonds.

Molybdenum is very similar to tungsten, the third member of Group 6, but different from the first member, chromium. Molybdates(VI), unlike chromates(VI), are not strong oxidizing agents: much of the familiar chemistry of molybdenum is that of the 6+ and 5+ oxidation states.

In recent years research on molybdenum compounds has greatly increased because of their academic interest and their developing technical applications as lubricant additives (molybdenum disulfide and sulfur complexes), corrosion inhibitors, pigments, smoke suppressants, and heterogeneous catalysts (molybdenum trioxide and molybdates).

Recognition of the central role of molybdenum in a number of metalloenzymes (nitrogenase, nitrate reductase, xanthine oxidase) and the problem of molybdenum toxicity in ruminants have stimulated research in both molybdenum biochemistry and inorganic chemistry. The fact that molybdenum compounds are nontoxic to humans has led to interest in the possibility of replacing compounds of toxic metals with safer molybdenum compounds, e.g., chromium in corrosion inhibitors, anti-moym in flame and smoke suppressants.

For more background information on molybdenum chemistry, see [37-42].

**Compound Types.** Typical compounds of molybdenum(VI) are the trioxide,  $\text{MoO}_3$ ; sodium molybdate,  $\text{Na}_2\text{MoO}_4$ ; and ammonium

heptamolybdate,  $(\text{NH}_4)_6\text{Mo}_7\text{O}_{24}\cdot 4\text{H}_2\text{O}$  and  $(\text{NH}_4)_6\text{Mo}_7\text{O}_{24}\cdot 2\text{H}_2\text{O}$ . These compounds are the starting points for the preparation of many other molybdenum compounds. The chemistry of the higher oxidation states (4+ to 6+) is dominated by oxomolybdenum cations, e.g.,  $\text{MoO}^{2+}$ ,  $\text{Mo}_2\text{O}_4^{2+}$ ,  $\text{Mo}_2\text{O}_3^{4+}$ ,  $\text{MoO}^{3+}$ ,  $\text{MoO}_2^{2+}$ . The oxide ligands may be bound to just one molybdenum (terminal oxide) or to two or more molybdenum atoms (bridging) [43]. Replacement of one or more oxide ligands by sulfide has produced many molybdenum-sulfur complexes and clusters [44, 45].

The higher halides are covalent, e.g., molybdenum hexafluoride,  $\text{MoF}_6$ , and molybdenum pentachloride,  $\text{MoCl}_5$ .

Compounds of molybdenum(II) and lower oxidation states are stabilized by unsaturated ligands such as carbon monoxide, e.g., in molybdenum hexacarbonyl,  $\text{Mo}(\text{CO})_6$ , and by molybdenum-molybdenum bonds, and so are bi- or polynuclear, e.g., molybdenum(II) acetate,  $\text{Mo}_2(\text{CH}_3\text{COO})_4$ , and molybdenum(II) chloride,  $\text{Mo}_6\text{Cl}_{12}$ .

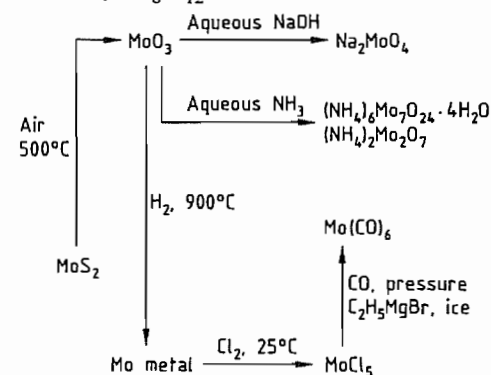

Figure 27.7: Relationship between some molybdenum compounds.

**Preparative Chemistry.** The starting point in preparative molybdenum chemistry is molybdenum(VI) oxide,  $\text{MoO}_3$  (Figure 27.7). Molybdenum disulfide, the naturally occurring form of molybdenum, is unreactive.

**Aqueous Solution Chemistry.** The aqueous chemistry of molybdenum is complicated [38]. It is dominated by oxo species which are prone to dimerize or polymerize. Hydrated

cations (i.e., cations having only water bound to molybdenum) are known only for oxidation states 2+ and 3+; they are powerful reducing agents which oxidize in air. The aqueous chemistry of molybdenum is summarized in Figure 27.8. The aqueous ion of molybdenum(IV) (not shown in Figure 27.8) is the red trimer,  $[\text{Mo}_3\text{O}_4(\text{H}_2\text{O})_9]^{4+}$ .

**Redox Chemistry.** Molybdenum exemplifies the general trend of a transition metal group; the higher oxidation states of the heavier elements (molybdenum and tungsten) are more stable (resistant to reduction) and the lower oxidation states less stable (more prone to oxidation) than those of the first element (chromium). Reduction potentials are summarized in Figure 27.9 [46]. Note that reduction in water bypasses molybdenum(IV).

For the reduction of molybdate in neutral or alkaline solution, sodium dithionite is useful, e.g., in the preparation of the molybdenum(V) cysteine complex,  $\text{Na}_2[\text{Mo}_2\text{O}_4\{\text{SCH}_2\text{CH}(\text{NH}_2)\text{COO}\}_2]\cdot 5\text{H}_2\text{O}$  [47].

Molybdenum(III) solutions oxidize rapidly in air and must be handled under nitrogen or argon. With molybdenum(V), aerial oxidation is slow. Titration of reduced molybdenum solutions with cerium(IV) sulfate or permangan-

ate is a volumetric method of determining molybdenum [48].

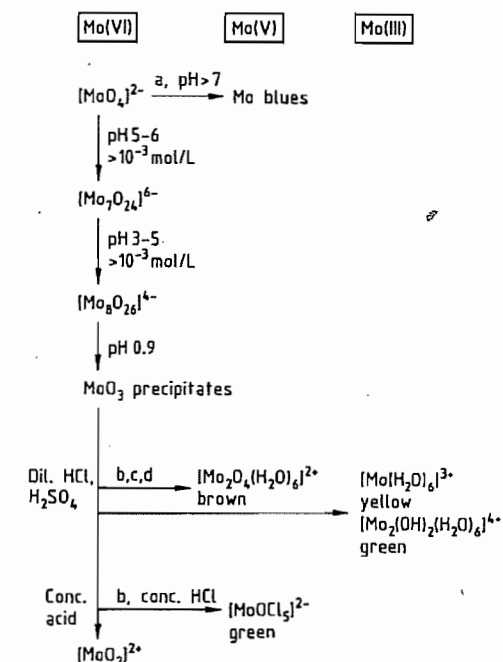

Figure 27.8: Aqueous chemistry of molybdenum showing species [38], reducing agents, and conditions. Reducing agents: a) Sodium dithionite,  $\text{Na}_2\text{S}_2\text{O}_4$ ; b) Hydrazinium hydrate,  $\text{N}_2\text{H}_4\cdot\text{H}_2\text{O}$ ; c) Tin(II) chloride; d) Liquid mercury.

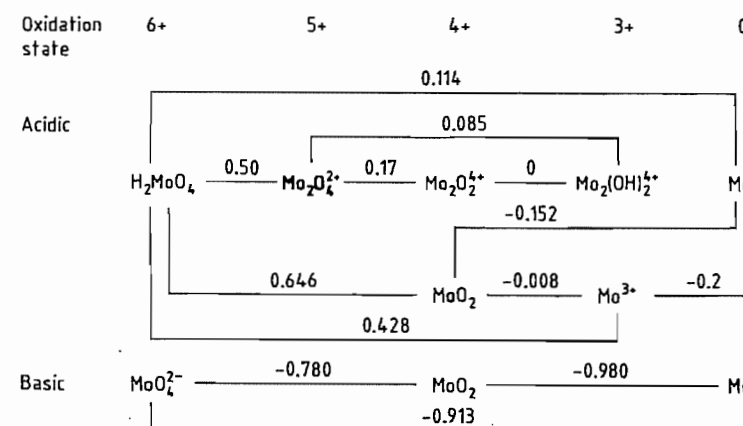

Figure 27.9: Reduction potentials (in volts) of molybdenum couples in acidic and alkaline aqueous solutions [46]. The more negative the potential, the more reducing is the couple, i.e., the more stable is the higher oxidation state.

**Table 27.2:** Properties of molybdenum trioxide and dioxide.

Property	MoO <sub>3</sub>	MoO <sub>2</sub>
Crystal structure	orthorhombic	monoclinic
Space group	<i>Pbnm</i>	<i>P2<sub>1</sub>c</i>
<i>Z</i>	4	4
<i>a</i> , nm	0.39628	0.56109
<i>b</i> , nm	1.3855	0.48562
<i>c</i> , nm	0.36964	0.56285
$\alpha, \beta, \gamma$	90°, 90°, 90°	90°, 120.95°, 90°
Mo coordination	octahedral, distorted	octahedral, distorted rutile
$\Delta H_f^\circ$ , kJ/mol <sup>a</sup>	-745.2	-588.7
$\Delta G_f^\circ$ , kJ/mol <sup>a</sup>	-667.9	-533.1
<i>S</i> <sup>o</sup> , J/K <sup>a</sup>	77.7	47.2
Density, g/cm <sup>3</sup> (21 °C)	4.692	6.29
<i>mp</i> , °C	801	
<i>bp</i> , °C	1155	
Sublimation, °C	ca. 700	ca. 1100
Solubility, g/L		
Water 28 °C	0.49	insoluble
100 °C	1.5	insoluble
HNO <sub>3</sub> (4 mol/L, 20 °C)	ca. 14	insoluble
Aqueous ammonia and alkali	soluble	insoluble
Organic solvents	insoluble	insoluble

<sup>a</sup> Standard enthalpy and free energy of formation from the elements and entropy at 298.15 K [49, 50].

### 27.6.1 Oxides

Well characterized oxides are molybdenum trioxide, MoO<sub>3</sub>, and molybdenum dioxide, MoO<sub>2</sub>. Mixed-valency oxides and molybdenum blues are also important.

**Molybdenum Trioxide.** Molybdenum trioxide, molybdenum(VI) oxide, MoO<sub>3</sub>, is the ultimate product of the oxidation of molybdenum compounds. It forms white orthorhombic crystals that are photosensitive, i.e., turn blue in light. The compound is weakly paramagnetic and an *n*-type semiconductor.

Other properties are listed in Table 27.2. It is produced by roasting molybdenum disulfide in air at 600 °C and may be purified by sublimation (see Section 27.4.2). It can also be prepared by reacting ammonium molybdate at 550 °C with oxygen or by precipitation from an aqueous ammonium molybdate solution treated with concentrated nitric acid [51].

The structure of molybdenum trioxide comprises layers built from linked, distorted MoO<sub>6</sub> octahedra. Crystal morphology depends on the method of preparation: needles occur after vapor condensation, platelets after crystal growth on silica or graphite [52]. Molybdenum trioxide has a characteristic IR spectrum showing Mo–O vibrations (996, 870, 821, and 570 cm<sup>-1</sup>).

Molybdenum trioxide is an acidic oxide soluble in aqueous alkali and ammonia. Freshly precipitated MoO<sub>3</sub>, which is much more reactive than the aged oxide, dissolves in aqueous solutions of citric, malic, and other hydroxycarboxylic acids [53], and in solutions of ethylene glycol, glycerol, and other polyols to form molybdenum(VI) complexes [54]. Molybdenum trioxide also reacts with  $\beta$ -diketones (e.g., acetylacetone) to form complexes such as MoO<sub>2</sub>(CH<sub>3</sub>COCHCOCH<sub>3</sub>)<sub>2</sub>, which is a useful starting compound for preparing other molybdenum(VI) complexes by ligand exchange reactions. It is reduced by hydrogen at 500–600 °C to MoO<sub>2</sub> and at 900–1000 °C to molybdenum metal.

Molybdenum trioxide in combination with more basic metal oxides finds application in heterogeneous catalysis. Studies of MoO<sub>3</sub> specimens with different crystal habits have demonstrated structure sensitivity of MoO<sub>3</sub> selective oxidation catalysts; the type of reaction catalyzed depends on the predominant crystal face. Platelike crystallites predominantly expose the (010) face which is responsible for insertion of oxygen into allylic compounds; activation of, for example, propene occurs at the (100) and (101) faces, and total oxidation at all faces [52].

**Hydrates of MoO<sub>3</sub>.** The monohydrate, MoO<sub>3</sub>·H<sub>2</sub>O, precipitates when a concentrated solution of sodium molybdate is acidified with hydrochloric acid. The dihydrate, MoO<sub>3</sub>·2H<sub>2</sub>O, precipitates when a solution of ammonium heptamolybdate is acidified with nitric acid [51]; it is commonly referred to as molybdic acid (H<sub>2</sub>MoO<sub>4</sub>·H<sub>2</sub>O). Both hydrates are yellow.

**Molybdenum Dioxide.** Molybdenum dioxide, molybdenum(IV) oxide, MoO<sub>2</sub>, is a dark blue crystalline solid and consists of chains of distorted MoO<sub>6</sub> octahedra. The distortions arise from Mo–Mo bonding leading to alternate long (0.31118 nm) and short (0.25106 nm) Mo–Mo distances [55, 56]. Properties are listed in Table 27.2. Molybdenum dioxide is a metallic conductor and is weakly paramagnetic. It is produced by reducing MoO<sub>3</sub> with hydrogen, ammonia, and carbon monoxide at 600 °C.

Molybdenum dioxide is a neutral oxide that is insoluble in acid and alkali. It reacts with chlorine giving dichlorodioxomolybdenum(IV), MoO<sub>2</sub>Cl<sub>2</sub>, and with carbon tetrachloride giving molybdenum tetrachloride, MoCl<sub>4</sub>.

**Molybdenum Blues.** Molybdenum blues, so called because of their blue color, are mixed oxide hydroxides of molybdenum(VI) and molybdenum(V) (Figure 27.8) [57]. They are amorphous solids that are soluble in water and alcohols. A typical species is (Mo<sub>3</sub><sup>5+</sup>Mo<sub>3</sub><sup>6+</sup>O<sub>18</sub>H)<sup>-</sup> which has an absorption maximum at 450 nm.

The formation of molybdenum blues is the basis of a colorimetric method for determining phosphorus [58]. Molybdate and orthophosphate ions condense in acidic solution to give molybdophosphoric acid which is reduced by hydrazinium sulfate to a molybdenum blue with maximum light absorbance at 820–830 nm. The color intensity is proportional to the amount of phosphate incorporated. The reduced molybdophosphate is an example of a heteropoly blue [57].

**Mixed Valency Oxides.** The mixed Mo(VI)–Mo(V) oxides (molybdenum oxide bronzes) have an intense color and metallic luster [59].

The binary bronzes MoO<sub>x</sub> (*x* between 2 and 3), constitute a series of deep blue or purple compounds. They are prepared by heating MoO<sub>3</sub> in vacuo or with molybdenum metal. The structures are built from edge- and corner-sharing [MoO<sub>6</sub>] octahedra, or [MoO<sub>6</sub>] octahe-

dra and [MoO<sub>4</sub>] tetrahedra. The Magneli phases, Mo<sub>4</sub>O<sub>11</sub>, and Mo<sub>8</sub>O<sub>23</sub>, have metallic properties at room temperature.

The ternary oxides include the red bronzes, A<sub>0.33</sub>MoO<sub>3</sub> (A = Li, K, Rb, Cs, Tl), which are semiconductors, the blue bronzes A<sub>0.3</sub>MoO<sub>3</sub> (A = K, Rb, Tl), purple bronzes A<sub>0.9</sub>Mo<sub>8</sub>O<sub>17</sub> (A = Li, Na, K, Tl), and a rare-earth bronze La<sub>2</sub>Mo<sub>2</sub>O<sub>7</sub>; they behave like metals at room temperature. Interest in these compounds is focused on their electrical and optical properties.

### 27.6.2 Chalcogenides

The most important chalcogenide of molybdenum is molybdenum disulfide, which is the principal source of molybdenum, in the form of the mineral molybdenite. Molybdenum selenide, MoSe<sub>2</sub>, and telluride, MoTe<sub>2</sub>, are also known.

**Molybdenum Disulfide.** Molybdenum disulfide, molybdenum(IV) sulfide, MoS<sub>2</sub>, is a black crystalline solid that occurs in two forms: hexagonal, which is found in the mineral molybdenite and rhombohedral (Table 27.3). The solid is diamagnetic and a semiconductor. It is built of S–Mo–S layers whose sulfur atoms are in contact (Figure 27.10). Within each layer molybdenum is at the centre of a trigonal prism of sulfur atoms. Since the forces operating between the layers are weak van der Waals attractions, the layers can slide over one another giving molybdenum disulfide a slippery texture and solid-state lubrication properties like graphite.

The hexagonal form is produced by heating molybdenum with sulfur, ammonium tetrathiomolybdate [(NH<sub>4</sub>)<sub>2</sub>MoS<sub>4</sub>], or molybdenum trisulfide at 1100 °C. The compound is amorphous at 250–400 °C; crystallization requires prolonged heating at 1100 °C. The rhombic form is obtained by heating the hexagonal form in vacuo at 7.5 GPa and 1200 °C, or by reacting MoO<sub>3</sub> with sulfur and potassium carbonate at 1100 °C.



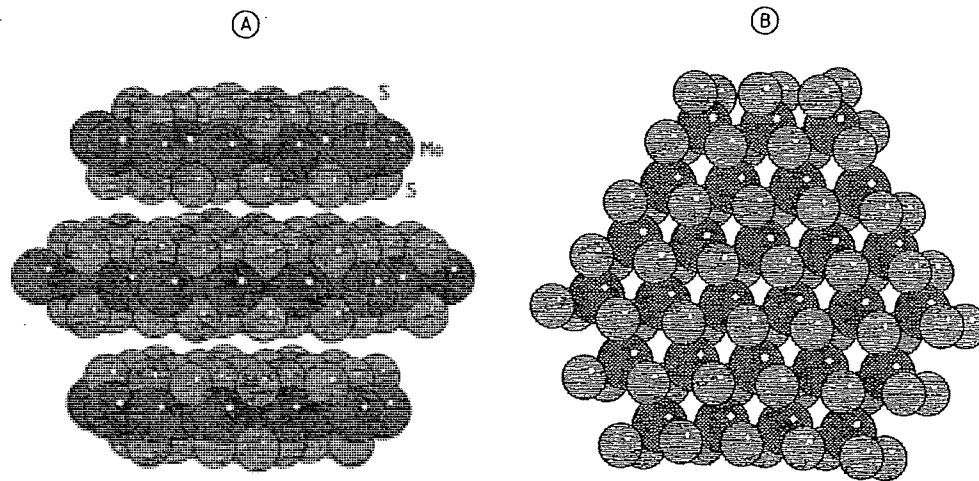

Figure 27.10: Structure of molybdenum disulfide. A) Side view showing the S-Mo-S layers; B) Top view of a hexagonal fragment of one layer.

Table 27.3: Properties of molybdenum disulfide.

Property	Hexagonal crystal structure	Trigonal prismatic structure
Space group	$P6_3/mmc, D_{6h}^3$	$R3m, C_{3v}^3$
Z	2	3
a, b, c, nm	0.316, 0.316, 1.229	0.317, 0.317, 1.838
$\alpha, \beta, \gamma$	$90^\circ, 90^\circ, 120^\circ$	$90^\circ, 90^\circ, 90^\circ$
Density, g/cm <sup>3</sup>	5.05	5.02
Mo coordination	trigonal prismatic	
Interatomic distances, nm		
Mo-S	0.242	
Mo-Mo	0.316	
S-S	0.349	
$\Delta H_f^\circ$ , kJ/mol <sup>a</sup>	-234.1	
$\Delta G_f^\circ$ , kJ/mol	-225.7	
$S^\circ$ , J/K	62.8	
mp, °C	> 1600	

<sup>a</sup> Standard enthalpy and free energy of formation from the elements and entropy at 298.15 K [49, 50, 60].

Molybdenum disulfide dissolves only in strongly oxidizing acids (e.g., aqua regia) to give molybdenum(VI) compounds. When heated in vacuo at 1200 °C it decomposes to Mo<sub>2</sub>S<sub>3</sub> and metallic molybdenum. Heating in air at 500 °C produces MoO<sub>3</sub>. Reduction with hydrogen at 1100 °C or > 1500 °C yields Mo<sub>2</sub>S<sub>3</sub> or molybdenum metal, respectively.

**Molybdenum Sesquisulfide.** Molybdenum sesquisulfide, dimolybdenum trisulfide, mo-

lybdenum(III) sulfide, Mo<sub>2</sub>S<sub>3</sub>, has a different structure from MoS<sub>2</sub>; the molybdenum is at the center of a distorted octahedron of sulfur atoms. Molybdenum sesquisulfide is a grey solid and is prepared by heating molybdenum and sulfur (2:3) in vacuo at 1400 °C. It dissolves in, and is oxidized to molybdenum(VI), by aqua regia. In air at 350 °C it oxidizes to molybdenum trioxide. Hydrogen at 1500 °C reduces it to molybdenum metal.

**Molybdenum Trisulfide.** Molybdenum trisulfide, molybdenum(VI) sulfide, MoS<sub>3</sub>, is the sulfide precipitated in conventional inorganic analysis when hydrogen sulfide is passed through an acidified molybdate solution. Molybdenum trisulfide, like the sulfides of tin, arsenic and antimony, dissolves in yellow ammonium sulfide giving a tetrathio salt, MoS<sub>4</sub><sup>2-</sup>.

According to X-ray absorption spectroscopy, the composition MoS<sub>3</sub> corresponds to Mo(S<sup>2-</sup>)<sub>2</sub>(S<sub>2</sub><sup>2-</sup>)<sub>0.5</sub>, one third of the sulfur is disulfide (S<sub>2</sub><sup>2-</sup>); the formal oxidation state of the molybdenum is 5+ [61].

When heated in nitrogen at ca. 350 °C molybdenum trisulfide decomposes to amorphous molybdenum disulfide. Heated in air, it begins to oxidize to molybdenum trioxide at 200 °C.

**Chevreil Phases.** The Chevreil phases are ternary molybdenum chalcogenides, M<sub>x</sub>Mo<sub>6</sub>X<sub>8</sub> (where M is a metal and X a chalcogenide), for example, PbMo<sub>6</sub>S<sub>8</sub> [62]. They are black powders prepared by heating the constituent elements in vacuo at 1000 °C. They consist of linked [Mo<sub>6</sub>S<sub>8</sub>] clusters having sulfur atoms at the corners of a cube and molybdenum atoms at the face centers (the same structure as the [Mo<sub>6</sub>Cl<sub>8</sub>] structure). These compounds have attracted great interest as superconductors with critical temperatures as high as 15 K and as battery materials.

**Ammonium Tetrathiomolybdate.** Ammonium tetrathiomolybdate, (NH<sub>4</sub>)<sub>2</sub>[MoS<sub>4</sub>], crystallizes from a solution of ammonium molybdate saturated with hydrogen sulfide to form deep red crystals. The [MoS<sub>4</sub>]<sup>2-</sup> ion is tetrahedral and is the thio analogue of molybdate. Ammonium tetrathiomolybdate has an extensive chemistry and is an entry point to much molybdenum sulfur chemistry. The sulfur atoms form bridges to metal ions so forming clusters, e.g., the species [S<sub>2</sub>MoS<sub>2</sub>CoS<sub>2</sub>MoS<sub>2</sub>]<sup>2-</sup> with Co<sup>2+</sup> [38].

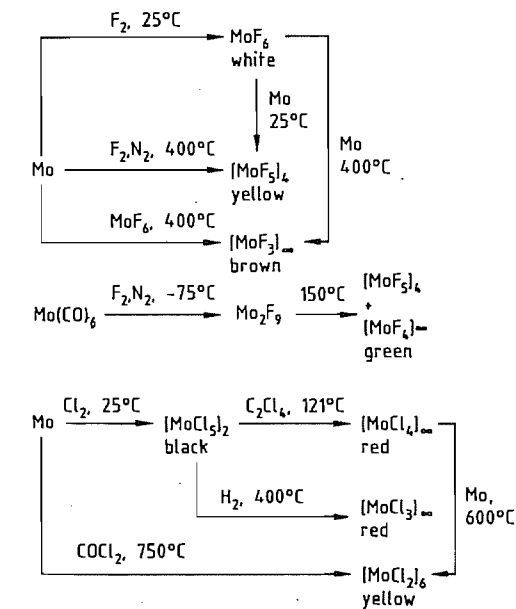

Figure 27.11: Preparation of molybdenum fluorides and chlorides.

## 27.6.3 Halides

Binary halides are known for molybdenum in oxidation states (II) to (VI). The preparation of molybdenum fluorides and chlorides is summarized in Figure 27.11. The only molecular halide is molybdenum hexafluoride, MoF<sub>6</sub>, which is a volatile liquid. The coordination number of molybdenum is six in the halides of Mo(V), (IV), and (III), the molybdenum atoms being linked by bridging halogens.

Molybdenum(II) chloride is an extended solid containing [Mo<sub>6</sub>Cl<sub>8</sub>]<sup>4+</sup> clusters linked by bridging chlorines so giving the formula Mo<sub>6</sub>Cl<sub>12</sub>. In the cluster eight chlorine atoms are at the corners of a cube. Molybdenum atoms, linked by Mo-Mo bonds, are at the face centers of the cube and so constitute an octahedral Mo<sub>6</sub> cluster. The cluster is very stable both to hydrolysis and oxidation and persists through many reactions.

A feature of the halides of Mo(IV), (III), and (II) is the formation of bonds between molybdenum atoms. Consequently, there is pairing of electron spins on adjacent molybdenum atoms and so the magnetic moments of the halides are less than the spin-only values.

**Molybdenum Pentachloride.** Molybdenum pentachloride, molybdenum(V) chloride, MoCl<sub>5</sub>, is the most important molybdenum halide. The dark green black crystals (mp 194 °C) consist of Mo<sub>2</sub>Cl<sub>10</sub> dimers; the vapor and solutions contain MoCl<sub>5</sub> monomers.

Molybdenum pentachloride is soluble in carbon tetrachloride, benzene, and many other organic solvents. It is very reactive, undergoing hydrolysis in air, water, and damp organic solvents to form brown oxomolybdenum(V) chlorides. It is supplied and stored in sealed ampoules and must be handled under argon or nitrogen or in vacuo.

The outstanding property of molybdenum pentachloride is its ability to abstract an oxygen atom from water, sulfur dioxide, triphenylphosphine oxide (Ph<sub>3</sub>PO), dimethyl sulfoxide (Me<sub>2</sub>SO), and other oxygen-containing compounds to form oxomolybdenum complexes, MoOCl<sub>3</sub>A<sub>2</sub>, (e.g., A = Ph<sub>3</sub>PO,

Me<sub>2</sub>SO). In concentrated hydrochloric acid molybdenum pentachloride forms the deep green complex ion [MoOCl<sub>5</sub>]<sup>2-</sup>.

Molybdenum pentachloride is the starting point for much nonaqueous and organomolybdenum chemistry.

**Oxomolybdenum Halides.** In oxidation states 5+ and 6+ molybdenum has a strong tendency to form multiple bonds to oxygen. The oxomolybdenum halides are volatile solids which may be sublimed in vacuo. They are more stable than the binary halides and are formed when the binary halides are exposed to air and water.

Oxomolybdenum(VI) compounds are of two types: MoOX<sub>4</sub> (X = F, Cl), and MoO<sub>2</sub>X<sub>2</sub> (X = F, Cl, Br). Oxomolybdenum(V) compounds are generally monoxo, e.g., MoOCl<sub>3</sub>.

**Trichlorooxomolybdenum(V).** Trichlorooxomolybdenum(V), MoOCl<sub>3</sub>, is a green solid consisting of octahedral [MoOCl<sub>5</sub>] units linked through cis-chlorine atoms. It forms adducts with many organic ligands, e.g., MoOCl<sub>3</sub>L (L = ligand) with acetylacetone and

2,2'-bipyridyl, and MoOCl<sub>3</sub>·2L with diethyl ether and pyridine.

### 27.6.4 Molybdates, Isopolymolybdates, and Heteropolymolybdates

Sodium molybdate and other simple molybdates contain the tetrahedral [MoO<sub>4</sub>]<sup>2-</sup> ion. Ammonium heptamolybdate (an isopolymolybdate), (NH<sub>4</sub>)<sub>6</sub>Mo<sub>7</sub>O<sub>24</sub>·4H<sub>2</sub>O, is composed of linked, distorted [MoO<sub>6</sub>] octahedra. In the heteropolymolybdates, molybdenum and another element are present in the same structure. The properties of some of the more important molybdates are summarized in Table 27.4.

**Ammonium and Alkali-Metal Molybdates.** Ammonium and alkali-metal molybdates are soluble in water (Table 27.4). They are made by crystallizing or evaporating solutions of molybdenum trioxide dissolved in aqueous alkali. Ammonium dimolybdate is used as an intermediate for purifying technical-grade MoO<sub>3</sub>.

Table 27.4: Properties of some molybdates [39, 63].

Molybdate	M <sub>r</sub>	Structure <sup>a</sup>	Color	Solubility in water, % <sup>b</sup>	ΔH <sub>f</sub> <sup>0</sup> , kJ/mol <sup>c</sup>
(NH <sub>4</sub> ) <sub>2</sub> MoO <sub>4</sub>	196.01	4	white	39	
(NH <sub>4</sub> ) <sub>2</sub> Mo <sub>2</sub> O <sub>7</sub>	339.95	4 or 6		30	
(NH <sub>4</sub> ) <sub>6</sub> Mo <sub>7</sub> O <sub>24</sub> ·4H <sub>2</sub> O	1235.8	6	white	30	
Na <sub>2</sub> MoO <sub>4</sub>	205.92	6 + 4	white	40	-1466
MgMoO <sub>4</sub>	184.24	6 + 6	white	16	-1248
CaMoO <sub>4</sub>	200.01	8 + 4	white	0.005	-1548
SrMoO <sub>4</sub>	247.56	8 + 4	white	0.003	-1449
BaMoO <sub>4</sub>	297.26	8 + 4	white	0.005	-562
CoMo <sub>4</sub> <sup>d</sup>	218.87				-1032
a		6 + 4	violet		
b		6 + 6	rose		
NiMoO <sub>4</sub> <sup>d</sup>	218.63				-947.7
a		6 + 4	green		
b		6 + 6	green		
PbMoO <sub>4</sub>	367.14	8 + 4	white	10 <sup>-5</sup>	-1076
ZnMoO <sub>4</sub>	225.33	5 or 6 + 4	white	0.5	-1140
Fe <sub>2</sub> (MoO <sub>4</sub> ) <sub>3</sub>	591.50	6 + 4	yellow		-2963

<sup>a</sup> Coordination of the counterion (except ammonium) by oxide and coordination of molybdenum (4 = tetrahedral; 6 = octahedral).

<sup>b</sup> Weight percent of anhydrous salt in 100 g saturated solution at 25 °C.

<sup>c</sup> Standard heat of formation from the elements at 298.15 K.

<sup>d</sup> Two polymorphs: low-temperature form, b, transforms to the high-temperature form, a, at 400 °C [64].

Ammonium molybdates are made by dissolving MoO<sub>3</sub> in aqueous ammonia solution; (NH<sub>4</sub>)<sub>2</sub>MoO<sub>4</sub> then crystallizes from aqueous ammonia, (NH<sub>4</sub>)<sub>6</sub>Mo<sub>7</sub>O<sub>24</sub>·4H<sub>2</sub>O from a solution kept at the boiling point for 1 h, and (NH<sub>4</sub>)<sub>6</sub>Mo<sub>8</sub>O<sub>26</sub>·5H<sub>2</sub>O from an acidified aqueous solution of (NH<sub>4</sub>)<sub>6</sub>Mo<sub>7</sub>O<sub>24</sub>·4H<sub>2</sub>O. The dimolybdate, (NH<sub>4</sub>)<sub>2</sub>Mo<sub>2</sub>O<sub>7</sub>, may be crystallized from hot ammoniacal molybdate solutions.

The structures of the isopolymolybdates are based on linked, distorted [MoO<sub>6</sub>] octahedra. The structure of ammonium dimolybdate consists of infinite chains of pairs of edge-shared [MoO<sub>6</sub>] octahedra with adjacent pairs linked by [MoO<sub>4</sub>] tetrahedra [65].

Ammonium di- and heptamolybdates are used as sources of water-soluble molybdenum, for example, in the preparation of catalysts. When the catalyst is calcined, the molybdate decomposes to molybdenum trioxide and ammonia.

**Molybdates of Di- and Trivalent Cations.** Molybdates of divalent cations (except Mg<sup>2+</sup>) are insoluble in water (Table 27.4). They are prepared by precipitation from a sodium or ammonium molybdate solution or by heating mixed solid oxides. The coordination environment of the molybdenum may be tetrahedral or octahedral.

Molybdates of trivalent cations have the formula A<sub>2</sub>(MoO<sub>4</sub>)<sub>3</sub> or A<sub>2</sub>Mo<sub>3</sub>O<sub>12</sub>, with A = Al, Cr, Fe, Bi, lanthanide. Coordination of the molybdenum is tetrahedral; the other cation is usually octahedral.

A number of these molybdates have important uses. Cobalt, iron, and bismuth molybdates are catalysts for the selective oxidation of organic compounds: olefins are oxidized to unsaturated aldehydes and ketones, e.g., propene to acrolein (cobalt and bismuth), propene and ammonia to acrylonitrile (bismuth), methanol to formaldehyde (iron). Molybdenum is the source of selectivity in these reactions. The first step is generally activation of a C-H bond over the more basic (nonmolybdenum) oxide and the molybdenum then controls oxygen insertion. The well known Co-Mo/alumina hy-

drodesulfurization catalyst does not, however, strictly contain cobalt molybdate.

Other actual or proposed applications are: calcium and strontium molybdates doped with neodymium as lasers; lanthanide molybdates for optical and optoelectric applications; zinc molybdate as a white pigment and corrosion inhibitor.

**Heteropolymolybdates.** The heteropolymolybdates consist of [MoO<sub>6</sub>] octahedra incorporating atoms of a different element, the heteroatom [38, 66]. The heteroatoms are completely surrounded by the oxygen atoms of the [MoO<sub>6</sub>] octahedra. The resulting coordination of the heteroatom may be tetra- or octahedral. The 12-molybdo species, [X<sup>n+</sup>Mo<sub>12</sub>O<sub>40</sub>]<sup>(8-n)-</sup>, is an important group with tetrahedrally coordinated heteroatoms (X). An example is 12-molybdophosphoric acid, H<sub>3</sub>[PMo<sub>12</sub>O<sub>40</sub>]·28H<sub>2</sub>O, prepared by dissolving molybdenum trioxide in phosphoric acid; it is yellow and readily soluble in water. Ammonium 12-molybdophosphate, which precipitates when ammonium molybdate is added to a solution of disodium hydrogen phosphate, is used for the gravimetric determination of phosphate [62]. The phosphomolybdates are selective oxidation catalysts, e.g., in the conversion of acrolein to acrylic acid [67].

### 27.6.5 Other Compounds

Molybdenum forms a large number of coordination compounds or complexes [38]. Complexes with organosulfur ligands attract a great deal of current interest because of their significance in molybdenum biochemistry and applications as oil-soluble antiwear and friction-reducing additives [68]. Examples of the latter are phosphorodithioates (dithiophosphates) and dithiocarbamates, [Mo<sub>2</sub>O<sub>3</sub>L<sub>4</sub>] and [Mo<sub>2</sub>O<sub>2</sub>S<sub>2</sub>L<sub>2</sub>] where L is (RO)<sub>2</sub>PS<sub>2</sub><sup>-</sup>, R<sub>2</sub>NCS<sub>2</sub><sup>-</sup>.

Molybdenum hexacarbonyl, Mo(CO)<sub>6</sub>, mp 150 °C, bp 156.4 °C (sublimes), is a white, air-stable solid that is insoluble in water but soluble in organic solvents. It is made from molybdenum pentachloride (Figure 27.7) and is commercially available. It is a starting point for the synthesis of low-valent and organomo-

lybdenum compounds [69]. The structure consists of CO groups octahedrally disposed around molybdenum and bound through carbon.

## 27.7 Uses of Molybdenum Compounds

Molybdenum-containing catalysts are used for a broad range of reactions [76]. In some cases, the catalyst is a single molybdenum compound, and either soluble (homogeneous) or insoluble (heterogeneous) in the reaction medium. In other cases, the catalyst is a binary mixture of the oxides and/or sulfides of molybdenum and of another element (usually Co, Ni, Fe, W, or Bi). The catalytic properties of these binary compositions differ greatly from those of the individual compounds. The heterogeneous catalysts are often formed and supported on a substrate such as activated alumina, silica, carbon, or zeolite. The support can greatly improve catalyst activity, selectivity, and mechanical strength. In industrial practice other elements or compounds (e.g., potassium, phosphorus, tungsten, or silica) are often added to the binary compositions as additives to further enhance activity, selectivity, and strength.

The scope and versatility of molybdenum catalysts are illustrated in Table 27.5 [77]. The activity and selectivity of catalysts based on MoO<sub>3</sub> and MoS<sub>2</sub> are summarized for redox reactions; isomerization, polymerization, addition, and decomposition (usually classified as acid base reactions).

One of the largest uses for molybdenum catalysts is in the desulfurization of petroleum, petrochemicals, and coal-derived liquids, in which organosulfur compounds react with hydrogen at the catalyst surface and sulfide ions are removed as hydrogen sulfide. Desulfurization is used to improve product color, smell, and stability, to eliminate sulfur dioxide emission on fuel combustion, and to make possible subsequent reforming processes which may use sulfur-sensitive cata-

lysts. Today, environmental air quality is a major reason for desulfurization.

The most common desulfurization catalyst is a binary mixture of cobalt oxide and an excess of molybdenum trioxide on an activated alumina substrate. After being charged into the industrial reactor, the catalyst reacts with the sulfur-containing reducing atmosphere to form molybdenum and cobalt sulfides as the working catalyst. A major development in the history of hydrocarbon oxidation was the discovery of bismuth molybdate catalysts for the partial oxidation and ammoxidation of propene to acrylonitrile in one step [78].

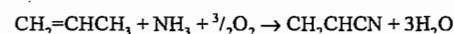

The original catalyst was reported to have a composition of 50% Bi<sub>2</sub>PbMo<sub>12</sub>O<sub>52</sub> and 50% SiO<sub>2</sub>, with the silica gel support preventing catalyst disintegration in the fluidized bed operation. This catalyst and its modifications account for virtually all of the acrylonitrile production in the world.

Another major catalyst based on ferric molybdate (5MoO<sub>3</sub>·Fe<sub>2</sub>O<sub>3</sub>) is used to selectively oxidize methanol to formaldehyde [79]:

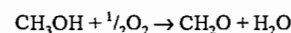

Molybdenum catalysts are also important in commercial coal liquefaction processes where coal is converted into upgraded liquid fuels. Coal liquefaction processes commonly utilize either alumina-supported cobalt molybdate or molybdenum trioxide as catalyst to effect desulfurization, denitrogenation, deoxygenation, cracking, and hydrogenation.

Phosphomolybdate compounds are acidic oxidants and are used in both homogeneously and heterogeneously catalyzed processes such as the hydration of propene in liquid phase and the oxidation of isobutyric acid to methacrylic acid.

Molybdenum hexacarbonyl is a versatile homogeneous and heterogeneous catalyst. It is widely used in the production of methanol from carbon monoxide, to effect olefin metathesis, desulfurization, aqueous coal liquefaction, and epoxidation.

Table 27.5: Reactions catalyzed by molybdenum oxides and sulfides [77].

Type of reaction	Example	Catalyst	Temperature range, °C	Conversion, %	Selectivity, %
<b>Reactions with molecular hydrogen</b>					
Isotropic exchange	H <sub>2</sub> + D <sub>2</sub> → 2HD	MoO <sub>3</sub> /Al <sub>2</sub> O <sub>3</sub> -SiO <sub>2</sub>	80		very high
Hydrogenation	benzene → cyclohexane	MoO <sub>3</sub>	420-450	60	
	acetylene → ethylene	MoO <sub>3</sub> -CoCl <sub>2</sub> /SiO <sub>2</sub>	260-300		100
	naphthalene → decalene	MoS <sub>2</sub>	340		yield 77
	sulfur → hydrogen sulfide	MoS <sub>2</sub>	200	100	
	selenium → hydrogen selenide	MoS <sub>2</sub>	330-350	100	
	maleic anhydride → succinic anhydride	CuMoO <sub>4</sub> /SiO <sub>2</sub>	120-160	100	
Hydrogenolysis	α- and β-methyl naphthalene → naphthalene + methane	CoO-MoO <sub>3</sub> /Al <sub>2</sub> O <sub>3</sub>			yield 40
	ethylcyclohexane → products	MoO <sub>3</sub> /Al <sub>2</sub> O <sub>3</sub>	510		
	phenol → benzene + H <sub>2</sub> O	MoS <sub>2</sub>	350		yield 88-98
Reduction	thiophenol → benzene + H <sub>2</sub> S	MoS <sub>2</sub>	200	100	
	thiophene → C <sub>4</sub> H <sub>10</sub> + H <sub>2</sub> S	MoS <sub>2</sub>	300	98	
	C <sub>4</sub> H <sub>8</sub> C <sub>4</sub> H <sub>6</sub> organic sulfur compounds → hydrocarbons	CoO-MoO <sub>3</sub> /Al <sub>2</sub> O <sub>3</sub>	225-425		
<b>Reactions with molecular oxygen</b>					
Selective oxidation	propene → acrolein	Bi <sub>2</sub> O <sub>3</sub> -MoO <sub>3</sub>	450	95	95
	butene → maleic anhydride	CoO-MoO <sub>3</sub> -P <sub>2</sub> O <sub>5</sub> /Al <sub>2</sub> O <sub>3</sub>	450	76	50
	benzene → maleic anhydride	V <sub>2</sub> O <sub>5</sub> -MoO <sub>3</sub> -P <sub>2</sub> O <sub>5</sub> /Al <sub>2</sub> O <sub>3</sub>	425-450		85
	<i>o</i> -xylene → phthalic anhydride	V <sub>2</sub> O <sub>5</sub> -MoO <sub>3</sub>	400		48
Oxidation of functional groups	methanol → formaldehyde	Fe <sub>2</sub> (MoO <sub>4</sub> ) <sub>3</sub>	300-400	92	92
	acrolein → acrylic acid	CoO-MoO <sub>3</sub> -TeO <sub>2</sub>	383	85	65
Oxidative condensation	propene + NH <sub>3</sub> → acrylonitrile	Bi <sub>2</sub> O <sub>3</sub> -MoO <sub>3</sub>	400-500		yield 80
	toluene + NH <sub>3</sub> → benzonitrile	V <sub>2</sub> O <sub>5</sub> -MoO <sub>3</sub> /Al <sub>2</sub> O <sub>3</sub>	415		yield 94
Oxidative dehydrogenation	butene → butadiene	Bi <sub>2</sub> O <sub>3</sub> -MoO <sub>3</sub>	370-550		90
	ethylbenzene → styrene	MoO <sub>3</sub> -MgO	420-450		82-84
Oxyhydration	propene → acetone	SnO <sub>2</sub> -MoO <sub>3</sub>	135		85
Oxidative dehydrocondensation	<i>n</i> -butane + SO <sub>2</sub> → thiophene	MoO <sub>3</sub> /Al <sub>2</sub> O <sub>3</sub>	595	70	44
	butene + H <sub>2</sub> S → thiophene	CoO-MoO <sub>3</sub> /Al <sub>2</sub> O <sub>3</sub>	570		yield 37
<b>Oxidation with other oxidants</b>					
Epoxidation	propene + H <sub>2</sub> O <sub>2</sub> → propylene oxide	MoO <sub>3</sub> in H <sub>2</sub> O <sub>2</sub> and pyridine	60	80	100
<b>Isomerization</b>					
Structural isomerization	<i>n</i> -pentane → isopentanes	MoO <sub>3</sub> /Al <sub>2</sub> O <sub>3</sub>	425-450	50	95
Ring concentration	cyclohexane → methylcyclopentane	MoO <sub>3</sub> /Al <sub>2</sub> O <sub>3</sub>	455-495		yield 37
<b>Disproportionation</b>					
Olefin metathesis	propene → butene + ethylene	MoO <sub>3</sub> /Al <sub>2</sub> O <sub>3</sub>	66-288	43	94
Polymerization	ethylene → polyethylene	MoO <sub>3</sub> /Al <sub>2</sub> O <sub>3</sub>	200-260	50	
	acetylene → benzene	CoO-MoO <sub>3</sub> /Al <sub>2</sub> O <sub>3</sub>	62	98	100
<b>Etherification</b>					
Formation of complex ethers	succinic acid + hexanol → ether	MoS <sub>2</sub> /carbon	130-220	45-97	100
<b>Addition to C=C</b>					
Decomposition	allylic alcohol + H <sub>2</sub> O <sub>2</sub> → glycerol	MoO <sub>3</sub> in acetic acid	70-100		
<b>Dehydration</b>					
Dehydration	2-propanol → propene	MoO <sub>3</sub>	191-224		100
	ammonium benzoate → benzonitrile	MoO <sub>3</sub>	225-245		
Dehydrogenation	ethylbenzene → styrene	MoS <sub>2</sub>	414		yield 94
	cyclohexane → benzene	MoO <sub>3</sub> /Al <sub>2</sub> O <sub>3</sub>	500		yield 63
Dehydrocyclization	<i>n</i> -heptane → toluene	MoO <sub>3</sub> /Al <sub>2</sub> O <sub>3</sub>	450-500		yield 75
Dehydrocondensation	isobutene → xylenes	MoO <sub>3</sub> /Al <sub>2</sub> O <sub>3</sub>	200		yield 90

### 27.7.1 Lubrication

Molybdenum disulfide is an important solid lubricant, being used primarily to reduce wear, friction, and sustain lubrication under boundary sliding conditions. It is a black powder that is insoluble in ordinary aqueous and organic solvents but dissolves by complex formation in potassium cyanide, and reacts with strong oxidizing agents such as aqua regia or hot concentrated sulfuric acid to give hexavalent molybdenum species. It is an excellent high-temperature lubricant which is stable in vacuo or an inert atmosphere to 1200 °C, and to about 350 °C in air.

The primary commercial source for MoS<sub>2</sub> is the mineral molybdenite, from which > 98% pure powder is recovered and purified using oil flotation and other techniques with carbon being the major impurity. The lubricating powder is available in several grades based on its median particle size which may range from ca. 1 to 40 μm.

The crystal structure of natural MoS<sub>2</sub> is hexagonal (Figure 27.10). Its excellent intrinsic lubricating properties are attributed to the wide spacing and weak van der Waals bonding between the S–Mo–S sandwich layers, and to the net positive charge on the surface which promotes easy shear by means of electrostatic repulsion [80]. This intrinsic lubricating quality contrasts with graphite, which requires the presence of condensable vapors (e.g., from water or hydrocarbons) to promote crystal cleavage and low friction [81].

The fundamental and practical aspects of MoS<sub>2</sub> lubrication are reviewed in [73, 82, 83]. Molybdenum disulfide is sometimes simply rubbed on surfaces as a thin film to provide short-term lubrication. As an additive, it enhances the performance of other lubricants like grease or oil. It can also be incorporated into paint-like coatings for longer service life. Finally, it can be incorporated into plastics, rubber, and powder metal matrices as an alternative to conventional lubricants to impart lifetime self-lubrication.

Summaries have been published describing the use of MoS<sub>2</sub> in greases [84], rubber

[85], bonded coatings [86], and motor oils [87].

The largest consumption of MoS<sub>2</sub> is in greases used in mining, manufacturing, and transportation [84]. In greases, 1–20% molybdenum disulfide gives added protection from wear and galling, and provides back-up lubrication should the grease deplete or thermally degrade. Pastes composed of grease and containing 20–60% MoS<sub>2</sub> are used with open gears, universal joints, spline drives, and in metal forming, press-fitting and various wear-in operations. They have outstanding boundary lubrication behavior which prevents fretting, galling, and seizing.

As an extra-fine powder, MoS<sub>2</sub> (0.5–1%) is suspended in *industrial oils, motor oils, and synthetic fluids*, with the aid of chemical dispersants such as polyethylene where it behaves as an extreme-pressure and antiwear additive. In motor oils, it also improves vehicular fuel economy.

*Paint-like coatings* containing 30–85 vol% MoS<sub>2</sub> in either an organic or inorganic silicate binder are used on fasteners, machine tools, forklift chains, door locks, chutes, and sliding parts of office equipment to reduce friction and wear. Temporary coatings of MoS<sub>2</sub> in water-soluble binders (e.g., poly(vinyl alcohol) and polyacrylates) are used in die casting as a mold release, and in metal forming operations such as ironing, wire drawing, and extrusion.

In *plastic, rubber, and powdered metal compositions*, 0.5–4% MoS<sub>2</sub> imparts self-lubricating behavior obviating the requirement for externally applied lubrication. These materials are used in articles such as cams, thrust washers, ball bearing retainers, compressor piston rings, sheaves, gears, conveyor belting, and dynamic seals.

Molybdenum disulfide is not the only molybdenum compound used in lubrication. *Oil-soluble molybdenum-sulfur compounds* have also long been used as antiwear and extreme-pressure additives in lubricating oils and greases [88]. Commercial oil-soluble additives are compositions based on tetrathiomolybdates and complexes of molybdenum with xanthates, dithiocarbamates, dithiophos-

phates, diketones, dithiols, and dimercaptodithiazoles [88].

### 27.7.2 Corrosion Inhibition

In 1939, two patents first described the use of readily soluble sodium, potassium, and ammonium molybdates as corrosion inhibitors for motor vehicle engine coolants [89, 90]. These and other inorganic molybdates are now among the most popular corrosion inhibitors because of their favorable properties and behavior. Molybdate is an anodic inhibitor, i.e., it inhibits by increasing the polarization of the anode component of the metal corrosion cell. It does this by precipitating escaping metal cations as molybdate species to block anodic sites and strengthen developing metal oxide films. Molybdate inhibits the corrosion of more ferrous and nonferrous metals over a wider pH range than any other inhibitor apart from chromate. Unlike chromate, however, the simple molybdate anion is not an oxidant and thus can be used with chemicals and systems that do not tolerate the strongly oxidizing chromate. Of even greater importance, molybdate has a very low toxicity. The toxicity, environmental aspects, behavior, mechanistic studies, and many applications of the molybdates are reviewed in [91, 92].

Molybdates are seldom used alone—as with other anodically active inhibitors, molybdate efficacy is improved and its concentration requirement significantly reduced when it is combined with other inhibitors. The most widely employed synergists of molybdate inhibition are the cathodically active compounds, especially zinc salts (e.g., zinc sulfate). Other synergists are the oxidizing inhibitors (e.g., nitrite) and the filming inhibitors (e.g., amine phosphonates and hydroxyfatty acids) [92]. Filming inhibitors strongly adsorb to the metal surface and protect it from attack.

Sodium molybdate is a component of many of the factory-fill and after-market engine coolants used in the United States, Europe, and Japan. A modern engine coolant concentrate formulation containing molybdate and

other inhibitors is as follows [93] (concentrations in weight percent):

Ethylene glycol	95.56
Sodium nitrate	0.10
Sodium molybdate dihydrate	0.20
Sodium tetraborate pentahydrate	0.40
Sodium silicate solution N <sup>1</sup>	0.30
Phosphoric acid 85%	0.15
Sodium mercaptobenzothiazole, 50% solution	0.50
Sodium tolyltriazole, 50% solution	0.20
Sodium hydroxide	0.235
Water	2.30
Polyglycol	0.05
Dye	0.005

The largest consumption of molybdates for corrosion inhibition is in the treatment of cooling water in open and closed recirculating cooling systems. Open systems include cooling tower waters associated with power generation, manufacturing operations, and with metals production and chemicals processing. A formulation of a corrosion inhibition treatment in an open cooling tower system (milligrams per liter) follows:

1-hydroxyethylidene-1,1-diphosphonic acid, 60% solution	10
Sodium molybdate dihydrate	10
Zinc sulfate monohydrate	2
Sodium tolyltriazole, 50% solution	2

Closed loop waters are used in stationary power engines, in refrigeration and humidity control, and in chilled-water air conditioning; a formulation of a corrosion inhibition treatment for a closed chilled-water air conditioning system (milligrams per liter) follows:

Sodium molybdate dihydrate	150
Sodium nitrite	150
Sodium tolyltriazole, 50% solution	4

Not only the highly soluble sodium, potassium, lithium, and ammonium molybdate salts are used in corrosion inhibition; the very slightly soluble zinc, strontium, and calcium molybdates are effective corrosion-inhibiting pigments in primer paints for steel and aluminum [94]. The pure compounds are no longer used; they have been replaced by equally and, in some cases, more effective pigments made by precipitating the pure compounds on less expensive, synergistic core materials such as zinc oxide, calcium carbonate, talc, or zinc phosphate [95–97].

<sup>1</sup> Registered trademark of PQ Corp., Valley Forge, PA.

Other products and processes which utilize molybdates as corrosion inhibitors include water-based hydraulic and metalworking fluids, lithium halide refrigerating brines, boiler waters, hot forging lubricants, aluminum anodizing processes, coal water slurries, temporary rust-preventive coatings, rinses for phosphate conversion coating, oil field drilling muds, brake linings, water used for quenching after heat treatment, paint-spray water curtains, wet ball milling of ores, salt brines for ice-making, passivation treatments for galvanized zinc and tin plate, packaging paper and board used for metal parts, temporary coating of aluminum to prevent staining by water during storage and transport, and as a pitting inhibitor for stainless steels in mineral acids. These and other applications are reviewed in [92].

### 27.7.3 Flame Retardancy and Smoke Suppression

Treatments based on molybdenum compounds exhibit both flame retardancy and smoke suppression; they are particularly effective smoke suppressants for synthetic polymers.

In the early 1930s, heteropolymolybdates were found to act as flame retardants for wood [98]. Some 15 years later, ammonium heptamolybdate and sodium molybdate were shown to retard the flammability of cotton fabric, although the treatment was not durable to laundering [99]. Other molybdenum compounds were subsequently used as additives to suppress the flammability and smoke output of plastics [nylon, poly(vinyl chloride), poly(vinylidene chloride), polyesters, and epoxy resins] [100].

The following molybdenum compounds are effective flame retardants and smoke suppressants for both rigid and plasticized poly(vinyl chloride) and halogenated polyester systems [101]:

Molybdenum disulfide,  $\text{MoS}_2$   
 Molybdenum(VI) oxide,  $\text{MoO}_3$   
 Ammonium dimolybdate(VI)(2),  $(\text{NH}_4)_2\text{Mo}_2\text{O}_7$   
 Ammonium heptamolybdate(VI)(6)-4-water,  
 $(\text{NH}_4)_6\text{Mo}_7\text{O}_{24} \cdot 4\text{H}_2\text{O}$

Ammonium octamolybdate(VI)(4),  $(\text{NH}_4)_4\text{Mo}_8\text{O}_{26}$   
 Sodium molybdate(VI),  $\text{Na}_2\text{MoO}_4$   
 Calcium molybdate(VI),  $\text{CaMoO}_4$   
 Zinc molybdate(VI),  $\text{ZnMoO}_4$   
 Copper molybdate(VI),  $\text{CuMoO}_4$   
 Nickel molybdate(VI),  $\text{NiMoO}_4$   
 Iron(III) molybdate(VI),  $\text{Fe}_2(\text{MoO}_4)_3$   
 Flame retardancy in these compounds is linked to the accelerated loss of halogen; their smoke retardancy depends on increased char formation [102].

Molybdenum trioxide and extended proprietary zinc and calcium molybdate compositions are employed as flame retardants in the above-mentioned plastics that are used in the building, transportation, and wire and cable industries.

### 27.7.4 Pigments

Sodium molybdate is the usual starting material for the production of inorganic molybdate chrome pigments and a number of organic pigments (toners) based on cationic or basic dyes. Small amounts of sodium molybdate are also used as a condensation catalyst for phthalocyanine pigments as well as to fix and shade the coloring of furs and hair with azines and the amino- and hydroxy-substituted aromatic compounds used for red brown shades.

**Inorganic Pigments.** Molybdate chrome pigments (molybdenum orange) are generally considered to be modified lead chrome pigments, i.e., compounds of lead chromate and mixed lead chromate and sulfate whose hues range from lemon yellow to primrose. Molybdate chrome pigments exhibit bright red-orange to bright yellow-red hues with the redder hues containing more molybdenum. Molybdate orange pigments are mixed tetragonal crystals whereas the lead chrome pigments form monoclinic and rhombic crystals.

Molybdate chrome pigments are made by coprecipitating lead chromate, molybdate, and sulfate from lead nitrate solutions with sodium chromate, molybdate, and sulfate solutions. The stoichiometry and conditions of precipitation are adjusted to determine the hue. Lead molybdate is itself white, but in the coprecipi-

tated product it distorts the monoclinic lead chromate crystals sufficiently to produce the tetragonal form.

The molybdate chrome pigments exhibit clean colors, good tinctorial and hiding properties; are nonbleeding and soft-grinding; have high heat resistance, and better film gloss and light fastness than lead chrome. They are often used with organic pigments to supply needed hiding power.

Molybdate chrome pigments are more expensive than the lead chromes, but are preferred in many applications for their reddish hue, cleanliness and brightness of color. They are employed in paints, plastics, rubber, and often in printing inks where their opacity, low cost, and heat stability are advantages over organic red pigments.

**Organic Pigments.** Sodium molybdate is also used in the production of organic pigments. Organic pigments have a higher tinctorial strength and brightness than inorganic pigments, but their thermo- and photochemical stabilities are lower and they are more transparent and expensive. Their biggest single use is in the coloring of plastics.

Molybdenum compounds are used in the production of toners derived from cationic or basic dyes that have free or substituted amino groups. The most important dyes are:

Diphenylmethane	Auramine	C.I. 655
Triaryl methane	Malachite Green	C.I. 657
	Brilliant Green	C.I. 662
	Rhoduline Blue 6G	C.I. 658
	Acronol Brilliant Blue	C.I. 664
	Methyl Violet B	C.I. 680
	Victoria Pure Blue BO	C.I. Pr198
Xanthene	Rhodamine B	C.I. 749
	Rhodamine 6G	

The dyes are made into pigments (i.e., insolubilized) by replacing the simple anions (chloride and sulfate) with a heteropolymolybdate acid salt, such as 12-molybdophosphate,  $[\text{PMo}_{12}\text{O}_{40}]^{3-}$ . This acid salt is formed from disodium phosphate and sodium molybdate in the presence of a strong mineral acid (e.g., HCl). The commercial phosphomolybdate pigments or toners are collectively known as PMA colors. The heteropolymolybdate complexes with the basic dye may contain 1 mol

$\text{P}_2\text{O}_5$  with from 12 to 24 mol  $\text{MoO}_3$  as either the free acids or acid sodium salts. Pigments made with combinations of both phosphotungstate (PTA) and phosphomolybdate are known as PTMA colors. The PTMA colors show better fastness than either the PMA or PTA colors, but are also generally costlier.

### 27.7.4.1 Molybdate Red and Molybdate Orange

Molybdate red and molybdate orange, C.I. Pigment Red 104:77605, are mixed-phase pigments with the general formula  $\text{Pb}(\text{Cr}, \text{Mo}, \text{S})\text{O}_4$  [103]. Most commercial products have a  $\text{MoO}_3$  content of 4–6% (refractive index 2.3–2.65, density 5.4–6.3  $\text{g}/\text{cm}^3$ ). Their hue depends on the proportion of molybdate, crystal form, and particle size.

Pure tetragonal lead molybdate, which is colorless, forms orange to red tetragonal mixed-phase pigments with lead sulfochromate. The composition of molybdate red and molybdate orange pigments can be varied to give the required coloristic properties; commercial products usually contain ca. 10% lead molybdate. Lead molybdate pigments have a thermodynamically unstable tetragonal crystal modification that can be transformed into the undesirable stable yellow modification merely by dispersing [104]. This is especially true of the bluish varieties of molybdate red which have larger particles whose color can be changed to yellow by shear forces. The tetragonal modification of the lead molybdate pigments must therefore be stabilized after precipitation [105, 106].

The fastness properties of the molybdate orange and molybdate red pigments are comparable with those of the chrome yellows. As with the chrome yellows, the pigment particles can be coated with metal oxides, metal phosphates, silicates, etc., to give stabilized pigments with high color brilliance and good fastness properties, as well as highly stabilized grades with very good resistance to light, weathering, sulfur dioxide, and temperature, and with a very low content of acid-soluble

lead (DIN 55770, 1986 or DIN/ISO 6713, 1985).

The colors of lead molybdate pigments vary from red with a yellow hue to red with a blue hue. Since chrome orange is no longer available, molybdate orange has become much more important.

**Production.** In the Sherwin-Williams process, a lead nitrate solution is reacted with a solution of sodium dichromate, ammonium molybdate, and sulfuric acid [107]. Instead of ammonium molybdate, the corresponding tungsten salt can be used, giving a pigment based on lead tungstate. The pigment is stabilized by adding sodium silicate (25% SiO<sub>2</sub>) and aluminum sulfate (Al<sub>2</sub>(SO<sub>4</sub>)<sub>3</sub>·18H<sub>2</sub>O) to the suspension, which is then neutralized with sodium hydroxide or sodium carbonate. The pigment is filtered off, washed until free of electrolyte, dried, and ground. Treatment with silicate increases the oil absorption; it also improves light fastness and working properties.

In the Bayer process molybdate red is formed from lead nitrate, potassium chromate, sodium sulfate, and ammonium molybdate [111]. The pigment is then stabilized by adding water glass (28% SiO<sub>2</sub>, 8.3% Na<sub>2</sub>O) to the suspension with stirring, followed by solid antimony trifluoride, stirring for 10 min, and further addition of water glass. The pH is adjusted to 7 with dilute sulfuric acid and the pigment is filtered off, washed free of electrolyte, dried, and ground.

To give the lead molybdate pigments very good stability to light, weathering, chemical attack, and temperature, the same methods are used as those for the stabilization of chrome yellow pigments [108–116].

**Uses.** Molybdate orange and molybdate red are mainly used in paints, coil coatings, and for coloring plastics (e.g., polyethylene, polyesters polystyrene). The temperature-stable grades are the most suitable for coil coatings and plastics.

Molybdate orange and molybdate red have a low binder demand; good dispersibility, hiding power, and tinting strength; and very high light-fastness and weather resistance. Stabili-

zation also gives high-grade pigments with good resistance to sulfur dioxide and high temperature.

Like the chrome yellows, the molybdate reds are used to produce mixed pigments. Combinations with organic red pigments give a considerably extended color range. Such combinations have very good stability properties because of the lightfastness and weather resistance of many organic red pigments are not adversely affected by molybdate pigments.

Total world production of molybdate orange and molybdate red in 1996 was ca. 13 000 t.

#### 27.7.4.2 Molybdate Pigments

Molybdenum-based anticorrosive pigments offer a nontoxic alternative to the zinc chromate pigments [117]. They all have a neutral color (white) but the pure compounds are very expensive. To produce economically competitive pigments molybdate and phosphate pigments are combined, or molybdate compounds are applied to inorganic fillers (e.g., zinc oxide, alkaline-earth carbonates, or talc) [118–121].

Commercially important pigments include basic zinc molybdates (ZnMoO<sub>4</sub>, ZnO), sodium zinc molybdates [Na<sub>2</sub>Zn(MoO<sub>4</sub>)<sub>2</sub>], basic zinc calcium carbonate molybdate, and basic calcium zinc carbonate phosphate molybdate pigments (CaMoO<sub>4</sub>, CaCO<sub>3</sub>, ZnO, Zn<sub>3</sub>(PO<sub>4</sub>)<sub>2</sub>). Properties are given in Table 27.6.

Phosphate-containing molybdate pigments are especially suitable for water-thinnable or latex-based binders, because they improve adhesion to iron substrates. The other molybdate pigments are mainly used in solventborne binder systems.

Unlike chromate ions in chromate pigments, the MoO<sub>4</sub><sup>2-</sup> ions in molybdate pigments are not chemically reduced in most coatings. Hence, they are ineffective for cathodic protection. Their protective action is assumed to be due to activity in the anodic region, similar to that of phosphate ions. As with the protective phosphate films, molybdate films are very resistant to chloride and sulfate [122]. The du-

ration of maximum activity depends on the metal ions used in the pigment and is probably due to differences in solubility.

*Trade names* are as follows:

Molybdenum-based: Moly-White 101, 212, 331 (The Sherwin-Williams Company, USA).

Zinc molybdenum phosphate: Actirox 102, -106 (Colores Hispania, Spain); Moly-White ZNP, -MZA (The Sherwin-Williams Company, USA); Heucophos ZMP (Dr. H. Heubach, Germany).

#### 27.7.5 Agriculture

Molybdenum is an essential trace element for enzymes which fix nitrogen in leguminous crops. Sodium molybdate is used as a soil additive in areas where natural molybdenum is deficient and plant growth suffers. It is usually applied as part of fertilizer or seed treatments.

Table 27.6: Properties of molybdenum-containing pigments.

Property	Zinc molybdate pigment	Cadmium zinc molybdate pigment	Basic sodium zinc molybdate pigment	Basic calcium zinc phosphomolybdate pigment
Density, g/cm <sup>3</sup>	5.06	3.00	4.00	3.00
Oil absorption value, g/100 g	14	18	14	16
Mean particle size, μm (Fisher subsieve sizer)	0.65	1.88	1.02	2.2
pH	6.5	8.5		8

Table 27.7: Atomic absorption spectroscopic analysis for molybdenum.

Absorption line, nm	Sensitivity, ppm/1% abs <sup>a</sup>	Reference
313.26	0.8	[124, 125]
313.26 <sup>b</sup>	0.4	[126]
317.03	1.1	[124]
379.83	1.3	[124]
319.40	1.4	[124]
386.41	1.7	[124]
390.30	2.4	[124]
315.82	2.8	[124]
320.88	5.9	[124]

<sup>a</sup> Defined as the concentration in parts per million (μg/mL) in aqueous solution which produces a 1% absorption signal (0.0044 absorbance) under optimum conditions.

<sup>b</sup> Nitrous oxide-acetylene flame, in all other cases air-acetylene flames, were used.

About 0.25 kg molybdenum per acre (0.62 kg/ha) may be used.

#### 27.8 Analysis

Molybdenum can be determined by gravimetric, volumetric, and colorimetric methods [123]. As long as great accuracy is not required, the most satisfactory method is, however, atomic absorption spectroscopy.

**Atomic Absorption Spectroscopy.** The absorption lines used and the achievable sensitivities in atomic absorption spectroscopy are shown in Table 27.7. Sensitivity may be increased by using a three-slot burner or by inert gas separation of the flame. Interference due to the presence of calcium, strontium, manganese, iron, and sulfate is reported to be eliminated in the presence of large amounts of aluminum [127] or 2% ammonium chloride [124].

In the first report of the use of atomic absorption for molybdenum analysis [127], stainless steel samples were employed with an air-acetylene flame and ammonium chloride as a releasing agent. If the composition in the molybdenum standard solutions is matched with that of the sample solution by addition of appropriate quantities of the other metal salts present in the samples [128], a releasing agent is not necessary. An alternative is to separate the molybdenum from other metals in the sample solution by liquid-liquid (or solvent) extraction. This technique can also be used to concentrate the molybdenum solution before analyzing it. For example, quantities as low as 10<sup>-4</sup>% have been determined in silicate rocks by extracting molybdenum from the aqueous sample with 8-hydroxyquinoline [129]; tolu-

ene-3,4-dithiol and ammonium pyrrolidine dithiocarbamate can also be used as extraction agents. Rock samples can be fused with sodium hydroxide and baked at ca. 650 °C for 30 min.; after cooling the residue is treated with sulfuric acid and filtered. Alternatively, the sample can be treated directly with acid and filtered. Molybdenum in the filtrate has been extracted with  $\alpha$ -benzoinoxime into chloroform [130].

**Volumetric Methods.** In the volumetric procedure, molybdenum in solution is reduced by zinc in a Jones reductor, the emerging solution is led under the surface of a ferric sulfate solution and titrated with potassium permanganate [123].

**Gravimetric Methods.** The older of the two main gravimetric methods is the precipitation of lead molybdate by slow addition of a lead acetate solution to a hot dilute acetic acid–ammonium acetate buffer solution containing the molybdenum. Free mineral acids prevent complete precipitation of the molybdenum. Cobalt, copper, magnesium, manganese, mercury, nickel and zinc do not interfere. Sulfate must be absent if alkaline-earth metals are present. If chloride is present, addition of a large excess of the lead acetate solution must be avoided. Since many metals interfere with the determination (antimony, arsenic, chromium, iron, phosphorus, silicon, tin, titanium, tungsten, and vanadium), it is not suitable for the determination of molybdenum in steels.

The other important gravimetric method is fairly satisfactory for steels and involves precipitation of molybdenum with  $\alpha$ -benzoinoxime and ignition of the precipitated complex to molybdenum trioxide, which is weighed.

The sample is dissolved in dilute (1:6) sulfuric acid and the solution is treated with a minimum amount (ca. 2 mL) of concentrated nitric acid to decompose carbides and oxidize the iron and molybdenum. The solution is boiled to expel nitrogen oxides and filtered if necessary. To the cool solution sufficient iron(II) ammonium sulfate solution is added to reduce vanadium(V) and chromium(VI) acids.

An excess of a 2% solution of  $\alpha$ -benzoinoxime in ethanol is added at 5 °C, followed by bromine water until the solution is pale yellow, and then more  $\alpha$ -benzoinoxime. The precipitate on the filter paper is washed with a freshly prepared solution containing 10 mL of the 2% reagent solution and 2 mL of concentrated sulfuric acid diluted to 200 mL. After charring, ignition at 500–525 °C, and weighing, the residue is treated with 5 mL of concentrated ammonia to remove the molybdenum and tungsten trioxides and the residual solid is ignited and weighed. If tungsten is present the ammoniacal extract is acidified with sulfuric acid and evaporated to dense white fumes. After diluting, the tungsten is precipitated using cinchonine and weighed as the trioxide after ignition at 750–850 °C.

Another gravimetric method often described involves precipitation of molybdenum as sulfide and ignition to oxide. This is not satisfactory because loss due to volatilization is likely to occur. The complex of molybdenum with 8-hydroxyquinoline,  $\text{MoO}_2(\text{C}_9\text{H}_6\text{ON})_2$ , is precipitated within the pH range 3.3–7.6. It differs from complexes of the reagent with other metals in being insoluble in organic solvents and in many concentrated inorganic acids. The freshly precipitated compound dissolves only in concentrated sulfuric acid and in hot solutions of alkali-metal hydroxides. This determination allows complete separation of molybdenum and rhenium.

**Colorimetric Methods.** Molybdenum(VI) in acidic solution can be reduced to give mainly molybdenum(V), which forms a red complex with thiocyanate. This complex can be extracted from water with organic solvents, particularly oxygenated compounds, providing a very sensitive spectrophotometric method. Tin(II) chloride is a suitable reducing agent, preferably used in the presence of a little iron(II). The method can be used to determine molybdenum in steels.

The steel sample is dissolved in mixed hydrochloric perchloric acids, heated until dense white fumes are evolved and finally heated for a further 6–7 min. After cooling the solution is

diluted with water and made up to a known volume. An aliquot is reduced with tin(II) chloride in the presence of iron(II) and potassium thiocyanate is added. The color depends on the acid concentration (optimum value 1 mol/L) and the thiocyanate concentration (should not be less than 1%). The red complex is extracted into 3-methyl-1-butanol and the optical density measured at 465 nm. When the quantity of Mo in a 1-cm cell is 10  $\mu\text{g}$  the following elements cause an error greater than 3% when present in the amount specified: vanadium > 0.4 mg (interference is prevented by washing the organic extract with tin(II) chloride solution); chromium(VI) > 2 mg; tungsten(VI) > 0.15 mg; cobalt > 12 mg; copper > 5 mg; lead > 10 mg; titanium(III) in the presence of fluoride > 30 mg. The method is also recommended for the determination of molybdenum present as a trace element in fertilizers and animal feeds, the complex being extracted from the aqueous solution using a 1:1 mixture of carbon tetrachloride and 3-methyl-1-butanol [131]. The sample solution is prepared by dry ashing the feed at  $\leq 450$  °C, treating the ash with hydrochloric acid, and evaporating to dryness. The residue is successively extracted with hot hydrochloric acid, the penultimate treatment being to take to dryness with a little nitric acid. The combined extracts are diluted to give an approximately 1 mol/L solution of acid. Inorganic fertilizers are extracted directly with hydrochloric acid. After evaporation to dryness the residue is treated in the same way as the ash from feeds.

## 27.9 Economic Aspects

Three factors form the basic economic character of the molybdenum industry:

- Molybdenum consumption
- Molybdenum supply
- Excess production capacity

The iron and steel industry accounts for ca. 80% of all *molybdenum consumption* in the Western world. The balance of consumption is split between nonferrous metallurgical uses and chemical applications. Estimated con-

sumption of molybdenum in the Western world in 1989 according to end use is as follows (exports to Eastern-Bloc countries are not included):

Alloy steel	35%
Stainless steel	27%
Mo-base and superalloys	12%
Chemicals	11%
Tool steel	9%
Cast irons	6%

The metallurgical uses of molybdenum are primarily for the fabrication of plant and equipment; its consumption follows the capital goods cycle. The chemical uses for molybdenum involve chiefly catalyst, lubricant, aqueous corrosion inhibition, and color applications whose demand adheres to general industrial activity.

Sources of *molybdenum supply* in the Western world in 1989 were estimated to be as follows:

Primary mines	41%
By- and coproducts of copper mining	54%
Imports from China	3%
Recovery from spent petroleum catalysts	2%

In general, the cash cost of nonprimary production is significantly lower than the cost of primary mine production. This cost advantage enables nonprimary producers to sell at lower prices than their primary counterparts. Primary production is the first supply segment to react to changes in market conditions.

The molybdenum industry has significant *excess capacity*. Encouraged by unrealistic demand expectations, nearly 50 000 t of primary mine capacity was installed during the late 1970s and early 1980s. This, in combination with the continued growth of by-product production and the emergence of China as a supplier, has resulted in a Western world supply capacity of over 125 000 t. Western world demand in 1989, including exports to the Eastern-Bloc countries, though at record levels, was only 95 700 t.

Tables 27.8 and 27.9 contain estimates for molybdenum supply and demand which show that production exceeded demand during most of the past decade. Tables 27.10 and 27.11 list the major molybdenum mines and conversion operations (molybdenum roasting and ferromolybdenum conversion).

**Table 27.8:** Estimated Western world molybdenum demand (10<sup>3</sup> t contained Mo).

	1980	1981	1982	1983	1984	1985	1986	1987	1988	1989
United States	27.2	26.3	15.4	14.1	17.7	16.8	17.2	18.6	23.1	24.5
Western Europe	29.5	26.8	25.0	24.0	29.5	29.5	29.5	30.4	37.2	37.2
Japan	12.7	12.7	11.8	10.9	11.8	12.2	11.8	11.8	15.4	15.0
Other Western Countries	5.9	6.4	5.9	6.4	6.8	7.3	7.7	7.7	8.2	8.2
Exports to Eastern Bloc	11.3	11.3	11.3	10.4	11.3	11.8	10.5	10.4	10.0	10.8
Total demand	86.6	83.5	69.4	65.8	77.1	77.6	76.7	78.9	93.9	95.7

**Table 27.9:** Estimated Western world molybdenum production (10<sup>3</sup> t) (includes both mine production and recovery from spent petroleum catalyst).

	1980	1981	1982	1983	1984	1985	1986	1987	1988	1989
United States	68.3	63.3	38.5	15.2	46.3	49.6	42.5	35.0	43.8	64.0
Chile	13.7	15.4	20.0	15.3	16.9	18.4	16.6	16.9	15.5	17.0
Canada	15.4	17.5	14.4	9.3	8.9	7.4	11.9	12.4	12.5	14.4
Other <sup>a</sup>	3.4	3.9	8.2	8.4	9.3	9.8	12.5	13.4	11.4	11.5
Total production	100.8	100.1	81.1	48.2	81.4	85.2	83.5	77.7	83.2	106.9
Metal loss	1.5	1.5	1.2	0.7	1.2	1.3	1.3	1.2	1.0	1.5
Net production	99.3	98.6	79.9	47.5	80.2	83.9	82.2	76.5	82.2	105.4

<sup>a</sup> Includes Western world imports from China.

**Table 27.10:** Major molybdenum sites (Source: Climax Metals Company).

Parent company	Mine <sup>a</sup>	Location
AMAX-Climax	Henderson (P)	Colorado, USA
AMAX-Climax	Climax (P)	Colorado, USA
Cyprus	Thompson Creek (P)	Idaho, USA
Cyprus	Tonopah (P)	Nevada, USA
UNOCAL-Molycorp	Questa (P)	New Mexico, USA
Placer	Endako (P)	B.C., Canada
BHP	Island Copper	B.C., Canada
Codelco	Andina	Chile
Codelco	Chuquicamata	Chile
Codelco	El Salvador	Chile
Codelco	El Teniente	Chile
Cyprus	Bagdad	Arizona, USA
Cyprus	Sierrita	Arizona, USA
Highland Valley Copper	Highland Valley	B.C., Canada
Magma Copper	San Manuel/Pinto Valley	Arizona, USA
Mexicana de Cobre	La Caridad	Mexico
Montana Resources	Butte	Montana, USA
National Iranian Copper	Sar Cheshmeh	Iran
Noranda <sup>b</sup>	Brenda	B.C., Canada
Phelps Dodge	Chino/Morenci	Arizona, USA
RTZ-Kennecott	Bingham Canyon	Arizona, USA
Southern Peru Copper	Cuajone	Peru
Southern Peru Copper	Toquepala	Peru

<sup>a</sup> P = primary mine.

<sup>b</sup> Closed June 1990 with depletion of mining reserves.

**Table 27.11:** Major molybdenum converters (Source: Climax Metals Company).

Parent company	Location
AMAX-Climax	USA, UK, Netherlands
Anglo Blackwells	UK
Codelco	Chile
Cyprus	USA
Eldorado Gold Mines	Canada
Empresas Frisco	Mexico
Ferro Alloys	UK
H. C. Starck	Germany
Japan Metals & Chemicals	Japan
Molycorp	USA
Molymet	Chile
M. P. Trollhattan	Sweden
Murex	UK
Nippon Denko	Japan
Pechiney	France
Placer	Canada
RTZ-Kennecott	USA
Sadacem	Belgium
Showa Denko	Japan
Treibacher C. W.	Austria

## 27.10 Environmental Aspects

The regulation of chemical discharges into the environment is increasing dramatically and will continue to do so in the 1990s. Existing restrictions on molybdenum discharges

will likely be enforced at the state or local level in the United States and at the national level in Europe.

General aspects of molybdenum in the environment are reviewed in [132]. Additional studies and reviews further explore the impact of molybdenum in the environment [133, 134]. Although molybdenum can cause problems in the environment when discharged in excessive quantities, the problems are well defined and are easily corrected in most instances.

**Wastewater.** Soluble molybdenum compounds exhibit medium to low levels of toxicity when discharged into either fresh water, salt water, or sewage treatment facilities. Table 27.12 summarizes relevant ecotoxicity data.

In the United States, effluent guidelines for molybdenum have been established for some industrial categories. These guidelines are technology-based and not toxicity-related. Calculation of individual discharge limitations is based on process production rates. The EPA has not established generic molybdenum lim-

its for industrial discharges nor has it established stream or drinking water standards for molybdenum.

**Exhaust Gas.** Molybdenum compounds are not specifically regulated as a component of process exhaust gases. Control of molybdenum compounds in exhaust gases is accomplished by use of standard equipment such as bag houses, cyclones, and scrubbers. Efficiency of removal is typically monitored by noting total suspended particulate discharge rates. Work place exposure for insoluble molybdenum compounds in the United States is currently controlled at 10 mg/m<sup>3</sup> [144] which is the same as the TLV-TWA for nuisance dusts. Soluble molybdenum compounds in the work place are controlled at 5 mg/m<sup>3</sup> [144]. Exposure limits in other countries may differ slightly from the U.S. values and should be consulted accordingly. Under the United States Emergency Planning and Community Right-To-Know Act, molybdenum trioxide is considered a toxic chemical and is subject to annual chemical release reporting [145].

**Table 27.12:** Ecotoxicity of molybdenum compounds.

Species or medium	Molybdenum compound	Toxicity	Reference
Freshwater fish	sodium molybdate dihydrate	LC <sub>50</sub> (96 h) fathead minnow, 7630 mg/L	[135]
	ammonium dimolybdate	LC <sub>50</sub> (96 h) bluegill, 6790 mg/L	[136]
	molybdenum trioxide (pure)	LC <sub>50</sub> (96 h) rainbow trout, 7340 mg/L	[136]
		LC <sub>50</sub> (96 h) channel catfish, > 10 000 mg/L	
		LC <sub>50</sub> (48 h) bluegill, 157 mg/L	
Daphnia	sodium molybdate dihydrate	LC <sub>50</sub> (48 h) rainbow trout, 135 mg/L	
		LC <sub>50</sub> (48 h) bluegill, 65 < LC <sub>50</sub> < 87 mg/L	
		LC <sub>50</sub> (96 h), 3940 mg/L	[135]
Saltwater species	sodium molybdate dihydrate ammonium molybdate	LC <sub>50</sub> (96 h) mysids shrimp, 3997 mg/L	[137]
		LC <sub>50</sub> (96 h) sheepshead minnow, 6590 mg/L	[138]
		LC <sub>50</sub> (96 h) pink shrimp, 3997 mg/L	
		EC <sub>50</sub> American oyster, 3526 mg/L LC <sub>50</sub> (48 h) marine shore crab, 1018 mg/L as Mo	
Activated sludge	sodium molybdate dihydrate	no effect level > 2522 mg/L (slug dose)	[139]
Anaerobic sludge	sodium molybdate dihydrate	no effect level > 2522 mg/L (slug dose)	[139]
Mammals	molybdenum trioxide (pure) molybdenum trioxide (technical) sodium molybdate molybdenum disulfide	LD <sub>50</sub> oral-SD rat 2.73 g/kg	[140]
		LD <sub>50</sub> oral-SD rat 6.66 g/kg	[141]
		LD <sub>50</sub> ipr-mus 344 mg/kg	[142]
		no effect level, oral-SD rat > 15 g/kg	[143]



**Solid Waste.** Within the European Economic Community (EEC) and some other European countries (e.g., Switzerland), the molybdenum content of sewage sludge used for agricultural purposes is subject to regulation. In the United States, the EPA is developing guidelines for use of sewage sludge in agriculture, and will set acceptable limits for metals. Industrial waste in the United States and the EEC is not specifically regulated as to molybdenum content.

The Netherlands has adopted soil and groundwater contamination guidelines for molybdenum [146]. The pollutants regulated are classified in the "Black" and "Grey" lists, and are derived from a 1976 EEC Directive [147]. Chemicals on the Black list are considered very toxic and are persistent and/or bioaccumulate. Chemicals on the Grey list, which includes molybdenum, are of general concern in the environment.

The most widely studied environmental problem with molybdenum is its impact on ruminants that graze on forage with a high molybdenum content [148]. Environmental protection must therefore first identify the probable land use and then develop the control strategy necessary to mitigate the impact. For example, treatment of soil with sewage sludge has to be controlled so that the soil molybdenum content does not exceed 10 mg/kg [149]. Liming of soil lowers the accumulation of molybdenum in the surface plow layer because of the increased solubility at alkaline pH [149]. Due to the biological antagonism of copper toward molybdenum, dietary supplementation of ruminants with copper mitigates the effects of molybdenosis [149]. Sewage sludge with a high molybdenum content usually has a high copper content too which reduces the probability of molybdenosis in ruminants foraging on sludge-treated pasture. Sludge with less than 50 mg/kg molybdenum on a dry weight basis should therefore be acceptable for long-term land application at an annual addition rate of 10 000 kg/ha.

## 27.11 Toxicology and Occupational Health

"Molybdenum compounds in general are of a low order of toxicity, both from the point of view of observed clinical effects as well as from the histopathologic point of view" [150]. Toxicity is primarily associated with soluble molybdenum compounds. For example, both inhalation and ingestion of insoluble molybdenum disulfide and calcium molybdate failed to produce significant histopathological findings in either rat or guinea pigs [150].

**Human Nutrition.** Molybdenum is an essential trace element. Leguminous plants require molybdenum for bacterial fixation of nitrogen. In animals and humans it serves as a cofactor for the enzymes xanthine oxidase (which oxidizes xanthine to uric acid [151]) and aldehyde oxidase. Probably 25–75% of molybdenum in the diet is absorbed through the gastrointestinal tract and is rapidly eliminated, primarily via the urine. The biological half-life is not well established for humans, but most of the absorbed molybdenum is eliminated within a few days or weeks. Animal data indicate that the metabolism of molybdenum is closely related to the metabolism of copper and sulfur compounds [152].

The normal daily human dietary intake of molybdenum in the United States is estimated to be 100–500  $\mu\text{g}$ . High molybdenum concentrations are generally found in leafy vegetables (up to 5  $\mu\text{g}/\text{g}$  wet weight); legumes with edible roots have a low molybdenum content (< 1  $\mu\text{g}/\text{g}$  wet weight). There are no human or animal studies implying accumulation of molybdenum in the body during the life cycle [153].

The relationship of molybdenum deficiency and esophageal cancer in humans was first reported in 1966 [154]. The high incidence of this cancer was attributed to the consumption of food locally grown in soil low in molybdenum. As reported in 1981, a study in China demonstrated an inverse relationship between the mortality rate of esophageal cancer and the content of Mo, Zn, Mn, Si, Ni, Fe,

Bi, and I in cereal and drinking water samples [155]. Levels of molybdenum in the serum, hair, and urine of the inhabitants of the high-risk area were lower than those in the low-risk areas. Utilizing animal models, this inhibitory effect of molybdenum on esophageal, fore stomach, and mammary carcinogenesis has been demonstrated in laboratory studies [156, 157, 158].

**Human Toxicity.** Information on the toxic effects of molybdenum in humans is scarce. A 1961 study reported a high incidence of gout in an area of Armenia in which the soil contained 77 mg/kg of molybdenum and 39 mg/kg of copper [153]. Daily dietary intake of molybdenum was calculated to be 10–15 mg and that of copper 5–10 mg; corresponding values in the control area were 1–2 mg Mo and 10–15 mg Cu. The study showed an increased prevalence of goutlike joint disorders, elevated blood levels of uric acid, and an increase in the urinary excretion of uric acid [153]. The results are difficult to evaluate since no details are given concerning the study population and the selection of subjects. Furthermore the control group consisted of only five subjects.

A study in another high-molybdenum province in the former Soviet Union failed to detect biological changes in the study population. A tentative explanation is that a higher intake of natural copper may have protected the population against the molybdenum exposure [153]. Animal studies have demonstrated a biological antagonism of copper toward molybdenum.

A study of four humans in India, detected a significant increase in copper metabolism with dietary intakes of molybdenum ranging from 160 to 2540  $\mu\text{g}/\text{d}$ . However, the study failed to detect any effect on the urinary excretion of uric acid [159].

On the basis of the above studies, MERTZ suggests that a dietary intake of more than 10 mg/d of molybdenum is dangerous to human health, but that intakes of up to 1.5 mg/d do not appear to have an effect except for an increase in urinary copper excretion [160]. With a daily molybdenum intake of 540  $\mu\text{g}$ , copper

excretion was elevated but was still within normal range. In adult humans with a normal copper intake (1.5–2.5 mg/d), MERTZ proposes that a dietary molybdenum intake of 0.5–1.0 mg/d can be assumed to be safe. Based on balance studies conducted in areas where the diet is generally adequate in molybdenum and no molybdenum disease has been observed in humans, the U.S. National Academy of Sciences has estimated an adequate and safe intake of molybdenum for humans as being 0.15–0.5 mg/d [161].

**Animal Toxicity.** Most observations on the toxicity of molybdenum are based on animal data. Excessive exposure to molybdenum via food can cause severe disease in ruminants which involves diarrhea, anemia, and emaciation, and may progress to death. The disease was first identified in 1938 as the cause of a long-recognized problem in cattle grazing in areas called "teart" pastures in Somerset, England. By 1943 large doses of copper sulfate were shown to prevent or cure "teart" disease. The clinical signs of molybdenum toxicity in animals are primarily due to copper deficiency. After long exposure, the hair loses its color and lameness with a characteristic stiff gait may develop. The latter symptoms may be associated with disturbance of phosphorous metabolism resulting in osteoporosis and joint abnormalities [162].

Young lambs grazing on high-molybdenum pastures suffer from a bone or joint disorder known as swayback. Sheep also develop steely wool, but not the severe diarrhea seen in cattle [163]. Copper deficiency in lambs also lowers their resistance to infections, such as pneumonia [164].

Evidence indicates that cattle are the most susceptible to molybdenum toxicity of any species, followed by sheep. Horses grazed the "teart" pastures of Somerset without showing any clinical signs of toxicity. Rabbits [165], guinea pigs, rats, pigs, and chickens [164] are comparatively tolerant to molybdenum.

Due to the great variability in results, the data available for cattle and sheep provide little assurance about safe levels of molybde-

num; a level of 5–10 ppm in pasture forage is usually considered a conservatively safe molybdenum level. The clinical symptoms of molybdenum toxicity or molybdenosis are primarily due to a conditioned or secondary copper deficiency. The most reliable indication of molybdenosis or copper deficiency is alteration of the symptoms by copper supplementation. In some areas where animal forage is deficient in copper, pastures with molybdenum levels normally considered to be in the safe range could trigger signs of molybdenosis. At the other extreme, forage that is naturally high in copper produces copper toxicity and supplemental dietary molybdenum may be necessary.

The results of acute toxicity tests ( $LD_{50}$  and  $LC_{50}$  values) are given in Table 27.12. In literature citing acute testing, low  $LD_{50}$  values (i.e., high toxicity) are sometimes given for molybdenum compounds. Some of these low levels are the result of long-term feeding studies but are interpreted as single-dose acute studies. For example, the acute oral  $LD_{50}$  in rats for molybdenum trioxide is frequently listed in the literature as 125 mg/kg, indicating that it is highly toxic. This  $LD_{50}$  was, however, determined by a 44-day feeding study [150], not by a single dose. The acute oral  $LD_{50}$  of molybdenum trioxide, pure grade, when determined by a single dose in rats, ranges from 2960 mg/kg to 3520 mg/kg [166].

**Occupational Health.** Several studies on the industrial exposure of humans to molybdenum have been reported from the former Soviet Union. A 1963 study reported 3 cases of pneumoconiosis out of 19 workers exposed to metallic molybdenum and its oxide. Early signs of pneumoconiosis were identified by X-ray in a 44-year old woman exposed for 5 years to molybdenum concentrations ranging from 1–3 mg/m<sup>3</sup> and in a 44-year old man exposed for 4 years to concentrations between 6 and 19 mg/m<sup>3</sup>. A 34-year old man exposed for 7 years to concentrations between 6 and 19 mg/m<sup>3</sup> showed fully developed pneumoconiosis [167].

In another Russian study 73 workers in a copper molybdenum plant complex and 10 control subjects were studied [168]. Workers with the highest exposure had the highest blood level of uric acid, and increased blood uric acid was found in 34 out of the 37 workers who complained of arthralgia. The actual values of uric acid in blood were not reported in this study, nor was the exposure defined.

Hyperuricemia was also described in another study on 85 workers in a copper molybdenum plant in Kadzaran, former Soviet Union [169]. An increase in blood concentrations of bilirubin, globulins, and cholesterol was observed but no values or exposure data were provided. In a study on 500 workers from a Russian molybdenum and copper mine, nonspecific symptoms and changes in the central nervous system were reported. Molybdenum dust levels in the mines were in some cases 10–100 times higher than the Soviet maximum permissible level of 6 mg Mo/m<sup>3</sup> [170].

The effects of molybdenum exposure was studied in 25 male workers [mean age 28.3 years (19–44 years), mean duration of employment 4.0 years (0.5–20 years)] from a roasting plant in Denver, Colorado, where molybdenum sulfide was converted to molybdenum oxides [171]. Total dust samples were collected in the roaster area and the 8-h time weighted average (TWA) molybdenum exposure was calculated to be 9.47 mg/m<sup>3</sup>. The respirable (< 10 μm) molybdenum concentration in the dust at the base of the roaster was 1.02 mg/m<sup>3</sup> and the minimum daily body burden of molybdenum was calculated to be 10.2 mg. Urinary and plasma molybdenum levels were higher for the worker group than for the control group. Except for some generalized medical complaints, the only adverse biochemical findings were elevated serum ceruloplasmin levels and a small increase in serum uric acid the mean value of which was within the normal range of the control group. No gout-like symptoms were reported. Urinary copper excretion was normal in 13 of the 14 workers.

In the United States, health and safety regulations have established permissible exposure limits (PELs) in the occupational environment at 5 mg/m<sup>3</sup> for soluble molybdenum compounds. The Threshold Limit Values (TLVs) have also been established by the ACGIH for soluble and insoluble molybdenum at 5 and 10 mg/m<sup>3</sup>, respectively. Both the PELs and TLVs are time-weighted averages (TWAs) for 8 h/d. Although the study of the 25 workers [171] may be considered limited because of the small population and high employment turnover, the absence of any adverse health effects at an exposure level approximately twice the soluble molybdenum PEL is of considerable value in assessing the potential worker risk to molybdenum exposure.

## 27.12 References

1. A. Sutulov: *Molybdenum Extractive Metallurgy*, University of Concepción, Chile 1965.
2. A. Sutulov: *International Molybdenum Encyclopedia 1778–1978*, vol II, Internet Publications, Santiago, Chile 1979.
3. J. W. Blossom: *Minerals Yearbook*, vol I, Metals and Minerals, U.S. Bureau of Mines, U.S. Government Printing Office, Washington, D.C. 1987, pp. 633–640.
4. J. W. Blossom: *Mineral Facts and Problems*, U.S. Bureau of Mines, Bulletin 675, U.S. Government Printing Office, Washington, D.C. 1985, pp. 521–534.
5. L. Northcott: *Molybdenum*, Butterworths Scientific Publications, London 1956.
6. S. M. Johnson in: *Mining Annual Review 1989*, Mining Journal, London 1989, p C72.
7. Bureau of Mines: *An Appraisal of Minerals Availability for 34 Commodities*, Bulletin 692, U.S. Department of the Interior, Washington, D.C. 1987, p. 191.
8. J. Banfield (ed.): *Financial Times International Year Book 1989*, Longman Group UK Ltd., Harlow, Essex, United Kingdom; St. James Press, Chicago, Illinois 1988.
9. R. R. Dorfler, J. M. Laferty: "Review of Molybdenum Recovery Processes", *J. Met.* 31 (1981) no. 7, 48–54.
10. "50 Years of Flotation... It's Men, Ideas, and Machines", *Eng. Min. J.* 162 (1961) 83–91, 116, 120, 123, 125, 127.
11. V. A. Glemholksii: *Flotation*, Primary Sources, New York 1963.
12. C. A. Born, F. N. Bender, O. A. Kiehn: "Molybdenite Flotation Reagent Development at Climax, Colorado", in D. W. Fürstenau (ed.) *A. M. Gaudin Memorial Vol. II*, AIME, New York 1976, pp 1147–1184.
13. R. E. Cuthbertson: "Unusual Reagent Combination Improves Flotation at Climax", *Min. Elec. Mech. Eng.* 24 (1944) no 292 1675–1680.
14. K. P. Neumann, W. A. Gibson: "Amoco Develops Thompson Creek Molybdenum Mine", *Min. Eng. Littleton. Color.* 36 (1984) 27–30.
15. D. Malhotra, R. M. Rowe, A. K. Bhasin: "Evaluation of Collectors for Molybdenite Flotation", *Minerals and Metallurgical Processing*, V3, m3, Aug. 1986, pp. 184–186.
16. J. F. Shirley: "By-product Molybdenite Plant Design", *Can. Min. J.* 102 (1981) no. 3, 27–28.
17. R. D. Crozier: "Flotation Reagent Practice in Primary and By-product Molybdenum Recovery", *Min. Mag.* 7 (1979) 174–178.
18. L. F. McHugh, J. Godshalk, M. Kuzlor: "Climax Conversion Practice III (for Molybdenite)", *Conference of the Metallurgical Society of CIM, 1977*, Canadian Institute of Mining and Metallurgy, Montréal 1978.
19. D. G. Lindsay: "Endako Roasting Practice", *Conference of the Metallurgical Society of CIM, 1977*, Canadian Institute of Mining and Metallurgy, Montréal 1978.
20. Amax, Inc., US 4207296, 1980 (H. H. K. Nauta, J. W. Kok, J. Harte).
21. Herman C. Starck, US 3860419, 1975 (T. A. Weber, R. F. Borrmann).
22. L. F. McHugh, P. L. Sallade: "Molybdenum Conversion Practice", Paper no. 86–154, presented at SME Annual Meeting, New Orleans, LA, March 2–6, 1986.
23. Engelhard Min. & Chem. Corp., US 4296077, 1981 (S. R. Heuer, Z. Zbransk).
24. Akzona, Inc., US 4087510, 1978 (G. F. Steenken).
25. Union Carbide Corp., US 3773890, 1973 (J. S. Fox, J. E. Litz).
26. Amax, Inc., US 4495157, 1985 (R. F. Sebenik, P. P. LaVale, J. M. Laferty, W. A. May).
27. Marubeni Corp. and Fuji Fine Chemical Co., US 4145397, 1979 (S. Toida, A. Ohno, K. Higuchi).
28. Individual, US 3256058, 1966 (B. Burwell, Sr.).
29. *Gmelin*, System no. 53, Molybdän; suppl., part A1.
30. G. Dowson, *Met. Powder Rep.* 44 (1989) no. 4, 272–275.
31. W. C. Hagel, J. A. Shields, S. M. Tuominen, CONF-8308130, US Department of Energy, Oak Ridge, USA 1984.
32. A. J. Bryhan, *Weld. Res. Council. Bull.* 312 (1986) 1–20.
33. C. A. Krier, DMIC, Battelle Information Center, Rep. 263 (1961) Columbus, Ohio.
34. R. Eck, J. Tinzl, *12th International Plansee Seminar, Proc.* 1 (1989) 829–843.
35. J. Wadsworth, T. G. Nieh, J. J. Stephens, *Int. Mat. Rev.* 33 (1988) no 3, 131–150.
36. T. J. Patrician, V. P. Sylvester: "Physical Metallurgy and Technology of Molybdenum and its Alloys", *Proc. of Symp. AMAX Material Research Center, Ann Arbor, Michigan 1985*, pp. 1–11.
37. *Gmelin*, Molybdenum Suppl., vols. B1, B2.
38. F. A. Cotton, G. Wilkinson: *Advanced Inorganic Chemistry*, 5th ed., Wiley, New York 1988, pp 804–847.

39. J. Aubry, D. Burnel, C. Gleitzer in P. Pascal (ed.) *Compléments au Nouveau Traité de chimie minérale*, vol. 5, Masson, Paris 1976.
40. C. L. Rollinson in A. F. Trotman-Dickenson (ed.): *Comprehensive Inorganic Chemistry*, vol. 3, Pergamon Press, Oxford 1973, pp 632-770.
41. G. Brauer (ed.): *Handbook of Preparative Inorganic Chemistry*, 2nd ed., vol. 2, Academic Press, New York 1965, pp 1401-1417.
42. Chem. Uses Molybdenum, *Proc. Int Conf. 1st*, 1973 (*J. Less-Common Met.* 36 (1974) 1-542); *2nd*, 1976 (*J. Less-Common Met.* 54 (1977) 1-564); *3rd*, 1979; *4th*, 1982; *5th*, 1985 (*Polyhedron* 5 (1986) 1-606).
43. P. C. H. Mitchell, *Q. Rev. Chem. Soc.* 20 (1966) 103-118; E. I. Stiefel, *Prog. Inorg. Chem.* 22 (1977) 1; Z. Dori, *Prog. Inorg. Chem.* 28 (1981) 239.
44. F. A. Cotton, *Polyhedron* 5 (1986) 3.
45. A. Muller, *Polyhedron* 5 (1986) 323.
46. A. J. Bard, R. Parson, J. Jordan: *Standard Potentials in Aqueous Solutions*, Marcel Dekker, New York 1985, p. 480; J. Emsley: *The Elements*, Clarendon Press, Oxford 1989, p. 116.
47. A. Kay, P. C. H. Mitchell, *Nature (London)* 219 (1968) 267; *J. Chem. Soc. A* 1970, 2421.
48. J. Bassett, R. C. Denney, G. H. Jeffery, J. Mendham: *Vogel's Textbook of Quantitative Inorganic Analysis*, 4th ed., Longman, London 1978, p. 367.
49. T. L. Woods, R. M. Garrels: *Thermodynamic Values at Low Temperatures for Natural Inorganic Materials* (mean values), Oxford University Press, Oxford 1987.
50. Climax Molybdenum Company: *Thermodynamic Properties of Molybdenum Compounds*, Bulletin Cdb-2, Climax Molybdenum Company, Ann Arbor, Michigan 1954 (some values have been superseded, see [49, 60]).
51. See [41] p. 1412.
52. J. E. Germain in M. Che and G. C. Bond (eds.): *Adsorption and Catalysis on Oxide Surfaces*, Elsevier, Amsterdam 1985, p. 355; K. Bruckman, J. Haber, T. Wiltowski, *J. Catal.* 106 (1987) 188; J. Haber, E. Serwicka, *Polyhedron* 5 (1986) 107; K. Bruckman et al., *J. Catal.* 104 (1987) 71.
53. C. B. Knobler et al., *J. Chem. Soc. Dalton Trans.* 1983, 1299.
54. F. A. Schroder, J. Scherle, *Z. Naturforsch. B: Anorg. Chem. Org. Chem.* 28B (1973) 46; see also C. B. Knobler, B. R. Penfold, G. T. Wilkins, *J. Chem. Soc. Dalton Trans.* 1980, 248.
55. A. Magneli, *Acta Chem. Scand.* 9 (1955) 1378.
56. B. G. Brandt, A. C. Skapski, *Acta Chem. Scand.* 21 (1967) 661; *Acta Crystallogr. Sect. A Cryst. Phys. Diffr. Theor. Gen. Crystallogr.* A24 (1968) 699.
57. V. K. Rudenko, *Koord. Khim.* 5 (1979) 307; (*Sov. J. Coord. Chem.* — Engl. Transl.) 5 (1979) 231.
58. See ref. [48] p. 756.
59. M. Greenblat, *Chem. Rev.* 88 (1988) 31.
60. K. C. Mills: *Thermodynamic Data for Inorganic Sulfides, Selenides, and Tellurides*, Butterworths, London 1974.
61. K. S. Liang et al., *J. Non-Cryst. Solids* 42 (1980) 345.
62. R. Chevrel, M. Hirrien, M. Sergent, *Polyhedron* 5 (1986) 87.
63. Climax Molybdenum Company: *Properties of the Simple Molybdates*, Bulletin Cdb-4, Climax Molybdenum Company, Ann Arbor, Michigan 1962.
64. F. Corbet, C. Eyraud, *Bull. Soc. Chim. Fr.* 1961, 571; J. Chojnacki, R. Kozlowski, J. Haber, *J. Solid State Chem.* 11 (1974) 106; J. Haber in P. C. H. Mitchell (ed.) *Climax First International Conference on the Chemistry and Uses of Molybdenum*, Climax Molybdenum Co. Ltd., London 1973, p. 146.
65. A. W. Armour, M. G. B. Drew, P. C. H. Mitchell, *J. Chem. Soc. Dalton Transactions* 1975, 1493.
66. M. T. Pope: *Heteropoly and Isopoly Oxometalates*, Springer Verlag, Berlin 1983.
67. J. B. Black et al., *Polyhedron* 5 (1986) 141.
68. P. C. H. Mitchell, *Wear* 100 (1984) 281.
69. See ref. [38] p. 1046.
70. D. H. Killefer, A. Linz: *Molybdenum Compounds, Their Chemistry and Technology*, Interscience, New York 1952.
71. O. Weisser, S. Landa: *Sulfide Catalysts, Their Properties and Applications*, Pergamon Press, New York 1973.
72. F. J. Clauss: *Solid Lubricants and Self-Lubricating Solids*, Academic Press, New York 1972.
73. T. J. Risdon: *Properties of Molybdenum Disulfide*, Bulletin C-5c, AMAX Mineral Sales, AMAX Inc., Greenwich, Connecticut, February 1987.
74. J. W. Lyons: *The Chemistry and Uses of Fire Retardants*, Wiley Interscience, New York 1970.
75. R. J. Cole, P. C. H. Mitchell: *Molybdenum Compounds in the Paint and Allied Industries*, Bulletin of Climax Molybdenum Co., AMAX Inc., Greenwich, Connecticut 1971.
76. *Molybdenum Catalyst Bibliography*, Bulletins C-40, C-54, C-73, C-77, C-96, C-111, C-119, C-130, C-135, C-139, Climax Molybdenum Co., AMAX Inc., Greenwich, Connecticut 1950-1983.
77. J. Haber: *The Role of Molybdenum in Catalysis*, Bulletin of Climax Molybdenum Co. Ltd., London, AMAX Inc., Greenwich, Connecticut 1981, pp 3-4.
78. F. Veatch, J. L. Callahan, J. D. Idol, Jr., E. C. Milberger, *Chem. Eng. Prog.* 56 (1960) no. 10, 65-67.
79. H. Adkins, W. Peterson, *J. Am. Chem. Soc.* 53 (1931) 1512-1516.
80. W. F. Jamison, *ASLE Trans.* 15 (1972) 296-305.
81. E. R. Braithwaite, *Sci. Lubr.* 18 (1966) 13-18.
82. W. O. Winer, *Wear* 10 (1967) 422-452.
83. J. P. G. Farr, *Wear* 35 (1975) 1-22.
84. R. S. Barnett: *Molybdenum Disulfide as an Additive for Lubricating Greases*, Bulletin of Climax Molybdenum Co., AMAX Inc., Greenwich, Connecticut 1981.
85. R. D. Loban, D. A. Gresty: *Molybdenum Disulfide in Rubber*, Bulletin of Climax Molybdenum Co., AMAX Inc., Greenwich, Connecticut 1976.
86. R. L. Johnson: *Bonded Lubricant Coatings - A Status Report*, Bulletin of Climax Molybdenum Co., AMAX Inc., Greenwich, Connecticut 1979.
87. T. J. Risdon, D. A. Gresty: *An Historical Review of Reductions in Fuel Consumption of United States and European Engines with MoS<sub>2</sub>*, SAE Paper No. 750674, Houston, Texas, June 1975.
88. P. C. H. Mitchell, *Wear* 100 (1984) 281-300.

89. Carbide and Carbon Chemicals Corp., US 2147395, 1939 (A. L. Bayes).
90. Carbide and Carbon Chemicals Corp., US 2147409, 1939 (H. Lamprey).
91. M. S. Vukasovich, J. P. G. Farr, *Mater. Perform.* 25 (1986) no. 5, 9 18.
92. M. S. Vukasovich: *Molybdate - The Versatile Inhibitor*, NACE Paper No. 444, NACE, New Orleans, LA, April 1989.
93. L. C. Rowe, R. L. Chance, M. S. Walker, *Mater. Perform.* 22 (1983) no. 6, 17-23.
94. H. O. Schoen, B. G. Brand, *Off. Dig. Fed. Soc. Paint Technol.* 32 (1960) 1522-1543.
95. The Sherwin Williams Co., US 3353979, 1967 (J. V. Hunn).
96. The Sherwin Williams Co., US 3677783, 1972 (T. Kirkpatrick, J. J. Nilles).
97. American Metal Climax Inc., US 3726694, 1973 (F. W. Moore, D. R. Robitaille, H. F. Barry).
98. T. R. Truax, C. A. Harrison, R. H., Baechler, *Proc. Annu. Meet. Am. Wood Preserv. Assoc.* 231 (1933) 107-123.
99. J. E. Ramsbottom: *The Fireproofing of Fabrics*, His Majesty's Stationery Office, London 1947.
100. F. W. Moore, G. A. Tsigdinos: "The Role of Molybdenum in Flame Retardancy and Smoke Retardation", in P. C. H. Mitchell, A. Seaman (eds.): *Proc. 2nd Intl. Conf. Chemistry and Uses of Molybdenum*, Climax Molybdenum Co., AMAX Inc., Greenwich, Connecticut 1976, pp. 145-149.
101. F. W. Moore, G. A. Tsigdinos: "Advances in the Use of Molybdenum Additives as Smoke Suppressants and Flame Retardants for Polyvinyl Chloride", *Proc. Intl. Symp. Flammability and Fire Retardants*, Technomic Press, Westport, Connecticut 1978, pp. 160-172.
102. M. Das, P. J. Haines, T. J. Lever, G. A. Skinner: "The Role of Molybdenum Trioxide as a Flame Retardant and Smoke Suppressant in Halogenated Polyester Thermosets", in H. F. Barry, P. C. H. Mitchell (eds.): *Proc. 4th Intl. Conf. Chemistry and Uses of Molybdenum*, Climax Molybdenum Co., AMAX Inc., Greenwich, Connecticut 1982, pp. 218-223.
103. F. Hund, *Farbe + Lack* 73 (1967) 111-120.
104. H. Schäfer, *Farbe + Lack* 77 (1971) no. 11, 1081-1089.
105. Hoechst, DE-OS 2127279, 1971 (R. Kohlhaas et al.).
106. Hoechst, DE-OS 2062775, 1970 (R. Kohlhaas et al.).
107. Sherwin-Williams, US 2237104, 1938 (N. F. Livingston).
108. J. F. Clay & Cromford Color, GB 730176, 1951; H. Lesche, *Farbe + Lack* 65 (1959) 79, 80.
109. Du Pont, US 2808339, 1957 (J. J. Jackson).
110. Du Pont, DE-OS 1807891, 1969 (H. R. Linton).
111. Bayer, DE-OS 1952538, 1969 (C. H. Elstermann, F. Hund).
112. ICI, DE-OS 2049519, 1970 (Ch. H. Buckley, G. L. Collier, J. B. Mitchell).
113. Ten Horn Pigment, DE-OS 2600365, 1976 (J. J. Einerhand et al.).
114. BASF, DE 3323247 A1, 1983 (E. Liedek et al.).
115. Heubach, DE 3806214 A1, 1988 (I. Ressler, W. Horn, G. Adrian).
116. Heubach, DE 3906670 A1, 1989 (I. Ressler, W. Horn, G. Adrian).
117. G. Meyer, *DEFAZET Dtsch. Farben Z.* 5 (1963) 201-205.
118. Sherwin-Williams Chemicals: *Moly White*, company information, Coffeyville, KS 1986.
119. W. J. Banke, *Mod. Paint Coat.* 70 (1980) Febr., 45-47.
120. American Metal Climax, CH 602899, 1973 (D. R. Robitaille et al.); DE 2334541, 1973 (D. R. Robitaille et al.).
121. Noranda Miners Ltd., US 4132667, 1977 (D. Kerfoot); DE 2814454, 1978 (D. Kerfoot).
122. J. Ruf, *Farbe + Lack* 79 (1973) no. 1, 22-27.
123. A. I. Vogel: *Quantitative Inorganic Analysis*, 5th ed., Longman, London 1989.
124. R. A. Mostyn, A. F. Cunningham, *Anal. Chem.* 38 (1966) 121.
125. *Analytical Methods in Atomic Absorption Spectrophotometry*, Perkin Elmer Corp., Norwalk, Connecticut 1971.
126. M. D. Amos, J. B. Willis, *Spectrochim. Acta* 22 (1966) 1325.
127. D. J. David, *Analyst (London)* 86 (1961) 730.
128. D. M. Knight, M. K. Pyzyna, *Atomic Absorption Newsletter* 8 (1969) 129.
129. L. R. P. Butler, P. M. Mathews, *Anal. Chim. Acta* 36 (1966) 319.
130. D. Hutchinson, *Analyst (London)* 97 (1972) 118.
131. *Official Methods of Analysis*, 10th ed., Association of Official Agricultural Chemists, Washington, D.C. 1965.
132. W. R. Chappell, K. K. Peterson: *Molybdenum in the Environment*, vols. 1 and 2, Marcel Dekker, New York-Basel 1976.
133. C. F. Mills, I. Bremner, J. K. Chesters (eds.): "Trace Elements in Man and Animals", *Proc. Int. Symp. Trace Elem. Man Animals 5th*, Commonwealth Agricultural Bureaux, Farnham, United Kingdom 1985.
134. L. S. Hurley, C. L. Keen, B. Lonnerdal, R. B. Rucker (eds.): *Trace Elements in Man and Animals* 6, Plenum Press, New York-London 1988.
135. *Acute Toxicity of Sodium Molybdate to Bluegill (Lepomis macrochirus)*, Rainbow Trout (*Salmo gairdneri*), Fathead Minnow (*Pimephales promelas*), Channel Catfish (*Ictalurus punctatus*), Water Flea (*Daphnia magna*) and Scud (*Gammarus fasciatus*), Bioassay Report Submitted to Climax Molybdenum Company of Michigan, Bionomics, Inc., Wareham, MA, December 1973.
136. *Acute Toxicity of Ammonium Molybdate and Molybdic Trioxide to Bluegill (Lepomis macrochirus) and Rainbow Trout (Salmo gairdneri)*, Bioassay Report Submitted to AMAX, Inc., Bionomics, Inc., Wareham, MA, January 1975.
137. D. W. Knothe, Dr. G. G. Van Riper: "Acute Toxicity of Sodium Molybdate Dihydrate (Molyhibil 100) to Selected Saltwater Organisms", *Bull. of Environ. Contam. and Toxicol.* 40 (1988) 785.
138. O. J. Abbott: "The Toxicity of Ammonium Molybdate to Marine Invertebrates", *Marine Poll. Bull.* 8 (1977) no 9, 204-205.

139. Evaluation of Acute Effects of Sodium Molybdate on the Activated Sludge Process and on the Batch Anaerobic Sludge Digestion Process, Laboratory Report for AMAX Inc., Stearns Catalytic Corp., January 1985.
140. Acute Oral LD<sub>50</sub> Assay in Rats, FDRL ID: 81-0393 for AMAX Inc., Aug. 1981.
141. Acute Oral LD<sub>50</sub> Assay in Rats, FDRL ID: 81-0394 for AMAX Inc., Aug. 1981.
142. N. Irving Sax: *Dangerous Properties of Industrial Materials*, 6th ed., Van Nostrand Reinhold Co., New York 1984, p. 1953.
143. Acute Oral Toxicity in Rats of MoS<sub>3</sub>, FDRL ID: 9589A for AMAX Inc., Nov. 29, 1987.
144. Threshold Limit Values and Biological Exposure Indices for 1989-1990, American Conference of Governmental Industrial Hygienists, Cincinnati, Ohio 1990.
145. Emergency Planning and Community Right-to-Know Act of 1986, enacted by Public Law 99-499, October 17, 1986.
146. Wet Bodembescherming (Wbb), Soil Protection Act, The Netherlands 1988.
147. Council of the European Communities Directive, 76/464/EEC, May 4, 1976.
148. W. S. Ferguson, A. H. Lewis, S. J. Watson, *Nature (London)* **141** (1938) 553.
149. S. B. Hornick, D. E. Baker, S. B. Guss: "Crop Production and Animal Health Problems Associated with High Soil Molybdenum", Molybdenum in the Environment, vol. 2, Marcel Dekker, New York-Basel 1977.
150. L. Fairhall, R. Dunn, N. Sharpless, E. Pritchard: "The Toxicity of Molybdenum", *U.S. Public Health Bull.*, no. 293, 1945.
151. J. Johnson, K. Rajagopalan: "Molecular Basis of the Biological Function of Molybdenum", *J. Biol. Chem.* **249** (1974) 859-866.
152. L. Friburg, P. Boston, G. Nordberg, M. Piscator, K. Robert: *Molybdenum - A Toxicological Appraisal*, EPA 600/1-75-004, U S Environmental Protection Agency, Research Triangle Park, North Carolina 1975.
153. V. Kovalskii, G. Yarovaya, D. Schmayovyan: "Changes in Purine Metabolism in Humans and Animals Living in Biogeochemical Areas with High Molybdenum Concentrations", *Z. Obsc. Biol.* **22** (1961) 179.
154. R. Burrell, W. Roach, A. Shadwell: "Esophageal Cancer in the Bantu of the Transkei Associated with Mineral Deficiency in Garden Plants", *J. Natl. Cancer Inst.* **35** (1966) 201-209.
155. S. Yang et al.: "Molybdenum Deficiency and Esophageal Cancer in China", *Fed. Proc. Fed. Am. Soc. Exp. Biol.* **40** (1981) 918.
156. S. Yang, H. Wei, X. Luo, H. Sproat: "Effect of Molybdenum on N-Nitrososarcosine Ethyl Ester-Induced Carcinogenesis in Rats", *Fed. Proc. Fed. Am. Soc. Exp. Biol.* **41** (1982) 280.
157. S. Yang, X. Luo, H. Wei: "Inhibitory Effects of Molybdenum on Esophageal and Forestomach Carcinogenesis in Rats", *JNCI J. Natl. Cancer Inst.* **17** (1980) 75-80.
158. S. Yang, H. Wei, X. Luo: "Effects of Molybdenum and Tungsten on Mammary Carcinogenesis in S. D. Rats", *JNCI J. Natl. Cancer Inst.* **74** (1985) 469-473.
159. Y. Doesthale, C. Gopalan: "The Effect of Molybdenum Levels in Sorgham (Sorgham Vulgare Pers) on Uric Acid and Copper Excretion in Man", *Br. J. Nutr.* **31** (1974) 351-353.
160. W. Mertz: "Defining Trace Element Deficiencies and Toxicities in Man", *Molybdenum in the Environment*, vol. 1, Chap. 18, Marcel Dekker, New York 1976.
161. National Academy of Sciences: *Mineral Tolerance of Domestic Animals*, Washington, D.C. 1980.
162. G. Nordheim, G. Frostlie: "Copper Molybdenum Interactions in Relation to Chronic Copper Poisoning in Sheep in Norway", *Nutr. Rev. Suppl.* **1985**, 535-538.
163. A. Lesperance, G. Cook, V. Bohman, E. Jensen: "Interrelationship of Molybdenum and Certain Factors to the Development of the Molybdenum Toxicity Syndrome", *J. Animal Sci.* **25** (1966) 96-101.
164. N. Suttle: "Copper Deficiency in Ruminants; Recent Developments", *Vet. Rec.* **119** (1986) 519-522.
165. L. Arlington, G. Davis: "Molybdenum Toxicity in the Rabbit", *J. Nutr.* **51** (1953) 295.
166. Food and Drug Research Laboratories, Inc.: *Acute Oral LD<sub>50</sub> Assay in Rats for Molybdenum Trioxide Pure Grade*, Waverly, New York 1981.
167. O. Mogilevskaja: "Experimental Studies on the Effect on the organism of Rare, Dispersed and Other Metals and Their Compounds Used in Industry", in Z. I. Izraelson (ed.): *Toxicology of the Rare Metals*, Israel Program for Scientific Translations Ltd., Jerusalem 1967.
168. O. Akopajan: "Some Biological Shifts in the Bodies of Workers in Contact with Molybdenum Dust", *Second Scientific Conference on The Institute of Labor of Hygiene and Occupational Diseases on Problems of Labor Hygiene and Occupational Pathology*, Erevan 1963, pp. 103-106.
169. M. Avakjan: "A Dynamic Study of the Experimental Effect of Molybdenum on Some Metabolic Processes", *Scientific Session on Problems of Labor Hygiene and Occupational Pathology in the Chemical and Mining Industries*, Alastan, 1966.
170. S. Eolajan: "The Effects of Molybdenum on the Nervous System", *Z. Exp. Klin. Med.* **5** (1965) 70-73.
171. P. S. Walravens et al.: "Biochemical Abnormalities in Workers Exposed to Molybdenum Dust", *Arch. Environ. Health* **34** (1979) 302-308.

## 28 Niobium

JOACHIM ECKERT

28.1 Introduction	1403	28.6.1 Oxides	1408
28.2 History	1403	28.6.2 Halides	1409
28.3 Properties	1403	28.6.3 Carbides and Hard Materials	1409
28.4 Occurrence	1404	28.7 Niobium Metal	1411
28.5 Processing of Niobium Ores	1405	28.7.1 Reduction of Niobium Pentoxide	1411
28.5.1 Pyrochlore Concentrates	1405	28.7.2 Reduction of Halides	1411
28.5.2 Production of Niobium Oxide from Columbites and Tantalites	1405	28.7.3 Refining	1412
28.5.2.1 Extraction Processes	1405	28.7.4 Uses	1412
28.5.2.2 Chlorination	1406	28.8 Analysis	1413
28.6 Compounds	1408	28.9 Economic Aspects	1413
		28.10 References	1414

### 28.1 Introduction

Niobium, Nb, atomic number 41,  $A_r$  92.91, is also known as columbium, Cb, in the United States. There are many artificial radionuclides, but only one known natural nonradioactive isotope, <sup>93</sup>Nb. The electronic configuration of the ground state is  $4s^2 3d^6 4f^3 5s^2$ , which explains the existence of the oxidation states +2 to +5.

### 28.2 History

Niobium was discovered by HATCHETT in 1801 in the mineral columbite and was named columbium. In 1844 the name niobium was proposed by ROSE.

### 28.3 Properties

Some important physical properties of niobium metal are listed in Table 28.1 [1-3].

The mechanical properties like those of most refractory metals are influenced by the purity of the metal, the production method, and the mechanical treatment. Even small amounts of interstitial impurities increase the hardness and strength but reduce the ductility. Some important mechanical properties of commercial niobium are listed in Table 28.2 [4].

Table 28.1: Physical properties of niobium.

Density at 20 °C (g/cm <sup>3</sup> )	8.57
Crystal structure	body-centered cubic ( $a = 3.3 \times 10^{-10}$ m)
$m_p$ (°C)	2468 ± 10
$b_p$ (°C)	4927
Linear coefficient of thermal expansion (K <sup>-1</sup> )	$6.892 \times 10^{-6}$
Specific heat (kJ/kg <sup>-1</sup> K <sup>-1</sup> )	0.26
Latent heat of fusion (kJ/kg)	290
Latent heat of vaporization (kJ/kg)	7490
Thermal conductivity at 0 °C (W cm <sup>-1</sup> K <sup>-1</sup> )	0.533
Electrical resistivity (μΩ·cm)	15.22
Temperature coefficient (0-600 °C) (K <sup>-1</sup> )	0.0396
Electrochemical equivalent (mg/C)	0.19256
Standard electrode potential $E^0$ Nb/Nb <sup>5+</sup> (V)	-0.96
Magnetic susceptibility at 25 °C	$2.28 \times 10^{-6}$
Superconductivity $T_c$ (K)	9.13
Spectral emissivity at $650 \times 10^{-10}$ m (at 2003 K)	$2.28 \times 10^{-6}$
Ionization potential (eV)	6.67
Work function (eV)	4.01

Niobium is very resistant to most organic and inorganic acids, with the exception of HF, at temperatures up to 100 °C [1]. Concentrated sulfuric acid above 150 °C causes embrittlement. The resistance towards alkaline solutions is lower. Because niobium has a marked tendency to form oxides, hydrides, nitrides, and carbides, its use in air is limited to temperatures up to ca. 200 °C.

**Table 28.2:** Mechanical properties of niobium.

<i>Annealed niobium</i>	
Ultimate tensile strength	195 MPa
Yield strength	105 MPa
Elongation	30% +
Reduction in area	80% +
Hardness	60 HV
Poisson's ratio	0.38
Strain hardening exponent	0.24
Elastic modulus	
tension	103 GPa
shear	17.5 GPa
Ductile-brittle transition temperature	< 147 K
Recrystallization temperature	800–1000 °C
<i>Cold worked niobium</i>	
Ultimate tensile strength	585 MPa
Elongation	5%
Hardness	150 HV

## 28.4 Occurrence

Niobium occupies the 33rd place in order of natural abundance, being present in the earth's crust at 24 µg/g. It is thus more common than cobalt, molybdenum, or tantalum. The most important niobium mineral is pyrochlore, a compound with the general formula  $(Ca,Na)_{2-m}Nb_2O_6(O,OH,F)_{1-n} \cdot xH_2O$ . The lattice positions of Na and Ca can also be occupied by Ba, Sr, rare earths, Th, and U. The latter two elements are responsible for the radioactivity of some pyrochlore concentrates.

Two types of niobium ore deposits are known. In primary deposits, the pyrochlore is always interstratified in carbonatites. This is so in the Canadian deposits at Niobec and

**Table 28.3:** Niobium deposits [6].

Location	Capacity, 10 <sup>6</sup> kg Nb <sub>2</sub> O <sub>5</sub>	Ore grade	Reserves, 10 <sup>6</sup> t Nb <sub>2</sub> O <sub>5</sub>	Production, 10 <sup>6</sup> kg Nb <sub>2</sub> O <sub>5</sub>
Araxa, Brazil	24.75	3.0	500+	9.45
St. Honoré, Québec	3.15	0.7	11	3.15
Catalao, Brazil	2.48	1.5	50	2.48
Nigeria	0.9			
Thailand	0.45–0.9			
Zaire	pilot scale	2–3	extensive	0.23

**Table 28.4:** Chemical composition of the principal niobium-bearing materials, % [7].

Mineral	Nb <sub>2</sub> O <sub>5</sub>	Ta <sub>2</sub> O <sub>5</sub>	TiO <sub>2</sub>	Fe	MnO	SnO <sub>2</sub>
Pyrochlore, NaCaNb <sub>2</sub> O <sub>6</sub> F	40–65	2	1–6	2		
Columbite, (Fe,Mn)(Nb,Ta) <sub>2</sub> O <sub>6</sub>	40–75	1–40	0.5–3	10–20	2.6	2
Tantalocolumbite, (Fe,Mn)(Nb,Ta) <sub>2</sub> O <sub>6</sub>	25–60	20–50	0.5–3	10–20	2.6	2
Tantalite, (Fe,Mn)(Ta,Nb) <sub>2</sub> O <sub>6</sub>	2–40	42–84	0.5–3	10–20	2.6	2
Microlite, Ca <sub>2</sub> (Ta,Nb) <sub>2</sub> O <sub>6</sub> (OH,F)		60–70				

Oka, in which calciopyrochlore is interstratified in dolomite. The ore contains 0.5–0.7% niobium pentoxide. In the important secondary Brazilian deposits at Araxa and Catalao, the niobium content of the carbonate minerals has been considerably enriched by weathering. Here, the ore is present in combination with apatite, iron oxide, and barite and contains about 3% Nb<sub>2</sub>O<sub>5</sub>, 46% Fe<sub>2</sub>O<sub>3</sub>, 17–18% BaO, and 1.5% P as apatite [5]. Table 28.3 shows the average Nb<sub>2</sub>O<sub>5</sub> capacity, the production, and the reserves of various deposits [6]. In addition to the sources listed in Table 28.3, other, potential sources exist in Canada, Africa, Brazil, China, the United States, and the former Soviet Union.

The most commercially important deposits are in Brazil, Canada, Nigeria, and Zaire. World reserves are estimated to be 4.1 × 10<sup>6</sup> t Nb, of which 78% are in Brazil. The Canadian reserves are estimated at 0.12 × 10<sup>6</sup> t.

The second most important niobium mineral is columbite, (Fe,Mn)(Nb,Ta)<sub>2</sub>O<sub>6</sub>, in which niobium is nearly always present with tantalum. These ores are referred to as columbites if the Nb<sub>2</sub>O<sub>5</sub> content is greater than that of Ta<sub>2</sub>O<sub>5</sub>, otherwise as tantalites. Columbites and tantalites contain at least 60% combined pentoxides. These minerals occur as primary deposits in granites and pegmatites, or in alluvial secondary deposits. Table 28.4 lists the chemical compositions of various niobium and tantalum minerals [7].

Columbites are mined in Australia, Brazil, Nigeria, Malaysia, and Zaire. Since the discovery of the enormous deposits of pyrochlore in Brazil, world production of columbite has decreased considerably. This trend could change when the extraction of columbite as a by-product of tin extraction is started with the Pitinga deposits in Brazil [8]. The discovery of large deposits of pyrochlore in South Greenland (Motzfeld Center) was reported in 1986.

A further source of niobium is provided by tantalum–niobium slags from tin production, since columbites and tantalites are often associated with cassiterite; niobium and tantalum concentrate in the slags as oxides. The niobium and tantalum pentoxide content of various tin slags is given in Table 28.5 [9]. Niobium and tantalum are also found in rare minerals such as stibiocolumbites (Sb,Nb)TaO<sub>4</sub>, fergusonites (Re<sup>3+</sup>)NbO<sub>4</sub>, and euxenite Y(Nb,Ti)<sub>2</sub>O<sub>6</sub>. The last two of these, however, are of no commercial significance.

**Table 28.5:** Niobium and tantalum pentoxide content of various tin slags, % [9].

Country	Nb <sub>2</sub> O <sub>5</sub>	Ta <sub>2</sub> O <sub>5</sub>
Malaysia	4	4
Nigeria	14	4
Portugal	7	7
Singapore	3	2
Thailand	8	12
Zaire	5	9

## 28.5 Processing of Niobium Ores

### 28.5.1 Pyrochlore Concentrates

Concentrates containing 50–60% Nb<sub>2</sub>O<sub>5</sub> are obtained from pyrochlore-containing carbonatites or weathered ores by conventional beneficiation processes such as crushing, grinding, magnetic separation, and flotation. Brazilian concentrates (Araxa) are also treated chemically to remove lead, phosphorus, and sulfur. The raw concentrate is roasted in the presence of calcium chloride and calcium oxide in a rotary furnace at 800–900 °C, and the product is leached with hydrochloric acid. In

the case of Brazilian pyrochlore, this procedure also leads to replacement of barium by calcium [10].

Whereas pyrochlore from Araxa can be converted directly to ferroniobium, pyrochlore concentrates from other sources must first be chemically pretreated before niobium can be obtained. Some well-known processes are treatment with concentrated sulfuric acid or with molten soda. Reductive chlorination of pyrochlore at ca. 1000 °C produces volatile chlorides of niobium and other metals. These processes are, however, generally regarded as uneconomical. This is also true of the process in which digestion of pyrochlore with mixtures of hydrofluoric and sulfuric acids is followed by solvent extraction [11].

### 28.5.2 Production of Niobium Oxide from Columbites and Tantalites

#### 28.5.2.1 Extraction Processes

Niobium and tantalum always occur together in columbites and tantalites and must be separated not only from the other elements present but also from each other. The industrial separation of tantalum from niobium has long been carried out by the Maignac process of fractional crystallization of potassium heptafluorotantalate and potassium heptafluoroniobate [12]. This expensive process of precipitation and crystallization, which is also environmentally unacceptable, has been abandoned, together with the long established Fansteel process [12], in favor of processes based on solvent extraction.

Tantalite and columbite, either naturally occurring or synthetically produced as concentrates from tin slags [13, 14], are digested with hydrofluoric and sulfuric acids at elevated temperature. The accompanying elements are dissolved along with the tantalum and niobium, which form the complex heptafluorides H<sub>2</sub>TaF<sub>7</sub> and H<sub>2</sub>NbOF<sub>5</sub> or H<sub>2</sub>NbF<sub>7</sub>. After filtering off the insoluble residue (fluorides of alkaline earth and rare earth metals), the aqueous

solution of Ta–Nb in hydrofluoric acid is extracted in several continuously operated mixer-settlers with an organic solvent, e.g., methyl isobutyl ketone (MIBK) [15–17]. The complex fluorides of niobium and tantalum are extracted by the organic phase, whereas most of the impurities and other elements, such as iron, manganese, titanium, etc., remain in the aqueous phase. In practice,  $\text{Nb}_2\text{O}_5 + \text{Ta}_2\text{O}_5$  concentrations of 150–200 g/L in the organic phase are used. The organic phase is washed with 6–15 N sulfuric acid and then reextracted with water or dilute sulfuric acid to obtain the niobium. The aqueous phase takes up the complex fluoroniobate and free hydrofluoric acid, while the complex fluorotantalate remains dissolved in the organic phase. The aqueous niobium solution is reextracted with a small amount of MIBK to remove traces of tantalum. The resulting organic phase is returned to the combined tantalum niobium extraction stage. Gaseous or aqueous ammonia is added to the aqueous niobium solution to precipitate niobium oxide hydrate. Crystallization of  $\text{K}_2\text{NbF}_7$  can only be achieved in strong hydrofluoric acid solution; therefore, it is only carried out on a small scale because of the high costs arising from the increased consumption of hydrofluoric acid.

The tantalum is reextracted from the organic phase with water or dilute ammonia solution, and tantalum oxide hydrate is precipitated by ammonia, or potassium salts are added to produce  $\text{K}_2\text{TaF}_7$ , which is used in the production of tantalum metal.

The oxide hydrates are collected by filtration, dried, and calcined at up to 1100 °C. Variation of the conditions of precipitation, drying and calcination produces different particle sizes, giving oxides suitable for various applications. Depending on the quality requirements, the calcination is carried out in directly or indirectly heated chamber or rotary furnaces. The nature of the furnace lining has considerable influence on purity.

Sophisticated process control and optimization enable niobium and tantalum to be produced with high yield (> 95%) and purity (> 99.9%).

A number of alternative extraction media have been reported in the literature, most of which have never been used in industry, except for tributyl phosphate (TBP) [18] and tri-*n*-octylphosphine oxide (TOPO) [19].

Figure 28.1 shows the flow diagram of an industrial installation for the processing of tantalum niobium raw materials [20].

### 28.5.2.2 Chlorination

The chlorination process is a modern alternative to the extraction process. There are two versions: reductive chlorination of natural and synthetic raw materials, and chlorination of tantalum–niobium ferroalloys.

In reductive chlorination, the ore or concentrate is pelletized with coal/coke and pitch, dried, and reacted in a stream of chlorine at 900 °C. The nonvolatile alkaline earth metal chlorides remain behind, while the readily volatilized tetrachlorides of silicon, tin, titanium, the pentachlorides  $\text{NbCl}_5$  and  $\text{TaCl}_5$ , and  $\text{WOCl}_4$  are distilled off and fractionated. The waste gas, which contains large amounts of phosgene and chlorine, must be rigorously purified.

The chlorination of ferroalloys is much simpler and more economical [21, 22]. Ferro-niobium or ferroniobium tantalum are produced by the aluminothermic or electrothermic process, size reduced, and fed together with sodium chloride into a  $\text{NaCl}/\text{FeCl}_3$  melt. The chlorinating agent is  $\text{NaFeCl}_4$ . Chlorine is passed into the melt, continuously regenerating  $\text{NaFeCl}_4$ . The following overall reactions take place:

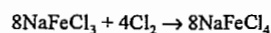
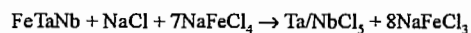

The reaction temperature of 500–600 °C is much lower than that required for reductive chlorination. The volatile chlorides are evolved from the molten salt bath. The boiling points of  $\text{NbCl}_5$ ,  $\text{TaCl}_5$ , and  $\text{WOCl}_4$  lie between 228 and 248 °C, and these compounds must therefore be separated by means of a distillation column.

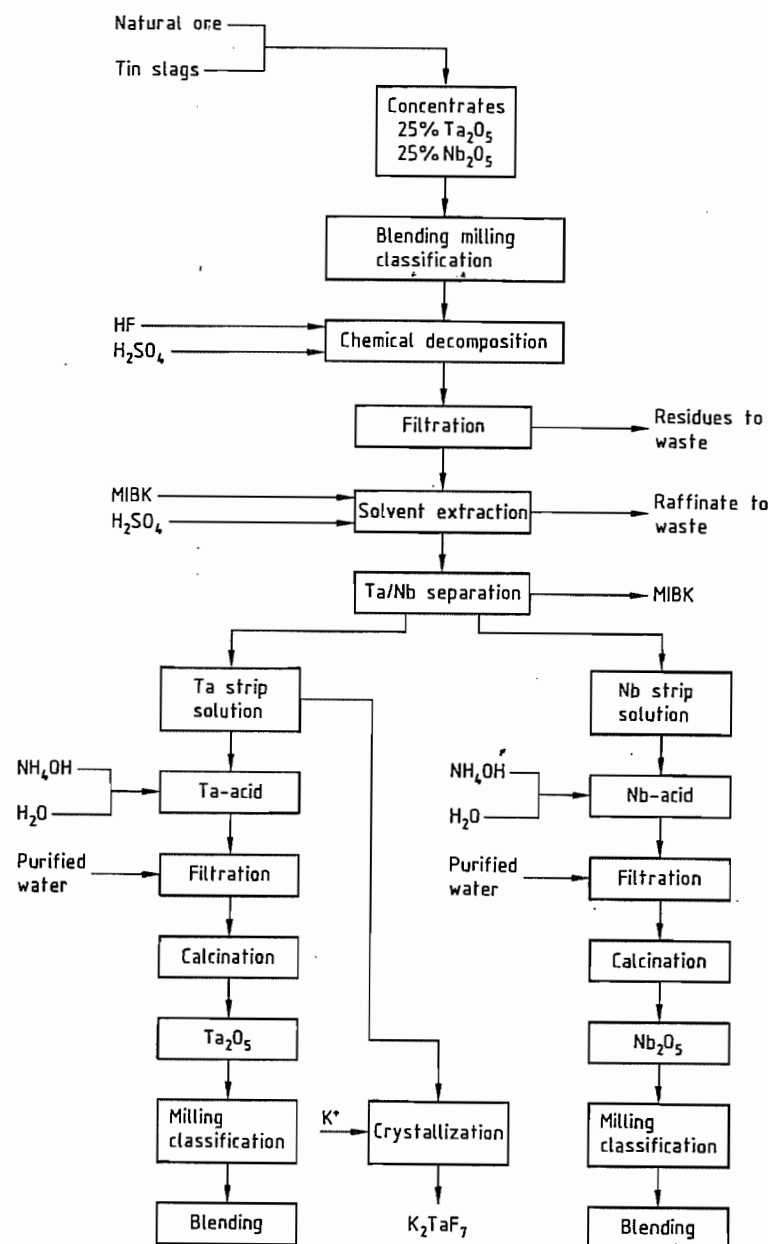

Figure 28.1: Flow diagram for the processing of tantalum–niobium raw materials [20].

The chlorination of ferroalloys produces very pure niobium pentachloride and tantalum pentachloride in tonnage quantities. The  $\text{NbCl}_5$  contains less than 30  $\mu\text{g/g}$  Ta, and other metallic impurities only amount to 1–2  $\mu\text{g/g}$ .

Niobium pentachloride is an intermediate in the production of oxides and organometallic compounds, and is the starting material for production of niobium powder and for chemical vapor deposition of niobium coatings.

Table 28.6: Commercially available niobium oxides [20].

Specification	Technically pure grade	Chemically pure grade	Ceramic grade	Grade HPO (high purity optical)	Grade UP (ultra pure)
Composition Nb <sub>2</sub> O <sub>5</sub>	min. 99%	min. 99.7%	min. 99.8%	min. 99.95%	min. 99.997%
Ta	max. 1600 ppm	max. 800 ppm	max. 500 ppm	max. 100 ppm	max. 8 ppm
Al				max. 2 ppm	max. 0.5 ppm
B					max. 0.2 ppm
Bi					max. 0.5 ppm
Ca	max. 700 ppm	max. 200 ppm		max. 10 ppm	max. 1 ppm
Cl					max. 10 ppm
Co				max. 2 ppm	max. 0.2 ppm
Cr				max. 2 ppm	max. 0.2 ppm
Cu				max. 2 ppm	max. 0.2 ppm
F					max. 1 ppm
Fe	max. 1000 ppm	max. 200 ppm	max. 100 ppm	max. 10 ppm	max. 1 ppm
K					max. 1 ppm
Mg					max. 0.5 ppm
Mn				max. 2 ppm	max. 0.2 ppm
Mo					max. 2 ppm
Na	max. 400 ppm	max. 200 ppm			max. 1 ppm
Ni			max. 100 ppm	max. 2 ppm	max. 0.2 ppm
Pb					max. 0.5 ppm
Rare earths					max. 1 ppm
S			max. 30 ppm		max. 1 ppm
Si	max. 1000 ppm	max. 250 ppm	max. 50 ppm	max. 50 ppm	max. 1 ppm
Sn					max. 0.5 ppm
Ti	max. 300 ppm	max. 100 ppm	max. 100 ppm		max. 1 ppm
V				max. 2 ppm	max. 0.5 ppm
W			max. 50 ppm		max. 1 ppm
Zr			max. 50 ppm		max. 1 ppm
Alkali			max. 200 ppm		
Loss on ignition	max. 1%	max. 0.5%	max. 0.4%	max. 0.2%	max. 0.005%
Average particle size (FSSS)	1–10 μm	0.5–10 μm	0.7–0.8 μm	max. 5 μm	1–3 μm
Tap density			0.8–1 g/cm <sup>3</sup>		0.8–1.25 g/cm <sup>3</sup>
Apparent density (Scott)			0.5–0.7 g/cm <sup>3</sup>		
Microtac analysis			90% < 1.2 μm 50% 0.7–0.8 μm 10% < 0.5 μm		
Grain size			1. < 600 μm HPO 600 2. < 400 μm HPO 400 3. < 150 μm HPO 150		< 255 μm
Crystal structure			orthorhombic (T-phase)	monoclinic (H-phase)	monoclinic (H-phase) + orthorhombic (T-phase)

## 28.6 Compounds

### 28.6.1 Oxides

Niobium pentoxide, niobic acid, Nb<sub>2</sub>O<sub>5</sub>, *mp* 265 °C, *bp* 1495 °C, is a colorless powder that can only be dissolved by fusion with acidic or alkaline fluxes such as NaOH or KHSO<sub>4</sub>, or in hydrofluoric acid. It is prepared by hydrolyz-

ing solutions of alkali-metal niobates, niobium alkoxides (e.g., Nb(OC<sub>2</sub>H<sub>5</sub>)<sub>5</sub>), or niobium pentachloride, or by precipitation from hydrofluoric acid solutions with alkali-metal hydroxides or ammonia. Depending on the method used, the oxide hydrate formed is either a gel that is difficult to filter or is flocculent. The oxide hydrate is filtered, washed, and calcined at 800–1100 °C. The temperature and treatment time

determine which of the various crystalline modifications is formed. Nearly all the phase changes are irreversible [23–25].

**Uses.** Niobium pentoxide is used in metallurgy, for the production of hard materials, in optics, and in electronics. Hydrated Nb<sub>2</sub>O<sub>5</sub>, which can be regarded as an isopolyacid, has a high surface acidity, and catalyzes the polymerization of alkenes, e.g., propylene [26].

Various applications require different qualities of Nb<sub>2</sub>O<sub>5</sub>. For the electrothermic and met-allothermic manufacture of niobium metal or its alloys, technical quality niobium pentoxide (> 98–99%) is suitable. For higher quality requirements, chemically pure niobium pentoxide (> 99.7%) is used.

In optics, niobium pentoxide is used as an additive to molten glass to prevent devitrification and to control properties such as refractive index and light absorption [27]. Optical-grade niobium pentoxide, with a purity of > 99.9%, must be free from colored impurities such as chromium, nickel, iron, manganese, etc.

Extremely stringent purity requirements apply to Nb<sub>2</sub>O<sub>5</sub> used in the manufacture of LiNbO<sub>3</sub> or KNbO<sub>3</sub> single crystals (Nb<sub>2</sub>O<sub>5</sub> ultra pure grade, > 99.995%). These compounds are used for electroacoustic and electrooptical components such as modulators, frequency doublers, and wave filters [28, 29].

Ceramic-grade niobium pentoxide, used for making dielectric materials, must be manufactured with a special particle size distribution. This market sector will demand greatly increased quantities of niobium pentoxide if the development of the new class of ferroelectric perovskites (relaxers) is successful, e.g., Pb(Mg<sub>1/3</sub>Nb<sub>2/3</sub>)O<sub>3</sub> for the manufacture of ceramic capacitors [30–32].

Details of the various commercial qualities of niobium pentoxide are given in Table 28.6 [20].

### 28.6.2 Halides

Niobium pentachloride, NbCl<sub>5</sub>, *M<sub>r</sub>* 270.2, *mp* 209.5 °C, *bp* 249 °C, is now produced ex-

clusively by chlorination of ferri-niobium, niobium metal, or niobium scrap (see Section 28.5.2.2.).

Niobium pentachloride forms strongly hygroscopic yellow crystals that react with water to form NbOCl<sub>3</sub> or Nb<sub>2</sub>O<sub>5</sub>·xH<sub>2</sub>O. The pentachloride is very soluble in dry ethanol, tetrahydrofuran, and benzene. Alcoholic solutions of niobium pentachloride are used in the production of niobium alkoxides such as the pentaethoxide, Nb(OC<sub>2</sub>H<sub>5</sub>)<sub>5</sub>, from which micronized niobium pentoxide is produced [33]. Pure niobium pentachloride is used for large scale production of niobium pentoxide and niobium metal.

Niobium tetrachloride, NbCl<sub>4</sub>, sublimes between 350 and 400 °C. Niobium trichloride, NbCl<sub>3</sub>, disproportionates between 900 and 1000 °C. Niobium trichloride and niobium dichloride, NbCl<sub>2</sub>, are formed by reduction of NbCl<sub>5</sub> with hydrogen, but are of no industrial importance.

Niobium oxychloride, NbOCl<sub>3</sub>, *M<sub>r</sub>* 215.28, is a colorless, crystalline compound that sublimes at 400 °C and partly decomposes into niobium pentoxide and niobium pentachloride on further heating.

Niobium pentafluoride NbF<sub>5</sub>, *M<sub>r</sub>* 187.91, *mp* 72 °C, *bp* 236 °C, can be prepared by fluorination of niobium pentachloride or niobium metal with fluorine or anhydrous HF. The reaction of Nb<sub>2</sub>O<sub>5</sub> with aqueous HF yields fluoro-niobic acids of various compositions (e.g., H<sub>2</sub>NbF<sub>7</sub> or H<sub>2</sub>NbOF<sub>5</sub>), depending on the acid concentration. They are soluble in organic solvents and consequently play an important part in the separation of tantalum from niobium by solvent extraction.

### 28.6.3 Carbides and Hard Materials

The carbides, borides, silicides, and nitrides of niobium are metallic hard materials [34]. Some of their physical properties are listed in Table 28.7. Only the carbides are commercially important.

Table 28.7: Physical properties of borides, carbides, nitrides, and silicides of niobium [34].

	Nb <sub>3</sub> B <sub>2</sub> tetragonal, U <sub>3</sub> Si <sub>2</sub> type	NbB orthorhombic, CrB type	Nb <sub>3</sub> B <sub>4</sub> orthorhombic, Ta <sub>3</sub> B <sub>4</sub> type	NbB <sub>2</sub> hexagonal, AlB <sub>2</sub> type	Nb <sub>2</sub> C hexagonal	NbC face-centered cubic, NaCl type	Nb <sub>2</sub> N hexagonal, W <sub>2</sub> C type	NbN face-centered cubic, NaCl type	Nb <sub>4</sub> Si hexagonal, ZrSi <sub>4</sub> type	Nb <sub>5</sub> Si <sub>3</sub> α-tetragonal, β-tetragonal	NbSi <sub>2</sub> hexagonal, CrSi <sub>2</sub> type
Crystal structure											
Density, g/cm <sup>3</sup>	8.0			6.6	7.83	7.78	8.33	8.2	7.74	6.26	5.45
Hardness <sup>a</sup>	2060	2200	2290	2600	2123	2400	2123	8 <sup>b</sup>	550	600	700
mp, °C	1860 (de-comp.)	2280	2700 (de-comp.)	3000	3100 (de-comp.)	3600			1950	2480	1950
Electrical resistivity, μΩ·cm		64.5		12/34		35		60	10	40	50.4
Superconductivity transition temperature, K		8.25	1.27	1.27	9.18	6		9.5	15.2	1.27	1.2

<sup>a</sup> Vickers hardness at 0.5 N loading.  
<sup>b</sup> Mohs hardness.

**Niobium Carbides.** The niobium-carbon phase diagram [35] indicates the existence of a face-centered cubic compound, NbC, which melts without decomposition at 3600 °C with a broad region of homogeneity, and of Nb<sub>2</sub>C, which has a peritectic melting point. Only NbC has practical applications. In addition to its original use as a grain growth inhibitor in tungsten carbide cobalt hard materials, it is now used mainly as solid solutions with titanium carbide, tantalum carbide, and tungsten carbide for cutting tools. The precise effect of niobium on the composition, microstructure, and properties of these hard materials is not yet fully understood [36]. In practice, up to 50% of the more expensive TaC can be replaced by NbC without appreciably affecting the hardness or fracture strength [37].

Production, like that of TaC, is by carburizing the oxide, hydride, or metal at 1500 °C in a carbon tube furnace, vacuum furnace, or in the presence of a molten metallic menstruum such as iron or aluminum. Some of the physical properties of niobium carbides are given in Table 28.7.

**Niobium Borides.** The niobium-boron phase diagram [38] shows the existence of Nb<sub>3</sub>B<sub>2</sub>, NbB, Nb<sub>3</sub>B<sub>4</sub>, and NbB<sub>2</sub>. However, these high-melting, very hard materials, have no industrial uses. Table 28.7 lists their physical properties.

**Niobium silicides,** Nb<sub>4</sub>Si, Nb<sub>5</sub>Si<sub>3</sub>, and NbSi<sub>2</sub>, are produced by the silicothermic reduction of Nb<sub>2</sub>O<sub>5</sub> or from the elements by sintering, pressure sintering, or fusion in an electric arc furnace. Some physical data are given in Table 28.7. These compounds are not used industrially.

**Niobium Nitrides.** Various nitride phases, with regions of homogeneity varying in distinctness, are obtained by heating niobium metal or mixtures of niobium oxide and carbon in a stream of ammonia or nitrogen [39]. Niobium metal can be produced by thermal decomposition of NbN in high vacuum. The pure nitrides have not as yet found any industrial application.

trial application. Table 28.7 lists some of the physical properties of niobium nitrides.

**Niobium Hydrides.** On heating niobium in a pure hydrogen atmosphere to 350–500 °C, hydrogen (ca. 44 atom%) is absorbed, causing expansion of the lattice and embrittlement. Apart from the NbH<sub>0.9</sub>, thus formed, the hydride Nb<sub>4</sub>H<sub>3</sub> [40, 41] and the unstable dihydride NbH [42] are also known.

The reversible uptake and release of hydrogen by NbH is used in industry as a means of producing niobium powder from compact niobium, e.g., scrap or ingots. The metal is first hydrogenated, then ground, and finally dehydrogenated in a vacuum furnace or under an inert gas.

## 28.7 Niobium Metal

The industrial production of niobium is usually carried out by the reduction of the pentoxide or halides. The crude metal is then refined electrothermally.

### 28.7.1 Reduction of Niobium Pentoxide

Niobium pentoxide is reacted with carbon, aluminum, or silicon at high temperature. In the carbothermic process, niobium pentoxide is mixed with carbon black, and the mixture is pelletized and reduced in a vacuum furnace in a two-stage process at 1950 °C:

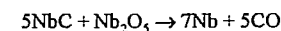
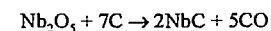

The reaction takes place with the formation of NbC, Nb<sub>2</sub>C, NbO<sub>2</sub> and NbO [43, 44]. A crude product containing oxygen and carbon is produced, which must be refined in further high-temperature processes.

The following one-stage carbonitrothermic reduction of niobium pentoxide has been successfully carried out on the pilot-plant scale. A pelletized mixture of niobium pentoxide and carbon black is reacted in a stream of ammonia in an induction furnace at 1570 ± 20 °C to form niobium nitride, NbN, which is then thermally decomposed in high vacuum at

2000–2100 °C. However, the process does not yet appear to have been used on an industrial scale [45, 46].

Over 90% of niobium metal is produced by aluminothermic reduction:

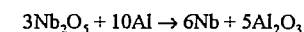

Niobium metal produced by this process is designated ATR niobium. In general, an excess of aluminum is used, producing a niobium-aluminum alloy which is melted in a vacuum, electric arc, or electron beam furnace to produce low-oxygen, carbon-free niobium [47, 48]. The amount of excess aluminum determines the yield of niobium and its oxygen content [49].

The silicothermic reduction of niobium pentoxide can lead to silicide formation, and the thermodynamics of this reaction are less favorable. This process is therefore not in regular use.

### 28.7.2 Reduction of Halides

The reduction of niobium pentachloride can be achieved with hydrogen at 600–650 °C [50]. Alternatively, niobium pentachloride vapor is reduced with hydrogen in a fluidized bed furnace at 750–1050 °C [51] or in a hydrogen plasma above 2000 °C [52]. Metallothermic reduction with sodium or magnesium has also been reported [53]. The company TOHO Titanium Corporation has commissioned a plant with a capacity of 30 t/a niobium in which niobium pentachloride is reduced by magnesium [54]. A reduction process with zinc using the auxiliary metal bath technique is also known [55]. In contrast to the production of tantalum, the reduction of the fluoroniobates K<sub>2</sub>NbF<sub>7</sub> and K<sub>2</sub>NbOF<sub>5</sub> has not become industrially significant.

Very pure niobium can be obtained by electrowinning from oxygen-free molten salt systems with double fluorides or chlorides as the source of metal [56]. These molten salts are very corrosive and the current efficiencies are low. For these reasons, molten salt electrowinning of metallic niobium is not carried out commercially.



### 28.7.3 Refining

Crude niobium must be refined in order to remove impurities introduced either from the raw materials or during the treatment stages.

Purification can be achieved by high-temperature treatment because the melting point of niobium (2497 °C) is so high that most other elements can be removed by vaporization. Niobium is extremely reactive towards all but the inert gases [57], and melting must therefore always be carried out in a high or ultra-high vacuum or under a pure inert gas to minimize the concentration of harmful interstitial foreign atoms.

In comparison to the classical sintering and electric arc melting processes, electron beam melting (EBM) has considerable technical advantages for the production of pure metal.

The vaporization of the impurities can be controlled in each melting cycle [58, 59]:

- by optimizing the melting rate,
- by maintaining the bath in a liquid state for a long period, and
- by controlled superheating of the molten metal.

Sufficient refinement cannot be achieved with one melting cycle only, so that in practice the solid ingot produced must be remelted. The melting rate (kg/h Nb) for the first melt (main refining step) depends on the raw material and is lower for ATR niobium because of the high content of aluminum and NbO that must be evaporated compared with compacted granular niobium. Further development of the plasma melting technique would enable a simple plasma furnace to be used for the first melting operation [60, 61]. In the second and third melting cycles, the melting rate can be increased by a factor of 3–4, depending on the specification of the material.

Optimization of the equipment used in the electron beam melting process, leading to reduction in residual gas pressure and leakage rate, has enabled standard quality niobium to be produced from ATR niobium on a large scale with only two melting cycles [62].

The electron beam melting and remelting technique enables niobium metal with less than 50 µg/g interstitial impurities to be produced for high-frequency superconductors. Figure 28.2 shows the concentration of interstitial impurities (O, N, and C) as a function of the number of melting cycles [63].

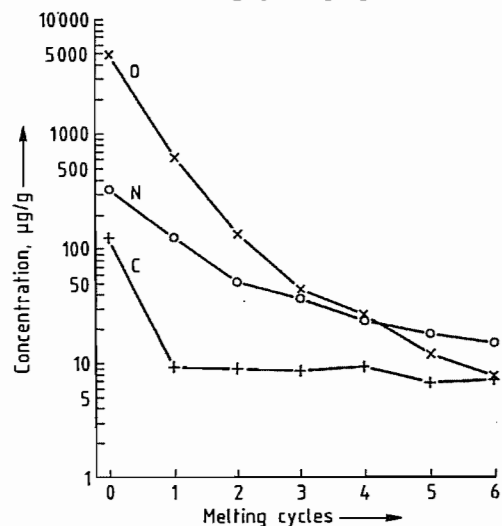

Figure 28.2: Contents of interstitial impurities (O, N, and C) of an electron beam melted niobium ingot as a function of the number of melting cycles [63].

Ultra-high-purity niobium can be obtained from metal melted by the EBM method by a series of additional sophisticated process steps, including electrorefining and electron beam zone melting, followed by high-temperature treatment in high vacuum. By these methods, niobium metal can be prepared with metallic impurities in the parts per billion range and with interstitial impurities < 1 ppm [64].

### 28.7.4 Uses

Niobium has good resistance towards corrosive chemicals [4, 65] even at high temperatures, and is therefore used in the construction of chemical equipment, though it is not quite so resistant as tantalum. The process of oxide dispersion hardening of niobium with titanium dioxide gives a material which can be used both for chemical equipment and for medical

implants subjected to high mechanical loading [66]. High-niobium alloys such as KBI 40/41 [67] can also be used under these conditions, for which formerly the more expensive metal tantalum had to be used.

Because niobium has a low neutron capture cross section and is unusually resistant towards corrosion by liquid sodium, it is used in the pure state or as the alloy NbZr1 in the nuclear industry for the production of fuel element cans. This alloy is also used for the sealing caps of sodium vapor lamps.

World consumption of niobium for the production of superconducting materials, such as Nb<sub>3</sub>Sn and NbTi is estimated to be 60–70 t/a.

The addition of niobium to titanium–aluminum alloys imparts the ductility needed to fabricate this material for the aircraft and space industry [68].

Other newly developed alloys C 103 (NbHf10Ti1) and Nb 752 (NbW10Zr25) combined with a special coating technique enable niobium to be used in the manufacture of nozzles and combustion chambers for rocket propulsion [69].

## 28.8 Analysis

Extensive literature on the analytical determination of niobium is available in handbooks and monographs [70–73].

The determination of niobium in raw materials is carried out by X-ray fluorescence [72, 74, 75]. For this purpose, test pieces in tablet form are produced by reacting the niobium-containing material with borate to produce a melt, or by compressing it with binders such as wax or boric acid.

For ferroniobium, X-ray fluorescence analysis of HF solutions [76] or borate tablets is used. For umpire assay, it is usual to separate the niobium from the other material using ion-exchange resins with HF solutions, followed by gravimetric determination [77]. Small niobium contents in steels are determined photometrically [78].

Metallic impurities in niobium pentoxide or niobium metal are determined by atomic ab-

sorption spectrometry (AAS) or atomic emission spectrometry (ICP-OES, DCP-OES) in HF solution [79]. Emission spectrum analysis in a d.c. current plasma arc is also used. The nonmetals oxygen, nitrogen, hydrogen, carbon, and sulfur are determined by extraction at high temperature either with a carrier gas or under vacuum, or by combustion analysis in a stream of oxygen [80]. The hydride-forming elements arsenic, antimony, bismuth, selenium, and tellurium can be converted to their hydrides and detected with high sensitivity by the AAS method. The anions Cl<sup>-</sup> and F<sup>-</sup> are separated by distillation and determined photometrically, by ion-selective electrodes, or by ion chromatography.

In all the above-mentioned methods, the usual limits of detection are from the low µg/g region down to the ng/g region in routine quality testing. For the analysis of ng/g trace impurities it is necessary to separate and concentrate the material [81, 82]. The final determination is carried out using AAS with a graphite furnace, ICP-OES, DCP-OES, or voltammetry. Recently, ICP mass spectrometry has become a powerful additional method for many metallic impurities. Niobium metal is analyzed simply and quickly for metallic and nonmetallic impurities down to the lower ng/g region by glow discharge mass spectrometry (GDMS) [83]. The additional techniques of neutron activation analysis [84, 85] or proton activation analysis [86] are used for verification.

## 28.9 Economic Aspects

The world consumption of niobium has, since 1980, reached 16–20 × 10<sup>6</sup> kg Nb<sub>2</sub>O<sub>5</sub>. The annual rate of increase is ca. 2%. More than 90% of total niobium production goes to the steel industry in the form of ferroniobium or niobium alloys, and therefore the demand for niobium is determined by the world market for iron and steel [87]. Figure 28.3 shows the clear relationship between steel production and niobium demand. Between 1984 and 1988, technical quality niobium pentoxide

was marketed in the price range \$14.3–15.2/kg. The price of standard grade ferroniobium is currently \$14.5/kg Nb. In mid 1987, the price of niobium concentrate (> 65% Nb<sub>2</sub>O<sub>5</sub> + Ta<sub>2</sub>O<sub>5</sub>, 10:1) was \$5.5–6.4/kg Nb<sub>2</sub>O<sub>5</sub> CIF Europe. Canadian pyrochlore concentrate was quoted at \$5.9/kg Nb<sub>2</sub>O<sub>5</sub> FOB.

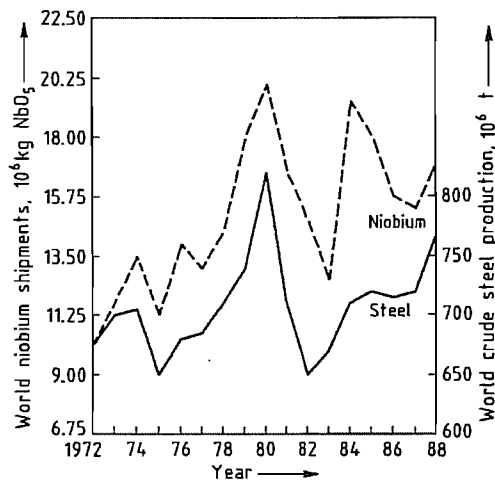

Figure 28.3: World niobium consumption compared to world crude steel production from 1972–1988 [87].

## 28.10 References

- R. Kieffer, H. Braun: Vanadin-Niob-Tantal, Springer Verlag, Berlin-Göttingen-Heidelberg 1963.
- I. Barin, O. Knacke: *Thermochemical Properties of Inorganic Substances*, Springer Verlag and Verlag Stahlisen GmbH, Düsseldorf 1973.
- C. English: "The Physical, Mechanical and Irradiation Behavior of Niobium and Niobium-Base Alloys" in H. Stuart (ed.): *Niobium-Proceedings of the International Symposium*, The Metallurgical Society of AIME, New York 1984, pp. 239–324.
- R.W. Balliett, M. Coscia, F. J. Hunkeler, *J. Met.* **38** (1986) no.9, 25–27.
- (J. Perrault, E. A. Manker: "Geology and Mineralogy of Niobium Deposits" in H. Stuart (ed.): *Niobium-Proceedings of the International Symposium*, New York 1984, pp. 3–77.
- Tantalum-Niobium International Study Centre Brussels: *Int. J. Refract. Hard Met.* **7** (1988) no.1, 3–7.
- Roskill: *The Economics of Niobium*, 5th ed., Roskill Information Services, London 1986, p. 1.
- Bureau of Mines, Miner. Yearbook, *Columbium and Tantalum*, 1987, p. 8.
- Roskill: *The Economics of Niobium*, 5th ed., Roskill Information Services, London 1986, p. 3.
- O. de Souza Paraiso, R. de Fuccio, *Min. Mag.* **146** (1982) no. 2, 134–147.
- G. Gabra: *CIM Bull.* **78** (1985) no. 873, 80–85.
- Ullmann, 4th ed., 17, 305, 306.
- H. C. Starck, DE 2733193, 1977 (B. Krismer, H. Pungs).
- W. Rockenbauer: "Production of Niobium-Metal and Compounds from Tantalite, Columbite Natural Ores and Synthetic Tantalum-Niobium Concentrates" in H. Stuart (ed.): *Niobium-Proceedings of the International Symposium*, New York 1984, pp. 133–152.
- K. B. Higbie, J. R. Werning: Bureau of Mines, Report of Investigations 5239 (1956).
- Gesellschaft für Elektrometallurgie, H. C. Starck, DE-AS 1018036, 1957 (F. Brenthel, H. Rothmann, W. Keil).
- Fansteel Metallurgical Corp., US 3117833, 1958 (J. A. Pierret).
- T. H. Tunley, M. Fieberg: National Institute for Metallurgy South Africa, Report 1154 (1976).
- Gesellschaft für Elektrometallurgie, DE 3241832, 1984 (G. Bauer, J. Eckert).
- Hermann C. Starck Berlin GmbH & Co. KG, Product Information, *Tantalum and Niobium Compounds*, 1986.
- H. C. Starck, US 3407031, 1970 (H. Fürer, W. Rockenbauer).
- W. Rockenbauer: *Metall (Berlin)* **38** (1984) no. 2, 156–159.
- H. Schäfer, R. Gruehn, F. Schulte, *Angew. Chem.* **78** (1966) 28–41.
- H. J. Goldschmidt, *J. Inst. Met.* **87** (1958–59) 235–239.
- H. Schäfer, A. Dürkop, M. Jori, *Z. Anorg. Allg. Chem.* **275** (1954) 289–296.
- K. Tanabe, *Mater. Chem. Phys.* **17** (1987) 217–225.
- T. Ichimura: "Niobium Oxide in Optical Glass Manufacture" in H. Stuart (ed.): *Niobium-Proceedings of the International Symposium*, New York 1984, pp. 603–614.
- A. Räuber: *Current Topics in Materials Science*, vol. 1, F. Kaldis, North Holland Publishing Company, Amsterdam 1978, pp. 481–601.
- T. Wearden, *New Electronics*, 20th Mar. 1984, 29–31.
- D. Hennings, *Keram. Z. Beilage* **41** (1989) 1–6.
- S. L. Swartz, T. R. Shrout, *Mater. Res. Bull.* **17** (1982) 1245–1250.
- TDK Electronics Co., Ltd.; US 4265668, 1981 (S. Fujiwara et al.).
- N. Salo, M. Nassju, *High Temp. Mater. Processes* **8** (1988) no. 1, 39–46.
- Ullmann, 4th ed., 12, 523.
- E. K. Storms: "Phase Carbides and Nitrides" in L. E. J. Roberts (ed.): *MTP International Review of Science*, vol. 10, Solid State Chemistry, Butterworths, London 1972.
- B. Aronsson, L. J. Aschan: "Niobium in Cemented Carbide" in H. Stuart (ed.): *Niobium-Proceedings of the International Symposium*, New York 1984, 637–652.
- R. Kieffer, F. Benesovsky: *Hartstoffe*, Springer Verlag, Wien 1963, pp. 127–135.
- R. Kieffer, F. Benesovsky: *Hartstoffe*, Springer Verlag, Wien 1963, p. 405.
- N. P. Lyakishev, N. A. Tulin, Yu. L. Pliner: *Niobium in Steels and Alloys*, Companhia Brasileira de Metalurgia e Mineracao-CBMM, Sao Paulo 1984, pp. 38–40.
- M. Hansen, K. Anderko: *Constitution of Binary Alloys*, 2nd ed., McGraw-Hill, New York 1958.
- R. P. Elliott: *Constitution of Binary Alloys*, 1st Suppl., McGraw-Hill, New York 1965.
- G. Brauer, H. Müller, *J. Inorg. Nucl. Chem.* **17** (1961) 102–107.
- J. Krüger: "Use of Vacuum Techniques in Extractive Metallurgy and Refining of Metals" in O. Winkler, R. Bakish (eds.): *Vacuum Metallurgy*, Elsevier, Amsterdam-London-New York 1971, pp. 145–173.
- N. P. Lyakishev, N. A. Tulin, Yu. L. Pliner: *Niobium in Steel and Alloys*, Companhia Brasileira de Metalurgia e Mineracao-CBMM, Sao Paulo 1984, pp. 87–101.
- N. Krishnamurthy, R. Venkataramani, S. P. Garg, *Int. J. Refract. Hard Met.* **4** (1984) no. 1, 41–45.
- C. K. Gupta, D. K. Bose, N. Krishnamurthy, *J. Less Common Met.* **139** (1988) 189–202.
- N. P. Lyakishev, N. A. Tulin, Yu. L. Pliner: *Niobium in Steel and Alloys*, Companhia Brasileira de Metalurgia e Mineracao-CBMM, Sao Paulo 1984, pp. 101–114.
- H. A. Wilhelm, F. A. Schmidt, T. G. Ellis, *J. Met.* **18** (1966) 1303–1308.
- G. R. Kamat, C. K. Gupta, *Metall. Trans.* **2** (1971) 2817–2823.
- Rio Algam Mines, GB 1054163, 1967.
- Du Pont de Nemours and Comp., GB 863310, 1957.
- R. M. Haire, E. Hade, D. M. Hiller, H. W. Jacobsen in R. M. Kibby (ed.): *The Design of Metal Producing Processes*, AIME, New York 1969, pp. 300–308.
- T. T. Campell, F. E. Block, G. B. Robidart, J. L. Schaller, Bureau of Mines Report of Investigations 6080, 1962.
- T. Sugai, R. Watanabe: "Extraction of Niobium Metal by Chlorine Process", *Proceedings of International Symposium on Tantalum and Niobium*, Tantalum-Niobium International Study Center, Brussels, Belgium 1988, pp. 241–254.
- G. Jangg, R. Kieffer, P. Topic, *Monatsh. Chem.* **100** (1969) 379–384.
- W. Rockenbauer, *Chem. Ing.-Tech.* **41** (1969) no. 4, 159–162.
- K. K. Schulze, H. A. Jehn, G. Hörz, *J. Met.* **40** (1988) no. 10, 25–31.
- W. W. Albrecht, D. P. Ingals: *Raffinationsverfahren in der Metallurgie*, VCH Verlagsgesellschaft, Weinheim 1983, pp. 230–241.
- K. Schulze, O. Bach, D. Lupton, F. Schreiber: "Purification of Niobium" in H. Stuart (ed.): *Niobium-Proceedings of the International Symposium*, New York 1984, pp. 163–223.
- M. P. Schlienger, R. C. Eschenbach: "Recent Developments in Plasma Melting of Reactive and Refractory Metals" in R. Bakish (ed.): *Proceedings of the Conference Electron Beam Melting and Refining*, New York 1987, pp. 149–156.
- K. Mimura, M. Nanjo, *High Temp. Mater. Processes* **8** (1988) no. 1, 29–38.
- E. Drost, M. Hormann, *Metall (Berlin)* **41** (1987) no. 4, 382–385.
- M. Hörmann, *J. Less Common Met.* **139** (1988) 1–14.
- K. K. Schulze, *J. Met.* **33** (1981) no. 5, 33–41.
- D. Lupton, F. Aldinger, K. Schulze: "Niobium in Corrosive Environments" in H. Stuart (ed.): *Niobium-Proceedings of the International Symposium*, New York 1984, pp. 533–560.
- U. Gennari, E. Kny, T. Gartner: "Niobium-Titanium Oxide Alloy", *Proceedings of the International Plansee Seminar* **89**, vol. 3, 1989, pp. 587–614.
- Tantalum Niobium International Study Center Brussels, Belgium: *TiC Bulletin* no. 46 (1986) 6–7.
- H. Inouye: "Niobium in High Temperature Applications" in H. Stuart (ed.): *Niobium-Proceedings of the International Symposium*, 1984, pp. 615–636.
- J. Lambert, "Aerospace brightens for Columbium, Tantalum + Columbium", Supplement to American Metal Market, New York 1988.
- R. Fresenius, G. Jander: *Handbuch der analytischen Chemie*, Part 3, "Quantitative Bestimmungs- und Trennungsmethoden", vol. 5b, "Elemente der 5. Gruppe. Vanadin, Niob, Tantal", Springer Verlag, Berlin 1957.
- O. G. Koch, C. A. Koch-Dedic: *Handbuch der Spurenanalyse*, Part 2, 2nd ed., Springer Verlag, 1974.
- R. W. Mosnier: *Analytical Chemistry of Niobium and Tantalum*, Pergamon Press, New York 1964.
- I. M. Gibaldo: *Analytical Chemistry of Niobium and Tantalum*, Ann Arbor, 1970.
- A. Knight: *TiC Bulletin*, no. 45, Tantalum-Niobium International Study Center, Brussels, Belgium, 1964.
- A. M. E. Balaes, K. Dixon, G. J. Wall, *Appl. Spectrosc.* **41** (1987) no. 3, 509–512.
- Analyse der Metalle*, "First Supplementary Volume: I Schiedsanalyse, II Betriebsanalyse", Springer Verlag, Berlin 1980.
- Annual Book of ASTM Standards*, "Metal Test Methods and Analytical Procedures", vol. 03.05, "Chemical Analysis of Metals and Metal Bearing Ores", Faston 1987.
- Handbuch für das Eisenhüttenlaboratorium*, vol. 5, Verlag Stahlisen GmbH, Düsseldorf 1973.
- H. M. Ortner, P. Wilhertz in Tantalum-Niobium International Study Center, Brussels (ed.): *TiC Bulletin*, no. 49 (1987).
- D. Hirschfeld (ed.): "Gase in Metallen", *Vortragstexte der Tagung Case in Metallen*, Deutsche Gesellschaft für Metallkunde, Darmstadt 1984.
- R. Caletka, V. Krivan, *Fresenius Z. Anal. Chem.* **311** (1982) 177–182.
- H. N. Hecker, *Fresenius Z. Anal. Chem.* **293** (1978) 110–114.
- N. E. Sanderson et al., *Microchim. Acta (Wien)*, (1987) 275–290.
- R. Caletka, W. G. Faix, V. Krivan, *J. Radioanal. Chem.* **72** (1982) no. 1–2, 109–130.
- W. G. Faix, R. Caletka, V. Krivan, *Anal. Chem.* **53** (1981) 1594–1598.
- V. Krivan, *Anal. Chem.* **47** (1975) no. 3, 469–478.

87. H. Stuart, F. Heisterkamp: "The Niobium Market – A Perspective", *Proceedings of International Symposium on Tantalum and Niobium*, Tantalum–Niobium International Study Center, Brussels, Belgium, 1988, pp. 71–89.

biom International Study Center, Brussels, Belgium, 1988, pp. 71–89.

## 29 Tantalum

KLAUS ANDERSSON, KARLHEINZ REICHERT, RÜDIGER WOLF

29.1 Introduction .....	1417	29.6 Metallic Tantalum .....	1421
29.2 History .....	1417	29.6.1 Production .....	1421
29.3 Properties .....	1417	29.6.2 Semifinished Products .....	1421
29.4 Occurrence .....	1418	29.6.3 Tantalum Powder for Capacitors .....	1422
29.5 Extraction .....	1418	29.6.4 Other Uses .....	1422
29.5.1 Extraction and Processing of Ore Concentrates .....	1418	29.7 Compounds .....	1423
29.5.2 Obtaining Ta–Nb Concentrates from Tin Slags .....	1418	29.8 Analysis .....	1425
29.5.3 Processing Tantalum Scrap .....	1420	29.9 Economic Aspects .....	1426
		29.10 Toxicology .....	1426
		29.11 References .....	1427

### 29.1 Introduction

Tantalum has the electronic structure  $1s^2 2s^2 2p^6 3s^2 3p^6 4s^2 3d^10 4p^4 5s^2 3d^3 6s^2$ , which accounts for its principal oxidation states 2+ and 5+. There are two naturally occurring isotopes:  $^{181}\text{Ta}$  and the weakly radioactive isotope  $^{180}\text{Ta}$  (0.012%, half-life ca.  $10^{13}$  years). A large number of artificial radioactive isotopes are also known.

### 29.2 History

Tantalum was discovered by EKEBERG in 1802 [1–2]. The discovery and history of tantalum and niobium are closely linked. The two elements usually occur together.

### 29.3 Properties

The physical properties of tantalum are as follows [1–7]:

Crystal structure	body-centered cubic
Lattice constant	$a = 0.33025 \text{ nm}$
Density	$16.6 \text{ g/cm}^3$
Melting point	$2996 \text{ }^\circ\text{C}$
Boiling point	$5425 \text{ }^\circ\text{C}$
Heat of fusion	$28.5 \text{ kJ/mol}$
Heat of vaporization at 3273 K	$78.1 \text{ kJ/mol}$
Specific heat capacity at 20 °C	$25.41 \text{ Jmol}^{-1}\text{K}^{-1}$
Linear coefficient of thermal expansion at 20 °C	$6.5 \times 10^{-6} \text{ K}^{-1}$
Thermal conductivity at 20 °C	$54.4 \text{ Wm}^{-1}\text{K}^{-1}$
Specific electrical conductivity	

at 20 °C	$0.081 \Omega^{-1}\text{cm}^{-1}$
Superconductivity	4.3 K
Temperature coefficient (0–100 °C)	0.00383

The effect of temperature on electrical and thermal conductivity has been accurately determined [3].

The mechanical properties of the metal are strongly dependent on its purity, structure, and crystal defects, as is the case with almost all refractory metals. Even low concentrations of interstitial impurities increase the hardness and reduce the ductility. The yield strength is strongly temperature dependent, the value at 200 °C being ca. 30% of that at 20 °C [3]. The important mechanical properties are as follows [1, 3, 7, 8]:

<i>Tantalum, soft annealed</i>	
Tensile strength	240 MPa
Yield strength (0.2% offset)	210 MPa
Breaking elongation	40%
Vickers hardness	60–120 HV
Modulus of elasticity	177–186 MPa
Ductile–brittle transition temperature	4 K
Poisson's ratio	0.35
<i>Tantalum, cold formed</i>	
Tensile strength	400–1400 MPa
Yield strength (0.2% offset)	300–900 MPa
Breaking elongation	2–20%
Vickers hardness	105–200 HV
Recrystallization temperature	1200–1500 K

Like niobium, tantalum has principal oxidation states 2+ and 5+. Below 100 °C, tantalum metal is extremely resistant to corrosion by most organic and inorganic acids, with the exception of hydrofluoric acid. This is due to a

dense adherent film of tantalum oxide, a characteristic which is utilized in the manufacture of electrolytic capacitors. Above ca. 300 °C, tantalum tends to form oxides, nitrides, hydrides, and carbides. All modern tantalum capacitor powders can be handled in air at temperatures up to ca. 100 °C. However, they are classified as flammable solids as they ignite at higher temperatures, forming Ta<sub>2</sub>O<sub>5</sub>.

**Table 29.1:** Tantalum deposits [11–15].

Location	Reserves, 10 <sup>3</sup> kg Ta <sub>2</sub> O <sub>5</sub>	Production (1991, estimated), 10 <sup>3</sup> kg Ta <sub>2</sub> O <sub>5</sub>	Annual production capacity (estimated), 10 <sup>3</sup> kg Ta <sub>2</sub> O <sub>5</sub>
Australia	17 000	235	300
Brazil	18 000	100	245
Canada	3 000	80	130
Malaysia	2 000	80	130
Thailand	16 000	150	200
Africa	10 000	25	50
Russia	> 20 000	< 50	
China	17 000	100	200
Others	10 000	< 50	< 100

## 29.4 Occurrence

Tantalum is 54th in order of abundance of the elements in the Earth's crust (2.1 g/t). In many deposits, it occurs in association with the much more abundant niobium (24 g/t). The most important tantalum-containing minerals are tantalite, wodginite, microlite (the tantalum-rich end member of the pyrochlore series), and columbite [9]. The typical Ta<sub>2</sub>O<sub>5</sub> concentration in processable pegmatitic deposits, which represent the principal raw material potential, particularly in Australia, is < ca. 0.1%. The uranium- and thorium-containing minerals ytrotantalite, strueverite, euxenite, and samarskite are sometimes highly radioactive, which limits their workability [10]. An important potential reserve lies in a belt stretching from China to Indonesia via Thailand and Malaysia, and consists of cassiterite (SnO<sub>2</sub>) that contains some tantalum and niobium. During tin smelting, the tantalum and niobium become concentrated in the slag. The important deposits, with estimated current production capacities, are listed in Table 29.1, and the compositions of some tanta-

lum-containing minerals are given in Table 29.2.

## 29.5 Extraction

### 29.5.1 Extraction and Processing of Ore Concentrates

In the important Australian mines, the tantalum-containing minerals are present in finely divided form in hard pegmatitic rock. The rock is extracted by open-cast mining. Further processing, which is different from that used for the mainly niobium-containing deposits, is an initial size reduction to < 15 mm, followed by grinding in ball or rod mills to < 1 mm. Flotation is then carried out, and the soluble constituents are leached out from the concentrates. The latter are then dried, and the magnetic constituents are removed [18].

This ore concentrate, up to 40% Ta<sub>2</sub>O<sub>5</sub>, is dissolved in concentrated hydrofluoric acid, and is then separated from the niobium by extraction with methyl isobutyl ketone, so that the tantalum is obtained as H<sub>2</sub>TaF<sub>7</sub>. Potassium salts are added, and potassium heptafluorotantalate, K<sub>2</sub>TaF<sub>7</sub>, crystallizes out. This is reduced with sodium to metallic tantalum.

Major tantalum processing routes are summarized in Figure 29.1.

### 29.5.2 Obtaining Ta–Nb Concentrates from Tin Slags

Tantalum-containing tin slags represent an important source of tantalum; e.g., in 1980, ca. 50% of world demand was recovered from tin slags [19–21]. Owing to the low price of tin, its production is in continuous decline, so that the availability of tantalum-containing tin slags is decreasing. Moreover, the tantalum concentration in tin concentrates is also decreasing significantly. The fraction of the world demand for tantalum represented by Ta<sub>2</sub>O<sub>5</sub> in tin slags is expected to fluctuate around 20%. The price of tin is not likely to reach a level at which more tantalum-rich tin

ores from Thailand and Malaysia can be processed economically.

The tantalum content of these slags fluctuates widely. Bolivian slags do not contain tantalum, but those from Thailand can have tantalum content 15–16% Ta<sub>2</sub>O<sub>5</sub>. The Ta:Nb ratio varies from 1:0.4 (Thailand) to 1:3 (Nigeria).

The most important grades of slag have the following tantalum and niobium content [19–21]:

	Ta <sub>2</sub> O <sub>5</sub> , %	Nb <sub>2</sub> O <sub>5</sub> , %
<i>High-grade</i>		
Thailand	13–16	9–10
Zaire	11	10
Australia	10	5–6
<i>Medium-grade</i>		
Thailand	4–6	4
Malaysia	3–4	3–4
Nigeria	4–5	12
South Africa	6–8	8–9
<i>Low-grade</i>		
Malaysia	0.8–2.5	0.8 <sup>2</sup> –2.5
Thailand	0.5–1	0.2–0.8
Brazil	1–2.5	1–2.5
Singapore	1–1.5	1–1.5

**Table 29.2:** Composition of important tantalum-containing minerals [9, 16, 17].

Mineral	Composition	Ta <sub>2</sub> O <sub>5</sub> content, %	Nb <sub>2</sub> O <sub>5</sub> content, %
Tantalite	(Fe, Mn)Ta <sub>2</sub> O <sub>6</sub>	42–84	2–40
Microlite	(Na, Ca)(Ta, Nb) <sub>2</sub> O <sub>6</sub> F	60–70	5–10
Columbite	(Fe, Mn)(Nb, Ta) <sub>2</sub> O <sub>6</sub>	1–40	40–75
Wodginite	(Ta, Nb, Sn, Mn, Fe) <sub>16</sub> O <sub>32</sub>	45–56	3–15
Ytrotantalite	(Y, U, Ca)(Ta, Fe <sup>3+</sup> ) <sub>2</sub> O <sub>6</sub>	14–27	41–56
Fergusonite	(RE <sup>3+</sup> )(Ba, Ta) <sub>2</sub> O <sub>6</sub>	4–43	14–46
Strueverite	(Ti, Ta, Nb, Fe) <sub>2</sub> O <sub>4</sub>	7–13	9–14
Tapiolite	(Fe, Mn)(Nb, Ta) <sub>2</sub> O <sub>6</sub>	40–85	8–15
Euxenite	(Y, Ca, Ce, U, Th)(Nb, Ta, Ti) <sub>2</sub> O <sub>6</sub>	1–6	22–30
Samarskite	(Fe, Ca, U, Y, Ce) <sub>2</sub> (Nb, Ta) <sub>2</sub> O <sub>6</sub>	15–30	40–55

\*RE = rare earth element.

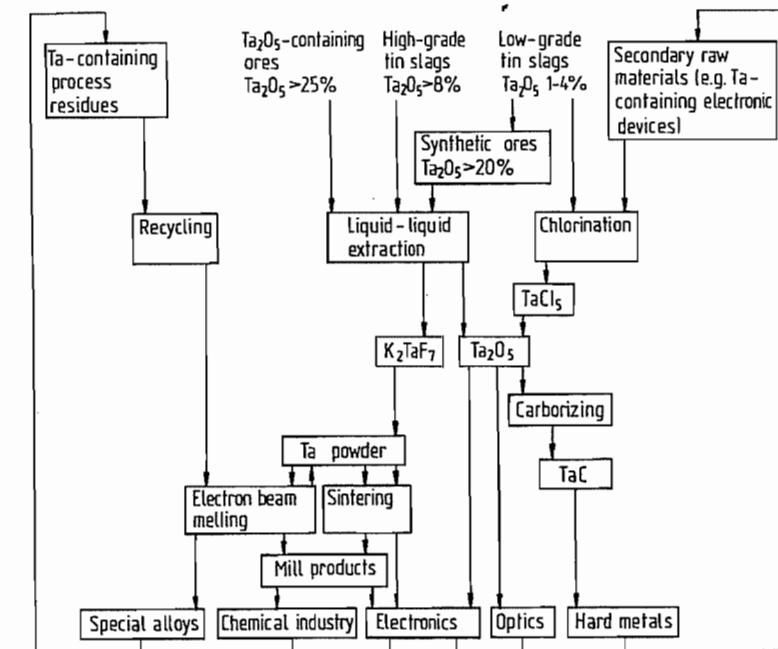

**Figure 29.1:** Major tantalum processing routes.

High-concentration slags are used directly in the wet chemical process (dissolution of the slag in hydrofluoric/sulfuric acid, followed by extraction and separation of tantalum and niobium).

From low-concentration slags, Ta/Nb concentrates containing 50–60% Ta<sub>2</sub>O<sub>5</sub>/Nb<sub>2</sub>O<sub>5</sub> can be produced, e.g., pyrometallurgically. The Ta/Nb content of these synthetic concentrates is > 99% soluble in hydrofluoric acid, as is the case with natural ores.

In all the concentration processes so far developed, the slag is first melted in an electric furnace with addition of reducing agents, e.g., coke, and fluxing materials. This causes the Ta/Nb to collect in the carbide-containing ferroalloy produced, while some impurities remain in the slag. The solid ferroalloy is produced in relatively large blocks, which must be broken up and ground. The tantalum/niobium content is increased in further process steps, giving a concentrate containing 50–60% oxides of tantalum and niobium.

One method of enriching the tantalum and niobium consists of oxidizing the ferroalloy, which contains the Ta/Nb carbide, with Fe<sub>2</sub>O<sub>3</sub> (e.g., as hematite). This causes undesired elements to be collected in the oxidic slag, while the Ta–Nb carbide is oxidized only as far as the metals and therefore remains in the metallic phase. In a final reaction stage, this is again oxidized with Fe<sub>2</sub>O<sub>3</sub> to form a slag that contains tantalum and niobium oxides [22].

The partial oxidation can also be carried out in a single smelting stage using air, oxygen-enriched air, or pure oxygen. Under these conditions, the tantalum is converted to slag much more rapidly than the niobium, enabling the tantalum to be concentrated at the expense of niobium [23]. Ta/Nb carbide-containing ferroalloy can also be treated by wet leaching processes [24–26].

### 29.5.3 Processing Tantalum Scrap

When processing tantalum-containing waste materials, physical and chemical processes are used as much as possible, avoiding processes typically used in ore treatment, i.e.,

dissolution in hydrofluoric acid and solvent extraction. The tantalum scrap is divided into two categories which differ in difficulty of recycling:

- Scrap material of the first type can consist of pure unoxidized metallic tantalum, e.g., sintered tantalum powder pellets (anodes) from the manufacture of tantalum electrolytic capacitors, scrap foil, sheet, and wire, or of anodically oxidized sintered tantalum pellets containing 1.5–3% oxygen from capacitor manufacture and oxidized wire scrap arising from this process.

The following processing methods are commonly used for these scrap materials: ingot melting in an electron beam furnace, or conversion to brittle tantalum hydride, grinding, and dehydrogenation at > 600 °C in vacuo or under a protective gas to form metallic tantalum powder [1]. Alternatively, the ground tantalum hydride can be carburized with carbon black to form tantalum carbide [27].

The oxygen content of oxidized tantalum anodes can be reduced by deoxidation with magnesium or calcium to give high-grade scrap [28].

- Scrap of the second type consists of oxidized tantalum anodes coated with manganese dioxide or with conductive silver, or sometimes welded to nickel conductor wires. This category also includes faulty capacitors, in which the coated and welded tantalum anodes also have an encapsulation of synthetic resin or tinned brass. Pure oxidized tantalum anodes can be recovered from coated anodes and brass-encapsulated capacitors by successive treatments with nitric and hydrochloric acid. Resin-encapsulated capacitors require complex treatment. These can be coarsely size-reduced in grinding mills, the tantalum being recovered by density separation. Foreign metals are removed by treatment with nitric and hydrochloric acid, leaving a residue of oxidized tantalum anodes in granular form [29].

Another method has been described for the

treatment of tantalum anode scrap containing manganese dioxide. This can be directly reduced in an argon/hydrogen plasma and melted to pure tantalum [30]. If the scrap capacitor materials are resin free, the tantalum can be recovered as its pentachloride by chlorination [31].

Some types of tantalum scrap which contain other impurities are roasted to form the oxide, and treated like ore concentrates. These include condensates formed during the melting of tantalum ingots, scrapped alloy materials; impure sawings and turnings, flue dust, and sediments from the wash liquors from the sodium reduction of potassium heptafluorotantalate.

Hard metals that contain tantalum carbide can be attacked by roasting and treating with caustic soda solution [32], anodic oxidation [33], or melting with sodium nitrate [34], converting the tantalum to its oxide for further recovery treatment.

## 29.6 Metallic Tantalum

### 29.6.1 Production

Metallic tantalum products (powder, semi-finished products, ingots) are produced almost exclusively by reduction of potassium heptafluorotantalate with sodium [35, 36]:

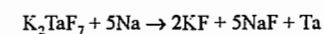

The strongly exothermic reaction is controlled by adding inert salts (KCl, NaCl, KF, NaF). The reduction can be carried out at constant temperature by controlled addition of one of the reactants, with controlled heat removal. Tantalum powder is recovered by leaching the salts out of the reaction product. Two processes are commonly used to obtain tantalum capacitor powder from this:

- The sodium-reduced metallic tantalum powder is purified and converted to a compactable and free-flowing product by further processing stages, e.g., high-temperature treatment in vacuo or under protective gas, deoxidation by magnesium [37], or a combination of these two processes [38]. Opti-

um properties for capacitor production are obtained by the addition of dopants to control sintering of porous pellets [39–41].

- During ingot melting of compressed slugs of tantalum powder in electron beam or electric arc furnaces [42], volatile impurities are driven off, usually in two smelting operations. The ingot can be ground after hydrogenation. The powdered tantalum “hydride” is then dehydrogenated in vacuo [1] and agglomerated by high-temperature treatment.

In addition to the sodium reduction process, other processes have been described, i.e., the molten salt electrolysis of K<sub>2</sub>TaF<sub>7</sub> with addition of Ta<sub>2</sub>O<sub>5</sub> or TaCl<sub>5</sub>, and hydrogen reduction of TaCl<sub>5</sub> [1, 43], but these have not achieved economic importance. The carbothermic reduction of Ta<sub>2</sub>O<sub>5</sub> in high vacuum [1, 4, 44] at ca. 1900 °C leads first to tantalum carbide:

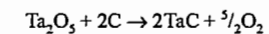

This reacts above 2000 °C with residual Ta<sub>2</sub>O<sub>5</sub> to metallic tantalum:

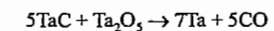

Because of the high quality standards for particle size and purity required by the producers of tantalum capacitors, this process is of minor importance.

### 29.6.2 Semifinished Products

Tantalum metal powder for producing semifinished products is also obtained by reducing K<sub>2</sub>TaF<sub>7</sub> with sodium. Semifinished products such as sheet, wire, and shaped articles are produced by two different methods:

- Powders are compacted, and then sintered by passing an electric current at ca. 2500 °C (Coolidge process) or indirectly by resistance or induction heating in vacuo. Tantalum wire for tantalum electrolytic capacitor manufacture is produced by this process. It is advantageous to control the grain size, e.g., by adding dopants [45], to optimize the mechanical properties.
- Bars produced by powder compression are formed into ingots by electron beam or elec-

tric arc melting, and shaped by forging, rolling, extruding, and wire drawing. Intermediate heat treatment in vacuo is usually unnecessary as tantalum does not work harden. After 95% deformation, a tantalum product has typical hardness 180 HV, after an initial ingot hardness of 80–90 HV [46, 47].

As well as its use for electrolytic capacitors (wire, cans, foil), semifinished tantalum is also used in the chemical industry because of its excellent resistance to corrosion by hot, concentrated mineral acids, with the exception of hydrofluoric acid which strongly attacks tantalum. The passivation of the metal is a result of the dense, adherent oxide film, 1–4 nm thick, which forms spontaneously in air and in acidic media, and which is stable up to ca. 260 °C [48]. Welding of tantalum sheet is mainly carried out by the tungsten inert gas process, which allows complex heat exchangers and intricate heating equipment to be fabricated [49]. Impurity levels in commercial semifinished tantalum products are listed in Table 29.3.

Because of the high price of tantalum, large vessels and pipework are often merely clad with the metal. Plating of steel with tantalum can be carried out by the explosion method [50], or corrosion protection can be achieved by build-up welding of tantalum [51].

**Table 29.3:** Typical chemical composition of commercial tantalum semifinished products.

	Powder metallurgy grade	Electron beam melted grade
Ta	≥99.9%	≥99.98%
Impurity content, ppm		
O	250	100
C	75	30
N	75	30
H	15	10
Nb	10	20
W	10	20
Mo	5	10
Fe	75	10
Cr	15	3
Ni	20	2
Na	10	1
K	10	1

### 29.6.3 Tantalum Powder for Capacitors

Since the first report that tantalum could be used for electrolytic capacitors [52], the growth of this application has been such that it now accounts for the highest consumption of the metal [53]. The capacitor consists of an anode of tantalum metal powder compressed into a pellet, typically 20–200 mg. This anode is sintered to give electrical continuity and density of ca. 6–9 g/cm<sup>3</sup>. The electrical connection is provided by a tantalum wire, attached by sintering or welding. The whole of the pore surface of the sintered anode is coated with an amorphous dielectric layer of Ta<sub>2</sub>O<sub>5</sub> by anodic oxidation, using an electrolyte of dilute H<sub>3</sub>PO<sub>4</sub>/H<sub>2</sub>SO<sub>4</sub>, sometimes with the addition of organic compounds [54, 55]. Ta<sub>2</sub>O<sub>5</sub> has a resistivity of ca. 10<sup>15</sup> Ωcm [56] and dielectric constant ε = 25. The anode is coated with a semiconducting layer of MnO<sub>2</sub> by impregnation with an aqueous solution of manganese nitrate, followed by pyrolysis. This solid electrolyte provides the cathodic contact. Research has been carried out into the effect of the pyrolysis temperature on the Ta<sub>2</sub>O<sub>5</sub> layer [57] and its dielectric properties [58], and also into the effect of temperature on the capacity [59] and conductivity [60–62], and the effect of these on the leakage current of the capacitor [63]. Progressive improvements to powder quality [64] have doubled the specific capacitance of the tantalum metal powder (the product of capacitance and formation voltage per unit mass) [65]. Typical qualities and properties of capacitor grade tantalum powder are given in Table 29.4.

### 29.6.4 Other Uses

Tantalum is used in medicine because of its lack of toxicity and very good compatibility with tissue. Reports and discussions have been published on the suitability of inhaled tantalum powder as a contrast medium in X-ray diagnostics of the throat, trachea, larynx, bronchi, esophagus, and stomach [66–68], but the material has been rarely used, mainly for

cost reasons. Small tantalum spheres or tantalum wires are used in organs (e.g., the heart), in bone, or in implants as markers when controlling position and function by X rays [69–71].

**Table 29.4:** Typical properties of capacitor-grade tantalum powder.

Chemical impurities, ppm	Powder from electron beam melting		Powder from sodium reduction	
	QR 7 <sup>a</sup>	QR 3 <sup>a</sup>	VFI-18 KT <sup>b</sup>	STA-30 KD <sup>c</sup>
O	800	1500	1800	2200
C	10	10	35	40
N	20	40	50	70
H	15	15	50	50
Nb	<20	<20	<10	<10
W	<20	<20	<10	<10
Fe	<10	<10	25	25
Cr	<5	<5	10	10
Ni	<5	<5	20	20
Na	<1	<1	<2	<2
K	<1	<1	5	10
Specific charge, C/V/g (μF V/g)	3000	5000	15000	30000
Application working voltage, V	50–75	35–50	25–35	<25

<sup>a</sup>H. C. Starck, Newton, United States.

<sup>b</sup>H. C. Starck-V-tech, Tokyo.

<sup>c</sup>H. C. Starck, Goslar, Germany.

Because of its stable oxide layer, tantalum in the body is completely bioinert. It has been shown in animal experiments that, if broken bones are held in position with tantalum rods, even in septic conditions with corrosive tissue reaction, healing is better than when chromium–nickel steel or niobium are used [72]. Tantalum implants in the jaw have shown good metal–bone contact over many years with no morbid reaction [73]. Tantalum has been largely replaced as a prosthetic implant material by titanium, as this has better strength properties and is sufficiently bioinert [74]. However, tantalum has an important use in clips for rapid occlusion of vessels in surgery, either temporary or permanent, [75–77]. In some cases, tantalum mesh and plate can be implanted in damaged areas of the skull [78–80].

The possible use of the very dense and ductile tantalum for the manufacture of heavy

missiles for armour penetration is under investigation [81].

## 29.7 Compounds

**Oxides.** Tantalum oxides in lower oxidation states are not industrially important. Tantalum(II) oxide, TaO, is the only lower oxide whose existence has been confirmed. It is produced from tantalum pentoxide by reduction with carbon at 1900 °C, or with hydrogen at 1100 °C. A possible use is for the production of heat-reflecting window glass [82].

No tantalum compound analogous to niobium(IV) oxide, NbO<sub>2</sub>, is known. However, with tantalum pentoxide, the possibility exists of introducing interstitial tantalum atoms, so that TaO<sub>x</sub> compounds can be obtained (x = 2–2.5). These oxides have metallic conductivity, but do not form discrete phases.

Tantalum pentoxide, Ta<sub>2</sub>O<sub>5</sub> (*mp* 1880 °C, density 8.73 g/cm<sup>3</sup>), occurs in two thermodynamically stable modifications, α and β. The transition temperature from the orthorhombic β modification to the tetragonal α modification is ca. 1360 °C. The existence of an ε modification, produced hydrothermally from tantalum acid at 300–340 °C, is also known. This ε-Ta<sub>2</sub>O<sub>5</sub> is isomorphous with β-Nb<sub>2</sub>O<sub>5</sub>, and is transformed to β-Ta<sub>2</sub>O<sub>5</sub> by heating in air above 886 °C [83].

Two processes are used for the manufacture of tantalum pentoxide:

**Wet Chemical Method.** The raw materials (ores and/or tin slag concentrates) are dissolved in hydrofluoric acid at ca. 100 °C. Tantalum and niobium are extracted from this strongly acid aqueous solution, preferably with methyl isobutyl ketone. The impurities that are also extracted, SiF<sub>6</sub><sup>2-</sup>, FeF<sub>6</sub><sup>3-</sup>, AlF<sub>6</sub><sup>3-</sup>, SbF<sub>6</sub><sup>2-</sup>, etc., are washed out with sulfuric acid, and the tantalum and niobium are separated in a multistage operation. Ammonia gas or solution is added to the aqueous H<sub>2</sub>TaF<sub>7</sub> solution, forming hydrated tantalum oxide, Ta<sub>2</sub>O<sub>5</sub>·nH<sub>2</sub>O. This is washed, dried, and calcined above 800 °C to form the oxide [84].

**Chloride Process.** The ferroalloy produced by the pyrometallurgical method is chlorinated in an iron chloride-sodium chloride melt at 550–600 °C. The complex salt  $\text{NaFeCl}_4$  present in the melt acts as a chlorine carrier. The iron loses a chlorine atom and is reduced from the trivalent to the divalent state, and the added chlorine gas causes the iron to be continuously reoxidized to Fe(III). The  $\text{TaCl}_3/\text{NbCl}_3$  mixture is separated by fractional distillation to obtain the chlorides of the two elements in a highly pure state. To obtain the oxide, the ground chlorides are hydrolyzed with steam in a fluidized bed, and then calcined.

In the optical industry, tantalum pentoxide is used in lanthanum borate glasses, characterized by their high refractive index and low optical scattering; since the 1980s, niobium pentoxide has been increasingly used for this application, as tantalum pentoxide is 3–5 times as expensive and has twice the density [85].

Tantalum pentoxide, and especially hydrated tantalum oxide  $\text{Ta}_2\text{O}_5 \cdot n\text{H}_2\text{O}$ , is used as an acid catalyst. In its amorphous form, its surface acidity can be as high as  $H_0 \leq 8.2$  [86]. It therefore has good catalytic activity for alkylation, esterification, Beckmann rearrangement, aldol condensation, etc. [87–90].

**Tantalates.** Tantalates can be produced by calcination of oxide mixtures, or by dissolving tantalum pentoxide in molten alkali metal hydroxides or carbonates. Excess alkali metal hydroxides or carbonates leads to the formation of water-soluble tantalate isopolyanions  $(\text{H}_x\text{Ta}_6\text{O}_{19})^{(8-x)-}$  where  $x = 0, 1, \text{ or } 2$  [91].

The most industrially important tantalates are those of lithium and yttrium. Single crystals of lithium tantalate,  $\text{LiTaO}_3$ , are pulled from the melt crucible by the Czochralski method [92]. The crystal growth rate for crystals 5–8 cm in diameter is ca. 2–3 mm/h. These ferroelectric single crystals in the unpoled state have domains that are statistically distributed in the crystal. They are poled on passing through the Curie temperature (665–618 °C) in an electric field and then have only

a single domain [93, 94]. Single-crystal wafers of  $\text{LiTaO}_3$  are widely used as surface acoustic wave filters (SAW) for high-frequency applications in communication systems (intermediate-frequency filters in television and video equipment). Also, lithium tantalate is used in combination with lithium niobate in the manufacture of waveguides, frequency doublers (second harmonic generation), optical modulators, and optical switches.

Yttrium tantalate powder,  $\text{YTaO}_4$ , produced in a solid state reaction, is applied as an emulsion to a film, and is used in diagnostic medicine as a phosphor for the amplification of X rays. It converts X rays to fluorescent light in very high yield, enabling the X-ray dose received by the patient to be significantly reduced [95].

Barium magnesium tantalate,  $\text{Ba}_3\text{MgTa}_2\text{O}_9$ , and barium zinc tantalate,  $\text{Ba}_3\text{ZnTa}_2\text{O}_9$ , are likely to play an increasingly important role in the future as the base material for microwave resonators for the stabilization of oscillators, or as frequency filters. These dielectric materials, which have the perovskite structure, have high dielectric constant and very low dielectric loss at high frequencies [96–99]. These high-quality resonators are especially necessary for the high carrier frequencies in satellite communication.

**Halides.** Tantalum pentafluoride,  $\text{TaF}_5$ , ( $mp$  96.8 °C,  $bp$  229.5 °C) is produced by passing fluorine over metallic tantalum, or from tantalum chloride by adding anhydrous hydrogen fluoride [100–102]. Both tantalum pentafluoride and niobium pentafluoride are used in the petrochemical industry as isomerization and alkylation catalysts. The fluorides of both elements are also useful as fluorination catalysts for the manufacture of fluorochloro- and fluorinated hydrocarbons [103].

The oxyfluorides  $\text{TaOF}_3$  and  $\text{TaO}_2\text{F}$  are also known, but have no industrial importance.

Potassium heptafluorotantalate (potassium tantalum fluoride),  $\text{K}_2\text{TaF}_7$ , is an industrially important intermediate in the production of tantalum metal. It crystallizes in colorless, rhombic needles when  $\text{K}^+$  ions (e.g.,  $\text{KCl}$  or

KF) are added to solutions of tantalum in hydrofluoric acid (e.g.,  $\text{H}_2\text{TaF}_7$  solution) from the extraction process. If the acidity is not high enough, undesired oxyfluorides are formed in addition to  $\text{K}_2\text{TaF}_7$ .

The solubility of potassium heptafluorotantalate in hydrofluoric acid solution decreases from 60 g/100 ml at the boiling point to < 0.5 g/100 ml at room temperature. As the corresponding stable niobium salt  $\text{K}_2\text{NbOF}_5$  is significantly more soluble, tantalum can also be separated from niobium by fractional crystallization (Marignac process) [7].

Tantalum pentachloride,  $\text{TaCl}_5$ ,  $mp$  216 °C,  $bp$  242 °C, forms colorless, strongly hygroscopic, needle-shaped crystals. On an industrial scale, production of this chloride is exclusively by chlorination of metallic tantalum, ferrotantalum, or tantalum metal scrap. This process is mainly used in the production of high-purity oxides [104, 105].

Tantalum pentachloride is soluble in absolute alcohol, with formation of the corresponding alkoxide [106, 108]. Ultrafine tantalum oxide powder can be produced by hydrolysis of this alkoxide [108].

Tantalum pentachloride and tantalum alkoxides are suitable for use in the chemical vapor deposition of tantalum metal or tantalum oxide.

The other pentahalides,  $\text{TaBr}_5$  and  $\text{TaI}_5$ , are known, but are of no industrial importance.

**Carbides.** Tantalum carbide,  $\text{TaC}$ , is golden-brown,  $mp$  3985 °C (one of the highest known). It is added as powder in the manufacture of hard metals. Tantalum carbide can be produced by the direct carburization of Ta metal by carbon, or preferably by reaction of  $\text{Ta}_2\text{O}_5$  with carbon at ca. 1900 °C. In hard metal mixtures based on tungsten carbide, tantalum carbide is present at concentrations 0.5–10%. It improves the high-temperature fatigue strength and thermal shock resistance of the cutting tool.

**Nitrides.** Tantalum nitride,  $\text{TaN}$ , is a hard material, like tantalum carbide, with good wear resistance. It is produced by heating tantalum in a pure nitrogen atmosphere at ca. 1100 °C.

Tantalum nitride films are used as diffusion barriers in semiconductor technology [109, 110], and as protective coatings for moisture sensors [111]. Tantalum nitride is also sometimes found in small amounts (3–8%) in cermet [base material  $\text{Ti(C, N)}$ ].

**Borides.** The tantalum–boron phase diagram [112] shows the existence of  $\text{Ta}_2\text{B}$ ,  $\text{Ta}_3\text{B}_2$ ,  $\text{TaB}$ ,  $\text{Ta}_3\text{B}_4$  and  $\text{TaB}_2$ . These hard materials are of little industrial importance. The borides may be produced by heating tantalum and boron in vacuo at ca. 1800 °C, or by electrolyzing a melt of  $\text{Ta}_2\text{O}_5$ ,  $\text{B}_2\text{O}_3$ ,  $\text{CaO}$ , and  $\text{CaF}_2$ .

**Silicides.** The silicides  $\text{TaSi}_2$  and  $\text{Ta}_5\text{Si}_3$  [113] are produced from the elements by heating in vacuo at 1000–1500 °C. Tantalum silicide targets were formerly used in the semiconductor industry for production of interconnections by sputtering [114], but tantalum silicides are no longer of any industrial importance.

## 29.8 Analysis

The analytical chemistry of tantalum is described in detail in several monographs [115–118]. Analysis for tantalum as a major or minor component or trace element in raw materials, ferroniobium–tantalum, scrap materials, and alloys must be distinguished from analysis for impurities in tantalum products. The classical method of analyzing for tantalum is by gravimetry after extraction as the fluoro complex on an ion-exchange resin [119]. Low concentrations, i.e., in the  $\mu\text{g/g}$  region, are usually determined photometrically [118].

When tantalum is a major or minor component in ores, scrap, etc., it is usually determined by fusion with sodium or lithium borate, followed by X-ray fluorescence analysis ( $\geq 0.01\%$  Ta) [120]. Analysis of solutions by emission spectrometry with plasma excitation (ICP-AES) is increasingly used. Tantalum in the  $\text{ng/ml}$  region can be determined by measurement at 296.5 nm.

Because of the high purity required for electronic components, optical glasses, and superalloys, sensitive multielement methods have been developed for the determination of

trace impurities in commercial products, e.g. potassium heptafluorotantalate, metallic tantalum, and tantalum oxide. The first methods were based on OES with vaporization in a carbon d.c. arc [121]. Additionally, many elements can be determined by plasma optical emission spectrometry (DCP-AES, ICP-AES) after dissolution by treatment with hydrofluoric or hydrofluoric/nitric acid under pressure [122]. Alkalis are determined by flame atomic absorption spectrometry, and arsenic, antimony, and other hydride formers by hydride techniques. Phosphorus, as a doping element in tantalum powders, can be very reliably determined photometrically [123]. Carbon and sulfur are determined by combustion analysis, and oxygen and nitrogen by hot extraction with a carrier gas.

As the optical spectrum of the tantalum matrix contains a very large number of lines, there are many possibilities for interference; trace element-matrix separation offers the possibility to overcome the problems [122, 124, 125]. For the final determination, ICP-AES, ICP-mass spectrometry, or neutron activation analysis are used. For trace determination in the sub-ppm region, glow discharge mass spectrometry is now the most sensitive routine method of determination [126].

## 29.9 Economic Aspects

Figure 29.2 shows how the price of tantalum has fluctuated over recent years. The most important tantalum processors have made long-term ore contracts with the large mining concerns [127]. World production of tantalum ores (Table 29.1) is well below capacity.

World demand for tantalum has changed little since 1970, remaining at ca. 1000 t/a. Forecasts based on increasing tantalum demand for electrolytic capacitors [128] have not been borne out, as developments in tantalum powders have meant that increasingly less tantalum powder is required for a given capacitor type [129]. However, the number of tantalum capacitors produced has grown continually, from ca.  $2 \times 10^9$  in 1975 to ca.  $9 \times$

$10^9$  in 1992 [53]. The most important area of use is for electrolytic capacitors, which account for > 50% of total world production of tantalum. The use of tantalum carbide as an additive in the hard metal industry, which was still important in 1980, has decreased in recent years [17] as TaC is being replaced by chromium and vanadium carbides for cost reasons. Figure 29.3 illustrates the shifting market shares of the various application areas over recent decades. Applications not included, e.g., Ta<sub>2</sub>O<sub>5</sub> in optical applications and in X-ray phosphors, account for considerably less than 5% of the market.

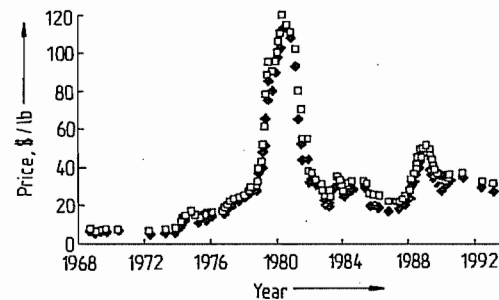

Figure 29.2: Tantalum ore prices. London Metal Bulletin 25/40% Ta<sub>2</sub>O<sub>5</sub>, based on 30% Ta<sub>2</sub>O<sub>5</sub>, cost, insurance, and freight.

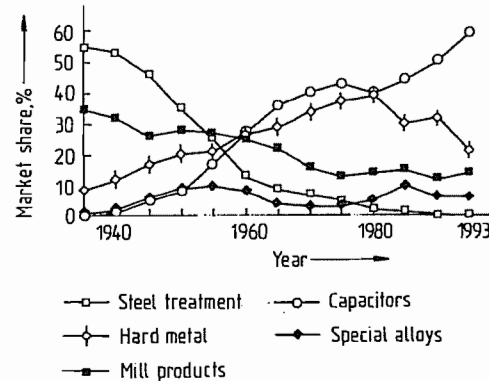

Figure 29.3: Market share of tantalum applications, 1935-1993.

## 29.10 Toxicology

Metallic tantalum is completely nontoxic and bioinert, and allergic reactions are unknown. This has enabled it to be used in X-ray

diagnostics and surgery (Section 29.6.4). Tantalum carbide is not known to have acute toxicity. Tantalum oxide is classified as nontoxic, although animal experiments indicate that the LD<sub>50</sub> (rat, oral) is 8000 mg/kg (RTECS). For respirable dusts of metallic tantalum, the MAK value is 5 mg/m<sup>3</sup>. Tantalum chloride has a strongly corrosive and irritant effect, owing to the hydrolytic production of hydrogen chloride. The LD<sub>50</sub> (rat, oral) is 1900 mg/kg (RTECS). MAK values have not yet been established for tantalum oxide, tantalum carbide, and tantalum chloride. Potassium heptafluorotantalate has toxic properties due to its fluoride content; LD<sub>50</sub> (rat, oral) is 2500 mg/kg (RTECS), and MAK for dusts is 2.5 mg/m<sup>3</sup> total dust (calculated as fluoride) [130].

## 29.11 References

- R. Kieffer, H. Braun: *Vanadin-Niob-Tantal*, Springer Verlag, Berlin-Göttingen-Heidelberg 1963.
- Gmelin, 50, part B1, pp. 1-4.
- S. M. Cardonne, P. Kumar, C. A. Michaluk, H. D. Schwartz, *Adv. Mater. Processes* 1992, no. 9, 16-20.
- R. Kieffer, G. Jangg, P. Etmayer: *Sondermetalle*, Springer Verlag, Berlin-Heidelberg 1971.
- O. Kubaschewski: *Atomic Energy Review, Tantalum: Physico-Chemical Properties of its Compounds and Alloys*, International Atomic Energy Agency, Vienna 1972.
- W. Köck, P. Paschen, *J. Met.* (1989) no. 10, 33-39.
- G. L. Miller: *Tantalum and Niobium*, Butterworths, London 1959, pp. 91-93.
- E. Erben, R. Lesser, *Metall (Berlin)* 15 (1961) 679-686.
- W. W. Albrecht: "Production, Properties and Application of Tantalum, Niobium and Their Compounds", in P. Möller, P. Cerný, F. Saupe (eds.): *Lanthanides, Tantalum and Niobium*, Springer Verlag, Berlin-Heidelberg 1989, pp. 345-358.
- P. Borchers, G. J. Korinek: "Extractive Metallurgy of Tantalum", *AIIME Annu. Meet. 110th* 1981, 97-108.
- TIC Tantalum-Niobium International Study Center Brussels, *Int. J. Refract. Hard Met.* 7 (1988) no. 1, 3-7.
- L. D. Cunningham: *Mineral Industry Surveys, Columbium (Niobium) and Tantalum in 1993*, U.S. Bureau of Mines, Washington 1994.
- R. Gaupp, G. Moteani, P. Möller, *Erzmetall* 36 (1983) 244-251.
- H. C. Starck GmbH & Co. KG, Internal Raw Material Availability Survey, Goslar 1993.
- TIC Tantalum-Niobium International Study Center Brussels, *TIC Bull.* 62-73 (1990-1993).
- T. C. Pool (ed.): *Elements*, Concord Trading Corp., Denver 1992, pp. 12-17.
- The Economics of Tantalum*, 6th ed., Roskill Information Services, London 1986, p. 2.
- C. Bird, *Met. Bull. Monthly* 1993, no. 5, 48-49.
- W. Rockenbauer, *Metall (Berlin)* 35 (1981) 584-585.
- W. Rockenbauer, *Metall (Berlin)* 38 (1984) 156-159.
- J. Bonjer: "Proceedings of the Seminar on Production and Marketing of Associated Heaugg Minerals from South-East Asian Tin Deposit in Ipoh/Malaysia and Phuket/Thailand", in W. Gocht (ed): *Inter-technik* 26 (1985) 179-206.
- Kawecki Berylko Ind., US 3721727, 1971 (R. A. Gustison).
- Metallurgie Hoboken-Overpelt, DE 2844914, 1978 (M. C. F. van Hecke, J. Deweck).
- Hoboken-lez-Anvers, US 2131350, 1937 (J. P. Lee-mans).
- Kawecki Chemical Comp., US 3447894, 1966 (R. A. Gustison, W. Lawn, F. Gorcyca, J. A. Cenerazzo).
- Kawecki Berylko Ind., US 3585024, 1968 (J. A. Cenerazzo, C. E. Mosheim, C. E. Marvasi).
- R. Kieffer, F. Benesovsky: *Hartstoffe*, Springer Verlag, Wien 1963.
- Western Electric Co., US 3697255, 1972 (W. M. Baldwin, E. O. Fuchs, D. J. Sharp, J. H. Swisher).
- H. C. Starck, DE 2133104 C3, 1978 (H. Meyer).
- K. Mimura, T. Takahashi, M. Nanjo, *J. Min. Mater. Proc. Inst. Jpn.* 106 (1990) no. 4, 187-192.
- N. Sato, T. Takenaka, Y. Wei, M. Nanjo, *Tohoku Daigaku Senko Seiren Kenkyusho Iho* 46 (1990) no. 2, 96-104.
- GTE Products Corp., US 4255397, 1981 (B. E. Martin, J. E. Ritsko, H. L. Acla).
- G. P. Power, *Chem. Aust.* 46 (1979) no. 7, 303-307.
- VEB Kombinat Metallaufbereitung, DD 207932, 1984 (G. Beyer, H. Bernhardt, H. Dam, H. K. Kiesling, W. Tomalik, A. Zimmermann).
- NRC Inc., US 2950185, 1960 (E. D. Hellier, G. L. Martin).
- NRC Inc., US 4141720, 1979 (H. Vartanian).
- H. C. Starck, US 3635693, 1969 (H. J. Friedrichs, H. Meyer).
- H. C. Starck, DE 3130392, 1983 (W. W. Albrecht, 33 U. Papp).
- Fansteel, US 4356028, 1982 (V. T. Bates).
- H. C. Starck, DE 3140248, 1983 (W. W. Albrecht, D. Behrens).
- NRC Inc., US 4957541 (T. B. Tripp).
- W. W. Albrecht, D. P. Ingalls: "Hochtemperaturreinigung von Tantal und Niob", in Gesellschaft Deutscher Metallhütten- und Bergleute (eds.): *Raffinationsverfahren in der Metallurgie*, Verlag Chemie, Weinheim 1983, pp. 229-242.
- Gmelin, 50, part A2, pp. 490-491.
- C. A. Hempel: *Rare Metals Handbook*, 2nd ed., Reinhold Publ. Corp., London 1961.
- Fansteel, US 4859257, 1989 (V. T. Bates, C. Po-kross).
- E. Raub, E. Röschel, *Z. Metallkd.* 53 (1962) 93-103.
- G. Jangg, R. Eck, *Metall (Berlin)* 31 (1977) 750.



48. G. D. Corey, *Proc. Int. Symp. Tantalum 1st* 1978, 61–82.
49. F. J. Hunkeler: "Properties of Tantalum for Applications in the Chemical Process Industry", in R. E. Smallwood (ed.): "Refractory Metals and Their Industrial Applications", *ASTM Spec. Tech. Publ.* 849 (1984) 28–49.
50. M. Hörmann, *Metall (Berlin)* 42 (1988) 400–406.
51. U. Draugelates, B. Bouaifi, H. Steinberg, *Werkst. Korros.* 44 (1993) 269–273.
52. R. L. Taylor, H. E. Haring, *J. Electrochem. Soc.* 103 (1956) 611–613.
53. Tantalum–Niobium International Study Center, *TIC Bull.* 73 (1993) 2–3.
54. M. Fernández, J. Baonza, J. M. Albella, J. M. Martínez-Duart, *Electrocomponent Sci. Technol.* 7 (1981) 205–210.
55. Sprague Electric Comp., US 4781802, 1988 (E. J. Fresia).
56. G. P. Klein, N. J. Jaeger, *J. Electrochem. Soc.* 117 (1970) 1483–1494.
57. T. Kudoh, M. Katoh, M. Watase, *Denki Kagaku oyohi Kogyo Butsuri Kagaku* 40 (1972) 701–705.
58. D. M. Smyth, G. A. Shim, T. B. Tripp, *J. Electrochem. Soc.* 110 (1963) 1264–1270.
59. D. M. Smyth, T. B. Tripp, *J. Electrochem. Soc.* 110 (1963) 1271–1276.
60. D. M. Smyth, G. A. Shim, T. B. Tripp, *J. Electrochem. Soc.* 111 (1964) 1331–1336.
61. D. A. Vermilyea, *J. Appl. Phys.* 36 (1965) 3663–3671.
62. D. A. Vermilyea, *J. Electrochem. Soc.* 112 (1965) 1232–1234.
63. M. Burnham, Hughs Aircraft Company Report, no. M 74-08, Culver City, CA, 1974.
64. K. Andersson, H. Naito, T. B. Tripp, *Proc. 6th Europ. Capacitor and Resistor Tech. Symp. CARTS-Europe*, Brugge 1992, pp. 1–6.
65. Tantalum–Niobium International Study Center Brussels, *TIC Bull.* 69 (1992) 6–8.
66. D. B. Plone, *J. Am. Osteopath Assoc.* 73 (1974) no. 4, 635–640.
67. P. J. Friedman, G. M. Tisi, *Radiology (Easton, PA)* 104 (1972) Sept., 523–535.
68. E. Kammler, W. Weller, W. T. Ulmer, E. Bruckmann, *Pneumologie* 146 (1972) 241–249.
69. G. T. Daughters et al., *J. Thorac. Cardiovasc. Surg.* 104 (1992) no. 4, 1084–1091.
70. T. Friden, L. Ryd, A. Lindstrand, *Acta Orthop. Scand.* 63 (1992) no. 1, 80–84.
71. B. Tjornstrand, G. Selvik, N. Eglund, A. Lindstrand: *Arch. Orthop. Trauma Surg.* 99 (1981) no. 2, 73–81.
72. L. Rabenseifner, W. Küßwetter, P. H. Wünsch, M. Schwab, *Z. Orthop.* 122 (1984) 349–355.
73. B. Heinrich et al., *Z. Stromatol.* 75 (1977) no. 6, 214–224.
74. P. Tetsch: *Enossale Implantationen in der Zahnheilkunde*, 2nd ed., Hanser Verlag, München 1991, pp. 46–47.
75. F. Kylvberg, *Acta Chir. Scand.* 141 (1975) no. 3, 242–244.
76. F. Magistris, *Wien. Klin. Wochenschr.* 86 (1974) no. 8, 225–228.
77. F. Magistris, *Chirurg* 46 (1975) no. 11, 518–521.
78. H. Kobayashi et al., *Neurol. Res.* 8 (1986) no. 4, 221–224.
79. S. A. Wexler, B. R. Frueh, D. C. Musch, M. A. Pachtman, *Ophthalmology (Philadelphia)* 92 (1985) no. 5, 671–675.
80. H. J. Gerhardt, G. Muhler, D. Szdzy, F. Biedermann, *Zentralbl. Neurochir.* 40 (1979) no. 1, 85–94.
81. J. Carleone, *TIC Bull.* 71 (1992) 5–10.
82. Central Glass Co., JP 04243935, 1992 (N. Takeuchi, T. Ito, M. Takayama, K. Furuyo, H. Nakajima, H. Iida).
83. F. Izumi, H. Kodama, *J. Less-Common Met.* 63 (1979) 305–307.
84. H. C. Starck, DE 4021207 A1, 1990 (W. Bludbus, J. Eckert).
85. T. Ichimura: "Niobiumoxide in Optical Glass Manufacture", in H. Stuart (ed.): *Niobium Proc. Int. Symp.* 1984, 603–614.
86. Mitsubishi Chem. Ind., JP 63051945, 1986 (H. Wada, T. Ushikubo).
87. Bayer, DE 4133675, 1991 (O. Immel, H. J. Buysch, G. Darsow).
88. Bayer, EP 433811, 1991 (O. Immel, H. Waldmann, R. Braden).
89. Mitsubishi Kasei Corp., JP 01050843, 1989 (H. Wada, T. Ushikubo).
90. Mitsubishi Kasei Corp., JP 63225329, 1988 (T. Maki, T. Yokoyama, Y. Sumino).
91. H. J. Lunk, S. Schönherr, *Z. Chem.* 27 (1987) 157–170.
92. B. C. Grabmaier, F. Otto, *J. Cryst. Growth* 79 (1986) 682–688.
93. S. Miyazawa, H. Iwasuki, *J. Cryst. Growth* 10 (1971) 276–278.
94. S. Miyazawa, H. Iwasuki, *Rev. Electr. Commun. Lab.* 21 (1973) 374–383.
95. AGFA-Gévaert, EP 0520094 A1, 1992 (D. Philip).
96. O. Renoult, J. B. Boilot, F. Chaput, *J. Am. Ceram. Soc.* 75 (1992) 3337–3340.
97. S. Kawashima, M. Nishida, I. Ueda, H. Ouchi, *J. Am. Ceram. Soc.* 66 (1983) 421–423.
98. D. A. Sagala, S. Nambu, *J. Am. Ceram. Soc.* 75 (1992) 2573–2575.
99. K. Tochi, *J. Am. Ceram. Soc. Jpn. Int. Ed.* 100 (1992) 1441–1442.
100. J. K. Gibson, *J. Fluorine Chem.* 55 (1991) no. 3, 299–311.
101. A. I. Papov, V. F. Sukhoverkov, N. A. Chumaevskii, *Zh. Neorg. Khim.* 35 (1990) 1111–1122.
102. E. I. Du Pont de Nemours, WO 92/03382, 1990 (M. Nappa).
103. Asahi Glass Co., WO 9008754 A2 090809, 1990 (S. Morikawa, S. Samejima, H. Okamoto, K. Ohnishi, S. Tatematsu, T. Tanuma, T. Ohmori).
104. Ciba, DE 1066194, 1957 (W. Scheller).
105. Ciba, DE 1056105, 1956 (F. Kern, W. Schornsein).
106. D. C. Bradley, B. N. Chakravarti, W. Wardlaw, *J. Chem. Soc.* 52 (1956) 2381–2384.
107. R. Gut, *Helv. Chim. Acta* 47 (1964) 2262–2278.
108. N. Sato, M. Nanjo, *High Temp. Mater. Proc.* 8 (1988) 39–46.
109. M. A. Nicolet, *Thin Solid Films* 52 (1978) 415–443.
110. J. R. Shappirio, *Solid State Technol.* 28 (1985) 161–166.
111. E. Jiang, C. Sun, J. Li, Y. Liu, *J. Appl. Phys.* 65 (1989) 1659–1663.
112. K. I. Portnoi, V. M. Romashov, *Sov. Powder Metall. Met. Ceram. (Engl. Transl.)* 11 (1972) 378–384.
113. S. P. Murarba, D. B. Fraser, W. S. Lindenberger, A. K. Sinha, *J. Appl. Phys.* 51 (1980) 3241–3245.
114. K. Hieber, F. Neppel, *Thin Solid Films* 140 (1986) 131–135.
115. R. Fresenius, G. Jander: *Handbuch der analytischen Chemie*, Part 3, "Quantitative Bestimmungs- und Trennungsmethoden", vol. 5b, "Elemente der 5. Gruppe, Vanadin, Niob, Tantal", Springer Verlag, Berlin 1957.
116. R. W. Moshier: *Analytical Chemistry of Niobium and Tantalum*, Pergamon Press, New York 1964.
117. J. M. Gibalo: *Analytical Chemistry of Niobium and Tantalum*, Ann Arbor, London 1970.
118. O. G. Koch, G. A. Koch-Dedic: *Handbuch der Spurenanalyse*, Part 2, 2nd ed., Springer Verlag, Berlin–Heidelberg–New York 1974.
119. S. Kallmann, H. Obertin, R. Liu, *Anal. Chem.* 34 (1962) 609–613.
120. A. H. Knight, *TIC Bull.* 45 (1964) 7–8.
121. Autorenkollektiv: *Methoden zur Bestimmung von Spurenanalyse in Niob, Tantal und Wolfram*, VEB Deutscher Verlag für Grundstoffindustrie, Leipzig 1970.
122. J. Stummeyer, G. Wünsch, *Fresenius J. Anal. Chem.* 342 (1992) 203–206.
123. O. Hilmer, J. Peters, A. Breustedt, A. Hoppe: "Bestimmung des Phosphors in Refraktärmetallen und deren Verbindungen", in D. Hirschfeld (ed.): *Nichtmetalle in Metallen '90*, Deutsche Gesellschaft für Metallkunde (oGM), Oberursel 1990, pp. 85–92.
124. V. Krivan et al., *Fresenius J. Anal. Chem.* 341 (1991) 550–554.
125. R. Caletka, R. Hausbeck, V. Krivan, *J. Radioanal. Nucl. Chem.* 120 (1988) no. 2, 319–333.
126. N. Jakubowski, D. Stuewer, G. Tölg, *Int. J. Mass Spectrom. Ion Processes* 71 (1986) 183–197.
127. *Met. Week* 5 (1991) 21.
128. W. Gocht: *Handbuch der Metallmärkte*, 2nd ed., Springer Verlag, Berlin–Heidelberg–New York–Tokyo 1991, pp. 401–413.
129. I. Salisbury, *Proc. 5th Europ. Capacitor and Resistor Tech. Symp. CARTS-Europe*, Munich 1991, pp. 81–88.
130. H. C. Starck GmbH u. Co. KG, Sicherheitsdatenblätter für Tantal-Metall, Tantalcarbid, Tantaloxid, Tantalpentoxid, Tantalchlorid und Kaliumtantalfluorid, Goslar 1994 (in press).

## 30 Zirconium

RALPH H. NIELSEN

30.1 Introduction .....	1431	30.10.4 Bromides .....	1449
30.2 Properties .....	1432	30.10.5 Iodides .....	1449
30.3 Occurrence, Ores, and Mining .....	1434	30.10.6 Fluorides .....	1449
30.4 Production .....	1435	30.10.7 Sulfates .....	1450
30.4.1 Opening-up of Ore .....	1435	30.10.8 Carbonates .....	1450
30.4.2 Hafnium Separation .....	1437	30.10.9 Hydride .....	1450
30.4.3 Reduction to Metal .....	1439	30.10.10 Carbide .....	1451
30.4.4 Refining .....	1440	30.10.11 Nitrides .....	1451
30.5 Fabrication .....	1440	30.10.12 Borides and Borates .....	1452
30.6 Hazards in Handling Zirconium Metal .....	1442	30.10.13 Tungstate .....	1452
30.7 Grades and Specifications .....	1443	30.10.14 Phosphate .....	1452
30.8 Uses .....	1444	30.10.15 Nitrates .....	1453
30.9 Economic Aspects .....	1444	30.10.16 Carboxylates .....	1453
30.10 Compounds .....	1445	30.10.17 Alkoxides .....	1453
30.10.1 Silicate .....	1445	30.11 Analysis .....	1453
30.10.2 Oxides .....	1446	30.12 Toxicology .....	1454
30.10.3 Chlorides and Hydroxide Chlorides .....	1447	30.13 Storage and Transportation .....	1455
		30.14 References .....	1455

### 30.1 Introduction

On analyzing the gem mineral known as jargon from Sri Lanka, KLAPROTH in 1789 found it contained an oxide which he could not identify and which he later called "zirconerde". In 1824 BERZELIUS prepared the first zirconium metal, an impure black powder, by heating potassium hexafluorozirconate and potassium in a closed pot. LELY and HAMBURGER prepared the first relatively pure zirconium in 1904 by reduction of zirconium tetrachloride with sodium in a bomb, producing malleable, corrosion-resistant zirconium pellets. But it was a hundred years after BERZELIUS before VAN ARKEL, DE BOER, and FAST [1, 2] developed the iodide process which produced the first massive zirconium metal that could be cold worked and which exhibited good ductility at room temperature.

Early uses for zirconium metal were in pyrophoric devices such as fuses, ammunition primers, fireworks, photoflash powder, and flares. Zirconium powder was used exten-

sively as a gettering material in vacuum tubes. By 1946 the consumption of zirconium for these purposes was about 5 t/a. Less than 50 kg of ductile iodide metal was sold, at ca. \$700 per kilogram.

W. J. KROLL carried out the first inert-atmosphere magnesium reduction of zirconium tetrachloride in his Luxembourg laboratory in 1938 [3]. In 1944 the U.S. Bureau of Mines started a project to make ductile zirconium economically. KROLL was assigned to take over direction of the project in January, 1945. By 1947, a pilot plant was producing 30 kg of zirconium sponge per week. Concurrently, researchers at Massachusetts Institute of Technology and at Oak Ridge National Laboratory were evaluating the physical and atomic properties of metals as potential uranium fuel cladding materials for nuclear power stations. In 1948 hafnium-free zirconium was selected as most promising. By 1949 zirconium had been chosen as the structural material for the fuel core of the submarine thermal reactor, the land-based reactor prototype, and during

1949–1950 a satisfactory hafnium separation process was developed at Oak Ridge. By the end of 1950, 3000 kg of hafnium-free zirconium metal strip had been produced, and the zirconium metal producing industry was launched as an integral part of the beginning nuclear power industry.

## 30.2 Properties

**Physical Properties.** Zirconium is a lustrous, strong, ductile metal similar in appearance to stainless steel. Pure zirconium metal has three solid phases:  $\omega$ -Zr, which is stable below 200 K at ambient pressure and up to 1000 K at 6 GPa [4];  $\alpha$ -Zr, which is stable from 200 K to 1125 K; and  $\beta$ -Zr, which is the stable form between 1125 K and the melting point. These transition temperatures change with the addition of  $\alpha$ - or  $\beta$ -stabilizing alloying elements. The important physical properties are presented in the following:

Relative atomic mass	91.224
Atomic radius	15.90 nm (in metal lattice)
Ionic radius (Zr <sup>4+</sup> )	7.5 nm
Electronegativity	1.22
Standard potential M/MO <sub>2</sub>	1.53 V
Melting point	1852 ± 2 °C
Boiling point	3850 °C
Crystal structure of $\omega$ -Zr	hexagonal open
$\alpha$ -Zr	hexagonal dense, $a = 32.3$ nm, $c = 51.5$ nm
$\beta$ -Zr	body-centered cubic, $a = 36.1$ nm
Transformation temperatures	
$\omega \rightarrow \alpha$	-73 °C
$\alpha \rightarrow \beta$	862 ± 5 °C
Heat of fusion	2.30 × 10 <sup>4</sup> J/mol
Heat of evaporation	5.96 × 10 <sup>5</sup> J/mol
Electrical resistivity	3.89 × 10 <sup>-5</sup> Ωcm
Thermal conductivity at 25 °C	21.1 Wm <sup>-1</sup> K <sup>-1</sup>
at 100 °C	20.4
at 300 °C	18.7
Specific heat at 25 °C	0.285 Jg <sup>-1</sup> kg <sup>-1</sup>
at 865 °C	0.335
Thermal expansion coefficient	
$\alpha$ , bulk, at 25 °C	5.89 × 10 <sup>-6</sup> K <sup>-1</sup>
$\alpha$ -Zr,    $c$ axis	6.4 × 10 <sup>-6</sup>
$\alpha$ -Zr, ⊥ $c$ axis	5.6 × 10 <sup>-6</sup>
$\beta$ -Zr	9.7 × 10 <sup>-6</sup>
Density of $\alpha$ -Zr	6.50 g/cm <sup>3</sup>
$\beta$ -Zr	6.05
Effective cross section for thermal neutrons	1.9 × 10 <sup>-29</sup> m <sup>2</sup> (0.19 barns)

**Mechanical Properties.** Although zirconium is a high-melting metal, its mechanical proper-

ties are similar to those of much lower melting metals: its elastic modulus is quite low, and its strength diminishes rapidly with increasing temperature. The mechanical properties of zirconium are strongly dependent on purity, especially the oxygen and nitrogen content, the amount of cold work, and the crystallographic texture. Forged or rolled zirconium shows marked anisotropy in mechanical properties in both the as-formed and annealed conditions. Pure zirconium is ductile at liquid-nitrogen temperatures but the metal is subject to hydrogen embrittlement whenever the hydrogen content sufficiently exceeds the hydrogen solubility at the operating temperature. Tables 30.1 and 30.2 gives typical values of the more important mechanical properties of zirconium and of Zircaloy 2 and Zircaloy 4 (see also Section 30.9).

Table 30.1: Mechanical properties of zirconium.

Property	20 °C	200 °C	300 °C
Tensile strength, MPa	300–450	200–250	150–180
Elastic limit 90.2%, MPa	200–300	110–130	75–85
Elongation, %	25–35	50–60	45–55
Modulus of elasticity, MPa	7.5 × 10 <sup>4</sup>	8.3 × 10 <sup>4</sup>	7.2 × 10 <sup>4</sup>
Brinell hardness	90–130		
Shear modulus	36 500		
Poisson's ratio	0.35		

**Chemical Properties.** Zirconium is a very reactive metal that, in air or aqueous solution, immediately develops a surface oxide film. This stable, adherent film is the basis for zirconium's corrosion resistance. In most media, zirconium is more resistant than titanium or stainless steel. Its acid resistance approaches that of tantalum, but unlike tantalum, zirconium is also resistant to caustic media.

Fluoride ions bond strongly to zirconium, and even a trace of fluoride in most media will drastically reduce its corrosion resistance.

The corrosion resistance in sulfuric acid is excellent at temperatures up to 150 °C and acid concentrations up to 70%, except that welds and adjacent heat-affected zones are susceptible to corrosive attack above 60% concentration. This can be alleviated by annealing.

Table 30.2: Mechanical properties of Zircaloy 2 and Zircaloy 4.

Property	Annealed			Recrystallized		
	20 °C	200 °C	400 °C	20 °C	200 °C	400 °C
Tensile strength, MPa	785	440	380	520	290	190
0.2% yield strength, MPa	600	360	300	370	150	130
Ultimate elongation (50 mm), %	17	20	20	34	45	55

Ferric, cupric, and nitrate ion impurities in sulfuric acid decrease the corrosion resistance at acid concentrations above 65%. Even at room temperature zirconium is rapidly attacked at concentrations above 75%.

The corrosion resistance in hydrochloric acid is excellent at temperatures up to 130 °C and concentrations up to 37%. However, even small amounts of ferric or cupric ions will lead to severe pitting and stress cracking.

The corrosion resistance in nitric acid is excellent at all concentrations up to 90% and temperatures up to 200 °C. In concentrations above 65%, stress corrosion cracking may occur if high tensile stresses are present [5].

The corrosion resistance in phosphoric acid is excellent in all concentrations up to 65 °C, and, at concentrations below 40%, up to 185 °C.

Zirconium is rapidly attacked by hydrofluoric acid, even at concentrations below 0.1%.

The corrosion resistance in sodium hydroxide and potassium hydroxide is excellent at all concentrations, up to the boiling temperature. Zirconium is resistant to molten sodium hydroxide up to 1000 °C.

Zirconium is very resistant to most organic compounds at all concentrations and temperatures. But, when air or moisture are not available to reform the surface oxide film, zirconium is attacked by anhydrous chlorinated organics at elevated temperatures and is etched by bromine or iodine dissolved in anhydrous organics. Stress corrosion cracking may also occur.

Zirconium reacts with most gases at relatively low temperatures.

Zirconium forms a visible interference color film in air starting above 200 °C. Above 400 °C the adherent oxide film is black.

Above 540 °C a loose gray-white oxide forms, the oxide layer becomes thicker as oxygen diffuses into the underlying metal, and the metal can become embrittled after prolonged exposure. The maximum continuous operating temperature of zirconium in air is ca. 450 °C. Short-term hot working such as forging, rolling, and extrusion are conducted at 550–1000 °C. Afterwards, the surface oxide and embrittled metal layer are mechanically and chemically removed. While solid zirconium metal is oxidized slowly in air, the oxidation is exothermic, and for high-surface-area forms, such as powder or sponge metal, the large heat release may cause ignition.

Oxygen-containing gases, such as carbon dioxide, carbon monoxide, sulfur dioxide, steam, and nitrogen oxides, oxidize zirconium somewhat slower than air. The maximum continuous operating temperature is about 400 °C.

Zirconium reacts more slowly with nitrogen than with oxygen because the reaction is less exothermic.

Zirconium readily absorbs hydrogen above 300 °C. The rate of absorption varies inversely with the thickness of the surface oxide film. Hydrogen solubility increases with temperature. On cooling, when the solubility is exceeded, zirconium hydride platelets precipitate, embrittling the metal. The reaction is reversible: hydrogen is removed on heating the metal above 600 °C in a high vacuum.

Zirconium's oxide film protects it from dry chlorine gas at room temperature, but any impact or abrasion that exposes a fresh metal surface may initiate an exothermic reaction producing zirconium tetrachloride vapor.

More information on the chemical behavior of zirconium metal can be found in [6].

### 30.3 Occurrence, Ores, and Mining

Zirconium is the ninth most abundant metal in the earth's crust, with an estimated concentration of 0.016–0.025% [7], about one twentieth that of titanium but more plentiful than nickel, copper, or zinc. Zirconium occurs only in fully oxidized form, never as free metal.

There are over 40 known zirconium minerals which can be grouped:

- Zirconium orthosilicates: Zircon and its metamict varieties
- Zirconium dioxide: baddeleyite and its altered varieties
- Zirconosilicates with sodium, calcium, iron, and other elements: eudialyte, eucolite, gittinsite and others
- Zirconium carbonates with sodium, calcium, and other elements: weloganite and others
- Others, including zirconolite ( $\text{CaZrTi}_2\text{O}_7$ )

Zircon is the predominant commercial zirconium mineral, but the minerals baddeleyite and eudialyte are also being used. All are obtained as by-products of other mineral recovery operations.

**Zircon**,  $\text{ZrSiO}_4$ , occurs as an accessory mineral in silica-rich igneous rocks, particularly granite, nepheline syenite, and pegmatite, and also in metamorphic and sedimentary rocks. Zircon is rarely found in rocks in economically minable concentration. Weathering and erosion of these rocks frees the zircon grains, and the combined action of rivers, seas, and wind concentrate the heavier minerals by natural gravitation processes in placer deposits, deltas, and ocean beaches. As an ore, zircon is recovered from unconsolidated sands in beach deposits.

Large heavy mineral sands deposits are being extensively mined in Florida, West Australia, South Africa, India, Russia and Kazakhstan, with smaller operations in Sierra Leone, Sri Lanka, Madagascar, Malaysia, Brazil, Indonesia, Thailand, Ukraine and, Vietnam. In Canada, some zircon is obtained from

the processing of Athabasca tar sands. Undeveloped heavy mineral beach sand reserves containing zircon exist in New Jersey, the Carolinas, Georgia, Tennessee, Colorado, New Mexico, Oregon, Utah, Wyoming, Egypt, Malawi, Senegal, and Tanzania.

These heavy mineral sands deposits are mined to obtain the titanium minerals rutile, leucocoxene, and ilmenite to supply the titanium metal and titanium oxide pigment industries. Depending on the deposit's composition and current market pricing, zircon and other minerals are viable by-products. Australia and South Africa are major zircon exporters.

Mining of heavy mineral sands involves first removing a light sand overburden, followed by removal of the heavy sands layers using elevating scrapers and bulldozers, or by flooding the excavation and using dredges in the pond. The heavy minerals are concentrated by gravity separation, and the quartz, light minerals, fines, clay, and silt are returned to the back end of the excavation. Since the heavy mineral sands are only 4–7% of the deposit, the site can be rehabilitated close to the original elevation, topsoil replaced, and native vegetation replanted. The concentrate is hauled to a ore-dressing site where the grains may be scrubbed to remove surface coatings, dried, and separated into individual mineral components: rutile, leucocoxene, ilmenite, zircon, xenotime, monazite, staurolite, garnet, kyanite, and sillimanite. These separation steps utilize differences in the specific gravity, induced magnetism, and electrical conductivity of the individual minerals grains to gradually recover each mineral in good purity.

The various mining operations produce a range of zircon products from high grades with very low levels of impurities to lower grades where the impurities vary with the nature of the orebody and the type of separation process used. These various grades supply a range of applications: foundry sands, refractories, abrasives, opacifiers, zirconium chemicals, zirconium metal, and welding rod coatings. A typical analysis of zircon for the metal industry is 66.6%  $(\text{Zr} + \text{Hf})\text{O}_2$ , 0.2%

$\text{Al}_2\text{O}_3$ , 0.15%  $\text{TiO}_2$ , 0.1%  $\text{Fe}_2\text{O}_3$ , 0.1%  $\text{P}_2\text{O}_5$ , 0.025% U, 0.020% Th.

**Baddeleyite**,  $\text{ZrO}_2$ , has been found in Brazil, South Africa, Sri Lanka, and Russia. Brazilian baddeleyite often occurs mixed with zircon. The mixture is known as caldasite and usually contains 65–80% zirconium oxide. South African baddeleyite is a by-product of mining a volcanic orebody for copper and phosphate fertilizer. The baddeleyite concentrate contains 96% zirconium oxide. Russian baddeleyite from the Kola Peninsula is a by-product of open pit iron ore mining.

**Eudialyte**,  $(\text{Ca}, \text{Na}_2)_6(\text{Zr}, \text{Fe})(\text{Si}_3\text{O}_9)_2(\text{OH}, \text{Cl})_2$  has been found in Greenland, Norway, Brazil, Australia, Transvaal, and New Mexico. Some eudialytes contain 12–15% zirconium oxide, yttrium, and small amounts of niobium and rare earth metals.

**Hafnium Content.** All known zirconium minerals contain hafnium, usually in the range of 1.5–2.5%  $\text{Hf}/\text{Zr} + \text{Hf}$ , although higher hafnium contents have been found. There is a tendency for higher-hafnium ores to be also higher in uranium and thorium content. Hafnon, hafnium orthosilicate, with > 95%  $\text{Hf}/\text{Zr} + \text{Hf}$  was found associated with a tantalum ore in Mozambique.

### 30.4 Production

Processing steps for the production of zirconium metal from zircon sand are shown in Figure 30.1.

#### 30.4.1 Opening-up of Ore

Zircon is a refractory mineral whose decomposition requires the use of high temperature and aggressive chemicals. Selection of a particular procedure depends on the subsequent product use or processing.

**Caustic Fusion.** Caustic fusion of zircon with a slight excess of sodium hydroxide at 650 °C (or sodium carbonate at 1000 °C) is the usual zircon decomposition process [8, 9]:

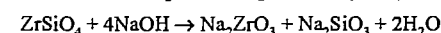

The cooled reaction mass is crushed and slurried in water. Water dissolves the sodium silicate and hydrolyzes the sodium zirconate to soluble sodium hydroxide and insoluble hydrous zirconia. The hydrous zirconia, recovered by filtration, can be fired to oxide, dissolved in mineral acid for further conversion to aqueous zirconium compounds, or dissolved in mineral acid for feeding to a hafnium extraction process.

A variant of the caustic fusion process uses less caustic to produce an acid-soluble sodium zirconium silicate

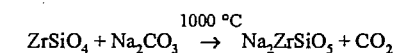

The frit from this reaction is added to strong acid to yield a solution containing sodium and zirconium salts and silica gel:

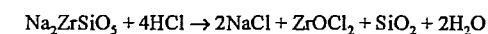

**Chlorination.** Fluidized-bed carbochlorination of milled zircon sand is the zircon decomposition process used by American and French zirconium metal producers. Chlorine is the fluidizing gas. The reaction is endothermic and supplemental energy is supplied, usually by induction heating of the interior graphite wall of the chlorinator.

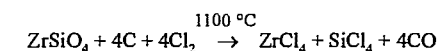

The product gases are cooled to 200 °C in a primary condenser that collects zirconium (and hafnium) tetrachloride as a powder. The remaining gas mixture is cooled to –20 °C in a secondary condenser, collecting silicon tetrachloride as a liquid which is subsequently purified and used to make fumed silica, fused quartz, and fused-quartz optical fiber.

**Thermal Dissociation.** Thermal dissociation of zircon in an arc plasma forms zirconium oxide in droplets of liquid silica. Rapid quenching, to minimize recombination, produces intimately mixed crystals of zirconium oxide in a bead of amorphous silicon oxide [10].

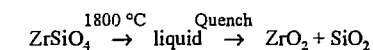

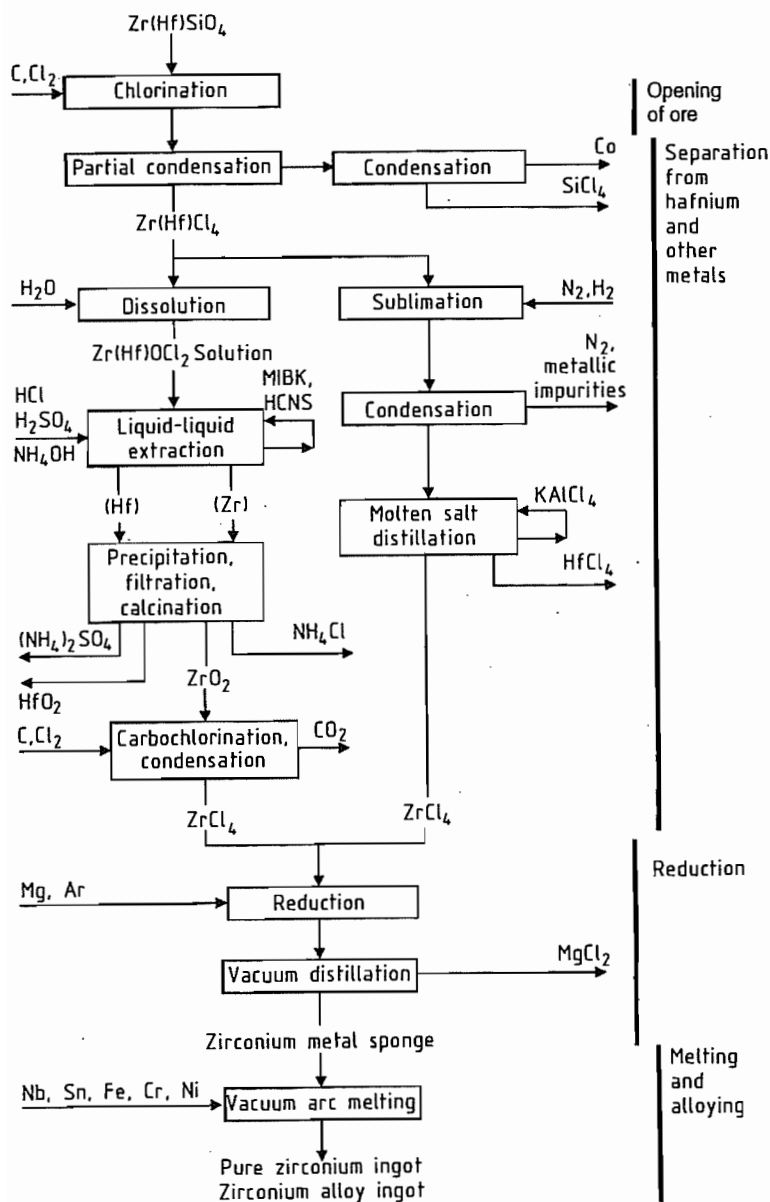
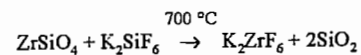

Figure 30.1: Flow diagram for production of zirconium.

The mixture can be leached with sulfuric acid to yield a zirconium sulfate solution and insoluble silica, or leached with sodium hydroxide to yield a sodium silicate solution and insoluble zirconium oxide.

**Fluorosilicate Fusion.** The fusion of zircon and potassium hexafluorosilicate produces potassium hexafluorozirconate [11].



The fused mass is crushed, then the fluoride salt is dissolved with acidified hot water. The hot solution is filtered to remove silica and cooled to crystallize potassium hexafluorozirconate.

**Lime Fusion.** Fusion of zircon with limestone or dolomite produces calcium zirconate and calcium or magnesium silicate:

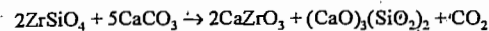

On cooling, the fused mass disintegrates into a very fine calcium silicate powder and coarse calcium zirconate crystals, which can be recovered by mechanical means. The acid-soluble calcium zirconate can be converted into zirconium salts or zirconium oxide.

**Carbiding.** An intimate mix of zircon sand and coke is continually fed into an open-top electric arc furnace. Insufficient carbon is used for complete conversion to carbide, so that silicon monoxide is vaporized at the arc temperature [12]:

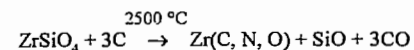

A crude zirconium carbonitride ingot grows under the electrode, surrounded by unreacted mix, which acts as insulation for the steel furnace shell. When the furnace is full, it is moved to a cooling location. When cool, the ingot is separated from unreacted charge, which is recycled. The product is a dense block, having a silver to golden-yellow fracture surface, depending on nitrogen content. The block is broken and crushed to -75 mm chunks, which are subsequently chlorinated to zirconium tetrachloride. If the hot ingot is immediately removed from the furnace shell and unreacted charge, the ingot is oxidized to zirconium oxide containing ca. 5% silica.

**High-Temperature Fusion.** Direct electric arc smelting of baddeleyite or zircon is used to make fused zirconia or fused alumina-zirconia-silica (AZS). The silica is partially vaporized and recovered as fumed silica.

Baddeleyite is converted to zirconium sulfate by direct dissolution in concentrated sulfuric acid at ca. 200 °C. The recovery is low.

Better recoveries are obtained by first heating the baddeleyite with lime to yield calcium zirconate, which reacts with sulfuric acid to give zirconium sulfate and gypsum.

### 30.4.2 Hafnium Separation

Zirconium and hafnium are very similar chemically and metallurgically, and for most uses of zirconium their separation is unnecessary. Their separation is conducted only to produce hafnium-free zirconium metal for the nuclear power industry. Of the many methods developed since the discovery of hafnium, four are used industrially: fluoride salt crystallization, methyl isobutyl ketone extraction, tributyl phosphate extraction, and extractive distillation, in order of their development. In addition, ion exchange has been used for low-throughput, low-investment operations.

**Fluoride Salt Crystallization.** The first separation of zirconium and hafnium by repeated crystallization of potassium hexafluorozirconate from hot aqueous solution is credited to VON HEVESY [13]. The solution is acidified to minimize oxide-fluoride salt formation. At each step the salt crystals are depleted in hafnium. This multistep recrystallization procedure has been used for many years in Ukraine [14].

**Methyl isobutyl ketone extraction** developed at Oak Ridge National Laboratory and used by both American producers, is based on the preferred extraction of a hafnium dihydroxide thiocyanate complex from hydrochloric acid solution by methyl isobutyl ketone [15].

Zirconium-hafnium tetrachloride, produced by carbochlorination of zircon, is dissolved in water, with hydrolysis to form zirconium-hafnium dihydroxide chloride in a hydrochloric acid solution. This solution is contacted with methyl isobutyl ketone to extract iron as  $\text{HFeCl}_4$  into the organic solvent. Then ammonium thiocyanate is added to the dihydroxide chloride solution, providing a mixed dihydroxide chloride/dihydroxide thiocyanate solution of zirconium and hafnium.

This solution is countercurrently contacted with a methyl isobutyl ketone/thiocyanic acid solution to preferentially extract hafnium dihydroxide thiocyanate into the organic phase. This is conducted in a series of mixer-settlers or a series of packed or internally agitated columns. Hafnium is recovered from the ketone solution by scrubbing with dilute sulfuric acid.

Zirconium is recovered from the hydrochloric acid solution by heating the solution above 90 °C, adding precisely two moles of sulfuric acid to each five moles of zirconium, and then carefully raising the pH to 1.2–1.5 with dilute ammonium hydroxide. This precipitates a granular zirconium basic sulfate,  $Zr_5O_8(SO_4)_2 \cdot xH_2O$  which is easily filtered and washed to remove aluminum and uranium impurities. The sulfate filter cake is repulped with dilute ammonium hydroxide to convert it to zirconium hydrous oxide, which is fired to give pure zirconium oxide [16].

In this extraction process, methyl isobutyl ketone and thiocyanate are recovered and reused, but considerable quantities of hydrochloric acid, sulfuric acid, and ammonia are consumed. Zirconium produced typically contains 35–90 mg Hf/kg and the hafnium contains 200–2000 mg Zr/kg, but any degree of separation can be attained, without further chemical consumption, by providing fewer or more contacting stages during separation.

The zirconium oxide and hafnium oxide are each chlorinated in fluidized beds to give their tetrachlorides. Chlorination of the oxides is faster than that of the silicates, and can be efficiently conducted at a lower temperature.

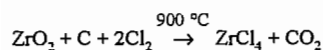

The zirconium tetrachloride is then purified by sublimation at 350–400 °C in a nitrogen atmosphere containing 1–5% hydrogen. The hot gases pass through a filter to remove entrained particles before being cooled to condense the zirconium tetrachloride. This sublimation reduces the levels of oxide, iron, phosphorus, and aluminum.

**Tributyl phosphate extraction**, developed concurrently in Britain, France, and the United

States, was used commercially in the United States and is being used in India to obtain zirconium for the nuclear industry [17]. Hydrous zirconium–hafnium oxide from caustic fusion of zircon is dissolved in nitric acid. The nitric acid solution is countercurrently contacted with an organic solution of tributyl phosphate in kerosine. A zirconium tributyl phosphate complex is preferentially extracted into the kerosine, leaving hafnium and most metallic impurities in the aqueous phase. The zirconium is stripped from the kerosine solution with dilute sulfuric acid solution, precipitated, and fired to pure zirconium oxide.

**Chloride Distillation.** Hafnium tetrachloride is slightly more volatile than zirconium tetrachloride, and separation by fractional distillation would be feasible if the tetrachlorides could be handled as liquids. However, the tetrachlorides are either solid or gaseous, depending on temperature, unless kept, under pressure while being heated to the triple point of zirconium tetrachloride (435 °C, 2.0 MPa). However a distillation process was developed in which the liquid phase was molten potassium chloroaluminate, in which zirconium and hafnium tetrachloride are soluble without forming compounds that could impede the separation or the recovery of separated chloride [18].

The zirconium–hafnium tetrachloride from chlorination of zircon is first purified by sublimation. The purified tetrachloride is revaporized and the vapor is introduced into the distillation column, above the midpoint. The potassium chloroaluminate liquid, equilibrated with hafnium-rich tetrachloride, is fed into the top tray of the distillation column, which is at 350 °C. As the liquid cascades down the column, it is gradually stripped of the more volatile hafnium tetrachloride while acquiring zirconium tetrachloride from the rising vapor. The zirconium tetrachloride in the liquid melt reaching the bottom of the column contains < 50 mg Hf/kg Zr.

In the boiler at the column bottom some of the zirconium tetrachloride is vaporized to provide the rising vapor in the column. From

the boiler the liquid melt goes to a short, hotter column where it is stripped with nitrogen to remove the product zirconium tetrachloride.

The stripped liquid melt is returned to an absorber–condenser above the distillation column where it is equilibrated with hafnium-rich tetrachloride vapor, then returned to the top of the distillation column. Unabsorbed hafnium-rich tetrachloride vapor (HfCl<sub>4</sub> content 30–50%) is led to a condenser. The hafnium-rich tetrachloride is accumulated until it can be reprocessed in the distillation column in a separate campaign to recover pure hafnium tetrachloride (< 1% ZrCl<sub>4</sub>).

Control of the potassium to aluminum ratio in the melt is crucial. Excess potassium chloride preferentially bonds with hafnium tetrachloride, reducing its effective vapor pressure and thereby decreasing the separation efficiency. With a deficiency of potassium chloride, aluminum chloride is lost into the nitrogen stream in the stripper, contaminating the zirconium tetrachloride product.

This distillation process has a higher yield than the liquid–liquid extraction processes, does not consume large quantities of chemicals, and eliminates the rechlorination step. It is very capital intensive.

**Other Processes.** Although zirconium is not easily reduced except by very strong reducing agents, it can be reduced more easily than hafnium. This has led to several separation procedures. The most significant [19] involved both molten metal (zinc base) and molten halide salts for good contact between the phases and for the close approach to equilibrium needed for good separation factors.

### 30.4.3 Reduction to Metal

Oxygen toughens zirconium metal, decreasing its ductility and therefore its formability as a metal. To produce ductile zirconium metal, the zirconium compound to be reduced and the reducing agent should be as free of oxygen (and nitrogen and carbon) as possible. Anhydrous zirconium tetrachloride or tetrafluoride are usually used.

**Kroll Process.** Ductile zirconium metal is produced by reduction of pure zirconium tetrachloride with molten magnesium under an inert gas (helium or argon). The reduction retort is a long, vertical cylinder composed of two sections. The lower third is a stainless-steel-lined crucible which holds the magnesium ingots. The upper two-thirds has a central annular pipe slightly shorter than the retort wall. The space between the wall and the central pipe is filled with zirconium tetrachloride powder, then the two sections are welded together and a lid is bolted to the top. The assembled retort is warmed to 200 °C, evacuated and filled with argon several times to remove the last traces of air. The retort is lowered into a furnace with heating zones for each retort section. The lower section is then heated to 850 °C to melt the magnesium, and argon is bled from the warming retort to maintain atmospheric pressure (the retort is not a pressure vessel). Zirconium tetrachloride vapor passes down through the central pipe, which communicates with the lower section, and is reduced by the molten magnesium. At the end of the reduction, the lower crucible contains a thick suspension, or mud, of tiny zirconium metal beads in liquid magnesium, under a layer of liquid magnesium chloride. The retort is cooled and unloaded. The stainless steel liner is separated from the reduction mass and the layer of magnesium chloride is mechanically removed from the zirconium–magnesium metallic regulus. Several reduction reguli are stacked and loaded into a distillation furnace for removal of magnesium and residual magnesium chloride. The distillation is conducted in a vacuum (< 1 Pa), with the charge located in the upper end of the retort. The bell furnace around the top of the retort is heated in programmed steps, reaching 980 °C in ca. 30 h. As the charge heats, the magnesium chloride melts and drains away, and the magnesium metal slowly evaporates, condensing on the water-cooled retort wall. As the magnesium evaporates, the zirconium beads come into closer contact and begin to sinter together. The final sintered porous mass is known as zirconium sponge. The heating schedule is critical:

If the magnesium receives heat faster than heat is removed by magnesium transpiration at the surface of the reguli, the reguli become soft and flow down out of the heated zone. After the retort is cooled and the sponge conditioned by slow, controlled exposure to air, the sponge regulus is removed from the retort. The regulus is broken into chunks by using a hydraulic chisel. The chunks are sorted into quality grades depending on color and relative location in the regulus. The chunks are crushed to less than 2 cm, and screened to remove -20 mesh fines, which are higher in impurities.

**Other Reduction Processes.** Ductile zirconium has been produced commercially in a two-step sodium reduction analogous to a titanium reduction process [20]. Zirconium tetrachloride vapor and liquid sodium are both slowly fed into an argon-filled stirred reactor containing granular sodium chloride to obtain a  $ZrCl_2$ -NaCl mixture. This first step is very exothermic and the feed rate is controlled to allow excess heat to escape. The mixture is then transferred to a reactor by means of a screw conveyor. The reactor, already loaded with sodium, is sealed and heated to 800 °C:

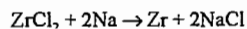

The cooled mass was mechanically broken out of the reactor and leached with water to remove the sodium chloride from the zirconium. However, it was necessary to drip-melt the zirconium, forming splat-cooled chunklets, to remove the last traces of salt.

The Russian practice is to reduce potassium hexafluorozirconate with calcium metal in a sealed bomb. In Canada, zirconium tetrafluoride was reduced with calcium metal in a sealed bomb.

Zirconium oxide can be reduced by calcium or magnesium. Finely divided metal powder is recovered by leaching with cold hydrochloric acid. The powder has 0.3–0.5% oxygen, and would not be ductile or malleable if melted into ingot. The powder particles are 1–8 μm in diameter and are very pyrophoric.

**Electrolysis.** Electrowinning and electrorefining of zirconium have been conducted but are not in commercial use. A pilot electrolysis system tested for zirconium was used commercially for hafnium [21]. A summary of the difficulties in developing an electrolysis process is given in [22].

### 30.4.4 Refining

From 1925 to 1945 the van Arkel and de Boer iodide process was the only consistent method for obtaining pure ductile zirconium metal. Now Kroll zirconium is used for most applications and iodide zirconium is used only when the highest purity is needed. In the iodide process, iodine vapor is reacted with Kroll zirconium sponge or calcium-reduced zirconium metal powder to produce zirconium tetraiodide [23, 24]. The tetraiodide vapor diffuses to a heated filament, usually zirconium wire, where the iodide is thermally dissociated, depositing zirconium and releasing iodine to repeat the cycle:

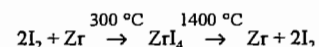

The reaction is conducted in an Inconel vessel at an absolute pressure of 40 Pa. The wire filament diameter grows as zirconium is deposited on the wire. Bars up to 40–50 mm in diameter can be grown.

Electron beam melting is not usually used to purify zirconium because the metal's vapor pressure at its melting point is higher than that of most impurities. Iron and aluminum levels can be reduced by electron beam melting. The metal vapor pressure results in considerable evaporation loss in the high vacuum utilized in electron beam melting.

## 30.5 Fabrication

The procedures for melting zirconium sponge and for conversion of ingots to mill products are similar to those developed by the titanium industry, with the added requirement that high-neutron-cross-section materials such as boron be rigorously excluded.

**Melting.** Zirconium sponge is pressed into compacts, cylindrical or hexagonal discs, which then are stacked and surface-welded together in an electron beam furnace to form an electrode. The discs may be pure sponge, or may contain alloying ingredients added in the midst of each disc during pressing, or may be recycled clean turnings of the same intended composition. The welded electrode is then melted in a vacuum arc furnace. An electric arc is struck between the electrode and a starter pad of zirconium chips in the bottom of a water-cooled cylindrical copper crucible. The electrode is not cooled and it slowly melts off in the arc, producing a molten pool in the cooled copper crucible. The pool edge freezes on contact with the cool crucible wall so that the remaining pool is separated from the crucible wall. As melting continues, the electrode is consumed and the ingot grows in the crucible, cooling and solidifying from the bottom and sides as the pool moves upward. The outer skin contains impurities that vaporize during melting, primarily magnesium and magnesium chloride, and any possible copper pickup from sliding the ingot out of the crucible. The first-melt ingot is surface machined to remove the outer skin. Since the molten pool was, at any one instant, only a small portion of the ingot, distribution of alloying ingredients in the ingot is not homogenous after one melt. Two machined first-melt ingots are formed into a second electrode, first-melt bottom now at the top, which is again melted in a larger diameter copper crucible. A third melt assures complete homogeneity and dissolution of any inclusions. 750 mm diameter ingots of up to 9 t are produced.

**Forming.** Ingots are surface machined then heated to over 1000 °C and hot forged to 50–150 mm thick slabs, or to 200–400 mm diameter rounds. At the conclusion of hot working, the surface oxide scale is removed by sandblasting and abrasive-wheel grinding. The underlying dark layer of oxygen-diffused metal is removed by pickling in dilute hydrofluoric-nitric acid solution [25].

Strip and sheet are formed by cold working the slabs in conventional rolling mills, including producing foil in a Sendzimir mill. The allowable cold deformation before annealing is 20–70%, depending on alloy toughness and the type of deformation process. Intermediate and final anneals are conducted in vacuum or inert-atmosphere furnaces.

For round products, the 200–400 mm rounds are cut to length, hot rotary forged to bar, cleaned, and swaged or drawn to rod or wire for welding use.

For hollow round products, short lengths of the rounds are drilled or trepanned to produce extrusion billets which are warm extruded to heavy wall tubeshells. Prior to extrusion the billets are coated with proprietary layers of glass, graphite, or copper. These coatings minimize oxidation of the surface and function as a lubricant during extrusion, but must be removed before subsequent cold working.

The extruded tubeshells are tube-reduced in pilger mills, with intermediate vacuum anneals, to produce thin-wall tube lengths. Zircaloy 2 or 4 (see Section 30.9) tubes are used as cladding for uranium oxide pellets for light-water nuclear fuel assemblies. This is the major use of zirconium metal.

**Powder Metallurgy.** Malleable zirconium and high-zirconium alloy powders are obtained by the hydride-dehydride process. Zirconium is hydrided by heating to 800 °C and cooling in a pure hydrogen atmosphere. The product is brittle and easily ground to powder in an argon-atmosphere chamber. The hydrogen is then removed by degassing in a vacuum above 650 °C. The metal powder is screened to obtain the desired particle-size distribution. The hydride powder can also be directly pressed and sintered, allowing for hydrogen outgassing.

**Welding.** Zirconium can be welded in argon or helium atmospheres. If welding is not conducted in an inert-gas chamber, the welding fixtures or jigs must be so arranged that argon or helium gas flooding is sufficient to keep air completely away from the welding zone. Care must be taken to avoid oxygen or hydrogen

pickup as these affect the ductility and corrosion behavior of the heat-affected zone. Electron beam welding is used for high-quality welds in repetitive situations such as nuclear fuel assembly.

While zirconium can be welded to titanium, hafnium, niobium or tantalum, joining of zirconium with other metals (i.e., copper, iron, nickel) by fusion welding is not practical because of the formation of brittle intermetallic phases. To join these metals, methods must be used that avoid formation of liquid phases but use mechanical interlocking: friction welding or explosive bonding, which is used for cladding of zirconium lining onto ferrous alloys. Welding of zirconium to titanium, niobium, or tantalum destroys the corrosion resistance.

### 30.6 Hazards in Handling Zirconium Metal

Solid zirconium is not hazardous, but any high-surface-area form of zirconium metal (powder, dust, chips, foil, sponge) is hazardous because of its easy ignition in air and its exothermic reaction with many other elements and compounds.

Zirconium chemical equipment, if used under conditions not recommended, such as sulfuric acid above 80% concentration or strong hydrochloric acid with ferric ion contamination, may suffer intergranular attack. This creates a highly pyrophoric surface layer, usually black, that is ignited easily when dry. The combination of  $\gamma$ -zirconium hydride and metallic particles has been suggested to be responsible for the pyrophoricity. Careful treatment in hot air or steam is recommended to stabilize this surface [26].

The ignition temperature of zirconium powder varies with particle size, method of production, and prior treatment. A < 40 mm powder prepared in inert atmosphere will immediately ignite upon exposure to air, unless it is first slowly exposed such as by gradually back-filling the airlock of a glove box, allowing the heat of surface oxidation to dissipate.

Zirconium powder produced wet, such as by acid leaching of a reduction mass, is usually safe if the water content is > 50%. This prevents localized temperature excursions. The powder should not be allowed to settle and compact for long periods of time, especially when freshly prepared. Hydrogen is still slowly generated, and accumulated gas bubbles in a compact powder mass can insulate some grains from the water, allowing localized heating to ignition.

Drying of wet powder is most hazardous. While wet powder is harder to ignite than dry powder, it burns much more vigorously because of the available oxygen from the water and is more explosive because of the generation of hydrogen and steam. The most hazardous water content is 5–10%. Powder is dried as a thin layer on warm-water-heated trays in a vacuum drier.

Machining of zirconium generates fine chips which can be ignited easily. Hot chips are the usual ignition source. The best metal removal procedures consistent with keeping chip temperatures down are: using slow cutting speeds with heavy feeds, and using an ample flood of water-soluble cutting oil as a coolant. Accumulation of chips should be avoided. Chips should be removed as generated and stored in water-filled drums kept outside in an isolated area. Coarse chips, if not contaminated, possibly may be chopped, cleaned, and recycled. Fine chips should be disposed of by burning in an incinerator or an open pit, feeding the fire in small increments of 1–2 kg.

Many unexpected flash fires have been caused by improper handling of machining chips resulting in more than one incident of fatal flash burns. Workers involved in handling, storing, cleaning, or disposal of machining chips or other zirconium fines should wear heat-reflectant clothing.

Zirconium fires can be controlled only by cutting off the supply of oxygen and other oxidants such as water, carbon dioxide, carbon tetrachloride, iron oxide, and limestone. Small fires can be smothered with dry silica sand or dry table salt, or with argon or helium if the

zirconium is enclosed in a container. Do not use water. Large fires are best left alone and allowed to burn out, keeping the surroundings from igniting.

Safe handling procedures for zirconium, including machining, grinding, welding, and descaling, are discussed in [27].

Solutions that corrode zirconium metal may react violently or explosively with zirconium powder. A solution of 83% concentrated  $H_2SO_4$  and 17%  $KHSO_4$  was added dropwise to 2 g of zirconium powder. Upon adding about 2 mL of the acid mixture, a violent explosion occurred.

### 30.7 Grades and Specifications

There are two parallel grading systems for zirconium: industrial (intended primarily for use as a construction material for equipment and piping in the chemical industry) and nuclear (intended for use as a construction material for fuel cladding and internal parts for nuclear power reactors). Some of these grades have little present usage.

The industrial grades are listed, showing first the ASTM designation, then any alternate designation:

- R 60701 (Zr 701) an unalloyed zirconium of low hardness and containing low levels of the impurities iron and chromium  
 R 60702 (Zr 702) the usual unalloyed zirconium specified for general corrosion-resistant service

R 60703 (Zr 703) the least pure, available only as sponge metal, used primarily for alloying with other metals

R 60704 (Zr 704) an alloy containing tin and iron and used in chemical process applications where the higher strength of the alloy is needed and the corrosion resistance is sufficient

R 60705 (Zr 705) an alloy containing 2.5% niobium used where high strength is needed

R 60706 (Zr 706) a softer version of Zr 705 used specifically for severe forming applications

All of these grades may contain the usual 2% hafnium, or may be furnished hafnium-free. This does not affect the quality or usefulness in industrial applications.

Zirconium for use in nuclear service is supplied to meet individual company specifications (which usually use ASTM nuclear grades and specifications as a starting point). The nuclear grades are listed, showing first the ASTM designation, then any alternate designation:

- R 60001 unalloyed zirconium with a long list of controlled impurities to make it satisfactory for nuclear service. Primarily iodide zirconium for the first reactor core  
 R 60802 (Zircaloy 2) an alloy containing 1.5 Sn, 0.15 Fe, 0.1 Cr, and 0.05 Ni used primarily in pressurized water reactors  
 R 60804 (Zircaloy 4) an alloy containing 1.5 Sn, 0.2 Fe, 0.1 Cr used primarily in boiling water reactors  
 R 60901 (Zr2.5Nb, 705) an alloy containing 2.5 Nb, used primarily for pressure tubes in the Canadian CANDU reactors

All of these grades are hafnium free, i.e., < 100 mg Hf/kg Zr.

U.S. and Canadian specifications for zirconium products are listed in Table 30.3.

Table 30.3: Specifications for zirconium and zirconium alloy products.

Zirconium product	Industrial		Nuclear		
	ASTM	ASME	ASTM	DOE	AECL
Sponge	B494		B349		
Ingot	B495		B350	M10-1T	MET 52
Forgings	B493			M2-9T	
Bar (rod) and wire	B550	SB550	B351	M7-9T	MET 62
Strip, sheet, and plate	B551	SB551	B352	M5-6T	MET 59
Tubes, seamless and welded	B523	SB523	B353	M3-8T	MET 92
Tubes, nuclear fuel cladding			B811		MET 56
Pipe, seamless and welded	B658	SB658			
Welding fittings	B653				
Bare welding rods		SFA2.54*			
Castings	B752				

\* Also American Welding Society spec. A2.54.



## 30.8 Uses

Zirconium is produced almost exclusively as the hafnium-free metal. Most of this metal is used in zirconium alloys containing low levels of tin or niobium, for structural parts in the core of water-moderated nuclear reactors. For this use, zirconium has several desirable attributes: it is ductile, i.e., it can be formed. It has good strength up to 450 °C, i.e., it does not deform at reactor core temperature. Its alloys have hot-water and steam corrosion resistance, i.e., it lasts a long time in normal use. It has low thermal neutron cross section i.e., neutrons are not absorbed, shutting down the nuclear reaction. Its ore is readily available.

Zirconium is used for building chemical process equipment for those applications where its corrosion resistance is needed. In hot sulfuric acid up to 65% concentration, zirconium is used in facilities which produce hydrogen peroxide, acrylic films and fiber, methyl methacrylate, and butyl alcohol. Zirconium is used in the cooler condenser on a nitric acid absorption column. The operation conditions are 200 °C and 1035 MPa. One condenser constructed with zirconium tubes and zirconium/304L stainless steel explosion-bonded tubesheets contains over 18 km of zirconium tubing and has been in service for twelve years. Zirconium is used in contact with ammonium carbamate in urea production, in production of acetic and formic acid, and in many hydrochloric acid environments. In these applications zirconium's corrosion resistance is excellent and the long life of the equipment has justified the use of zirconium.

Zirconium foil, 0.002 mm, is used as the ignition-flash material in photographic flash bulbs, just as zirconium powder used to be one ingredient in the old open "flash pans" of earlier photographers, but this usage is fading because of built-in electronic flashes in newer cameras. Zirconium powder is still used in pyrophoric applications.

Zirconium and zirconium alloys with aluminum, iron, titanium, or vanadium are used for gettering in vacuum tubes [28], inert gases, and ultra-high-purity environments for the

semiconductor industry [29]. Heated zirconium absorbs, traces of oxygen, nitrogen, carbon monoxide, carbon dioxide, and water irreversibly. Hydrogen is reversibly adsorbed. The adsorbed materials diffuse into the bulk of the getter alloy, providing fresh surface for renewed adsorption. For ultra-pure inert gases, getters are used at the point of use to remove contaminants picked up from storage tanks or piping systems. Getters are used in gettering pumps for improving the quality of vacuum in ultra-high-vacuum systems.

Zirconium in the forms of clean, chopped machining chips, crushed sponge or magnesium-zirconium reguli turnings are often used in place of master alloys for zirconium additions to steel melts, super alloys, and nonferrous alloys.

## 30.9 Economic Aspects

**Ores and Minerals.** The four major producing countries for the world's current estimated annual production of  $10^6$  t of zirconium minerals are Australia 50%, South Africa 25%, United States 10%, and Ukraine 6%. Australia and South Africa are the major exporting countries. Europe, Japan, China and the United States are major importers.

There are no zircon mines. Zircon is recovered as a by-product of the extraction of the titanium-containing minerals rutile, ilmenite, and leucocoxene. The producers of these minerals adjust their output to follow paint-market demand for titanium oxide pigment. Therefore, the supply and the demand for zircon are rarely in phase and zircon prices have wide swings. During 1975–1995, zircon prices ranged from \$75 per tonne to over \$1000 per tonne in late 1989. The price during 1990–1995 averaged \$250–300 per tonne, varying with quality.

Consumption of zirconium ores continues its gradual growth. In 1975, world production of zircon was 500 000 t and by 1995 it had essentially doubled. Currently, the growth in demand for zirconium materials is being led by

its use as a opacifier in glazed ceramic tile manufacture.

**Metals.** Less than 4% of the zirconium ores are used in the manufacture of zirconium metals. Since the incident at Three Mile Island, the meltdown at Chernobyl, and the ending of the cold war, the demand for commercial nuclear power and for military naval propulsion systems has diminished. It is estimated that in 1994 total world production was ca. 4000 t, compared to ca. 8000 t in 1982.

The United States has the largest production capacity with two producers: Teledyne Wah Chang in Albany, Oregon (nameplate capacity ca. 3000 t/a) and Western Zirconium in Ogden, Utah (nameplate capacity ca. 1500 t/a). In France, the Compagnie européenne du zirconium (CEZUS), owned jointly by Pechiney, Framatome and Cogema, has a capacity of ca. 2000 t/a. The capacity of the Pripirovsky plant in Ukraine is estimated to be 3000 t/a of calcium-reduced reguli, which is crystal-bar refined at Glasnov, Russia. The Indian plant in Hyderabad has a nameplate capacity of 300 t; production is consumed internally. Japan is not presently producing zirconium sponge.

Prices in 1994 were \$20–28 per kilogram of sponge and \$45–110 per kilogram for cold-rolled sheet, strip, or foil.

## 30.10 Compounds

In anhydrous halide-salt melts zirconium may exhibit valences of 4, 3, 2 or 1, but in aqueous solution its oxidation state is 4+. Zirconium compounds have coordination numbers of 6, 7, or 8. The colorless ion is hydrolyzed in aqueous solution. Because of the ion's high charge and small radius, zirconium has a great tendency to hydrolyze and to form polymers. It is believed that most zirconium in aqueous solution is present as a tetramer  $[\text{Zr}_4(\text{OH})_4]^{8+}$  [30]. Therefore,  $\text{ZrOCl}_2 \cdot 8\text{H}_2\text{O}$ , by formula, is actually  $[\text{Zr}_4(\text{OH})_4 \cdot 7\text{H}_2\text{O}]_4\text{Cl}_8$ . Hydrolysis and further polymerization of these tetramer units occurs with time, by heating, or with decreasing acidity.

True equilibrium may take days or weeks. The following anions are listed with respect to their ability to form complexes with zirconium:  $\text{I}^- \approx \text{Br}^- < \text{ClO}_4^- < \text{Cl}^- < \text{NO}_3^- < \text{SO}_4^{2-} < \text{F}^- \approx \text{C}_2\text{O}_4^{2-} \approx \text{PO}_4^{3-} < \text{CO}_3^{2-} < \text{OH}^-$ .

### 30.10.1 Silicate

Zirconium silicate,  $\text{ZrSiO}_4$ , occurs in nature as the mineral zircon. It can be made by heating an intimate mix of zirconia and silica to just above 1500 °C. The crystals are tetragonal with the zirconia and silica linked through shared oxygen atoms, forming edge-sharing alternating  $\text{ZrO}_8$  triangular dodecahedra and  $\text{SiO}_4$  tetrahedra [31]. Other, more complex silicates are also found in nature (see Section 30.5). Zirconium silicate is resistant to acids, aqua regia and cold alkali solutions. It is readily attacked by sodium oxide, by sodium hydroxide at 600 °C and by reaction with hot alkaline compounds. Above 800 °C zircon is reduced by carbon, the basis for the carbochlorination process.

**Uses.** Zircon's mechanical strength, chemical stability and high melting point make it a desirable refractory. Total world production of zircon was  $(850\text{--}1060) \times 10^3$  t/a for 1990–1995. Of this ca. 35–40% is used in ceramic glazes and enamels, ca. 30–35% in refractories, 15–20% in foundry use, 8–12% in abrasives, and 8–12% in other uses including chemicals, metals and alloys, and glass constituents.

In the largest use, decorative ceramics, milled or micronized zircon is used as an opacifier for tile glazes and porcelain enamels. Zircon's high refractive index gives the glaze a white, opaque appearance.

Zircon is a popular refractory in the glass and steel industries. The glass industry uses fused zircon and AZS (alumina-zirconia-silica) refractories which have a high corrosion resistance to molten glass. The AZS refractories are made by electric furnace fusion of alumina and zircon. The steel industry uses zircon in ladles and continuous casting nozzles. Refractory applications were once the leading markets for zircon but they decreased

significantly following the zircon shortage in the late 1980s. Other less expensive refractories such as alumina spinels were substituted.

Zircon is used in foundries as a basic mold material and as a facing on other mold materials. The high thermal conductivity of zircon gives higher cooling rates than other mold materials. Zircon's high melting point, low coefficient of thermal expansion, and chemical stability make it the preferred mold facing, particularly in precision casting.

Alloyed AZ (alumina-zirconia) abrasives are made from 60–90% alumina-zirconia grains produced by fusing alumina with baddeleyite, or zirconia derived from zircon, in electric arc furnaces. The addition of zirconia toughens the alumina, reducing its brittleness. The abrasives have particular application in the grinding of steel and steel alloys because of high strength, hardness, and surface crystal sharpness, resulting in fast grinding and long wheel life.

Zircon is added to glass for television tubes because of its X-ray absorption properties and its ability to toughen the glass.

### 30.10.2 Oxides

Zirconium oxide occurs naturally as the mineral baddeleyite and is produced by calcining of other zirconium compounds. Three phases are stable at atmospheric pressure: cubic above 2370 °C, tetragonal above 1170 °C, and monoclinic below 1000 °C. Transformation of the monoclinic phase to the tetragonal phase begins at ca. 1050 °C and is complete at ca. 1170 °C. The transformation is accompanied by a volume shrinkage of 3–5%. The transformation has a thermal hysteresis: on gradual cooling the tetragonal phase is stable to ca. 1000 °C and only finishes conversion to monoclinic at ca. 800 °C. With rapid quenching the tetragonal phase is metastable to room temperature.

The high-temperature cubic phases can be stabilized down to room temperature by the addition of magnesia, calcia, yttria, or rare earth oxides, whose presence creates vacancies in the zirconium anion lattice. These sta-

bilized zirconium oxides contain from 3% yttria to 8% calcia. They have the same crystal structure from room temperature to melting, avoiding the catastrophic mechanical failure suffered by pure zirconia ceramic parts on transforming from the tetragonal to monoclinic phase while cooling.

Later, GARVIE [32] discovered that certain partially stabilized zirconias could be thermally cycled to precipitate metastable tetragonal zirconia within the grains of cubic zirconia. These materials had higher toughness than fully stabilized zirconias. The increased toughness of partially stabilized zirconia (PSZ) is the result of stress-induced martensitic transformation of the metastable tetragonal grains to the monoclinic form in the stress field of a propagating crack. This led to development of an entirely tetragonal zirconia, known as tetragonal zirconia polycrystal (TZP). The evolution of these materials and their growing application in structural ceramics can be followed in [33–38]. An introduction to zirconia ceramics is given in [39].

Zirconia also has a high-pressure (10 GPa) orthorhombic structure which can be stabilized to atmospheric pressure by addition of > 12 mol% of niobia or tantalum or a mixture thereof [40]. No transformation toughening was found [41].

Stable lower oxides of zirconium are not known, although oxygen dissolved in the zirconium metal lattice has led to the identification of some superstructures as  $ZrO_{0.3}$  [42]. Zirconium monoxide,  $ZrO$ , has been observed in mass spectrographic measurements [43]. The black oxide surface on zirconium metal after exposure to water at 350 °C is a slightly substoichiometric  $ZrO_{1.95}$ .

Zirconia is very resistant to acids and alkalis, but slowly dissolves in concentrated hydrofluoric acid or hot concentrated sulfuric acid. Zirconia is resistant to many fluxes, molten glasses, or melts, silicate, phosphate, or borate, but is attacked by fluoride or alkaline melts. Zirconium oxide and alkaline oxides or caustics can be fired together to form solid-solution oxides, zirconate compounds, or a mixture of both.

Zirconium oxide is reduced by carbon, beginning at ca. 600 °C. With excess carbon, in a vacuum furnace, the reaction proceeds rapidly to zirconium carbide at 1500 °C. In the presence of chlorine the carbon reduction gives zirconium tetrachloride and carbon dioxide.

**Uses.** Zirconium oxide is used to coat the surface of titanium oxide pigment particles for some grades of exterior service paints. The coating minimizes ultraviolet excitation of the titania, which would interact with the organic paint binder, shortening the service life. Zirconia has been used in place of titania as the pigment of white camouflage paints for use in snow environments because zirconia more closely simulates snow in the infrared and microwave spectra. Over 300 t of single-crystal cubic zirconia are grown each year to provide low-cost gems for the jewelry trade [44]. Stabilized zirconia is being used in everyday applications such as fishing rod ferrules, knives, unbreakable shirt buttons, and golf putter heads.

While stabilized zirconias are insulators at room temperature, at elevated temperatures the vacancies in the anion lattice allow  $O^{2-}$  ions to diffuse and the zirconia becomes a solid electrolyte with applications in oxygen sensors and high-temperature fuel cells. Some stabilized zirconias can be used as resistors or susceptors. Inductively heated yttria-stabilized zirconia cylinders are used as heat sources to melt quartz boules for the drawing of quartz optical fibres.

Zirconia is a constituent of lead zirconate titanate (PZT) used in piezoelectric ceramics for applications as gas furnace and barbecue igniters, microphone and phonograph crystals, ultrasonic transducers for medical ultrasound imaging, for agitation in cleaning tanks, and for underwater sonar. With the further addition of lanthanum (PLZT), ferroelectric optically active transparent ceramics have become available [45].

**Hydrous Oxide.** Neutralization of an aqueous zirconium solution causes hydrolysis and condensation of the zirconium cations, forming a

white gel called zirconium hydroxide but generally considered to be a hydrous oxide. The freshly precipitated amorphous gel is generally considered to be a network of tetramer units  $[Zr_4(OH)_8 \cdot 16H_2O]^{8+}$  linked through hydroxyl groups; it is easily dissolved by dilute or weak acids. As the gel ages some of the hydroxyl links are converted to oxo links, and the gel's reactivity decreases. Upon heating to 500 °C the gel yields monoclinic or metastable tetragonal oxide, or a mixture of these. The specific structure obtained has been attributed to the precursor zirconium salt [46], pH of the liquid in final contact with the condensed gel [47], electronegativity and pH [48], slow or rapid condensation from sol to gel, ageing, the presence during gelling of sulfate, sodium, potassium, or ammonium ions, and particle size [49].

Hydrous zirconium oxide in controlled particle size is prepared by hydrolysis of sodium zirconate [50].

Hydrous zirconium oxide sol is used in sol-gel processes to produce stabilized zirconias in spherical or fibrous form, and to form an oxidation-protective film on stainless steels.

### 30.10.3 Chlorides and Hydroxide Chlorides

The fully chlorinated form of zirconium is zirconium tetrachloride. The tetrachloride is normally produced by carbochlorination of zircon or zirconia [51] or by reacting zirconium metal with chlorine or hydrogen chloride. Chlorinated hydrocarbons, particularly carbon tetrachloride, chloroform, or hexachloroethane, are useful laboratory chlorinating agents. Zirconium tetrachloride can be formed by reacting ferrozirconium or silicozirconium with iron(II) chloride at elevated temperature [52].

Zirconium tetrachloride vapor is a tetrahedral monomer which crystallizes below 331 °C in a  $AB_4$  type structure with  $ZrCl_6$  octahedra coupled to each other by two edges to form a zigzag chain. Each zirconium has four bridging chlorine ligands and two terminal chlorines which are mutually *cis* [53]. Some

physical properties of zirconium tetrachloride are shown in Table 30.4.

**Table 30.4:** Physical properties of zirconium tetrahalides.

Property	ZrF <sub>4</sub>	ZrCl <sub>4</sub>	ZrBr <sub>4</sub>	ZrI <sub>4</sub>
Color	white	white	white	orange-yellow
Density, kg/m <sup>3</sup>	4430	2800	3980	4850
Sublimation temperature (101.3 kPa)	903	331	357	431
Melting point, K	923	437	450	499
Critical temperature, K	932	503.5	532	686
Critical pressure, MPa		5.7	4.3	4.1
Crystal structure	mono-clinic	mono-clinic	cubic	cubic

Zirconium tetrachloride reacts rapidly with water, vapor or liquid, to exchange two chlorines for oxygen. Any handling of zirconium tetrachloride must be in moisture-free atmospheres to avoid degradation. Zirconium tetrachloride powder fed into water hydrolyzes to form a solution of zirconium hydroxide chloride and free hydrochloric acid. Zirconium tetrachloride vapor reacts with steam to yield zirconium oxide, and reacts with water to yield either an oxide slurry or hydroxide chloride solution.

Zirconium tetrachloride is used to form zirconium nitride coatings, to react electrochemically to form zirconia in high-temperature fuel cells, to react with alcohols to form alkoxides, and to produce zirconium organometallic compounds. Zirconium tetrachloride is reduced by molten alkali and alkaline earth metals, yielding zirconium metal.

Zirconium tetrachloride reacts reversibly with ammonium chloride, alkali metal chlorides, and alkaline earth chlorides to form hexachlorozirconates [54, 55]. Zirconium tetrachloride forms addition compounds with aluminum and iron trichlorides and phosphorus pentachloride, but FeZrCl<sub>6</sub> dissociates to FeCl<sub>2</sub> and ZrCl<sub>4</sub> above 350 °C.

Lower valent zirconium chlorides including zirconium trichloride, dichloride, monochloride, and zirconium chloride cluster phases Zr<sub>6</sub>Cl<sub>12</sub> and Zr<sub>6</sub>Cl<sub>15</sub> are produced by reduction of zirconium tetrachloride with zirconium metal or with zirconium monochloride in sealed tantalum containers. The reactions are slow, usually requiring weeks at 300 to

800 °C [56–58]. Zirconium monochloride reacts reversibly with hydrogen at 340 °C in a sealed tube to form ZrClH<sub>x</sub> (x ≤ 1) [59].

**Hydroxide Chlorides.** Zirconium hydroxide dichloride, empirically Zr(OH)<sub>2</sub>Cl<sub>2</sub>·7H<sub>2</sub>O, has been known by several names: zirconyl chloride, zirconium oxychloride, zirconium oxide dichloride, all commonly identified as ZrOCl<sub>2</sub>·8H<sub>2</sub>O. Structurally the hydroxide dichloride is really [Zr<sub>4</sub>(OH)<sub>8</sub>·16H<sub>2</sub>O]Cl<sub>8</sub>·12H<sub>2</sub>O [60].

Zirconium hydroxide dichloride solution is formed by dissolving hydrous zirconium oxide or zirconium carbonate in hot hydrochloric acid, or by hydrolysis of zirconium tetrachloride in water. The solubility in hot water is quite high and the solubility is decreased by cooling and by adding hydrochloric acid. Excellent recoveries are obtained by crystallization ending with a 6 N hydrochloric acid mother liquor. This crystallization procedure also leaves most impurities dissolved in the mother liquor. Crystallization may be repeated to obtain very pure crystals.

Zirconium hydroxide dichloride crystals dissolve in their hydration water on gentle heating, and readily lose the hydrates outside the tetramer unit. With continued heating both water and hydrogen chloride are evolved until zirconium oxide remains [61, 62].

Zirconium hydroxide monochloride, [Zr<sub>4</sub>(OH)<sub>12</sub>·16H<sub>2</sub>O]Cl<sub>4</sub>, is formed in solution by reacting equimolar portions of zirconium hydroxide dichloride and hydrous zirconium oxide or zirconium basic carbonate, or by the action of hydrogen peroxide upon zirconium hydroxide dichloride [63].

Anhydrous zirconium oxide chlorides have been prepared: the reaction of zirconium dioxide with zirconium monochloride at 980 °C produced ZrClO<sub>y</sub> (y < 0.42) [64]. The reaction of zirconium tetrachloride powder in carbon tetrachloride with dichlorine oxide at -30 °C yielded ZrOCl<sub>2</sub>, which dissociated to ZrCl<sub>4</sub> and ZrO<sub>2</sub> above 200 °C [65].

### 30.10.4 Bromides

Zirconium tetrabromide, ZrBr<sub>4</sub>, can be prepared by heating zirconium metal or carbide above 400 °C in a stream of bromine, or similarly a fine mixture of zirconium oxide and carbon at 900 °C. Its behavior is similar to zirconium tetrachloride but, because of its higher cost, the tetrabromide is of little commercial interest. Some physical properties are shown in Table 30.4.

Zirconium tribromide, zirconium dibromide, zirconium monobromide, and zirconium monobromide hydride can be made by the same procedures used for their chloride analogues [66].

### 30.10.5 Iodides

Zirconium tetraiodide, ZrI<sub>4</sub>, is important because of its use in the van Arkel-de Boer refining process. The tetraiodide cannot be produced by heating fine zirconium oxide and carbon in iodine vapor, but is produced by heating zirconium metal to 300 °C in iodine. A temperature of ca. 1000 °C is required for a reasonably rapid reaction of iodine with zirconium carbide, carbonitride, or nitride. Zirconium tetraiodide is oxidized by dry air at about 200 °C. Some physical properties are shown in Table 30.4.

Lower-valence iodides have been made by reduction of zirconium tetraiodide with zirconium in sealed tantalum tubes or with zirconium or aluminum in aluminum iodide solvent [67]. Compounds formed include zirconium triiodide, zirconium diiodide ii (both α monoclinic and β orthorhombic forms), zirconium clusters Zr<sub>6</sub>I<sub>12</sub>, and zirconium monoiodide [68].

### 30.10.6 Fluorides

There are several methods for the production of zirconium tetrafluoride, ZrF<sub>4</sub>. Anhydrous zirconium tetrafluoride is produced in good purity by mixing hydrogen fluoride gas and zirconium tetrachloride vapor at 350 °C [69]. The hydrofluorination of zirconium oxide proceeds rapidly at 25 °C, followed by a

purifying sublimation in dry hydrogen fluoride at 825 °C [70]. Zirconium tetrafluoride monohydrate is precipitated by adding strong hydrofluoric acid to a concentrated zirconium nitrate/nitric acid solution. The filtered crystals are washed with nitric acid, dried, and dehydrated with hydrogen fluoride at 450 °C [71]. Zirconium metal or zirconium hydride can be fluorinated with hydrogen fluoride but unless the reaction is conducted above 800 °C, the tetrafluoride products coats the metal, impeding the reaction. Zirconium oxides mixed with ammonium hydrogen difluoride and heated to 200 °C yields ammonium heptafluorozirconate, (NH<sub>4</sub>)<sub>3</sub>ZrF<sub>7</sub>, which, on heating to 500 °C, gives off ammonium fluoride. Some physical properties of zirconium tetrafluoride are shown in Table 30.4.

Zirconium tetrafluoride is hydrolyzed in water to a hydroxide fluoride Zr<sub>4</sub>(OH)<sub>6</sub>F<sub>10</sub>·3H<sub>2</sub>O with limited solubility. With increasing hydrofluoric concentration, ZrF<sub>4</sub>·3H<sub>2</sub>O crystallizes at 30–35% HF, HZrF<sub>5</sub>·4H<sub>2</sub>O at 30–35% HF, and H<sub>2</sub>ZrF<sub>6</sub>·2H<sub>2</sub>O at 40–60% HF. In strong nitric or sulfuric acid containing excess hydrofluoric acid, the monohydrate crystallizes. Heating these hydrates produces ZrOF<sub>2</sub> at 300 °C.

Very high purity anhydrous zirconium tetrafluoride is a major constituent of some fluoride glasses, particularly ZBLAN, being developed because their transparency for near UV to mid IR (0.3–6 μm) was projected to be better than that of quartz optical fiber.

Potassium hexafluorozirconate production by fluorosilicate fusion is described in Section 30.6. This compound has been used to introduce zirconium into molten aluminum and magnesium as a grain refiner.

As mentioned in Section 30.7, zirconium metal is customarily pickled in dilute hydrofluoric acid/nitric acid solution. To minimize fluoride waste discharge the pickling solution is regenerated by adding sodium fluoride to precipitate sodium fluorozirconates. The particular salt precipitated varies with the sodium fluoride concentration: NaZrF<sub>5</sub>·H<sub>2</sub>O is precipitated when the sodium fluoride concentration is less than 0.21%, and Na<sub>2</sub>ZrF<sub>6</sub> is precipitated

if the sodium fluoride concentration is between 0.21 and 0.4%. At higher sodium fluoride concentration  $\text{Na}_3\text{Zr}_2\text{F}_{13}$  and  $\text{Na}_3\text{ZrF}_7$  precipitate.

Zirconium tetrafluoride forms many double fluoride compounds in different proportions with alkali fluorides, alkaline earth fluorides, and others as diverse as stannous hexafluorozirconate and zirconium hexafluorogermanate, both proposed for caries prophylaxis.

### 30.10.7 Sulfates

The sulfates of zirconium are classified as anionic, normal, or basic, depending on the sulfate to zirconium ratio. For anionic complexes this ratio is  $> 2$ . Normal sulfates have a ratio of exactly two, and basic sulfates have less than two sulfates per zirconium. Basic sulfates made by hydrolysis of neutral sulfates usually have a ratio  $> 1$ , while basic sulfates precipitated by adding sulfate ions to hot dilute solutions of zirconium hydroxide chloride have a ratio  $< 1$ , usually 0.4–0.7.

Zirconium sulfate solutions can be generated by the action of strong sulfuric acid on hydrous zirconium oxide, zirconium oxide, zirconium carbonitride, zirconium metal, or basic zirconium sulfate. Normal zirconium sulfate,  $\text{Zr}(\text{SO}_4)_2 \cdot 4\text{H}_2\text{O}$ , also known as zirconium orthosulfate, can be crystallized from the above solution, or from a zirconium hydroxide chloride solution by adding sulfuric acid up to a concentration of 45% and allowing the solution to cool below 60 °C. A better purification is obtained during the crystallization if the solution contains some chloride ion.

Ammonium zirconium sulfates can be prepared by heating zirconium oxide with ammonium sulfate at 400 °C [72] or by precipitation from a zirconium sulfate solution [73]. A crude sodium zirconium sulfate can be prepared by adding sulfuric acid to sodium zirconate. Structure and composition of many sulfate variants are discussed in [30, 74, 75].

Basic zirconium sulfates containing less than one sulfate per zirconium are precipitated from hot acidic solutions of zirconium hydroxide chloride by adding 0.4–0.6 mol of sul-

fate per zirconium. The stoichiometric formula is  $\text{Zr}_5\text{O}_{10-x}(\text{SO}_4)_x$  ( $x = 1.8\text{--}3.5$ ). The most common basic sulfate is  $\text{Zr}_5\text{O}_7(\text{SO}_4)_3 \cdot n\text{H}_2\text{O}$ .

Normal zirconium sulfate is used for leather tanning, as a catalyst, to coat titanium oxide pigment powder, and for conversion to other zirconium chemicals. The basic sulfate is converted into other zirconium chemicals, many retaining the particle size developed during the controlled precipitation of the basic sulfate.

### 30.10.8 Carbonates

Basic zirconium carbonate is produced by adding basic zirconium sulfate to a sodium carbonate solution, and filtering the insoluble basic carbonate. The empirical formula is  $\text{ZrO}_2 \cdot \text{CO}_2 \cdot x\text{H}_2\text{O}$  but the zirconium to carbonate ratio varies considerably.

The basic carbonate is reacted with organic acids to make soluble zirconium salts, such as the citrate, oxalate, and acetate, free of chloride and sulfate ions. The carbonate is used to make a zirconium–aluminum–glycine complex, an active ingredient of antiperspirant formulations.

Zirconium basic carbonate is added to potassium carbonate or ammonium carbonate solutions to make water-soluble double carbonates. At room temperature, these solutions hydrolyze so slowly that they are considered to be stable for a month, but on heating carbon dioxide evolves and insoluble hydrous zirconium oxide forms. Ammonium zirconium carbonate, empirically  $(\text{NH}_4)_3[\text{Zr}_2\text{O}(\text{OH})_3(\text{CO}_3)_3]$  is used extensively in bonding starch onto coated paper [76], and in controlling pitch deposition in pulp and papermaking systems [77].

### 30.10.9 Hydride

Zirconium hydride,  $\text{ZrH}_2$ , is prepared by the reversible absorption of hydrogen into heated zirconium, usually sponge or ingot slices. The metal is heated above 600 °C in an inert atmosphere or vacuum to dissolve the

surface oxide film, then hydrogen is introduced. At 600 °C, hydrogen dissolves into the  $\alpha$ -phase metal up to 6 atom%, when  $\beta$ -Zr appears. (Hydrogen is a  $\beta$ -phase stabilizer, lowering the transformation temperature from 863 to 550 °C). At 40 atom% the solubility in  $\beta$ -Zr is exceeded and  $\delta$ -phase hydride appears. At 60–64 atom% only  $\delta$  phase exists. Above 64 atom% the tetragonal  $\epsilon$ -phase is stable [78]. To obtain fully hydrided  $\text{ZrH}_2$  the charge is cooled to 300 °C in full hydrogen atmosphere.

The reduction of zirconium oxide with calcium hydride yields a fine (2–5  $\mu\text{m}$  particles) hydride powder for use in pyrotechnics such as fuses or fireworks:

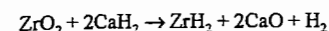

Extreme care must be used in dissolving the calcium oxide to recover the hydride powder.

Hydriding of zirconium sponge or ingot is the first step in producing coarse zirconium powder for powder metallurgy applications. Hydrided metal begins to lose its ductility above 40 atom% hydrogen, and above 60 atom% the hydrided metal is quite brittle and suitable for crushing, which is conducted in an inert atmosphere. During hydriding, the metal density decreases with increasing hydrogen content, going from 6.5 to 5.6 when fully hydrided.

Zirconium hydride loses hydrogen upon heating. For complete dehydriding the powder must be heated under vacuum (e.g., 700 °C until the vacuum falls to  $10^{-3}$  Pa). Dehydriding is faster at higher temperatures but the powder begins to sinter.

Zirconium hydride contains about the same number of hydrogen atoms per volume as room-temperature water, and some alloys such as  $\text{ZrNi}$  and  $\text{ZrCr}_2$  can hold even more [79]. Zirconium hydride has been used in the nuclear industry as a moderator for thermal neutrons in compact, high-temperature reactors. Zirconium hydride is of interest for hydrogen storage and nickel-base hydrogen battery applications.

Zirconium hydride is inert to air and water at room temperature. It ignites in air at 340 °C or lower, depending on powder size. Zirconium

hydride is resistant to corrosion by carbon dioxide up to 315 °C.

Zirconium hydride heated with carbon yields the hexagonal zirconium carbohydride,  $\text{ZrC} \cdot \text{ZrH}_{1.46}$  [80]. Zirconium monochloride reversibly absorbs hydrogen up to  $\text{ZrClH}$  [81].

### 30.10.10 Carbide

Zirconium carbide,  $\text{ZrC}$ , is a hard, brittle metallic carbide. It is an electrical conductor and does not hydrolyze in water. It is an interstitial carbide with the carbon atoms occupying the octahedral interstices of the zirconium lattice, at 2000 °C, carbon is soluble in liquid zirconium up to 38.5 atom%. Zirconium carbide is a single phase within the concentration range of 38.5–49.4 atom% carbon with a congruent composition of 44 atom% carbon at the melting point of 3445 °C [82, 83].

Zirconium carbide can be produced from zircon by reduction with coke in electric arc furnaces [84]. An intimate mix of fine zirconium oxide and carbon black heated in vacuum or hydrogen in an induction-heated graphite crucible at 1600 °C yields a porous, light zirconium carbide. Milling and refiring above 2200 °C gives a dense powder. Zirconium tetrachloride and methane in a hydrogen atmosphere are heated to 1200 °C to deposit zirconium carbide films on tool bits. Pure zirconium metal powder and fine graphite powder react exothermically, once ignited, to form zirconium carbide, usually to form a composite with an excess of one reagent.

### 30.10.11 Nitrides

Zirconium nitride,  $\text{ZrN}$ , is a golden-colored, hard, brittle metallic nitride. It is thermally and chemically stable, and has low resistivity. As with the carbide it is an interstitial compound with a NaCl cubic structure. At 2000 °C, nitrogen is soluble in liquid zirconium up to 39 atom% nitrogen. Zirconium nitride is a single phase within the concentration range of 39–50 atom% nitrogen [85, 86]. While 3253 K is the accepted melting point of zirconium nitride, the melting temperature of

3970 K as measured in a positive pressure of nitrogen [87] is compatible with a thermodynamic study of the Zr-N system.

Zirconium nitride has been made by heating zirconium or zirconium hydride powder in nitrogen at 1000 °C, and by heating a zirconium oxide/carbon mixture in a nitrogen atmosphere. The reaction of zirconium tetrachloride with ammonia or nitrogen and hydrogen has been used to produce nitride powder and to deposit coherent films on substrates at 1000–1200 °C. Very limited quantities of nitride have been made by the very exothermic reaction of lithium nitride and zirconium tetrachloride powders [88].

Metastable  $Zr_3N_4$  has been made by dual ion beam deposition [89] and by reacting zirconium tetraiodide with ammonia at 500 °C and heating the product to  $Zr_3N_4$  at 700 °C [90]. On further heating to 1000 °C ZrN is formed. Thin films of  $Zr_3N_4$  have been grown by passing ammonia and tetrakis(diethyl-amido)zirconium over substrates at 200–400 °C [91].

Zirconium nitride has been used as a wear-resistant coating on steel drill bits and cemented-carbide tool bits, as decorative coating, as a protective coating on steel vessels handling molten metal, and as solar energy collector surface film.

### 30.10.12 Borides and Borates

While three zirconium borides, ZrB, ZrB<sub>2</sub>, and ZrB<sub>12</sub> are found in the zirconium-boron system, only the diboride is chemically and thermally stable. Zirconium diboride is a gray refractory solid with a hexagonal crystal structure and a very high melting point of 3245 °C. Technical-quality zirconium diboride can be prepared by reacting zircon, boron oxide, and carbon in a submerged-electrode arc furnace [92]. Purer diboride can be produced by co-reduction of zirconium tetrachloride and boron trichloride with hydrogen or aluminum in a chloride bath. Zirconium diboride films can be produced by subliming zirconium tetrahydridoborate at 25 °C in a vacuum and passing the vapor over a substrate heated to 250 °C.

Zirconium diboride has high hardness, good oxidation resistance, and excellent thermal-shock resistance. It has been used as a diffusion barrier in semiconductors, as a container for molten metals, and as a burnable absorber in nuclear reactor cores.

**Zirconium tetrahydridoborate**, Zr(BH<sub>4</sub>)<sub>4</sub>, is prepared by reaction of zirconium tetrachloride with lithium tetrahydridoborate in diethyl ether, followed by double distillation at 20 °C [93]. It has a tetrahedral structure with three hydrogen atoms bridging the zirconium atom and each boron atom. Zirconium tetrahydridoborate is one of the most volatile zirconium compounds known: *mp* 29 °C; *bp* 118 °C; vapor pressure 2 kPa at 25 °C. Its decomposition near 250 °C forms the basis for a low-temperature method of depositing zirconium boride films. Zirconium tetrahydridoborate catalyzes the polymerization of unsaturated hydrocarbons. It reacts with aliphatic alcohols to form zirconium and boron alkoxides [94]. Zirconium tetrahydroborate inflames on contact with dry air.

### 30.10.13 Tungstate

Zirconium tungstate is precipitated as a white gel by simultaneous addition of dilute solutions of sodium tungstate and zirconium hydroxide dichloride to vigorously stirred water. After acidification the slurry is refluxed. The dried and fired product is ZrW<sub>2</sub>O<sub>8</sub> [95]. Other studies indicate that ZrW<sub>2</sub>O<sub>8</sub> is formed by the reaction of a mixture of ZrO<sub>2</sub> and WO<sub>3</sub> which is held between 1100 and 1400 °C for at least 24 h melts incongruently at 1257 °C and dissociates below 1105 °C [96]. ZrW<sub>2</sub>O<sub>8</sub> is an unusual compound which contracts equally in each dimension when it is heated over the temperature range 1–1050 K [97].

### 30.10.14 Phosphate

Insoluble, amorphous zirconium phosphate is obtained when a zirconium salt is added to an excess of phosphoric acid. If the original salt was solid rather than in solution, the resulting phosphate will have a similar

physical size and shape: i.e., beads, granules, fibers. Refluxing the precipitate in strong phosphoric acid gives a crystalline product of constant composition, Zr(HPO<sub>4</sub>)<sub>2</sub>·H<sub>2</sub>O. Zirconium bis(monohydrogenphosphate) with one water of hydration is known as  $\alpha$ -zirconium phosphate. Below 80 °C a second water of hydration is added to form  $\gamma$ -zirconium phosphate. On heating  $\alpha$ -zirconium phosphate, the water is lost between 300 and 650 °C, leaving  $\beta$ -zirconium phosphate. Conversion to zirconium pyrophosphate, ZrP<sub>2</sub>O<sub>7</sub>, occurs between 800 and 920 °C [98].

Zirconium bis(monohydrogenphosphate) has ion exchange properties and, because of its structure and bonding between layers, can also act as an intercalation compound [99]. Zirconium phosphate shows excellent catalytic activity for the selective condensation of acetone to mesityl oxide, and when palladium is deposited on the phosphate surface the combination is an effective catalyst for the direct synthesis of methyl isobutyl ketone from acetone and hydrogen [100].

The addition of univalent ions Li, Na, K and compensating trivalent ions In, Y, Eu into ZrP<sub>2</sub>O<sub>7</sub> produces a solid electrolyte [101]. Ultralow thermal expansion ceramics have been developed in the Na<sub>2</sub>O–ZrO<sub>2</sub>–P<sub>2</sub>O<sub>5</sub>–SiO<sub>2</sub> system [102], while the addition of vanadium to sodium zirconium pyrophosphate: Na<sub>2</sub>PrP<sub>2</sub>-xV<sub>x</sub>O<sub>7</sub> yields a ceramic which shrinks when heated above 60 °C [103].

### 30.10.15 Nitrates

Zirconium hydroxide dinitrate, Zr(OH)<sub>2</sub>(NO<sub>3</sub>)<sub>2</sub>, is formed by dissolving hydrous zirconium oxide in nitric acid or by dissolving zirconium hydroxide dichloride in nitric acid and distilling off the chlorine.

Zirconium tetranitrate, Zr(NO<sub>3</sub>)<sub>4</sub>·5H<sub>2</sub>O, can be precipitated from strong nitric acid at low temperature, less than 15 °C [104].

### 30.10.16 Carboxylates

Zirconium hydroxide carboxylates form upon adding carboxylate salts to a solution of

zirconium dihydroxide chloride, or carboxylic acids to zirconium basic carbonate. The general formula is Zr(OH)<sub>4-n</sub>(OOR)<sub>n</sub>, where *n* is 1–3 usually.

When zirconium basic carbonate paste is slowly stirred into a mineral spirit solution of octanoic acid, a solution of zirconium dihydroxide octanoate is produced which is of use in oil-based paints as a dryer catalyst.

Short-chain carboxylates may be soluble, i.e., zirconium dihydroxide diacetate. Longer aliphatic chain carboxylates (zirconium soaps) are water insoluble [105].

### 30.10.17 Alkoxides

Zirconium alkoxides are prepared by adding zirconium tetrachloride to anhydrous alcohols [106]:

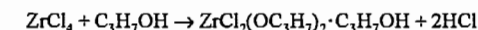

If there is no steric hindrance, all four chlorines can be exchanged if ammonia is added to combine with the hydrogen chloride.

Alkoxides of different alcohols can be formed by alcohol exchange. This can be facilitated by removal of the more volatile alcohol, or a lower-boiling azeotrope with an inert solvent such as benzene. The conversion of zirconium tetramethoxide by refluxing with tertiary butanol proceeds only to zirconium methoxide tri-*tert*-butoxide because of steric factors. The following order was found in the interchange of alkoxy groups:

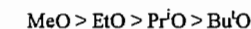

The reaction of *tert*-butanol with zirconium tetrahydridoborate yielded a double alkoxide complex of zirconium *tert*-butoxide with bis(*tert*-butoxy) borane [94].

Zirconium alkoxides hydrolyze quite easily. This provides a route to high-purity, high-surface-area zirconium oxide.

### 30.11 Analysis

Analysis for zirconium in ore, soil, vegetation in compounds, and as a minor alloying constituent involves bringing the zirconium into solution, then precipitating with mandelic

acid [107] and firing the precipitate to oxide. For the determination of zirconium in air samples, plasma emission spectroscopy is used.

Methods to determine the hafnium associated with the zirconium include atomic absorption spectroscopy, emission spectroscopy, mass spectroscopy, X-ray spectroscopy, and neutron activation.

Most impurities in zirconium and zirconium compounds are determined by emission spectroscopy, with arc-spark [108] or plasma excitation [109, 110]. Atomic absorption is also used to determine a variety of impurities [111].

Carbon and sulfur in zirconium are measured by combustion followed by chromatographic or IR determination of the oxides [112]. Hydrogen is determined by thermal conductivity after hot-vacuum extraction, or by fusion of zirconium with a transition metal in an inert atmosphere and subsequent separation by gas chromatography [113, 114].

Simultaneous determination of oxygen and nitrogen is accomplished by fusion of zirconium with a transition metal in the presence of carbon in an inert atmosphere and subsequent separation by gas chromatography [115, 116]. Nitrogen can be determined by the Kjeldahl technique [112].

Phosphorus may be determined by visible spectrophotometry using molybdenum blue [112] but can be determined more rapidly by phosphine, evolution and name emission spectroscopy.

Chloride at low level is determined indirectly by precipitation with silver nitrate and determination of the silver by X-ray or atomic absorption spectroscopy. Fluoride and higher levels of chloride can be measured by selective ion electrode techniques [117, 118].

## 30.12 Toxicology

Zirconium and its compounds are generally of low toxicity. However, the strongly acidic compounds such as zirconium tetrabromide, zirconium tetrachloride, zirconium tetrafluoride, zirconium tetraiodide, zirconium tetra-

trate and zirconium sulfate are strongly corrosive to eyes, lungs, skin, mouth, esophagus, and stomach. Exposure to these compounds should be avoided, not because they contain zirconium, but because of the acidic nature of their hydrolysis products generated upon contact with animal or plant tissue.

Inhalation of zirconium materials in the workplace has not resulted in significant toxicity in 40 years of considerable exposure if reasonable care was used. One case of pulmonary fibrosis is believed to have been induced by heavy and continued exposure to zirconium oxide dust while preparing slurries for lens polishing which developed after a 15-year latency period [119]. Severe respiratory tract irritation from inhaling zirconium acetoacetate disappeared after exposure ceased [120]. In 1978 the FDA banned the production of antiperspirant aerosols containing zirconium because of concern about possible lung granulomas.

Inhalation laboratory tests with insoluble zirconium oxide varied. Some showed no effect, some caused fibrosis. Russian tests with the insoluble compounds zirconium boride [121] and zirconium hydride [122] both showed fibrogenic action in the lungs of albino rats. Aerosols of soluble zirconium dihydroxide chloride and zirconium dihydroxide nitrate each caused intense irritation of upper breathing passages similar to the action of strong acid. The animals died with 30–40 min. Sodium zirconium lactate caused lung granulomatosis in rabbits [123], and it is indicated that a complex of zirconium chlorhydrate and aluminum chlorhydrate also induces granulomatous lung changes [124].

Antiperspirants and poison ivy remedies containing zirconium have caused skin granulomas as a delayed hypersensitivity reaction in a few users [125].

Toxicity tests on laboratory animals showed that the acute toxicity of inorganic zirconium salts is very low when administered orally. Administered intraperitoneally, both organic and inorganic compounds were 2–20 times more toxic.

An excellent summation of zirconium toxicology through 1975 is available [126]. Toxicity data for some zirconium compounds is shown in Table 30.5.

Table 30.5: Toxicity data (rat) for some zirconium compounds [127].

Compound	Oral LD <sub>50</sub> , mg/kg	Inhalation LCLo, mg/m <sup>3</sup>
Dihydroxide chloride	3500	500 for 30 min
Dihydroxide nitrate	2290	500 for 30 min
Sulfate	3500	
Tetrachloride	1688	3124 ppm HCl for 1 hour
Acetate	4100	

The OSHA exposure limit for zirconium and zirconium compounds as airborne particulate is 5 mg/m<sup>3</sup> TWA and 10 mg/m<sup>3</sup> STEL, as zirconium. In Germany, the MAK is 5 mg/m<sup>3</sup> as zirconium. In Russia, MAK is 6 mg/m<sup>3</sup> as zirconium.

## 30.13 Storage and Transportation

High-surface-area zirconium metal such as sponge or powder is a combustible solid which should be kept dry and stored away from sources of ignition and oxidizers.

The Department of Transportation has classified all dry zirconium powder as "spontaneously combustible", hazard class 4.2, with identification number UN 2008. The powders are subdivided into packing group I, II, or III, as evaluated by their burning rate in a standardized testing procedure. Group I is for very fine zirconium powder which is a pyrophoric material. Group I powder may not be shipped by air.

Some zirconium powder, usually fuse powder, is recovered wet and shipped wet. This powder is classified as a flammable solid, hazard class 4.1, UN 1358.

- Zirconium hydride is classified as a flammable solid, hazard class 4.1, UN 1437.
- Zirconium nitrate is classified as an oxidizer hazard class 5.1, UM 2728.
- Zirconium sulfate is classified as corrosive hazard class 8, NA 9163.

- Zirconium tetrachloride is classified as corrosive, hazard class 8, UN 2503.

## 30.14 References

1. A. E. van Arkel, J. H. de Boer, *Z. Anorg. Allg. Chem.* **148** (1925) 345–350.
2. J. H. De Boer, J. D. Fast, *Z. Anorg. Allg. Chem.* **153** (1926) 18.
3. W. J. Kroll, *J. Franklin Inst.* **260** (1955) 169–192.
4. O. Botstein, A. Rabinkin, M. Talianker, *Scr. Metall.* **15** (1981) 151–155.
5. T. L. Yau in C. S. Young, J. C. Durham (eds): *Industrial Applications of Titanium and Zirconium: Fourth Conference STP 917*, American Society for Testing and Materials, Philadelphia 1986, pp. 57–68.
6. T. L. Yau, R. T. Webster in: *Metals Handbook*, 9th ed., vol. 13, Corrosion, ASM International, Metals Park, OH, 1987, pp. 707–721.
7. B. Mason: *Principles of Geochemistry*, 3rd ed., Wiley & Sons, New York 1966, p. 45.
8. H. L. Gilbert, C. Q. Morrison, A. Jones, A. W. Henderson, *Bur. Mines Invest.* **5091** (1954).
9. H. S. Choi, *Can. Min. Metall. Bull. Trans.* **67** (1965) 65–70.
10. P. H. Wilks, *Chem. Eng. Prog.* **68** (1974).
11. Kawecki Chemical, US 2653855, 1953 (H. C. Kawecki).
12. A. J. Hudson, A. C. Haskell, Jr., *Electr. Furn. Conf. Proc.* **1958**, 211–220.
13. G. von Hevesy, *Chem. Rev.* **2** (1925) 1.
14. N. P. Sajin, E. A. Pepelyaeva, *Proc. Int. Conf. Peaceful Uses At. Energy*, 8th **1956**, 559–562.
15. J. M. Googin in F. R. Bruce, J. M. Fletcher, H. H. Hyman (eds.): *Progress in Nuclear Energy Series 3*, Process Chemistry, vol. 2, Pergamon Press, Oxford 1958, pp. 194–209.
16. R. H. Nielsen, R. L. Govro, *Bur. Mines Invest.* **5214** (1956).
17. N. P. H. Padmanabhan, T. Sreenivas, N. K. Rao, *High Temp. Muter. Process* **9** (1990) no. 2–4, 217–247.
18. L. Moulin, P. Thouvenin, P. Brun in D. G. Franklin, R. B. Adamson (eds.): "Zirconium in the Nuclear Industry: Sixth International Symposium", *ASTM Spec. Tech. Publ.* **824** (1984) 37–44.
19. J. A. Megy, H. Freun, *Metall. Trans. B* **10B** (1979) 413–421.
20. F. W. Starratt, *J. Met.* **II** (1959) 441–443.
21. A. P. Lamaze, D. Charquet in K. C. Liddell, D. R. Sadoway, R. G. Bautista (eds.): *Refractory Metals: Extraction, Processing and Applications*, The Minerals, Metals & Materials Society, Warrendale, PA, 1990 pp. 231–253.
22. S. N. Flengas, G. J. Kipouros, P. Tumidajski, *Met. Mater. Processes* **2** (1990) no. 3, 151–177.
23. Z. M. Shapiro in B. Lustman, F. Kerze, Jr. (eds.): *The Metallurgy of Zirconium*, McGraw-Hill, New York 1955, pp. 135–215.
24. R. F. Rolston: *Iodide Metals and Metal Iodides*, The Electrochemical Society, New York 1961.

25. ASTM Specification B614: Descaling and Cleaning Zirconium and Zirconium Alloy Surfaces.
26. T. L. Yau in R. T. Webster, C. S. Young (eds.): "Industrial Application of Titanium and Zirconium: Third Conference", *ASTM Spec. Tech. Publ.* **830** (1984) 124.
27. J. H. Schemel: "ASTM Manual on Zirconium and Hafnium", *ASTM Spec. Tech. Publ.* (1977).
28. R. I. Jaffee in Z. M. Shapiro in B. Lustman, F. Kerze, Jr. (eds.): *The Metallurgy of Zirconium*, McGraw-Hill, New York 1955, pp. 26-29.
29. D. A. Lorimer, E. J. Baker, M. Succi, D. K. Weber, *Solid State Technol.* **33** (1990) 77-79.
30. A. Clearfield, *Rev. Pure Appl. Chem.* **14** (1964) 91-108.
31. J. A. Speer in P. A. Ribbe (ed.): *Orthosilicates*, 2nd ed., Mineralogical Society of America, Washington DC, 1982.
32. R. C. Garvie, R. H. Hannink, R. T. Pascoe, *Nature (London)* **258** (1975) 703-704.
33. R. C. Garvie in A. E. Alper (ed.): *High Temperature Oxides*, part II, Academic Press, New York 1970, pp. 117-166.
34. A. H. Heuer, L. W. Hobbs (eds.): *Science and Technology of Zirconia*, American Ceramic Society, Columbus, OH, 1981.
35. N. Claussen, M. Rühle, A. H. Heuer (eds.): *Science and Technology of Zirconia II*, American Ceramic Society, Columbus, OH, 1984.
36. S. Somiya, N. Yamamoto, H. Yanagida (eds.): *Science and Technology of Zirconia III*, American Ceramic Society, Westerville, OH, 1988.
37. S. Meriani, C. Palmonari (eds.): *Zirconia '88 - Advances in Zirconia Science and Technology V*, Elsevier Appl. Sci., London 1989.
38. S. P. S. Badwal, M. J. Bannister, R. H. J. Hannink (eds.): *Science and Technology V*, Technomic Publishing Co., Lancaster, PA, 1993.
39. R. Stevens: *Zirconia and Zirconia Ceramics*, 2nd ed., Magnesium Elektron, Manchester, UK, 1986.
40. A. Pissenberger, G. Gritzner, *J. Mater. Sci. Lett.* **14** (1995) 1580-1582.
41. G. Gritzner, C. Puchner, J. Dusza, *J. Eur. Ceram. Soc.* **15** (1995) 45-49.
42. Y. Sugizaki et al., *J. Phys. Soc. Japan* **54** (1985) 2543-2551.
43. R. J. Ackerman, E. G. Rauh, C. A. Alexander, *High Temp. Sci.* **7** (1975) 304-316.
44. J. F. Menckus, *J. Cryst. Growth* **128** (1993) 13-14.
45. G. H. Haertling, C. E. Land, *Am. Ceram. Soc. Bull.* **49** (1970) 411.
46. R. Srinivasan, B. H. Davis, *Catal. Lett.* **14** (1992) 165-170.
47. G. T. Mamott et al., *J. Mater. Sci.* **26** (1991) 4054-4061.
48. M. Henry, J. P. Jolivet, J. Livage, *Struct. Bonding (Berlin)* **77** (1992) 153-206.
49. R. C. Garvie, *J. Phys. Chem.* **69** (1968) 1238-1243.
50. Société européenne des produits réfractaires, US 5149510, 1992 (J. Recasens, D. Urffer, P. Ferlanda).
51. W. W. Stephens, H. L. Gilbert, *J. Met.* **194** (1952) 733-737.
52. Electro Metallurgical Co., US 2433253, 1948 (W. J. Kroll, F. E. Bacon).
53. B. Krebs, *Angew. Chem. Int. Ed. Engl.* **8** (1969) 146-147.
54. M. Ohashi, S. Yamaoka, Y. Morimoto, M. Hattori, *Bull. Chem. Soc. Jpn.* **60** (1987) 2387-2390.
55. S. N. Flengas, P. Pint, *Can. Met.* **8** (1969) 151-166.
56. A. W. Strauss, J. D. Corbett, *Inorg. Chem.* **9** (1970) 1373-1376.
57. D. G. Adolphson, J. D. Corbett, *Inorg. Chem.* **15** (1976) 1820-1823.
58. J. D. Corbett, *Pure Appl. Chem.* **56** (1984) 1527-1543.
59. H. S. Marek, J. D. Corbett, R. L. Daake, *J. Less Common Metals* **89** (1983) 243-249.
60. A. Clearfield, P. A. Vaughan, *Acta Crystallogr.* **9** (1956) 555-558.
61. K. I. Arsenin, L. A. Malinko, I. A. Sheka, I. Ya Pishcai, *Russ. J. Inorg. Chem. (Engl. Transl.)* **35** (1990) 1327-1331.
62. M. D. Atherton, H. Sutcliffe, *J. Less Common Met.* **138** (1988) 63-70.
63. Teledyne, WO 94/12435, 1993 (J. A. Sommers).
64. L. M. Seaverson, J. D. Corbett, *Inorg. Chem.* **22** (1983) 3202-3210.
65. K. Dehnicke, J. Weidlein, *Angew. Chem. Int. Ed. Engl.* **5** (1966) 1041.
66. R. L. Daake, J. D. Corbett, *Inorg. Chem.* **16** (1977) 2029-2033.
67. E. M. Larsen, J. S. Wrazel, L. G. Hoard, *Inorg. Chem.* **21** (1982) 2619-2624.
68. D. H. Guthrie, J. D. Corbett, *Inorg. Chem.* **21** (1982) 3290-3295.
69. Teledyne, WO 89/1087, 1989 (J. A. Sommers).
70. M. Robinson, K. C. Fuller, *Mater. Res. Bull.* **22** (1987) 1725-1732.
71. W. J. S. Craigen, E. G. Joe, G. M. Ritchey, *Can. Met. Q.* **9** (1970) 485-492.
72. National Lead, US 2525474, 1950 (W. B. Blumenthal).
73. ICI Australia, WO 86/06362, 1986 (K. Ngian, A. J. Hartshoren, D. H. Jenkins).
74. I. J. Bear, W. G. Mumme, *Rev. Pure Appl. Chem.* **21** (1971) 189-211.
75. P. J. Squatrito, P. R. Rudolf, A. Clearfield, *Inorg. Chem.* **25** (1987) 4240-4244.
76. Hopton Technologies, US 5472485, 1995 (V. E. Pandian, C. V. Calcar, R. W. Wolff).
77. Nalco Chemical, US 5230774, 1993 (C. S. Greer, N. P. James).
78. T. B. Massalski (ed.): *Binary Alloy Phase Diagrams*, 2nd ed., ASM International, Materials Park, OH, 1990, pp. 2078-2080.
79. W. M. Mueller, J. P. Blackledge, G. G. Libowitz: *Metal Hydrides*, Academic Press, New York 1968, pp. 241-321.
80. J. Rexer, D. T. Peterson in: *Nuclear Metallurgy, International Symposium on Compounds of Interest in Nuclear Reactor Technology*, vol. X, AIME, New York 1964, p. 327.
81. A. W. Struss, J. P. Corbett, *Inorg. Chem.* **16** (1977) 360.
82. R. V. Sara, *J. Am. Ceram. Soc.* **48** (1965) 243-247.
83. E. Rudy: *Compendium of Phase Diagram Data*, Air Force Materials Laboratory, Wright-Patterson Air Force Base, OH, 1969.
84. Norton Co., US 3161470, 1958 (J. J. Scott).

85. T. Ogawa, *J. Alloys and Compounds* **203** (1994) 221-227.
86. W. E. Wang, D. R. Olander, *J. Alloys and Compounds* **224** (1995) 153-158.
87. M. A. Eronyan, R. G. Avarbe, *Inorg. Mater. (Engl. Transl.)* **10** (1974) 1850.
88. E. G. Gillan, R. B. Kaner, *Inorg. Chem.* **33** (1994) 5693-5700.
89. B. O. Johansson, H. T. G. Hentzell, J. M. E. Harper, J. J. Cuomo, *J. Mater. Res.* **1** (1986) 442-451.
90. R. Juza, A. Rabenau, I. Nitschke, *Z. Anorg. Allgem. Chem.* **332** (1964) 1-4.
91. R. Fix, R. G. Gordon, D. M. Hoffman, *Chem. Mater.* **3** (1991) 1138-1148.
92. J. C. McMullen, W. D. McKee, Jr., *Am. Ceram. Soc. Bull.* **44** (1965) 448-491.
93. B. D. James, B. E. Smith, *Synth. React. Inorg. Met. Org. Chem.* **4** (1974) 461-465.
94. L. A. Petrova, A. P. Borisov, V. D. Makhaev, *Sov. J. Coord. Chem. (Engl. Transl.)* **18** (1992) 425-428.
95. A. Clearfield, R. H. Blessing, *J. Inorg. Nucl. Chem.* **36** (1974) 1174-1176.
96. L. L. Y. Chang, M. G. Scroger, B. Phillips, *J. Am. Ceram. Soc.* **50** (1967) 211-215.
97. T. A. Mary et al., *Science* **272** (1996) 90-92.
98. A. Clearfield, J. A. Stynes, *J. Inorg. Nucl. Chem.* **26** (1964) 117-129.
99. U. Costantino in A. Clearfield (ed.): *Inorganic Ion Exchange Materials*, CRC Press, Boca Raton 1982.
100. Y. Watanabe, Y. Matsumura, Y. Izumi, Y. Mizutani, *Bull. Chem. Soc. Jpn.* **47** (1974) 2922-2925.
101. R. Sacks, Y. Avigal, E. Banks, *J. Electrochem. Soc.* **129** (1982) 726-729.
102. J. Alamo, R. Roy, *J. Am. Ceram. Soc.* **67** (1984) C78-82.
103. V. Korthuis et al., *Chem. Mater.* **7** (1995) 412-417.
104. W. B. Blumenthal: *The Chemical Behavior of Zirconium*, D. Van Nostrand, Princeton, 1958, p. 286.
105. W. B. Blumenthal in [104], p. 319.
106. D. C. Bradley, R. C. Mehrota, D. P. Gaur: *Metal Alkoxides*, Academic Press, London 1978, pp. 10-41.
107. R. B. Hahn, E. S. Baginski, *Anal. Chim. Acta* **14** (1965) 45-47.
108. R. Brayer, R. O'Connell, A. Powell, R. H. Gale, *Appl. Spectrosc.* **15** (1961) 10-13.
109. G. L. Beck, O. T. Farmer, *J. Anal. Spectrom.* **3** (1988) 771-773.
110. G. L. Beck, J. P. Fraley, Teledyne Wah Chang procedure ASP-OES-1 Rev. 0, 1988.
111. J. Schlewitz, M. Shields, *At. Absorpt. Newsl.* **10** (1971) 39-43.
112. R. VanSanten, J. Schlewitz, G. Beck, R. Walsh in F. D. Snell, L. S. Ettre (eds.): *Encyclopedia of Industrial Chemical Analysis*, vol. 14, Wiley-Interscience, New York 1971, pp. 103-148.
113. R. K. McGeary in: *Zirconium Alloys*, American Society for Metals, Cleveland 1953, pp. 168-175.
114. W. G. Guldner, *Talanta* **8** (1961) 191-202.
115. W. G. Smiley, *Anal. Chem.* **27** (1955) 1098-1102.
116. P. Ebling, G. W. Howard, *Anal. Chem.* **32** (1960) 1610-1613.
117. J. Surak, D. Fisher, C. Burros, L. Bate, *Anal. Chem.* **32** (1960) 117-119.
118. J. Lingane, *Anal. Chem.* **39** (1967) 881.
119. T. Barter et al., *Arch. Intern. Med.* **151** (1991) 1197-1201.
120. M. Y. Longley et al.: *A Toxic Hazard Study of Selected Missile Propellants*, Technical Documentary Report no. ARML-TDR-64-28 Biomedical Lab., Aerospace Med. Res. Lab. Wright-Patterson Air Force Base, OH, 1964.
121. I. T. Brakhova: *Environmental Hazards of Metals. Toxicity of Powdered Metals and Compounds*, translated from the Russian (original publ. 1971) by S. L. Slep, Consultants Bureau, New York, NY, 1975.
122. I. T. Brakhova, G. A. Shkupko, *Gig. Sanit.* **37** (1972) 36-39.
123. J. T. Prior, G. A. Cronk, D. D. Ziegler, *Arch. Environ. Health* **1** (1960) 297-300.
124. "Aerosol Drug and Cosmetic Products Containing Zirconium. Proposed Determination", *Fed. Regist.* **40** (1975) 24327-24344.
125. W. B. Shelley, H. J. Jurley, Jr., in M. Sauter (ed.): *Immunological Diseases*, 2nd ed., Little, Brown & Co., Boston 1971, pp. 722-734.
126. I. C. Smith, B. L. Carson: *Trace Metals in the Environment*, vol. 3, Zirconium, Ann Arbor Science Publ., Ann Arbor 1978, pp. 173-371.
127. U.S. Registry of Toxic Effects of Chemical Substances.

# 31 Hafnium

RALPH H. NIELSEN

31.1 Introduction .....	1459	31.10 Uses.....	1466
31.2 Physical Properties.....	1459	31.11 Economic Aspects.....	1466
31.3 Chemical Properties.....	1459	31.12 Compounds.....	1466
31.4 Occurrence and Raw Materials.....	1460	31.12.1 Borides and Borates.....	1467
31.5 Production.....	1460	31.12.2 Carbide.....	1467
31.5.1 Opening-up of Ore.....	1460	31.12.3 Halides.....	1467
31.5.2 Separation of Zirconium.....	1462	31.12.4 Hydride.....	1468
31.5.3 Recovery of Metallic Hafnium.....	1463	31.12.5 Nitride.....	1468
31.5.4 Refining.....	1464	31.12.6 Dioxide.....	1468
31.6 Environmental Protection.....	1464	31.12.7 Other Derivatives.....	1468
31.7 Quality Specifications.....	1465	31.13 Toxicology and Occupational Health.....	1469
31.8 Analysis.....	1465	31.14 References.....	1469
31.9 Storage and Transportation.....	1465		

## 31.1 Introduction

The element hafnium, is always found in zirconium ore and is available as a by-product of the production of zirconium metal. The average concentration of hafnium in the earth's crust is estimated at 2.8–4.5 ppm. Six isotopes occur naturally:  $^{174}\text{Hf}$  (0.16%),  $^{176}\text{Hf}$  (5.2%),  $^{177}\text{Hf}$  (18.6%),  $^{178}\text{Hf}$  (27.1%),  $^{179}\text{Hf}$  (13.7%), and  $^{180}\text{Hf}$  (35.2%). Hafnium is used principally as a minor alloying element in nickel-based superalloys and as a thermal neutron absorber in nuclear power reactors. Annual world consumption is about 50 t.

<i>mp</i>	2227 °C
<i>bp</i>	4602 °C
Density	13.31 g/cm <sup>3</sup>
Thermal conductivity (25 °C)	23.0 Wm <sup>-1</sup> K <sup>-1</sup>
Coefficient of linear expansion (0–1000 °C)	5.9 × 10 <sup>-6</sup> K <sup>-1</sup>
Specific heat (25 °C)	117 Jkg <sup>-1</sup> K <sup>-1</sup>
Vapor pressure (1767 °C)	10 <sup>-3</sup> Pa
(2007 °C)	10 <sup>-4</sup>
Electrical resistivity (25 °C)	3.51 × 10 <sup>-7</sup> Wm
Thermal neutron absorption cross section	1.04 × 10 <sup>-26</sup> m <sup>2</sup>
Crystal structure	
α-form	hexagonal close-packed (hcp)
β-form	body-centered cubic (bcc)
Temperature of α–β transformation	1760 °C

## 31.2 Physical Properties

Hafnium is a heavy, hard, ductile metal similar in appearance to stainless steel. Although chemically very similar to zirconium, it has several physical differences: hafnium has twice the density of zirconium, a higher phase transition temperature, and a higher melting point. Hafnium also has a high thermal neutron absorption coefficient (1.04 × 10<sup>-26</sup> m<sup>2</sup>), whereas that for zirconium is very low (1.8 × 10<sup>-29</sup> m<sup>2</sup>). Some physical properties of hafnium are listed below:

## 31.3 Chemical Properties

The ionic radii of hafnium and zirconium are almost identical because of the lanthanide contraction. Both elements exhibit a valence of four. Therefore, the chemistry of hafnium is similar to that of zirconium, and the elements are always found together in nature (see also Chapter 30).

Elemental hafnium reacts with hydrogen (> 250 °C), carbon (> 500 °C), and nitrogen (> 900 °C) to form brittle, nonstoichiometric interstitial compounds with metal-like conduc-



tivity. In molten salts, hafnium is normally quadrivalent, but in anhydrous molten halide salts, it can be reduced to hafnium(III) and hafnium(II).

In aqueous solution, hafnium is always quadrivalent, with a high coordination number (6, 7, or 8). In dilute acid, hafnium slowly hydrolyzes and polymerizes. Hafnium hydrous oxide precipitates from aqueous solution at ca. pH 2. The only inorganic compounds with significant solubility in neutral or slightly basic aqueous solution are the ammonium-hafnium carbonate and potassium-hafnium carbonate complexes. The tendency for hafnium to form inorganic complexes with anions decreases in the following order:  $\text{OH}^- > \text{F}^- > \text{PO}_4^{3-} > \text{CO}_3^{2-} > \text{SO}_4^{2-} > \text{NO}_3^- \approx \text{Cl}^- > \text{ClO}_4^-$ .

Reviews of zirconium chemistry [1, 2] are frequently useful for indications of the chemical behavior of hafnium, because of the similarity in chemical properties.

### 31.4 Occurrence and Raw Materials

Mineralogically, hafnium is always found with zirconium. Although about 40 known minerals contain these elements, the main commercial sources of zirconium and hafnium are *zircon* and *baddeleyite*, since they are available as by-products in the recovery of other minerals. Zircon sand is obtained during the processing of alluvial heavy mineral sands to recover the titanium minerals rutile and ilmenite. Commercially recoverable deposits of these heavy mineral sands are found in China, Malaysia, Thailand, India, Sri Lanka, Australia, South Africa, Madagascar, and the United States. Clean (high quality) zircon contains 64% zirconium oxide, 34% silicon dioxide, 1.2% hafnium dioxide, with the balance including aluminum, iron, phosphorus, rare earths, titanium, uranium, and thorium.

Worldwide, the hafnium content of zircon is usually ca. 2% of the zirconium content. A notable exception is a Nigerian zircon, available in commercial quantities during 1957–1965, that contained 6% hafnium (based on

zirconium). Two minerals, a Norwegian thortveitite and a Mozambican hafnon, have been reported to contain more hafnium than zirconium. Baddeleyite usually contains hafnium at < 2% of the zirconium content. At the Phalaborwa complex in South Africa, baddeleyite is recovered from process tailings in the extraction of copper and the extraction of apatite for phosphate fertilizers.

Although hafnium reserves are significant, demand is low and easily met as a by-product of the production of reactor-grade zirconium. Known hafnium reserves are listed in Table 31.1.

Table 31.1: Known hafnium reserves,  $\times 10^3$  t.

Country	Annual zircon production	Zircon reserve <sup>a</sup>	Hf content of zircon reserve
Australia	480	32 000	390
United States	135	15 000	145
South Africa	135	15 000	145
Brazil	18	4000	38
India	15	9000	85
Sri Lanka	5	3000	29
Malaysia	3	3000	29

<sup>a</sup>Estimated.

### 31.5 Production

Processing steps and alternative processes for the production of hafnium metal from zircon sand are shown in Figure 31.1.

#### 31.5.1 Opening-up of Ore

Zircon is a refractory mineral, whose decomposition requires the use of aggressive chemicals and high temperature. Today, the commonly used techniques are caustic fusion, direct carbochlorination, or thermal dissociation; however, other procedures such as fusion with dolomite, fusion with potassium hexafluorosilicate, and a two-step process involving carbiding and exothermic chlorination of the crude carbide have all been used extensively to obtain zirconium and hafnium in more chemically active form.

The caustic fusion of zircon by using a slight excess of sodium hydroxide at 600 °C is the most common process for opening-up of zircon ore [3]:

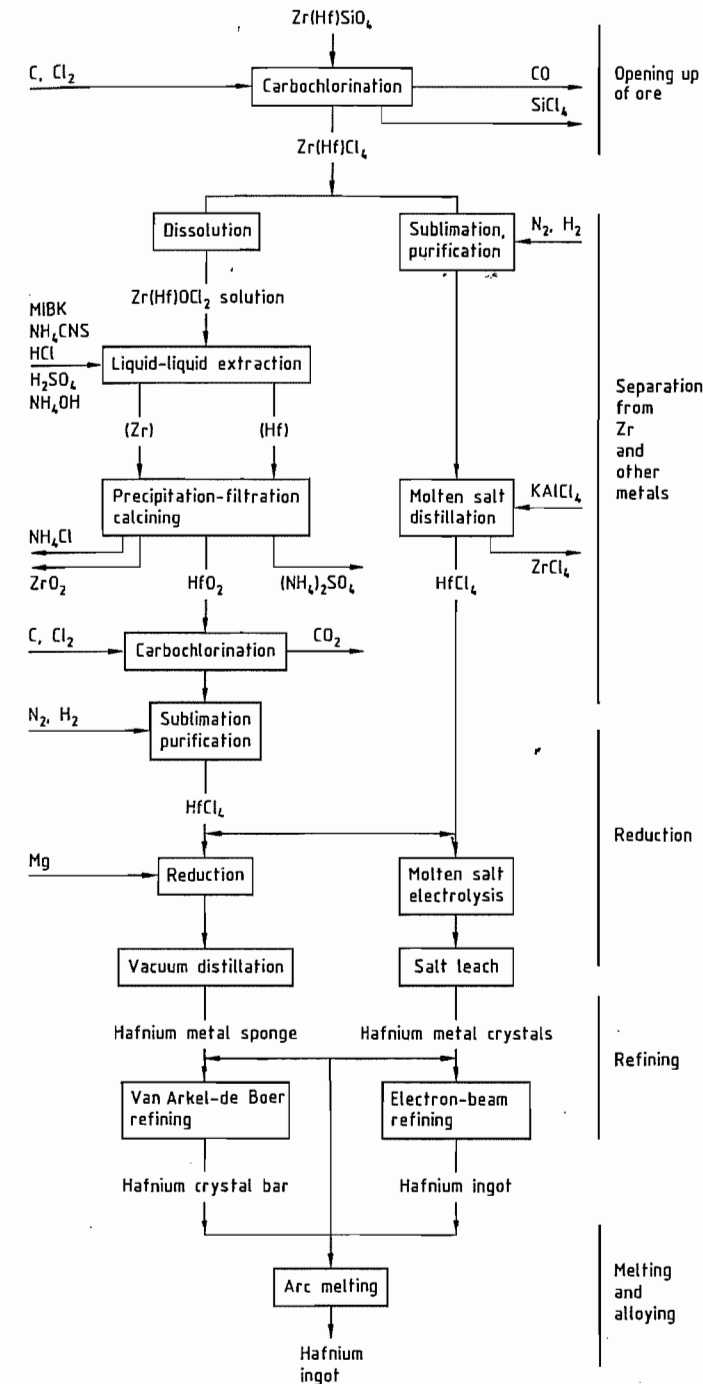
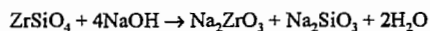

Figure 31.1: Flow diagram for production of hafnium.



The cooled reaction mass is broken up and slurried in water, which dissolves sodium silicate and hydrolyzes sodium zirconate to soluble sodium hydroxide and insoluble hydrous zirconia; the latter is recovered by filtering the slurry. Hydrous zirconia is soluble in strong mineral acid; hafnium can be recovered from the primary zirconium stream by ion exchange or liquid-liquid extraction.

Variations of this fusion process involve the use of sodium carbonate at 900 °C or the use of only half the quantity of sodium hydroxide to produce sodium zirconium silicate; the latter is subsequently treated with acid to form a soluble zirconium compound. These fusion processes are used worldwide to produce zirconium oxide, aqueous solutions of zirconium, and water-soluble zirconium compounds.

Fluidized-bed carbochlorination of zircon sand is the ore-decomposition process used by all three hafnium producers in the Western hemisphere: Teledyne Wah Chang Albany, CEZUS Division of Pechiney, and Western Zirconium Division of Westinghouse:

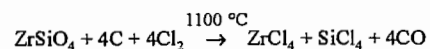

All the reaction products are gases when they leave the chlorinator. Zirconium and hafnium tetrachlorides are recovered as a powder by cooling the gas mixture to 200 °C in a large-volume space condenser. Silicon tetrachloride is then condensed by direct countercurrent contact of the remaining gas mixture with refrigerated (-40 °C) recycled liquid silicon tetrachloride.

Thermal dissociation of zircon in the high temperature of a plasma torch followed by rapid quenching is used to produce intimately mixed crystals of zirconium and silicon oxides. The oxides can be leached countercurrently with sodium hydroxide to yield zirconium oxide and a solution of sodium silicate, or leached with hot strong sulfuric acid to give a zirconium sulfate solution and silica. Both procedures are used by the Z-Tech Corporation Division of ICI.

### 31.5.2 Separation of Zirconium

Many well-known methods exist for separating hafnium from zirconium: ion exchange with a dilute sulfuric acid eluent [4]; *liquid-liquid extraction* of hafnium from hydrochloric acid solution by a methyl isobutyl ketone thiocyanic acid solution [5-8]; *distillation* of the mixed binary tetrachlorides at a pressure above the triple point [9]; and *extractive distillation* of hafnium tetrachloride from the mixed tetrachlorides dissolved in a molten halide solvent [10, 11].

**Ion exchange** is the easiest laboratory procedure. A dilute solution of  $\text{Zr}(\text{Hf})\text{OCl}_2$  is introduced into a bed of strong cation-exchange resin and eluted with 0.25 M sulfuric acid. The eluate contains three components: (1) a small amount of unseparated metal, apparently polymerized, with minimum retention time; (2) a major fraction containing zirconium; and (3) a smaller fraction containing hafnium. A continuously fed rotating cylindrical bed system has been proposed for commercial separation of hafnium and zirconium [4].

**Liquid-Liquid Extraction.** The methyl isobutyl ketone (MIBK) liquid-liquid extraction is based on an analytical method for determining hafnium [12]. The process was developed at Oak Ridge National Laboratory to obtain hafnium-free zirconium to contain uranium fuel for nuclear-powered submarines. Recovery of hafnium as a by-product was initiated when uses were found for the hafnium.

The zirconium-hafnium dichloride oxide solution is introduced at the midpoint of a series of countercurrent contact stages in which the organic solvent is MIBK containing thiocyanic acid and the countercurrent aqueous solution is dilute hydrochloric acid. Hafnium is extracted preferentially into the organic solution as a hafnium oxide thiocyanate complex. The separation factor per stage is 4-5. After extraction, hafnium is recovered by treating the organic phase with dilute sulfuric acid, the water-soluble hafnium sulfate being more stable than the thiocyanate complex. The sulfuric acid is then neutralized to precipitate

hydrous hafnium oxide, which is calcined to hafnium oxide. This procedure is used by both U.S. producers of hafnium.

**Fractional Distillation.** Separation by fractional distillation would be feasible if the tetrachlorides could be handled as liquids; however, the tetrachlorides are solid or gaseous unless kept under pressure while heated to the triple point of zirconium tetrachloride (435 °C, 2.0 MPa). The operating range of a binary distillation system is limited because the critical temperature for zirconium tetrachloride is ca. 505 °C.

**Extractive distillation** of the mixed tetrachlorides from molten potassium chloroaluminate at atmospheric pressure was developed and used commercially by CEZUS [10, 11]. The crude tetrachloride product from carbochlorination is first purified by sublimation in an atmosphere of nitrogen with 1-5% hydrogen. The purified tetrachloride is then reevaporized, and the vapor is introduced continuously above the midpoint of the distillation column. The potassium chloroaluminate solvent, equilibrated with hafnium-rich tetrachloride, is fed into the top of the distillation column, which is maintained at 350 °C. As the solvent cascades down the column it is gradually depleted of the more volatile hafnium tetrachloride, so that zirconium tetrachloride in the solvent reaching the bottom of the column contains < 50 ppm of the hafnium compound. The separation factor per stage is 1.4.

The solvent is fed to a boiler where much of the zirconium tetrachloride is vaporized and passed back up the column to become enriched in hafnium. Solvent from the boiler is fed into a stripper where it is treated with nitrogen to remove the remaining zirconium tetrachloride.

The stripped solvent is pumped to an absorber-condenser above the column where the solvent is equilibrated with the hafnium-rich tetrachloride and returned to the top of the distillation column. Unabsorbed hafnium-rich tetrachloride vapor ( $\text{HfCl}_4$  content 30-50%) is collected in the hafnium condenser. This hafnium-enriched tetrachloride accumulates

until it can be reprocessed in the distillation column under different conditions to produce pure hafnium tetrachloride (< 1%  $\text{ZrCl}_4$ ).

The degree of separation attained by these various processes is limited only by the number of stages provided in the separation equipment. Zirconium containing < 20 ppm hafnium and hafnium containing < 50 ppm zirconium have been produced.

### 31.5.3 Recovery of Metallic Hafnium

Hafnium dioxide from the separation process is converted first into hafnium tetrachloride by fluidized-bed carbochlorination:

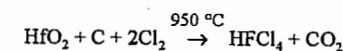

The recovered hafnium tetrachloride is purified by sublimation in a nitrogen hydrogen atmosphere to reduce the levels of aluminum, iron, and uranium.

**Kroll Process.** Hafnium tetrachloride powder is placed in a vertical cylindrical steel retort welded onto a stainless steel-lined steel crucible containing cast ingots of magnesium. The two chambers are connected by a pipe rising through the center of the hafnium tetrachloride charge. The assembled retort is sealed, evacuated, and filled with argon several times to remove traces of air. The retort is lowered into a furnace; the lower section is then heated to 850 °C. Molten magnesium reduces the hafnium tetrachloride vapor as it sublimates out of the upper chamber. After the reaction is complete, the lower crucible contains hafnium metal, magnesium chloride, and excess magnesium. The retort is cooled and unloaded. The stainless steel liner is separated from the reduction mass, and the upper layer of magnesium chloride is physically removed from the hafnium magnesium metallic regulus. The latter is loaded into a vacuum distillation furnace for removal of magnesium and residual magnesium chloride. As the temperature gradually increases, magnesium sublimates, leaving a skeletal structure of hafnium sponge. Magnesium chloride melts and drains into the cool

lower portion of the retort. After the furnace is cooled and the sponge conditioned by slow, controlled exposure to air, the sponge is removed and placed in an argon atmosphere, where it is broken and chopped into pieces finer than 20 mm.

**Electrowinning.** Electrowinning of hafnium and zirconium has long been investigated as an alternative to metallothermic reduction. CEZUS recently began production of hafnium by electrolysis of hafnium tetrachloride dissolved in a molten equimolar bath of potassium and sodium chlorides [13]. Hafnium tetrachloride vapor is introduced periodically below the liquid level of the bath to replenish hafnium. The bath contains just enough sodium fluoride to convert dissolved hafnium into the hexafluorohafnate complex.

### 31.5.4 Refining

Applications of metallic hafnium require lower oxygen levels than commonly achieved by the Kroll process. Purification is accomplished by the *Van Arkel-de Boer* process, also known as the iodide-bar or crystal-bar process [14, 15]. Hafnium sponge is treated with iodine vapor to form volatile hafnium iodide, which diffuses to an electrically heated hafnium filament. Hafnium iodide dissociates at the filament temperature of 1400 °C, depositing hafnium on the filament and releasing iodine to repeat the diffusion cycle. The hafnium filament slowly grows from a 3-mm wire to a 40-mm crystal-faceted bar. Purification is effective in leaving behind interstitial impurities such as oxygen, carbon, and nitrogen. Metallic impurities generally transport poorly, depending on the behavior of individual iodides, so the hafnium filament is much purer than the sponge.

*Electron beam melting* can also be used to purify hafnium. Hafnium is slowly drip-melted into a superheated molten pool under extremely high vacuum. The more volatile metallic impurities and suboxides are boiled off at a much faster rate, relative to the vaporization of hafnium. Two slow melts are standard for hafnium.

**Table 31.2:** Typical impurity levels for hafnium metal, ppm.

	Kroll process sponge	Electrowon crystals	Electron-beam melting ingot	Van Arkel-de Boer crystal bar
Oxygen	875	670	320	<50
Nitrogen	35	15	40	<5
Carbon	<30	40	<30	<30
Chlorine	100	50	<5	<5
Aluminum	200	10	<25	<25
Chromium	40	30	<20	<20
Iron	530	100	<50	<50
Magnesium	440	<10	<10	<10
Manganese	15	10	<10	<10
Nickel	<25	40	<25	<25
Silicon	25	<25	<25	<25
Titanium	<25	30	<25	<25

Typical impurity levels for Kroll-process hafnium sponge and electrowon hafnium crystals are shown in Table 31.2, together with the effectiveness of refining sponge by electron-beam melting or the Van Arkel-de Boer process.

## 31.6 Environmental Protection

Zircon contains traces of uranium and thorium in solid solution substitutionally and isomorphically in its structure. The retention of these elements and their radioactive decay daughter products are so complete that geological dating of rocks can be conducted by determining the radiological age of the zircon. Conversely, when the zircon structure is destroyed chemically, uranium, thorium, and their daughter products are released. If the attack on zircon is similar to carbochlorination, in which both zirconia and silica are converted to volatile species, the reaction residue may have sufficient concentrations of less volatile radioactive materials for special disposal procedures to be necessary.

Recovery of hafnia and zirconia from the acid solutions of liquid-liquid extraction results in process streams containing ammonium sulfate and ammonium chloride. Ammonia must be recovered for recycling or sale to avoid a heavy biological oxygen demand on effluent-receiving streams. Extreme

care must be taken to ensure that hypochlorite scrubbing solutions from chlorination do not come in contact with effluent streams containing traces of thiocyanate because the mixture produces cyanides.

## 31.7 Quality Specifications

For wrought hafnium the following U.S. specifications apply: ASTM B737-84 for Hot-Rolled or Cold-Finished Rod and Wire; ASTM B776-87 for Hafnium and Hafnium Alloy Strip, Sheet, and Plate; ASTM G2-88 and G2M-88 for Corrosion Testing of Products of Zirconium, Hafnium, and Their Alloys in Water at 680 °F (360 °C, 633 K) or in Steam at 750 °F (400 °C, 673 K); and ASTM C1076-87 for Nuclear-Grade Hafnium Oxide Pellets.

In Germany, VdTUV Material Sheet 463, Hafnium, 05.83, covers wrought hafnium sheet.

Hafnium for alloying purposes is sold in chunk or particulate form, at the particular chemical purity specified by the customer; the zirconium content is particularly important.

## 31.8 Analysis

Hafnium is chemically so similar to zirconium that most gravimetric, volumetric, or colorimetric methods of analysis result in a combined hafnium-zirconium determination. Methods that do not require prior separation of hafnium include atomic absorption spectroscopy, emission spectroscopy, plasma emission spectroscopy, mass spectroscopy, X-ray spectroscopy, and neutron activation [16]. Ores and compounds are frequently analyzed by precipitating hafnium and zirconium with mandelic acid [17], igniting the precipitate to give the combined oxides, and determining the relative proportion of each oxide by X-ray or emission spectroscopy.

Many analytical methods for determining impurities in zirconium can also be applied to hafnium [16, 18]. Carbon and sulfur in hafnium are measured by combustion, followed by chromatographic or IR determina-

tion of the oxides [16]. Hydrogen is determined by thermal conductivity after hot-vacuum extraction or by fusion of hafnium with a transition metal in an inert atmosphere and subsequent separation by gas chromatography [19, 20].

Simultaneous determination of nitrogen and oxygen is accomplished by a technique similar to that for hydrogen [21, 22]. Nitrogen can also be determined by the Kjeldahl technique [16]. Phosphorus may be determined by visible spectrophotometry using molybdenum blue [16] but can be determined more rapidly by phosphine evolution and flame emission spectroscopy.

Chloride at low level is determined indirectly by precipitation with silver nitrate and determination of silver by X-ray or atomic absorption spectroscopy. Fluoride and higher levels of chloride can be measured by selective ion electrode techniques [23, 24].

Other impurities are usually determined by emission spectroscopy either arc spark [25, 26] or plasma excitation [27, 28]. Many impurities can be determined rapidly and inexpensively. Atomic absorption is frequently used to determine a variety of impurities in hafnium metal and sponge [29].

## 31.9 Storage and Transportation

Hafnium metal powder is a flammable solid and should be kept dry, cool, and separate from potential oxidants. Dry hafnium powder, chemically produced, finer than  $8.40 \times 10^{-4}$  m (840  $\mu$ m, 20 mesh), or mechanically produced, finer than  $5.3 \times 10^{-5}$  m (53  $\mu$ m, 270 mesh), must have the following warning labels for shipping:

UN no. 2545

United States DOT: Flammable Solid

IAIA Dangerous Goods Regulations: Combustible Solid

IMDG Code: Combustible Solid

The same hafnium powder, wet, containing at least 25% water, must be labeled as a flammable solid for all shipping and hazard communication purposes (UN no. 1326).

Hafnium powder of the above descriptions, wet or dry, is forbidden on U.S. passenger aircraft by DOT. Dry hafnium metal powder, mechanically produced, finer than  $3 \times 10^{-6}$  m, or chemically produced, finer than  $10 \times 10^{-6}$  m, is forbidden from all air transportation by IATA.

Although not specifically required, hafnium hydride or hafnium carbide powder should be labeled, handled, and stored in similar fashion.

Hafnium tetrachloride must be shipped as a corrosive solid (UN no. 1759).

### 31.10 Uses

The major uses of hafnium involve the metal. The largest use is as an alloying additive (1–2%) in nickel-based superalloys. These alloys are used in turbine vanes in the combustion zone of jet aircraft engines. Addition of hafnium to some present-generation alloys has raised the allowable service temperature by 50 °C, improving engine efficiency. Hafnium forms stable precipitates at grain boundaries, improving high-temperature creep strength.

The second major use of hafnium is as control-rod material in nuclear reactors. In early reactors, bare hafnium metal in long cruciform shape was used because of the excellent hot-water corrosion resistance, good ductility, and machinability of hafnium, as well as its high thermal neutron absorption cross section. Hafnium clad in stainless steel is now replacing stainless steel-clad silver–indium–cadmium and stainless steel-clad boron carbide in some commercial nuclear power plants.

Hafnium is also used as an alloying element in niobium, tantalum, titanium, molybdenum, and tungsten alloys, as well as some new nickel aluminides.

Hafnium and hafnium–zirconium alloys have been suggested for use in spent nuclear fuel storage racks, and for tanks and piping in spent fuel reprocessing plants because of the neutron absorption capability of hafnium and its resistance to nitric acid. For a while, shred-

ded hafnium foil was used instead of zirconium foil as fuel in some photographic flashbulbs because hafnium provided a higher intrinsic color temperature and a greater light output. Pure hafnium has also been used as the active tip for plasma arc cutting tools.

Hafnium carbide–niobium carbide solid solutions have been used as a replacement for tantalum carbide in steel-cutting grades of cemented carbide tool bits.

Hafnium oxide has been used as a specialized refractory, including thermocouple insulation for short-term use above 2000 °C. Hafnium and hafnium oxide sputtering targets are used for coatings and specialized electronic applications.

Hafnium tetrachloride has been used to prepare hafnium metallocene Ziegler–Natta-type catalysts, which were the first catalysts to provide high yields of high molecular mass isotactic polypropylene [30]. Hafnium tetrafluoride is used in some heavy-metal fluoride glass cladding [31].

### 31.11 Economic Aspects

Production of hafnium oxide and hafnium tetrachloride has been steady since 1980, as a result of the leveling off of zirconium metal production for the nuclear energy program. The availability of hafnium still exceeds market demand. Annual Western hemisphere availability is estimated at 80 t, with consumption estimated at 50 t. Hafnium is produced commercially in the United States (Teledyne Wah Chang Albany and Western Zirconium Division of Westinghouse), France (CEZUS Division of Pechiney), and the former Soviet Union.

In 1988, hafnium oxide was available at \$100/kg; hafnium crystal bar, at \$200/kg; and hafnium wrought metal products (plate, sheet, wire, foil), from \$250 to \$500/kg.

### 31.12 Compounds

Compounds of hafnium have been studied mostly to develop methods of separating

hafnium from zirconium, producing the metal, and comparing properties with similar zirconium compounds. Although the properties of inorganic hafnium and zirconium compounds are generally comparable, differences in chemical behavior become more evident in organometallic compounds.

#### 31.12.1 Borides and Borates

**Hafnium boride**,  $\text{HfB}_2$ , is prepared by carbon reduction of hafnium oxide and boron carbide, by coreduction of hafnium and boron chlorides with magnesium or hydrogen, or from the elements. It is of interest because it is very refractory. Hafnium dodecaboride,  $\text{HfB}_{12}$ , has been synthesized by compressing the elements at 1660 °C and  $6.5 \times 10^3$  MPa.

**Hafnium tetrahydroborate**,  $\text{Hf}(\text{BH}_4)_4$ , is prepared by reaction of hafnium tetrachloride with lithium borohydride in diethyl ether, followed by double sublimation under vacuum at 20 °C [32]. Hafnium tetrahydroborate is one of the most volatile hafnium compounds known: *mp* 29 °C, *bp* 118 °C, vapor pressure 2 kPa at 25 °C. Its decomposition at ca. 250 °C forms the basis for a low-temperature method of depositing amorphous hafnium diboride films [33].

#### 31.12.2 Carbide

Hafnium carbide,  $\text{HfC}$ , is usually produced by carbothermic reduction of hafnium oxide in an induction-heated graphite-lined vacuum furnace. Hafnium carbide film can be deposited by reaction of hafnium tetrachloride and methane in a hydrogen atmosphere at 900–1400 °C. Hafnium carbide is a nonstoichiometric interstitial carbide with carbon atoms at octahedral interstices of the hafnium metal lattice. The hafnium–carbon phase diagram shows that hafnium carbide is single phase within the range 39.5–49.5 atom% carbon at 1400 °C [34]. Hafnium carbide is a hard refractory material with metallic conductivity.

#### 31.12.3 Halides

Hafnium tetrafluoride,  $\text{HfF}_4$ , can be made by addition of a stoichiometric amount of hydrofluoric acid to hafnium oxide chloride dissolved in 8 M nitric acid, to precipitate hafnium tetrafluoride monohydrate. The filtered crystals are dried in a stream of anhydrous hydrogen fluoride gas. Alternatively, anhydrous hydrogen fluoride can undergo an exchange reaction with hafnium tetrachloride powder or vapor, or ammonium fluorohafnate can be heated to drive off ammonium fluoride, leaving hafnium tetrafluoride as residue.

Potassium hexafluorohafnate  $\text{K}_2\text{HfF}_6$ , can be crystallized from hafnium fluoride solution by adding a stoichiometric amount of potassium fluoride. The solution should be acidic to minimize hydrolysis. Other alkali metal hexafluorohafnates ( $\text{Na}_2\text{HfF}_6$ ,  $\text{Rb}_2\text{HfF}_6$ , and  $\text{Cs}_2\text{HfF}_6$ ) and the corresponding ammonium salts can be prepared similarly. With different proportions of alkali fluoride, other salts can be precipitated, including  $\text{MHfF}_5$ ,  $\text{M}_3\text{HfF}_7$ , and  $\text{M}_5\text{Hf}_2\text{F}_{13}$ .

Hafnium tetrachloride,  $\text{HfCl}_4$ , is prepared commercially by carbochlorination of hafnium oxide at 900 °C. Chlorination can be carried out with phosgene or carbon tetrachloride at 450 °C. Hafnium tetrachloride is used as starting material for the preparation of organic derivatives of hafnium, alkoxides, and alkali chlorohafnates. The partitioning of mixed tetrachloride vapor by alkali-metal salts, with preferential formation of alkali chlorohafnate and elimination of unreacted zirconium tetrachloride, has been proposed as a means of separating hafnium and zirconium [35, 36]. Hafnium tetrachloride vapor reacts with steam to form finely divided hafnium oxide. Solid hafnium tetrachloride reacts with water to form hafnium oxide chloride and hydrochloric acid.

Hafnium dichloride oxide,  $\text{HfOCl}_2$ , is soluble in water and can be crystallized from hydrochloric acid solution as the octahydrate,  $\text{HfOCl}_2 \cdot 8\text{H}_2\text{O}$ . The solubility of hafnium dichloride oxide increases significantly with temperature and decreases with increasing

acidity up to 8.5 M hydrochloric acid. This crystallization procedure is the preferred method for obtaining pure hafnium dichloride oxide prior to the preparation of other hydrated hafnium compounds. Hafnium dichloride oxide is converted to the hydrous oxide  $\text{HfO}_2 \cdot x\text{H}_2\text{O}$  on neutralization, at pH 2. On heating, hafnium dichloride oxide first loses water, then slowly releases water and hydrogen chloride, and is converted into granular hafnium oxide.

Hafnium tetrabromide,  $\text{HfBr}_4$ , and hafnium tetraiodide,  $\text{HfI}_4$ , are produced by reaction of the respective halogen with hafnium metal in the absence of air above 300 °C. Thermal dissociation of the tetraiodide is employed in the iodide-bar refining process.

Lower valence hafnium halides have been formed by reduction of tetrahalides with aluminum or hafnium in molten aluminum chloride or molten alkali halide baths. Zirconium is more easily reduced; this is the basis of several proposals for the separation of hafnium and zirconium [37, 38].

### 31.12.4 Hydride

Hafnium hydride,  $\text{HfH}_x$ , is formed as hafnium absorbs hydrogen. The proportion of hydrogen absorbed depends on temperature and hydrogen pressure. Above 500 °C, as hydrogen is absorbed, hafnium changes from hexagonal close-packed metal, to face-centered cubic hydride, and then to face-centered tetragonal hydride as the composition approaches the limiting solubility, with  $x = 2$  [39]. At room temperature, hafnium hydride exists as the face-centered cubic form when  $x = 1.7$ – $1.8$ , and as the face-centered tetragonal form when  $x \geq 1.87$ .

Hafnium hydride is brittle and easily crushed. Crushing must be conducted in an argon atmosphere to avoid ignition of the fine powder. Hydrogen absorption is reversible; the process of hydriding, crushing, and dehydriding is therefore used to convert hafnium metal pieces into powder with little contamination. Hydrogen is removed by heating the hydride under vacuum.

### 31.12.5 Nitride

Hafnium nitride,  $\text{HfN}$ , is a nonstoichiometric interstitial nitride, which is single phase within the range 42–50 atom% nitrogen [40]. Hafnium nitride film can be deposited by reacting hafnium tetrachloride vapor with ammonia or nitrogen in a hydrogen atmosphere above 1000 °C. Above 1400 °C, nitride powder is produced. This film deposition process is used to coat cemented carbide tool bits. Hafnium nitride film is more effective than titanium nitride in reducing frictional forces and wear when machining steel [41].

### 31.12.6 Dioxide

Hafnium dioxide, hafnia,  $\text{HfO}_2$ , is the only stable oxide of hafnium. It melts at 2900 °C and exists in three solid phases: a monoclinic phase stable up to 1475–1600 °C, above which hafnia changes into the tetragonal phase, the stable form up to ca. 2700 °C. Between 2700 and 2900 °C, hafnia has a cubic fluorite structure. Like zirconia, the tetragonal monoclinic transition is a martensitic transformation that exhibits considerable hysteresis. The cubic structure can be stabilized by addition of calcium oxide, yttrium oxide, or some of the rare-earth oxides, including those of cerium and europium. The use of stabilized hafnia for high-temperature engineered ceramics avoids the catastrophic 7% shrinkage that accompanies transformation from monoclinic to tetragonal form.

Hafnium dioxide is very stable and, except for strong hydrofluoric acid, is attacked only at elevated temperature. Hafnia reacts with carbon tetrachloride or phosgene above 400 °C, and with chlorine and carbon above 700 °C, to form hafnium tetrachloride. At high temperature, hafnia reacts with many metal oxides to form solid solution oxides or hafnate compounds such as  $\text{CaHfO}_3$ .

### 31.12.7 Other Derivatives

Several excellent publications that cover the preparation and properties of hafnium

alkoxides, hydrides, and organic derivatives are available [42–44].

## 31.13 Toxicology and Occupational Health

Hafnium metal with a high surface area, such as thin machining chips, powder, sponge, or grinding dust, is extremely flammable, even pyrophoric. If the metal is slightly wet (5–15%  $\text{H}_2\text{O}$ ) ignition can occur with explosive violence. Fires can be extinguished with a layer of dry salt or with a blanket of argon if the metal is in a container.

Water can be hazardous for fire fighting because it is a source of oxygen for the burning metal. The resulting hydrogen and steam may blow the burning chips throughout the area. Several reviews of methods for safe handling of hafnium and zirconium are available [45, 46].

Hafnium is essentially nontoxic. No health problems have been attributed to hafnium in more than 30 years of industrial experience with the metal and its compounds. Toxicological studies of ingestion indicate that the toxicities of hafnium and zirconium are similar. Hafnium was found to accumulate in the liver when hafnium compounds were injected intravenously or intraperitoneally into rats [47]. Chronic feeding of 1% hafnium tetrachloride to rats for 90 d caused liver damage [48]. The ACGIH TLV–TWA for hafnium is 0.5  $\text{mg}/\text{m}^3$ .

Hafnium tetrachloride and tetrabromide hydrolyze immediately on contact with water, releasing hydrochloric or hydrobromic acid fumes. These compounds should be handled with proper ventilation and personal protection.

## 31.14 References

1. A. Clearfield, *Rev. Pure Appl. Chem.* **14** (1964) 91.
2. R. Clark, D. Bradley, P. Thornton: *The Chemistry of Titanium, Zirconium, and Hafnium*, Pergamon Press, Oxford 1973.
3. H. S. Choi, *Can. Min. Metall. Bull.* **67** (1965) 65.
4. J. M. Begovich, W. G. Sisson, *Hydrometallurgy* **10** (1983) 11–20.
5. W. A. Stickney: "Zirconium–Hafnium Separation", USBM RI 5499, 1959.
6. J. M. Googin in F. R. Bruce, J. M. Fletcher, H. H. Hyman (eds.): *Progress in Nuclear Energy, Series III: Process Chemistry*, vol. 2. Pergamon Press, New York 1958.
7. J. H. McClain, S. M. Shelton in C. R. Tipton, Jr., (ed.): *Reactor Handbook*, vol. 1, Materials, 2nd ed., Interscience Publishers, New York 1960.
8. W. Fischer et al., *Angew. Chem. Int. Ed. Engl.* **5** (1966) 15–23.
9. E. I. DuPont de Nemours, US 2852446, 1956 (M. L. Bromberg).
10. Pechiney Ugine Kuhlman, US 4021531, 1976 (P. Besson, J. Guerin, P. Brun, M. Bakes).
11. L. Moulin, P. Thourvenin, P. Brun in D. G. Franklin (ed.): *Zirconium in the Nuclear Industry*, 6th Int. Symposium, ASTM STP 824, American Society for Testing and Materials, Philadelphia 1984, pp. 37–44.
12. W. Fischer, W. Chalybaeus, *Z. Anorg. Allg. Chem.* **255** (1948) 277.
13. Pechiney, US 4657643, 1986 (M. Armand, J.-P. Garnier).
14. E. M. Sherwood, I. E. Campbell in D. E. Thomas, E. T. Hayes (eds.): *The Metallurgy of Hafnium*, US Government Printing Office, Washington, DC, 1960, 108–118.
15. R. F. Rolston: *Iodide Metals and Metal Iodides*, The Electrochemistry Society, New York 1961.
16. R. VanSanten, J. Schlewitz, G. Beck, R. Walsh in F. D. Snell, L. S. Ettre (eds.): *Encyclopedia of Industrial Chemical Analysis*, vol. 14, Wiley-Interscience, New York 1971, pp. 103–148.
17. R. B. Hahn, E. S. Baginski, *Anal. Chim. Acta* **14** (1956) 45–47.
18. R. B. Hahn in I. M. Kolthoff, P. J. Elving, E. B. Sandell (eds.): *Treatise on Analytical Chemistry*, Part II, vol. 5, Interscience, New York 1961, pp. 61–138.
19. R. K. McGeary in *A Symposium on Zirconium and Zirconium Alloys*, American Society for Metals, Cleveland 1953, pp. 168–175.
20. W. G. Guldner, *Talanta* **8** (1961) 191–202.
21. W. G. Smiley, *Anal. Chem.* **27** (1955) 1098–1102.
22. P. Elbling, G. W. Goward, *Anal. Chem.* **32** (1960) 1610–1613.
23. J. Surak, D. Fisher, C. Burros, L. Bate, *Anal. Chem.* **32** (1960) 117–119.
24. J. Lingane, *Anal. Chem.* **39** (1967) 881.
25. L. Carpenter, J. M. Nishi: "Analysis of High-Purity Columbium by Optical Emission Spectrography", USBM RI 6384, 1964.
26. R. Brayer, R. O'Connell, A. Powell, R. H. Gale, *Appl. Spectrosc.* **15** (1961) 10–13.
27. G. L. Beck, O. T. Farmer, *J. Anal. Atomic Spectrometry* **3** (1988) 771–773.
28. G. L. Beck, J. P. Fraley, *Teledyne Wah Chang procedure ASP-OES-I*, Rev. O, 1988.
29. J. Schlewitz, M. Shields, *At. Absorpt. Newsl.* **10** (1971) 39–43.
30. J. A. Ewen, L. Haspelslagh, J. L. Atwood, H. Zhang, *J. Am. Chem. Soc.* **109** (1987) 6544–6545.
31. D. C. Tran et al. in J. Lucas, C. T. Moynihan (eds.): *Halide Glasses I, Material Science Forum*, vol. 5, Trans Tech Pub., Switzerland 1985, 339–352.

32. B. D. James, B. E. Smith, *Synth. React. Inorg. Met. Org. Chem.* **4** (1974) 461-465.
33. J. A. Jansen, J. E. Gozum, D. M. Pollina, G. S. Girolami, *J. Am. Chem. Soc.* **110** (1988) 1643-1644.
34. E. Rudy: "Ternary Phase Equilibria in Transition Metal-Boron-Carbon-Silicon Systems", Part V, *Compendium of Phase Diagram Data*, AFML-TR-65-2, Air Force Materials Laboratory, Wright-Patterson AFB, Ohio, 1969, pp. 166-167.
35. S. Mazumdar, H. S. Ray, *J. Appl. Chem. Biotechnol.* **4** (1972) 565-576.
36. S. N. Flengas, J. F. Dutrizac, *Metall. Trans. B* **8B** (1977) 377-385.
37. E. M. Larsen, J. W. Moyer, F. Gil-Arno, M. J. Camp, *Inorg. Chem.* **13** (1974) 574-581.
38. Teledyne Industries, US 4072506, 1975 (J. Megy).
39. W. M. Mueller, J. P. Blackledge, G. G. Libowitz: *Metal Hydrides*, Academic Press, New York 1968, pp. 321-330.
40. In [34], p. 671.
41. E. Rudy, B. F. Kieffer, E. Baroch, *Planseeber. Pulvermetall.* **26** (1978) 105-115.
42. D. C. Bradley, R. C. Mehrotra, D. P. Gaur: *Metal Alkoxides*, Academic Press, New York 1978.
43. D. J. Cardin, M. F. Lappert, C. L. Raston: *Chemistry of Organo-Zirconium and -Hafnium Compounds*, Ellis Horwood Ltd., Chichester 1986.
44. P. C. Wailes, R. S. P. Coutts, H. Weigold: *Organometallic Chemistry of Titanium, Zirconium, and Hafnium*, Academic Press, New York 1974.
45. J. Schemel: *ASTM Manual on Zirconium and Hafnium*, ASTM STP 639, Philadelphia 1977.
46. *National Fire Codes*, vol. 7, NFPA No. 482-1987, National Fire Protection Association, Boston 1988.
47. C. F. Kittle, E. R. King, C. T. Bahner, M. Bruler, *Proc. Soc. Exp. Biol. Med.* **76** (1951) 278-282.
48. T. J. Haley, R. Raymond, N. Komesu, H. C. Upham, *Toxicol. Appl. Pharmacol.* **4** (1962) 238-246.

## 32 Vanadium

GÜNTER BAUER (RETIRED), VOLKER GÜTHER, HANS HESS, ANDREAS OTTO, OSKAR ROIDL, HEINZ ROLLER, SIEGFRIED SATTELBERGER

32.1 History	1471	32.5.2 Production of Vanadium Metal and its Alloys	1480
32.2 Properties	1471	32.6 Uses	1482
32.3 Occurrence	1472	32.7 Compounds	1483
32.4 Processing of the Raw Materials	1475	32.8 Analysis	1485
32.4.1 Iron Ores and Titanomagnetites as Raw Materials	1476	32.9 Economic Aspects	1485
32.4.2 Processing of Other Raw Materials	1478	32.10 Environmental Protection and Toxicology	1486
32.5 Production of Vanadium	1480	32.11 References	1488
32.5.1 Reduction Behavior of Vanadium Oxides	1480		

### 32.1 History [1]

In 1801, MANUEL DEL RIO discovered vanadium in Mexican lead vanadate ore. In 1831, SEFTSTRÖM detected the element in converter slags from certain iron ores, and named it after the Norse goddess of beauty, Vanadis.

Vanadium metal was first produced in powder form by ROSCOE in 1867-1869 by reduction of vanadium dichloride with hydrogen. MARDEN and RICH obtained ductile vanadium by reducing vanadium pentoxide,  $V_2O_5$ , with calcium metal.

The first major application of vanadium was in 1903 in England, where a vanadium-alloyed steel was produced on an 18 t scale [2]. In 1905 HENRY FORD recognized the advantages of vanadium steel and promoted its use in automobile construction. Today vanadium is of major importance as an alloying component in steel and titanium alloys and as a catalyst for chemical reactions.

### 32.2 Properties

Vanadium has two stable isotopes:  $^{51}V$  (99.75%) and  $^{50}V$  (0.25%). Unstable isotopes of relative atomic mass 48, 49, and 52 have half-lives ranging from 4 min to 600 d. The electronic configuration is  $1s^2 2s^2 p^6 3s^2 p^6 d^3 4s^2$ . Vanadium is steel gray with a bluish tinge.

It is ductile, and can be forged and rolled at ambient temperature.

Vanadium, together with niobium and tantalum, belongs to group 5 of the periodic table. It has a high melting point and good corrosion resistance at low temperature.

**Physical Properties.** The most important physical properties of vanadium are listed in the following [1, 3-6]:

Relative atomic mass	50.9415
Crystal structure	body-centered cubic
Lattice constant $a$	0.30238 nm
Density	6.11 g/cm <sup>3</sup>
$mp$	1929 ± 6 °C
Heat of fusion	21 500 ± 3000 J/mol
Specific heat at 298 K	24.35 ± 0.10 Jmol <sup>-1</sup> K <sup>-1</sup>
for 298-990 K	$C_p = 24.134 + 6.196 \times 10^{-3}T - 7.305 \times 10^{-7}T^2 - 1.3892 \times 10^{-11}T^3$
for 900-2200 K	$C_p = 25.9 - 1.25 \times 10^{-4}T + 4.08 \times 10^{-6}T^2$
for liquid V	47.43
Vapor pressure at 2190 K	3.73 Pa
at 2200 K	4.31
at 2300 K	12.53
at 2400 K	30.13
at 2500 K	87.86
at 2600 K	207.6
for liquid V, mbar	$\log p = -24.265 \times 10^3 T^{-1} + 9.65$
Heat of vaporization	465.9 kJ/mol
Linear coefficient of expansion	
at 20-200 °C	$7.88 \times 10^{-6}$
at 20-500 °C	$9.6 \times 10^{-6}$
at 20-900 °C	$10.4 \times 10^{-6}$
at 20-1100 °C	$10.9 \times 10^{-6}$
Specific electrical resistivity at 20 °C	$24.8 \times 10^{-6} \Omega cm$
Temperature coefficient	

for 0–100 °C	0.0034 $\mu\Omega\text{cm/K}$
Thermal conductivity at 100 °C	0.31 $\text{Jcm}^{-1}\text{K}^{-1}\text{s}^{-1}$
at 500 °C	0.37
Superconductivity, transition temperature	5.13 K
Capture cross section for thermal neutrons	4.8 barn

**Mechanical Properties.** The mechanical properties of vanadium are strongly dependent on purity and hence on the production method used. In particular, the elements O, H, N, and C increase the hardness and tensile strength and decrease the ductility (elongation) [7]. The most important mechanical properties are listed in Table 32.1 [3, 4, 7].

**Table 32.1:** Mechanical properties of vanadium metal.

	Commercial purity	High purity
Tensile strength $\sigma_B$ , N/mm	245–450	180
Extension, %	10–15	40
Vickers hardness HV 10, N/mm	80–150	60–70
Modulus of elasticity, N/mm	137 000–147 000	
Poisson's ratio	0.35	

**Chemical Properties.** Vanadium is stable in air below 250 °C. On prolonged storage the surface becomes bluish-gray to brownish-black, and significant oxidation takes place in air above 300 °C. Vanadium absorbs hydrogen in interstitial lattice sites at elevated temperatures (up to 500 °C). The metal becomes brittle and can easily be powdered. This hydrogen is liberated on heating to 600–700 °C in vacuum. At low temperature, a hydride phase ex-

**Table 32.2:** Principal vanadium minerals [12, 13].

Mineral and chemical formula	% V	% $\text{V}_2\text{O}_5$	Occurrence
Roscoelite $[\text{KV}_2(\text{OH})_2/\text{AlSi}_3\text{O}_{10}]$	11.2–14.0	20–25	in uranium–vanadium ores; e.g., Colorado Plateau, USA
Montroseite $(\text{V, Fe})\text{OOH}$	45.4	81.0	
Carnotite $\text{K}_2[(\text{UO}_2)_2/\text{V}_2\text{O}_8] \cdot 3\text{H}_2\text{O}$	10.3	18.3	
Tyuyamunite $\text{Ca}[(\text{UO}_2)_2/\text{V}_2\text{O}_8] \cdot 5\text{--}8\text{H}_2\text{O}$	11.1	19.8	
Francevillite $(\text{Ba, Pb})[(\text{UO}_2)_2/\text{V}_2\text{O}_8] \cdot 5\text{H}_2\text{O}$	9.9	17.7	
Corvusite $\text{V}_2^{4+} \cdot \text{V}_{12}^{3+}\text{O}_{34} \cdot n\text{H}_2\text{O}$	40.8	72.8	
Vanadinite $\text{Pb}_2[\text{Cl}/(\text{VO}_4)_3]$	10.2	18.2	in Pb, Zn, Cu vanadate ores; e.g., Otavi Mountains, Namibia
Descloizite $\text{Pb}(\text{Zn, Cu})[\text{OH}/\text{VO}_4]$	12.7	22.7	
Mottramite $\text{Pb}(\text{Cu, Zn})[\text{OH}/\text{VO}_4]$	10.5	18.8	
Patronite $\text{VS}_4$ or $\text{V}_2\text{O}_5$	16.8	ca. 30	in asphaltites; e.g., Mina Ragra, Peru
Magnetite <sup>a</sup> $\text{Fe}_2^2+ \cdot \text{Fe}^{3+}\text{O}_4$	<0.5–1.5	<1.2–2.7	in titanomagnetite ores; e.g., Bushveld, South Africa

<sup>a</sup> Several varieties exist in which there is partial replacement of  $\text{Fe}^{3+}$  by V, Ti, Al, and Cr, and of  $\text{Fe}^{2+}$  by Ti, Mg, Mn, and other elements. The vanadium- and titanium-containing magnetites are generally referred to as titanomagnetites.

ists in the V–H system [7]. Vanadium reacts with nitrogen at > 800 °C to form vanadium nitrides. It has a high affinity for carbon, forming carbides at 800–1000 °C. Data on the solubility of O, N, H, and C in vanadium and the reactions that occur with these elements can be found in [7, 8].

In its compounds, vanadium exhibits the oxidation state II, III, IV, or V. It is relatively stable towards dilute sulfuric, hydrochloric, and phosphoric acids, but is dissolved by nitric and hydrofluoric acids. Its corrosion resistance towards tap water is good, and towards seawater moderate to good, but pitting does not occur. Vanadium is resistant to 10% sodium hydroxide solution, but is attacked by a hot solution of potassium hydroxide [1, 3, 4, 9, 10]. Vanadium and some vanadium alloys have good corrosion resistance towards molten low-melting metals and alloys, especially alkali metals, which are used in nuclear reactors as coolants and heat-exchange media [11].

### 32.3 Occurrence

Vanadium is present in the earth's crust at a mean concentration of 150 g/t, and is therefore one of the more common metals. It is more abundant than copper and nickel, and of similar abundance to zinc. Vanadium forms several minerals, of which the most important are listed in Table 32.2 [12, 13].

In the early 1900s, vanadium was obtained almost exclusively from Peruvian patronite. As these deposits became exhausted, descloizite ores were mined in southern Africa, Namibia, and Zambia.

After World War II, the continental sedimentary uranium- and vanadium-containing carnotite deposits of the Colorado Plateau and the marine sedimentary vanadium-bearing phosphate deposits of Idaho became important. There are also uranium vanadium reserves in Yeellirrie, Western Australia, and in the Ferghana Basin the Kirghiz, Tajik, and Uzbek Republics [13].

Vanadium production greatly increased from the mid-1950s with the mining and processing of titanomagnetites. This type of raw material can be used directly for vanadium extraction, or it can be employed to obtain vanadium-containing pig iron from which an oxidation slag highly enriched in vanadium is produced. This development began in Finland, followed by South Africa and smaller producers in Norway and Chile. Titanomagnetites have also been mined in the former Soviet Union and China in large quantities since the early 1960s and 1970s, respectively. The vanadium-bearing titanomagnetite deposits are of magmatogenic origin, and occur in many parts of the world. The most important reserves mined today include the Bushveld deposit in South Africa, Katschkanor in the Urals of Russia, Lanshan and Chienshan in the Sichwan province of China, and a deposit in New Zealand. The titanomagnetites of the Urals and in the Sichwan province are palaeozoic complexes.

The mines at Otanmäki and Mustavaara in Finland and RØdsand in Norway were shut down during the 1980s.

Production of lead zinc vanadates in Namibia had been discontinued by the end of the 1970s.

Since the 1980s, a new type of secondary raw materials has gained importance, i.e., residues of mineral oil processing. Most crude oils contain vanadium in amounts ranging from ca. 10 ppm (Middle East) to 1400 ppm (Central

America). In petrochemical refining, vanadium is retained in boiler residues and fly ashes from incineration, with vanadium contents between a few percent and 40%. The total amounts greatly exceed current world consumption.

Noteworthy is an aqueous emulsion of a highly viscous crude from the Orinoco basin in Venezuela (Orimulsion) whose combustion yields fly ashes containing 10% vanadium.<sup>9</sup>

With environmental legislation becoming stricter, emission and deposition of these residues will be drastically reduced so that they will have increasingly to be processed.

Other, less important vanadium sources are: vanadium-containing waste salts from bauxite production, and spent catalysts from the chemical and petrochemical industries. The extraction of vanadium from currently available raw material sources (except direct processing of titanomagnetite) is always coupled with the production of other metals or energy. The most important sources are shown in Table 32.3.

**Table 32.3:** Vanadium production as a by-product.

Raw material	Coupled product	Vanadium by-product
Titanomagnetites	iron/steel	vanadium slag
Mineral oils	energy/petrochemicals	fly ashes boiler residues
Uranium–vanadium ores	uranium	petrochemical residue
Bauxite	alumina	vanadium salt
Phosphates	phosphorus	vanadium-containing Fe–P salamander
Lead vanadates	lead, zinc	vanadium slag

**Table 32.4:** Estimate of the world reserves and reserve base of vanadium in  $10^3$  tonnes of vanadium content (% given in parentheses).

Geographic area	Reserves		Estimated reserves 1985
	1985	1990	
North America	185 (4.0)	135 (3.2)	2500 (13.7)
South America	25 (0.5)		130 (0.7)
Former USSR	2900 (60.4)	2631 (61.7)	4500 (24.6)
South Africa	950 (19.7)	862 (20.2)	8600 (47.0)
China	670 (14.0)	500 (14.2)	1800 (9.8)
Pacific	35 (3.1)	30 (0.7)	570 (3.1)
<b>Total</b>	<b>4800 (100)</b>	<b>4267 (100)</b>	<b>18 300 (100)</b>

**Table 32.5:** World production of vanadium-containing commodities by country, given in tonnes of vanadium content [14].

Countries	1985	1986	1987	1988	1989	1990	1991	1992	1993
China <sup>a</sup>	5 500	5 500	5 500	5 500	4 500	4 500	4 500	4 500	5 000
Finland	2 590								
South Africa <sup>b</sup>	17 000	18 600	17 300	19 900	16 500	17 000	15 500	14 300	16 000
Former USSR	11 500	11 500	11 600	11 600	9 600	9 600	8 000	6 000	7 900
United States (total)	4 000	3 600	3 800	3 500			5 600	5 300	5 500
from catalysts and ashes	2 970	2 560	2 760	2 480					
Japan <sup>c</sup>	925	1 020	1 020	1 020			600	800	
New Zealand							2,200	1 700	
<b>Total</b>	<b>45 700</b>	<b>44 000</b>	<b>42 100</b>	<b>45 300</b>	<b>31 600</b>	<b>31 600</b>	<b>35 800</b>	<b>33 200</b>	<b>34 500</b>

<sup>a</sup> Estimated.<sup>b</sup> South Africa: roughly 40% is pentoxide and vanadate products and 60% is vanadiferrous slag products.<sup>c</sup> Spent catalyst and petroleum ashes.

**Resources and Production.** Known and estimated mineral reserves are listed in Table 32.4.

In this table the vanadium containing carbonic shells (very low concentration) and the petroleum ashes/residues are not included, although these oils contain tremendous amounts of vanadium.

Assessment of world reserves by studying the geology of deposits suggests that it will be possible to discover further workable deposits in the region of the widely distributed titanomagnetites in the old shields. The Indian shield in the Singhbhum (Bihar) and Magurbhanj (Orissa) regions, the Australian shield in Western Australia, the Canadian shield in Québec and Ontario, and the Finno-Scandinavian shield all show great promise. However, little is so far known about the Brazilian shield. The enormous vanadium reserves in the titanomagnetites cannot yet be even approximately quantified.

The world production of vanadium by country is listed in Table 32.5 [14].

Comparison of Tables 32.4 and 32.5 shows that the largest producers, South Africa and Russia, have also the largest mineral reserves. The next two producing countries China and the United States have comparatively small reserves of such origin.

**Details of the Most Important Deposits.** The Bushveld deposit in South Africa is an oval, bowl-shaped complex in a magmatic layer extending over an area of 65 000 km<sup>2</sup>. The ores were deposited in the following order:

chromite, platinum ores, vanadium-containing titanomagnetites, and tin ores. In all, 21 magnetite layers have been found in the main and upper zones of this deposit. The titanomagnetites have the following chemical composition (%):

Fe	55.8–57.5	Cr <sub>2</sub> O <sub>3</sub>	0.13–0.45
V <sub>2</sub> O <sub>5</sub>	1.4–1.6	Al <sub>2</sub> O <sub>3</sub>	2.5–3.5
TiO <sub>2</sub>	12.2–13.9	SiO <sub>2</sub>	0.9–1.5

The V<sub>2</sub>O<sub>5</sub> content can be as high as 2.4% in exceptional cases.

Production by Highveld Steel & Vanadium is based on ore containing 1.6% V<sub>2</sub>O<sub>5</sub> from the Mapochs mine, situated 90 km NNE of Middleburg. The reserves contain 200 × 10<sup>6</sup> t ore. Mining is by the open pit method, and the maximum ore production capacity is 8000 t/d [13].

Other South African titanomagnetite deposits include the Kennedy's Vale mine, with a production capacity of 6000 t/d (though not currently producing) and two mines near Brits, each with a production capacity of 5000–6000 t/d.

There are a number of lead vanadate deposits in the Otavi Mountains in Namibia. Mount Aukas, near Grootfontein, has deposits of 2 × 10<sup>6</sup> t ore containing 15% Zn, 4% Pb, and 0.5% V<sub>2</sub>O<sub>5</sub>. Deep mining has been discontinued since 1978. The mined ore, which was processed by flotation, yielded the following products: lead sulfide concentrate, zinc sulfide concentrate, willemite concentrate, cerussite concentrate, and a vanadium concentrate containing 17% V<sub>2</sub>O<sub>5</sub>, 43% Pb, and 17% Zn.

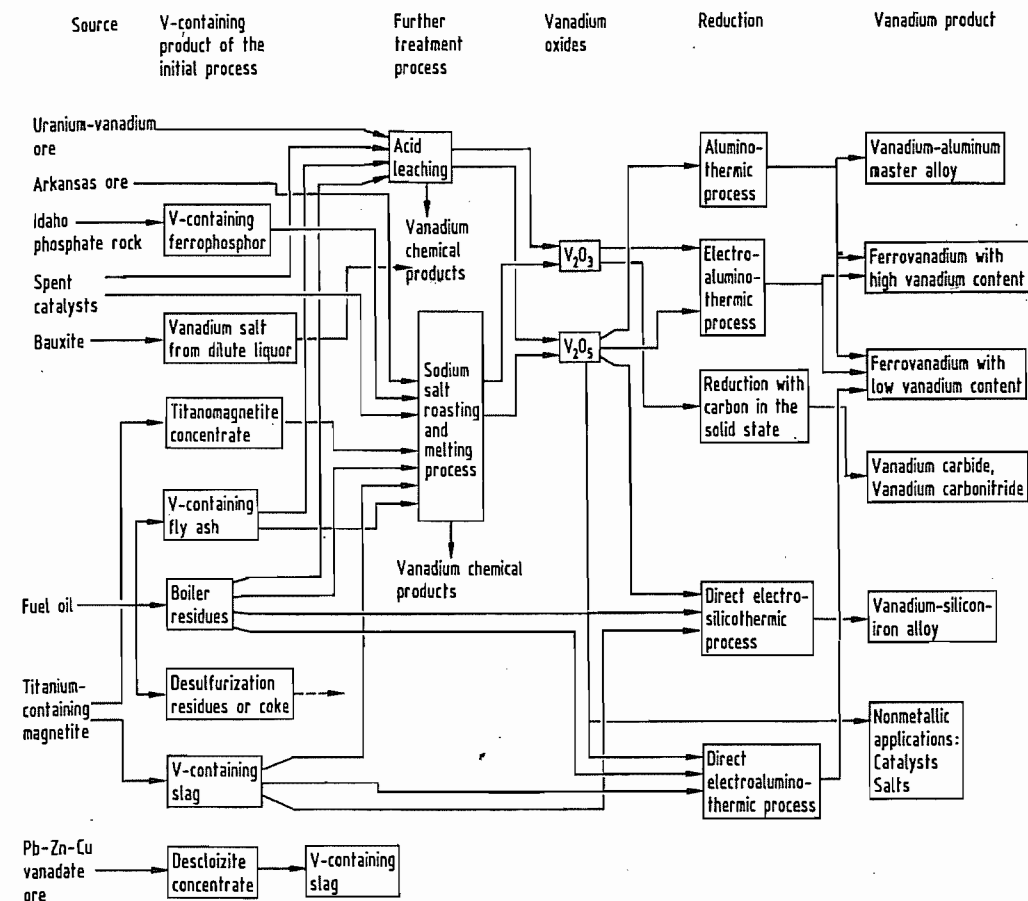
**Figure 32.1:** Treatment of vanadium raw materials [15].

The titanomagnetite deposits at Otanmäki and Mustavaara in Finland had reserves of 15 × 10<sup>6</sup> t ore containing 35–40% Fe, 13% TiO<sub>2</sub>, and 0.45 V<sub>2</sub>O<sub>5</sub>, and 40 × 10<sup>6</sup> t ore containing 17% Fe, 3.1% TiO<sub>2</sub>, and 0.36% V<sub>2</sub>O<sub>5</sub> [14]. The production capacity of the Otanmäki deep mine was ca. 1 × 10<sup>6</sup> t/a ore. Magnetite containing 69% Fe, 2.5% TiO<sub>2</sub>, and 1.07% V<sub>2</sub>O<sub>5</sub> together with ilmenite and pyrite were obtained by magnetic separation and flotation. Both mines were closed in the 1980s.

The Colorado Plateau in the United States contains the main mining area of the UraVan mineral belt, > 1100 km long, in SW Colorado and SE Utah. This belt contains irregular lenticular ore bodies, normally < 3000 t, with

0.2–0.3% U<sub>3</sub>O<sub>8</sub> and 0.85–1.4% V<sub>2</sub>O<sub>5</sub>. The oxidation region contains the minerals carnotite, tyuyamunite, montroseite, and pascoite, and the unoxidized region contains the minerals coffinite, pitchblende, and corvusite. These ores are extracted in small deep mine workings which produce ca. 0.4 × 10<sup>6</sup> t/a ore.

## 32.4 Processing of the Raw Materials

The raw materials used today include the titanomagnetite ores and their concentrates, which are sometimes processed directly, vanadium slags derived from the ores, oil combustion residues, residues from the



hydrodemetallization (HDM) process, and spent catalysts (secondary raw materials). A summary of the processing routes is given in Figure 32.1.

### 32.4.1 Iron Ores and Titanomagnetites as Raw Materials

**Production of Vanadium Slags.** The titanomagnetite ore in lump form, containing ca. 1.51–1.7%  $V_2O_5$  (Mapoch mine in South Africa), is first pre-reduced by coal at ca. 1000 °C in directly heated rotary kilns. A further reduction is then performed in an electric arc furnace to obtain a pig iron which contains ca. 1.4%  $V_2O_5$ . The slag that is also formed contains ca. 30%  $TiO_2$ , and this is deposited on slag heaps. In a heat resistant shaking ladle the molten pig iron is oxidized with oxygen lances, causing the vanadium to be transferred to the slag. The vanadium slag contains vanadium in the form of a water-insoluble trivalent iron spinel,  $FeO \cdot V_2O_3$ , at a concentration corresponding to ca. 25%  $V_2O_5$ . This slag is the world's principal raw material for vanadium production [16].

The largest slag and vanadium producer in the western world is South Africa (see Table 32.5), most of whose production is by the Highveld Steel and Vanadium Corp. [13]. Second largest producer is the Nizhny Tagil metallurgical plant in Russia; the slag contains ca. 12–18%  $V_2O_5$ . Another producer of vanadium slag is the Pannang steelworks in Panzihua, China.

Vanadium slags were produced experimentally by W. L. GOODWIN and W. P. FIRTH in 1919, but the basic industrial process was developed by R. VON SETZ, and was first used by the Spigerverk plant in Oslo in the early 1930s. The process was then mainly used in conjunction with the Thomas process. The pig iron from the blast furnace was not directly converted to Thomas steel with addition of lime in the usual way. Instead, the vanadium was oxidized completely or partially before lime addition. As vanadium has a high affinity for oxygen, it was oxidized before the phosphorus and transferred to the slag. Slags con-

taining several percent of vanadium were obtained, depending on the vanadium content of the pig iron, whereas normal Thomas slags contain an average of only 0.5% V.

Oxidation of vanadium-containing pig iron to give vanadium-containing slag was carried out by the Röchling Iron and Steel Works in Völklingen from 1937 using a converter with a very acid lining or a continuously operating oxidizing drum. For details of these abandoned processes see [17].

**Processing of Vanadium Slags.** The main process used today to produce vanadium oxide from vanadium slags is alkaline roasting. The same process, with minor differences, is also used for processing titanomagnetite ores and vanadium-containing residues.

A vanadium slag has the following approximate composition: 14% V (= 25%  $V_2O_5$ ), 1.5% Ca, 2.5% Mg, 2.0% Al, 0.01% P, 9% metallic Fe, 32% total Fe, 7% Si, 3.5% Mn, and 3.5% Ti. The presence of the elements Ca, Mg, and Al, which form water-insoluble vanadates during alkaline roasting, leads to a reduction in yield. Silicon can cause filtration difficulties during leaching of the calcine. Phosphorus, unless removed in a separate treatment, reports practically quantitatively to the vanadium oxide, and lowers the vanadium yield in the precipitation process.

The process is shown schematically in Figure 32.2. The vanadium slag is first ground to < 100  $\mu m$  (1–11 in Figure 32.2), and the iron granules contained therein are removed. Alkali metal salts are then added, and the material is roasted with oxidation at 700–850 °C in multiple-hearth furnaces or rotary kilns (12–20) to form water-soluble sodium vanadate. During roasting, care must be taken to prevent agglomeration of the material by sintering and to ensure rapid cooling after the material leaves the furnace. The roasted product is leached with water (21 in Figure 32.2), and ammonium polyvanadate or sparingly soluble ammonium metavanadate is precipitated in crystalline form from the alkaline sodium vanadate solution by adding sulfuric or hydrochloric acid and ammonium salts at elevated

temperature (22–28). These compounds are converted to high-purity, alkali-free vanadium pentoxide by roasting. The usual commercial “flake” form of vanadium pentoxide is obtained by solidifying the melt on cooled rotating tables (29–31 in Figure 32.2).

The aluminothermic production of ferrovanadium described in Section 7.12 is also shown in Figure 32.2 (32–34), as well as wastewater purification (35–44), including the reduction of Cr(VI) to Cr(III) (35) and the crystallization of sodium sulfate (37).

In Russia, a combination of alkaline roasting and sulfuric acid leaching is used. A disadvantage of this process is the manganese content of up to 2% in the  $V_2O_5$ , caused by acid leaching.

**Direct Production of Vanadium Oxide from Titanomagnetite Ores and Clays.** If the ores contain > 1% vanadium, they can be directly converted to vanadium pentoxide. The gangue material is first removed from the ore by flotation, and the ore is then mixed with sodium carbonate, pelletized, and roasted in shaft furnaces or rotary kilns at 1000 °C.

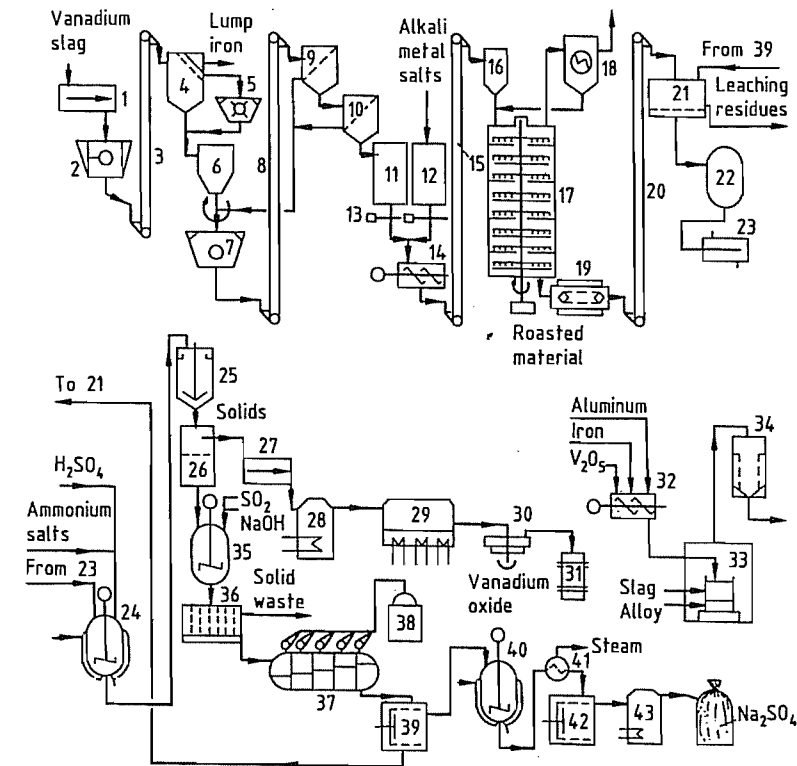

**Figure 32.2:** Production of vanadium from vanadium slags: process of the Gesellschaft für Elektrometallurgie. 1) Push feeder; 2) Jaw crusher; 3) Bucket conveyor; 4) Screen; 5) Impact mill; 6) Container with discharge device; 7) Mill; 8) Bucket conveyor; 9) Screen; 10) Air classifier; 11) Container for ground material; 12) Container for alkali metal salt; 13) Metering weighing machine; 14) Mixer; 15) Bucket conveyor; 16) Container with discharge device; 17) Multi-deck furnace; 18) Electrostatic precipitator; 19) Chain conveyor with cooling; 20) Bucket conveyor; 21) Leaching with filtration; 22) Storage container; 23) Double-tube heat exchanger; 24) Precipitation vessel; 25) Thickener; 26) Plate filter; 27) Continuous feeder; 28) Dryer; 29) Melting furnace; 30) Cooled rotary table; 31) Packing; 32) Mixer; 33) Aluminothermic reaction; 34) Bag filter; 35) Precipitation vessel; 36) Filter press; 37) Cooling with crystallization; 38) Steam generation; 39) Pusher centrifuge; 40) Melting vessel; 41) Heat exchanger; 42) Pusher centrifuge; 43) Dryer.

The sodium metavanadate formed is leached out with water, and vanadium pentoxide is obtained from this by the same method as that used in the roasting process for vanadium slags. The leach residue is used to produce pig iron if its ilmenite content is sufficiently low [15].

### 32.4.2 Processing of Other Raw Materials

Hydrometallurgical methods or a combination of pyrometallurgical and hydrometallurgical processes are used to produce vanadium oxides and salts from other raw materials. In the combined processes, thermal treatment is followed by alkaline or, more rarely, acid processing.

**Acid Processes.** Vanadium-containing oil residues and spent catalysts are digested with sulfuric acid, often under reducing conditions with addition of  $\text{SO}_2$ . After removal of the impurities, the solution is oxidized, and polyvanadate and calcium or iron vanadate are precipitated by partial neutralization of the acid [13].

Acid digestion was formerly an important method of treating carnotite, a uranium-vanadium ore. After the uranium had been removed from the solution in sulfuric acid by solvent extraction, the vanadium was partially reduced with iron powder and solvent extracted. After re-extraction, the vanadium was in the form of an acid solution of vanadyl sulfate. This was oxidized with sodium chlorate at elevated temperature, and precipitated as red cake, a mixture of sodium and ammonium polyvanadate, by adding ammonia or ammonium salts. This precipitate was roasted to convert it into alkali-containing  $\text{V}_2\text{O}_5$  [13, 18].

Historically, Pb-Zn-V concentrates from Namibia were subjected to acid treatment process. However, the mining of these ores became uneconomic and was discontinued in 1978.

The ore concentrate produced by flotation was ground and leached with dilute sulfuric

acid (10–15%). This led to the formation of insoluble lead sulfate. The solubility of the vanadium was considerably increased by simultaneously passing  $\text{SO}_2$  through the liquor. Phosphorus was removed by adding sodium zirconate to precipitate sparingly soluble zirconium phosphate. The filtrate, which contained mainly  $\text{ZnSO}_4$  and  $\text{VO}_4^{3-}$ , was treated with  $\text{H}_2\text{S}$  to precipitate As and Cu. The pH of the clear solution was increased to 1–2 by addition of sodium carbonate, and tetravalent vanadium was oxidized to the pentavalent state by heating with sodium chlorate. More sodium carbonate was added to the iron-containing solution to increase its pH to 4, precipitating a polyvanadate containing iron and sodium. This precipitate was filtered and treated with a solution of an ammonium salt to replace the sodium ions by ammonium ions. It was then dried and converted to  $\text{V}_2\text{O}_5$  by fusion.

Zinc carbonate was precipitated from the filtrate after the polyvanadate precipitation.

**Combination of Pyrometallurgical and Alkaline Hydrometallurgical Methods.** This combined process, which is preferred in practice, is used to treat vanadium-containing residues and spent catalysts. (It was formerly also used for V-containing clays, phosphates, and Pb-Zn vanadates.) The vanadium, which is mainly trivalent, is oxidized at high temperature and converted to alkali metal vanadate, which can be leached with water.

The best known process is alkaline roasting, in one version of which the ore is pelletized with sodium carbonate or compacted. After leaching, the solutions are acidified and ammonium salts are added, precipitating the vanadium as polyvanadate, which is then converted to vanadium pentoxide by calcination.

In the treatment of Pb-Zn vanadates, the zinc and lead were first reduced with carbon in the presence of added sodium carbonate in short drum furnaces. The zinc was distilled off and the lead tapped off as molten metal. The vanadium was then present in the alkaline slag in water-soluble form.

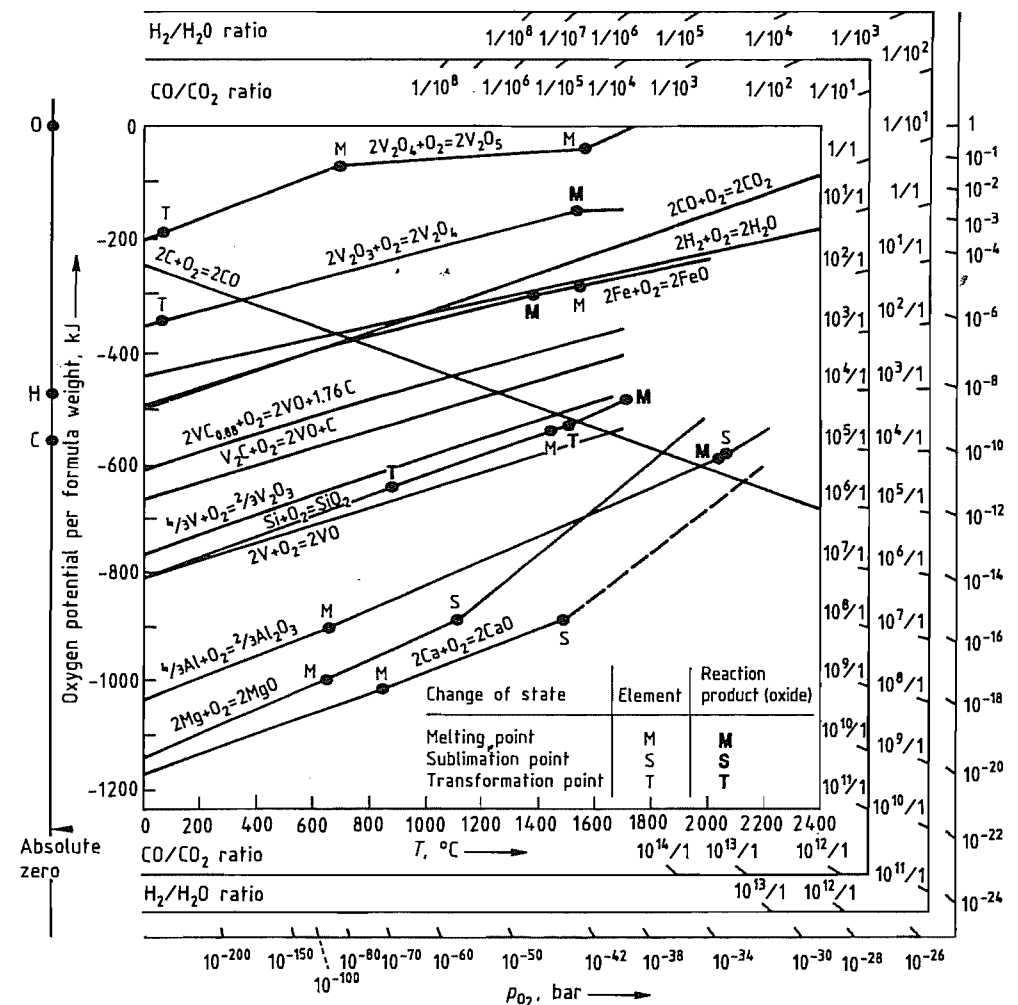

Figure 32.3: Oxygen potentials of oxides of vanadium and other elements as a function of temperature.

**Production of Vanadium Pentoxide from Oil Residues and Boiler Ash.** Appreciable amounts of vanadium are present in mineral oil, especially Venezuelan and Russian oils. The vanadium accumulates in the soot and ash of oil-fired boilers and in oil distillation residues and is sold in this form by power stations and refineries. These secondary raw materials, which sometimes contain > 50%  $\text{V}_2\text{O}_5$ , can be blended in the pyrometallurgical/hydrometallurgical process [13] or treated separately.

The extraction of vanadium from mineral oil combustion residues is gaining in impor-

tance, since the asphalt-like oil deposits of the Orinoco basin in Venezuela can now be processed into a fuel resembling mineral oil by emulsification with water with addition of magnesium nitrate. The fuel is used for energy generation in power stations. The amount of vanadium in the resulting boiler ashes is expected to reach the same order of magnitude as is currently generated in vanadium slags.

**Production of  $\text{V}_2\text{O}_5$  during the Processing of Bauxites.** Some deposits of bauxite contain high levels of vanadium, and during alumina production this ends up in the salt residue,

from which  $V_2O_5$  can be obtained. This process is more expensive than vanadium production from slags and causes severe wastewater treatment problems due to the arsenic originating from the raw material [19]. Small amounts of vanadium are obtained by this method in India and Hungary [13].

## 32.5 Production of Vanadium

### 32.5.1 Reduction Behavior of Vanadium Oxides

The most important oxide obtained on treating raw materials is vanadium pentoxide,  $V_2O_5$  (see Section 32.6).

The oxygen partial pressure in equilibrium with the vanadium oxides in accordance with the equations

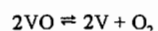
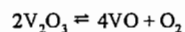
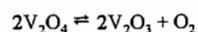
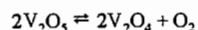

can be calculated from thermodynamic data [20]. The reactions are strongly endothermic, and have positive free enthalpies in the temperature range 298.15–2000 K (Figure 32.3).  $V_2O_5$  is the only oxide which dissociates to a large extent, the oxygen pressure reaching 0.08 MPa at 2000 K. In the presence of reducing gases such as CO and  $H_2$ , the higher oxides are reduced to  $V_2O_3$ :

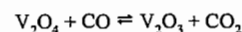

The reduction of  $V_2O_3$  by CO or  $H_2$  in accordance with the equation

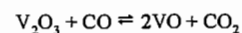

does not go to completion [20], but reduction by carbon is almost complete:

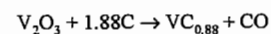

The reaction of VO with carbon initially gives vanadium carbide:

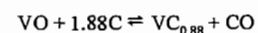

In the further reaction of oxide with carbide,

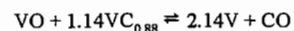

it can be calculated from thermodynamic data [20] that the CO pressure will reach ca. 600 Pa at 2000 K. However, VO and C are soluble in vanadium at high temperature. This does not favor carbothermic reduction to pure vanadium metal even under high vacuum, and it is difficult to obtain a metal with low C and O contents [1].

For the metallothermic reduction of vanadium oxide silicon, aluminum, calcium, and magnesium could be considered as possible reagents, of which calcium and magnesium have an especially strong reduction potential. However, reduction with aluminum is incomplete, the vanadium produced being either oxygen-containing and low in aluminum, or aluminum-containing and low in oxygen [21], which, in addition, leads to loss of vanadium in the slag. In the production of VAl, a low-oxygen, aluminum-containing alloy is refined in a second stage using a vacuum induction furnace and is adjusted to the derived final composition. The refinement of aluminum-free vanadium metal is performed in an electron-beam furnace. The even less complete reduction with silicon is only used in the production of ferrovanadium, as the reaction proceeds better in the presence of iron.

Reduction of the oxides with calcium and magnesium goes almost to completion. As these metals are volatile, it is advantageous to carry out the reaction in closed vessels.

### 32.5.2 Production of Vanadium Metal and its Alloys

**Reduction of Vanadium Oxide with Carbon.** Carbothermic reduction of vanadium oxides is possible, but the vanadium produced is of high oxygen and carbon content; thus, this method is rarely used in practice. Also, the formation of a low-melting ternary eutectic (96.6% V, 2.8% C, 0.6% O;  $mp$  1500 °C) prevents the reaction going to completion [22].

Avoidance of these problems by reducing vanadium oxide with vanadium carbide (carbidothermic production) has been proposed [23, 24]. High-purity vanadium ( $\geq 99.8\%$  V) can be obtained by multiple sintering (two indirect sintering stages, one direct stage, and post-sintering).

**Reduction of  $V_2O_5$  with Calcium.** A pressure vessel lined with pure magnesium oxide is used in this process. A mixture of high-purity  $V_2O_5$ , double-distilled calcium chippings, and some high-purity sulfur as a booster is caused to react by heating [25]. This technique leads to a compact metal regulus (8–12 kg, 99.5–99.8% V) which is well separated from the slag. With a calcium excess of up to 70%, a vanadium yield of 85–90% is obtained. The Vickers hardness (HV 10) of this vanadium metal is 80–180, depending on the impurities present (mainly O, N, C, and Si) [1].

**Reduction of  $V_2O_5$  or  $V_2O_3$  with Aluminum** [26, 27]. The reduction

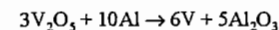

is self-sustaining, i.e., after initiation it proceeds without additional heating. The metal and slag are melted and separate well from each other. An excess of heat is produced during reduction. For process control, only a fraction of the material is ignited primarily and further material is then charged to the melt. To further decrease the exothermicity, a mixture of  $V_2O_5$  and  $V_2O_3$  is used. In the reduction of  $V_2O_3$  with aluminum, boosters such as  $KClO_3$  must be added to increase the reaction heat.

In the process developed by Teledyne Wah Chang Albany [28], a vanadium–aluminum alloy containing 13–15% Al is obtained by the aluminothermic reaction of high-purity  $V_2O_5$  with aluminum powder in a closed vessel. The steel reaction vessel is lined with aluminum oxide at the bottom and in the reaction zone. After evacuation, it is purged several times with helium, and the charge is then electrically ignited with a heated resistance wire. The metal blocks obtained are refined in an electron-beam furnace by remelting several times. The high aluminum content leads to the re-

moval of most of the oxygen by volatilization of aluminum suboxides, but nitrogen and silicon cannot be removed by this method. A purity of 99.93% V can be achieved.

In a similar process [29], the metal produced in a closed reactor by the aluminothermic method is treated at 1700 °C and  $10^{-4}$  Pa in a resistance-heated vacuum furnace, causing most of the aluminum to volatilize. Further purification by melting in an electron-beam furnace gives 99.93% pure metal.

**Refining.** Vanadium–aluminum alloys produced aluminothermically can be refined by molten salt electrolysis (electrorefining) [26]. A metal containing ca. 4.8% Al, 0.09% O, and 0.08% N can be refined by this method to give 99.6% pure vanadium.

The most effective purification of technically pure vanadium is achieved by the van Arkel process. Vanadium and iodine are heated together in a closed, evacuated tube, forming  $VI_2$  and  $VI_3$ . These are then sublimed and decomposed in a second reaction chamber on a tungsten or vanadium wire heated to 800 °C, yielding a 99.95% pure vanadium. The equipment required is complex and expensive, and the industrial potential is limited.

**Production of Semifinished Products (Sheet, Rods, Tubes, Wire).** The cast blocks of vanadium metal and alloys have a coarse structure which must first be converted into a fine-grained structure by extruding or forging at 900–1200 °C and then annealing. To prevent reaction of the vanadium with atmospheric oxygen and nitrogen, the blocks are encased in an iron or stainless steel cladding by vacuum welding. Owing to the good ductility of vanadium, subsequent metal working by rolling, forging, or drawing can be carried out at 100–500 °C. Pure vanadium can normally be formed at room temperature into thin sheets, wires, and tubes.

Vanadium and vanadium alloys can be welded using tungsten electrodes protected by an inert gas (TIG welding). Vanadium can be machined like niobium and tantalum. Excessive heating due to machining at high speeds must be avoided [30, 31].

## 32.6 Uses

Vanadium is mainly used as an alloying element in the steel industry, other major areas of use are [32, 33]

Steel	ca. 85%
Nonferrous alloys	ca. 9%
Chemical industry	ca. 4%
Others	ca. 2%

The second largest use area is in nonferrous alloys, mostly vanadium-containing titanium alloys and nickel-based superalloys for the aerospace industry. Additional uses are in vanadium-containing alloys for batteries and in grain refining of aluminum alloys. Vanadium compounds, principally the oxidation catalyst  $V_2O_5$ , account for only ca. 3% of vanadium consumption [12].

**Addition to Steel.** Vanadium is added to steel mainly as ferrovanadium; technical vanadium carbide and vanadium carbonitride are also used. For the simultaneous addition of vanadium and nitrogen, nitrogen-containing Fe-V alloys are available.

Even small additions of vanadium increase the tensile strength and high-temperature strength of carbon steel [1, 46], and it has a grain refining and dispersion hardening effect in tempering steels.

**Addition to Titanium.** Alloying with vanadium improves the properties of titanium. The most important alloy is TiAl6V4, which has good strength properties at room temperature and good creep resistance. It is mainly used as a wrought alloy and casting alloy in airframe construction for load-bearing components and fixing devices, and in compressor disks and blades in jet engines. Other areas of increasing importance include power stations, shipbuilding, and reactor technology [13]. Other vanadium-containing titanium alloys with similar strength properties to TiAl6V4 include TiAl3V2.5, TiV15Cr3Sn3Al3, TiV10Fe2Al3, TiAl6V6Sn2, as well as TiV13Cr11Al3 [34, 35].

In light, corrosion-resistant titanium aluminides (intermetallic  $\gamma$ -TiAl phase) with high-temperature strength, small amounts of vanadium (as well as of chromium and man-

ganese) increase ductility at room temperature, which is an important criterion for usability and workability of this otherwise brittle material [36].

**Other Uses. Alloys for Batteries.** Intermetallic phases of the  $ZrV_2$  type (Laves phases), in which vanadium is substituted partially by, e.g., Ni, Cr, Ti, or Mn, are used as electrode materials in metal hydride/nickel hydroxide batteries [37].

**Coating materials** containing vanadium and vanadium compounds are used in the electronics and glass industries as well as for wear protection.

**Gettering materials** based on Zr-V-Mn or Zr-V-Fe alloys are used for gas purification and for improving vacuums. The main component of these alloys, which contain up to 30% vanadium, is zirconium [38]. Gettering materials are specially adapted to individual applications; thus, with the exception of some products of the company SAES Getters, only a few standard alloys are marketed.

**Vanadium Metal and Alloys.** The use of vanadium as a principal component of alloys is in its infancy: As vanadium has higher thermal conductivity and strength and lower thermal expansion and density than stainless steel [39], it has been considered for cladding nuclear fuels for sodium-cooled fast breeder reactors, in the form of either pure metal or an alloy. In the United States, in the late 1960s, a large-scale development program on vanadium alloys was undertaken by the Atomic Energy Division at Westinghouse. Wide-ranging cooperative research projects in Germany in 1964–1971 are reported in [31, 40, 41]. A comprehensive review of these developments can be found in [7].

Of the vanadium alloys investigated, those in which titanium, niobium, chromium, and zirconium are the alloying elements seem the most promising.

The behavior of vanadium and its alloys in contact with lithium and sodium is described in [11, 41]. The effect of irradiation by neutrons on the strength properties of vanadium and its alloys is described in [42].

A further possible application of vanadium is in superconductivity. Vanadium-gallium alloys with composition  $V_3Ga$  are well known, but vanadium niobium alloys containing 30% Nb and vanadium-hafnium/zirconium alloys also have good superconducting properties.

## 32.7 Compounds

A large variety of vanadium compounds are used industrially: halides, oxides, nitrates, carbides, silicides, hydrides, vanadates, and organometallics.

**Vanadium Oxides.** *Vanadium pentoxide*,  $V_2O_5$ ,  $mp$  690 °C,  $\rho$  3.36 g/cm<sup>3</sup>, heat of formation  $\Delta H^{298}$  -1550.8 kJ/mol, is orange yellow in color and is traded as fused flakes or powder. Reaction with alkali metal hydroxides or ammonium hydroxide gives vanadates.  $V_2O_5$  is prepared by thermal decomposition of ammonium vanadates at 500–600 °C in an oxidizing atmosphere (air). It is by far the most important vanadium compound.  $V_2O_5$  is used as an oxidation catalyst in heterogeneous and homogeneous catalytic processes for the production of sulfuric acid from  $SO_2$ , phthalic anhydride from naphthalene or *o*-xylene, maleic anhydride from benzene or *n*-butane/butene, adipic acid from cyclohexanol/cyclohexanone, and acrylic acid from propane. Minor amounts are used in the production of oxalic acid from cellulose and of anthraquinone from anthracene.

$V_2O_5$  is used to lower the melting point of enamel frits for the coating of aluminum substrates. FeV and VAl master alloys are preferably produced from  $V_2O_5$  fused flakes due to the low loss on ignition, low sulfur and dust contents, and high density of the molten oxide compared to powder.

Further uses of  $V_2O_5$  are as a corrosion inhibitor in the  $CO_2$  scrubbing solutions of the Benfield and related processes for the production of hydrogen from hydrocarbons, as cathode in primary and secondary (rechargeable) lithium batteries, as UV absorbent in glass, in  $YVO_4$ ;  $Eu^{3+}$  red phosphors for high-pressure mercury lamps and TV screens, for glazes

[43], for yellow ( $SnO_2/V_2O_5$ ) and blue ( $ZrO_2/V_2O_5$ ) pigments [13], as colloidal solution for antistatic layers on photographic material [44], and as a starting material for the production of carbides, nitrides, carbonitrides, silicides, halides, vanadates, and vanadium salts.

*Vanadium trioxide*,  $V_2O_3$ ,  $mp$  1977 °C,  $\rho$  4.99 g/cm<sup>3</sup>, heat of formation  $\Delta H^{298}$  -1218.8 kJ/mol, black powder, is formed by thermal decomposition of ammonium vanadates at 600–900 °C in a reducing atmosphere ( $H_2$ , CO,  $CH_4$ ,  $NH_3$ ). The most important application is as an alternative to  $V_2O_5$  in the production of FeV, VAl master alloys, high-purity vanadium metal, and vanadium carbides and carbonitrides [45].

*Vanadium suboxides* such as  $V_2O_4$ ,  $mp$  1642 °C, heat of formation  $\Delta H^{298}$  -1427.37 kJ/mol, dark blue in color, or  $V_6O_{13}$ , colored bluish black, are of minor industrial importance [46]. They are produced by heating stoichiometric mixtures of vanadium oxides or by reduction of ammonium vanadates or  $V_2O_5$  in atmospheres of controlled reduction potential. Bronzes of  $V_6O_{13}$  or  $V_5O_{11}$  with  $Li_2O$  are used for lithium ion batteries.

**Vanadates.** The most important product is *ammonium metavanadate*,  $NH_4VO_3$ , heat of formation  $\Delta H^{298}$  -1551.0 kJ/mol, a white powder. Thermal decomposition starts at 70 °C. It is sparingly soluble in cold water (ca. 1%), but readily soluble in mono- and diethanolamine. It is precipitated from neutral alkali metal vanadate solutions by the addition of ammonium chloride or ammonium sulfate. Because of its ready conversion to  $V_2O_5$  at elevated temperatures in oxidizing atmospheres, it is used as a substitute in the production of, e.g., DENOX catalysts and zirconium vanadium oxide yellow ceramic colorants.

*Ammonium polyvanadate*,  $(NH_4)_2V_6O_{16}$ , is an orange powder, produced by the addition of mineral acids and ammonium salts to alkali metal vanadates at pH 2–3 [47]. It is an intermediate product in the production of vanadium pentoxide.

**Sodium ammonium vanadate**,  $2(\text{NH}_4)_2\text{O} \cdot \text{Na}_2\text{O} \cdot 5\text{V}_2\text{O}_5 \cdot 15\text{H}_2\text{O}$ , an orange powder, is precipitated from sodium vanadate solutions by the addition of ammonium salts at pH 5–6. It is almost exclusively used as a soluble oxidation catalyst for the desulfurization of  $\text{H}_2\text{S}$ -containing gases by the Stretford process.

**Sodium metavanadate**,  $\text{NaVO}_3$ , and **potassium metavanadate**,  $\text{KVO}_3$ , both white powders, are water-soluble compounds. They are added as corrosion inhibitors to  $\text{CO}_2$  washing solutions in the production of  $\text{H}_2$  from hydrocarbons.

**Vanadium Salts.** **Vanadyl sulfate**,  $\text{VOSO}_4 \cdot 5\text{H}_2\text{O}$ , is produced by the reaction of  $\text{V}_2\text{O}_5$  and  $\text{SO}_2$  in aqueous media, and forms blue, water-soluble crystals. It is used in catalyst production as alternative to  $\text{V}_2\text{O}_5$ . In multivitamin/multimineral pills it is the active component for fast energy supply to the muscles by enhancing glucose metabolism in the blood. It acts as an orally applied insulin mimic.

$\text{VOSO}_4$ , of blue color, and  $\text{V}_2(\text{SO}_4)_3$ , of green color, are the feed solutions for the vanadium redox battery. This battery contains vanadium(V) (yellow) and vanadium(II) (pink) in dilute sulfuric acid as electrodes when charged [48].

**Vanadyl oxalate**,  $\text{VOC}_2\text{O}_4$ , forms blue, water-soluble crystals and is used in catalyst production as alternative to vanadates and vanadium oxides.

**Vanadium Halides.** Only **vanadium oxytrichloride**  $\text{VOCl}_3$ ,  $mp -79.5^\circ\text{C}$ ,  $bp 126.7^\circ\text{C}$ ,  $\rho 1.82 \text{ g/cm}^3$ , a bright yellow liquid, **vanadium tetrachloride**,  $\text{VCl}_4$ ,  $bp 148^\circ\text{C}$ , a red brown liquid, and **vanadium trichloride**,  $\text{VCl}_3$ , boiling range  $300\text{--}400^\circ\text{C}$  (disproportionates), a deep purple solid, are of commercial interest. Whereas  $\text{VOCl}_3$  is stable,  $\text{VCl}_4$  slowly decomposes into solid  $\text{VCl}_3$  and  $\text{Cl}_2$ .  $\text{VOCl}_3$  is produced by the reaction of  $\text{V}_2\text{O}_5$  and carbon with chlorine gas. For the production of  $\text{VCl}_4$ , oxygen-free vanadium compounds such as vanadium carbide or vanadium carbonitride are reacted with chlorine gas. The chlorides are used as catalysts in the production of EPDM

(ethylene-propene-diene) rubber and polyethylene and are starting materials [49] for the preparation of organic vanadium compounds.

**Organic Vanadium Compounds.** Representatives of this class are vanadium(IV) and vanadium(III) acetylacetonates, naphthenates, octoates, and alkoxides (iso/n-butyl, iso/n-propyl), which are soluble in organic solvents. They are used in siccatives, antifouling paints, as catalysts for stereospecific organic synthesis, and in chemical vapor deposition.

**Vanadium Carbides.** The monocarbide, VC, has a theoretical carbon content of 19.08% and melts at  $2830^\circ\text{C}$ . It has a wide phase range. VC is isomorphous with VO and VN. Pure VC can be prepared by carburizing vanadium hydride powder with carbon in a vacuum [50]. Reaction at  $800^\circ\text{C}$  leads to vanadium carbide in which  $\text{C}:\text{V} = 0.72\text{--}0.87$ .

Industrial-grade VC is produced by heating  $\text{V}_2\text{O}_5$  or  $\text{V}_2\text{O}_3$  with carbon at  $1100^\circ\text{C}$  under a protective atmosphere of hydrogen [51], or by reacting  $\text{V}_2\text{O}_3$  with carbon in a carbon-tube furnace. The crude carbide formed in the first stage is recarburized at  $1700\text{--}2200^\circ\text{C}$  under vacuum. The final product contains 18.5–19% total-C and up to 0.5% free carbon. The VC is not completely free of oxygen because of its isomorphism with VO. VC is added to hard metals in amounts of 0.3–0.5%. It acts as a grain growth limiter [3]. Another carbide,  $\text{V}_2\text{C}$ , with a theoretical carbon content of 10.54%, also exists. This also has a large range of homogeneity, and decomposes at  $1850^\circ\text{C}$ . It is of no industrial importance as such, but is formed in all carbon-containing vanadium alloys.

**Vanadium Nitrides.** Three nitrides exist: VN,  $\text{V}_2\text{N}$ , and  $\text{V}_3\text{N}$ . The mononitride,  $mp 2350^\circ\text{C}$ , is a grayish-brown powder, isomorphous with VC and VO [52]. Its theoretical composition is 78.45% V, 21.55% N, but its range of homogeneity extends from  $\text{VN}_{1.0}$  to  $\text{VN}_{0.71}$ . It can be obtained by the reaction of vanadium tetrachloride with mixtures of nitrogen and hydrogen gas, using the technique of growth on tungsten wires at  $1400\text{--}1600^\circ\text{C}$ . Although the

preparation of VN from vanadium oxides is difficult because of the isomorphism mentioned above, a product containing 78.3% V, 21.1% N, and 0.5% O can be obtained by reduction with carbon in an atmosphere of nitrogen [51].

As vanadium carbides and nitrides are mutually soluble, vanadium carbonitrides with a wide range of C:N ratios can be prepared at  $1100\text{--}1400^\circ\text{C}$ . This is true for both  $\text{V}(\text{C}, \text{N})$  and  $\text{V}_2(\text{C}, \text{N})$ . Two broad three-phase regions extend continuously between the corresponding phases VC–VN and  $\text{V}_2\text{C}\text{--}\text{V}_2\text{N}$ .

**Vanadium Silicides.**  $\text{VSi}_2$ ,  $mp 1650^\circ\text{C}$ , can be prepared by sinter metallurgy. For example, the pure substance can be prepared by exothermic reaction sintering of vanadium and silicon powder [53]. In industry, it is obtained by the reaction of vanadium oxides with  $\text{SiO}_2$  and carbon (or with SiC) at  $1200\text{--}1800^\circ\text{C}$  under vacuum.

**Vanadium Hydrides.** In the H–V system [54] the following phases occur:  $\beta_1$ , corresponding to ca.  $\text{V}_2\text{H}$  (low temperature), 33 atom% H;  $\beta_2$ , corresponding to  $\text{V}_2\text{H}$  or  $\text{VH}$ , 33–50 atom% H;  $\delta$ , corresponding to  $\text{V}_3\text{H}_2$ , 40 atom% H;  $\gamma$ , corresponding to  $\text{VH}_2$ , 66.7 atom% H.

## 32.8 Analysis

The most important analysis is the determination of vanadium in raw materials, especially vanadium-containing slags and the commercial products vanadium oxide and ferrovanadium [55].

To determine vanadium in raw materials, the sample is fused with sodium peroxide and sodium carbonate, the solidified product is leached with water, and the vanadium-containing solution so obtained is acidified with sulfuric acid. The vanadium is completely oxidized with potassium manganate(VII) to the pentavalent state, and the solution is back-titrated with iron(II) sulfate, with diphenylamine as indicator.

In the analysis of vanadium oxide, the sample is dissolved in sulfuric acid, completely re-

duced with iron(II) sulfate to the tetravalent state, and back-titrated potentiometrically with potassium manganate(VII) solution, using a calomel reference electrode.

Ferrovanadium is also analyzed potentiometrically. The sample is dissolved in sulfuric/nitric acid, and is then oxidized by potassium manganate(VII). The vanadium, now in pentavalent form, is reduced with iron(II) solution, and potentiometrically back-titrated with potassium manganate(VII) solution, using a calomel reference electrode.

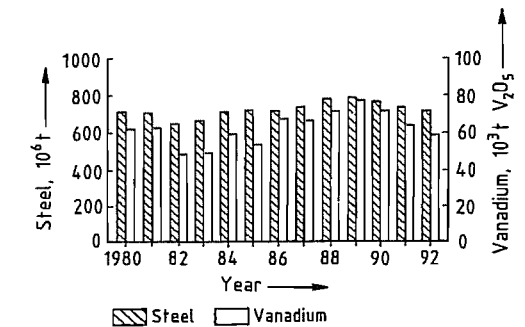

Figure 32.4: World production of steel and vanadium.

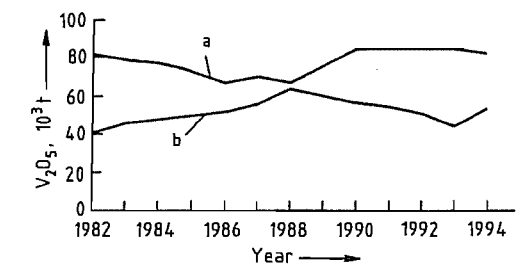

Figure 32.5: Worldwide vanadium capacity (a) and demand (b).

## 32.9 Economic Aspects

**Consumption, Production Capacity, and Prices.** The development of vanadium market prices is governed by consumer demand and existing production capacities. For main uses of vanadium and their shares see Section 32.6. The dependence of vanadium production on world steel production is shown in Figure 32.4 [56]. Total world demand is compared to available production capacities in Figure 32.5

[57]. This led to the price trend shown in Figure 32.6 [57].

For the vanadium demand of the western world, South Africa is the major exporter (Table 32.6). Vanadium in the form of slag and oxides was traded to converters in Europe, Japan, and the United States, for the production of ferrovanadium. Since 1994 most South African suppliers have installed their own ferrovanadium production capacity. This will eventually lead to the nonavailability of South African preproducts for the converters mentioned above. Their plants will have to use other raw materials, such as residues from mineral oil processing, or cease production.

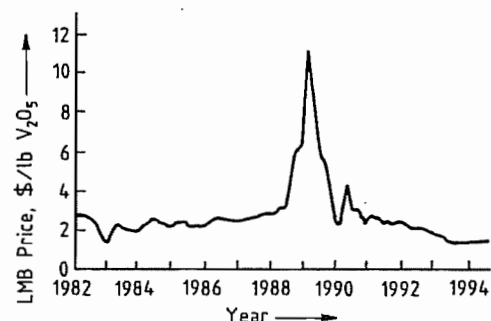

Figure 32.6: Vanadium price trends.

Table 32.6: World exports of vanadium, 1989–1992 [56] (in tonnes of  $V_2O_5$ ).

Country	Exports				
	1989	1990	1991	1992	%
South Africa <sup>a</sup>	32 950	25 989	25 561	24 000	84.7
New Zealand <sup>b</sup>	2 000	4 000	4 500	3 000	10.6
CIS	1 500	1 350	1 200	1 200	4.2
Others <sup>c</sup>	200	150	150	150	0.5
<b>Total</b>	<b>36 650</b>	<b>31 489</b>	<b>31 411</b>	<b>28 350</b>	<b>100</b>

<sup>a</sup> Including Republic of South Africa and Bophuthatswana.

<sup>b</sup> Estimates.

<sup>c</sup> China is considered to be a net importer of vanadium at present. Its re-exports are, therefore, not shown in this table.

Further suppliers of vanadium oxides are Russia, whose share for export strongly depends on its own economic development; and China, which is expected to turn from an exporter to an importer because of its high economic growth rate.

Ferrovanadium producers are listed in the following [51]:

Country	Company
Argentina	Pamet Stein Ferroaleaciones Sacifa
Austria	Treibacher Industrie AG
Belgium	SADACINV
Brazil	Termoligas metalurgicas SA Cia Paulista de ferro ligas
Canada	Masteralloy Products Inc.
China	Panzihua Iron and Steel Plant Emei Ferroalloy Plant Jinzhou Ferroalloy Plant
Czech Republic	Nikom Ferroalloy Plant
Germany	GfE Gesellschaft für Elektrometallurgie
Hungary	Ötvözetgyar, Hungaraloy
India	Birla
Japan	Awamura Metal Industry Co. Ltd. Taiyo Mining and Industrial Co. NKK Corp.
Mexico	Ferroaleaciones de México FERROMEX Ferralver SA
CIS	Chusovskoy Metallurgical Kombinat Tulachermet Kombinat
Spain	Ferroaleaciones especiales asturianas
South Africa	Highveld Steel and Vanadium Corp. Ltd. Vametco Vantech
United States	BEAR Metallurgical Corp. Shieldalloy Corp. Strategic Metal Corp., Stratcor

## 32.10 Environmental Protection and Toxicology

**Soil.** In sulfidic and oxidized form, vanadium is a ubiquitous element with an average abundance of 150 mg/kg in the earth's crust. The concentrations vary widely, between a few ppm and 1000 ppm. Depending on geological conditions, even higher values can be found, e.g., 1650 ppm vanadium in oil shales of permian copper schist [58]. The vanadium content of oil shale and mineral oil, in which it is present primarily as porphyrin complexes, is due to biological processes. Higher anthropogenic burdens can be found only in a few isolated geographic locations. In the upper layers of arable soils utilization of mineral fertilizers leads to accumulation of vanadium, which is retained and is only slightly mobile [59].

**Air.** Vanadium concentrations in uncontaminated air can reach 1 ng/m<sup>3</sup>, caused by whirled-up dust from weathered rock and by evaporation of water droplets driven off of surface waters by wind and waves. Increased

concentrations are recorded mainly in urban areas. They originate mainly from combustion of coal and especially heavy fuel oil. Concentrations of ca. 10–35 ng/m<sup>3</sup> measured in the past (maximum values of up to 1000 ppm, recorded in London, 1962) are lower today, due to the use of efficient waste air purification systems. Industrial activities are of only minor, local importance in the pollution of the air with vanadium.

**Water.** Vanadium dissolved in water is present almost exclusively in the pentavalent form. In running waters, its concentration range is ca. 0.1–220 µg/L [60], the vanadium concentration in the water correlates to these in rocks near the river source in the river bed. The sediment of creeks also mirrors the abundance in the surrounding area. Seawater contains 0.3–29 µg/L vanadium [60]. Accumulation does not occur, since the vanadium input from running waters is transferred to the sediment by precipitation and biochemical processes.

Water contamination by vanadium takes place only to a minor extent. For removing vanadium from wastewater, single- or multiple-stage precipitation with iron or lime is employed.

**Fauna and Flora.** Vanadium is considered to be essential for a number of organisms [61–63]. In vertebrates the average concentration is 0.1 mg vanadium per kg dry matter. Considerably higher concentrations (≤ 0.1 g/kg) can be found in lower organisms. Especially in one order of invertebrates (ascidians), vanadium accumulates in unusually high amounts

[64]. In some species of these organisms, the vanadium is present in green blood cells (vanadocytes) and is complexed by pyrrole rings [65]. Data on vanadium concentrations in humans vary widely, between 100 µg [66] and 17–43 mg [67]. Fat tissue, bones, teeth, bone marrow, as well as serum are especially rich in vanadium.

In general, the vanadium concentration in plants is related to that in the soil. As with animals, plants vary widely in vanadium content. For example, in fly agaric (*Amanita muscaria*) concentrations 100 times as high as in other fungi are found, independent of location. The reasons for this are not yet known [64].

**Toxicology.** Toxicity data for some vanadium compounds are given in Table 32.7. The data show a correlation of toxicity with oxidation state and solubility. Toxicity decreases with decreasing oxidation state and decreasing solubility.

In investigations of neurobehavioral, neuropsychological, psychosomatic, and psychological parameters as a function of exposure to  $V_2O_5$  in dust among workers in an industrial plant, no significant changes compared to uncontaminated persons were found, independent of the concentration of vanadium pentoxide [70].

**Occupational Safety.** For vanadium pentoxide, there is a total dust limit value (0.5 mg/m<sup>3</sup>) and a limit value for fine dust (0.05 mg/m<sup>3</sup>); in Germany, the definition of the latter is based on studies on volunteers [71].

Table 32.7: Toxicological data [68, 69].

	Oral LD <sub>50</sub> (14 d), mg/kg body weight	Inhalative LC <sub>50</sub> (14 d), mg/L	Dermal LD <sub>50</sub> (14 d), mg/kg body weight
$V_2O_5$ , analytical grade	470 (male) 467 (female)	11.09 (male) 4.3 (female)	> 2500 (male) > 2500 (female)
$V_2O_5$ , technical grade	8713 (male) 5639 (female)	> 6.65 (male) > 6.65 (female)	> 2500 (male) > 2500 (female)
Ammonium metavanadate	218 (male) 141 (female)	2.61 (male) 2.43 (female)	> 2500 (male) > 2500 (female)
Potassium metavanadate	318 (male) 314 (female)	1.85 (male) 4.16 (female)	> 2500 (male) > 2500 (female)
BiVO <sub>4</sub> –BiMoO <sub>4</sub>	> 5000	> 5.15	

## 32.11 References

1. R. Kieffer, G. Jangg, P. Etmayer: *Sondermetalle*, Springer Verlag, Wien 1971.
2. A. M. Sage: "Discovery and History of Vanadium and its Contribution to Life in the Modern World", Metals Society, 1981.
3. R. Kieffer, H. Braun: *Vanadium, Niob, Tantal*, Springer Verlag, Berlin 1963.
4. W. Rostocker: *The Metallurgy of Vanadium*, Wiley, Chapman & Hall, New York 1958.
5. *Bull. Alloy Phase Diagrams* 2 (1981) no. 1, 40-41, 146; no. 2, 172.
6. I. Barin, O. Knacke: *Thermochemical Properties of Inorganic Substances*, Springer Verlag, Berlin, Verlag Stahleisen, Düsseldorf 1973.
7. D. L. Harrod, R. F. Gold, *Int. Met. Rev.* 25 (1980) 163-221.
8. E. Fromm, E. Gebhardt: *Gase und Kohlenstoff in Metallen*, Springer Verlag, Berlin 1976.
9. H. E. Dunn, D. L. Edlung: "Vanadium", in C. A. Hampel (ed.): *Rare Metals Handbook*, 2nd ed., Reinhold, Chapman & Hall, London 1961, pp. 640-642.
10. D. Schlain, C. B. Kenehan, W. L. Ackermann, *J. Less-Common Met.* 3 (1961) 458-467.
11. R. L. Ammon, *Int. et. Rev.* 25 (1980) 255-268.
12. M. Rühle, *Metall (Berlin)* 35 (1981) 1168-1172, 1282-1285.
13. Bundesanstalt für Geowissenschaften und Rohstoffe: *Untersuchungen über Angenot und Nachfrage mineralischer Rohstoffe, XIV, Vanadium*, Berlin-Hannover 1981.
14. P. Storm: "Vanadium Sources, Applications, and Markets", *Raw Materials Report*, vol. 10, no. 3, Royal Institute of Technology, Stockholm.
15. R. K. Evans: Vanitec, reprint from *Met. Mater.*, April 1978.
16. B. Rohrmann, A. G. Raper, *J. Iron Steel Inst. London* 1970, April, 336-341.
17. *Ullmann*, 3rd ed., 18, 56.
18. L. White, *Eng. Min. J.* 177 (1976) Jan., 87-91.
19. H.-J. Retelsdorf, *Metall (Berlin)* 35 (1981) 1166-1167.
20. A. D. Mah: "Thermodynamic Properties of Vanadium and its Compounds", *Bur. Mines Rep. Invest.* 6727 (1966).
21. W. Schmidt: "Untersuchungen an Vanadiummetall und seinen aluminothermisch hergestellten Legierungen mit Aluminium und Eisen", Ph. D. Thesis, RWTH Aachen 1969.
22. M. F. Joly: *2nd United Nations Int. Conf. on the Peaceful Use of Atomic Energy*, Geneva, May 1958, Paper No. A/Cnf. 15/P/1274.
23. R. Kieffer, H. Bach, H. Lutz, *Metall (Berlin)* 21 (1967) 19-22.
24. R. Kieffer, F. Lihl, E. Effenberger, *Z. Metallk.* 60 (1969) 94-100.
25. T. T. Campbell, F. E. Block, E. R. Anderson: "Reducing Vanadium Compounds in Bomb Reactors", *Bur. Mines Rep. Invest.* 6314 (1964).
26. P. V. S. Pillai, K. U. Nair, T. K. Mukherjee, C. K. Gupta, *Trans. Indian Inst. Met.* 26 (1973) no. 6, 24-30.
27. T. K. Mukherjee, C. K. Gupta, *J. Less-Common Met.* 27 (1972) 251ff.
28. C. T. Wang, E. F. Baroch, S. A. Worcester, Y. S. Shen, *Met. Trans.* 1 (1970) no. 6, 1683-1689.
29. O. N. Carlson, H. R. Burkholder, G. A. Martsching, F. A. Schmidt: *Extractive Metallurgy Refractory Metals Proc. Symp. 1981*, pp. 191-203.
30. R. W. Buckmann, Jr., *Int. Met. Rev.* 25 (1980) 158-162.
31. M. Rühle, *Metall (Berlin)* 33 (1979) 140-147.
32. R. Hähn: "Vanadin-Gewinnung und Verwendung", *Erzmetall* 40 (1987) no. 6, 298ff.
33. O. E. Kraus, *Stahl Eisen* 109 (1989) no. 11, 547-552.
34. H. B. Bomberger, F. H. Froes, P. H. Morton: "Titanium - A Historical Perspective, Titanium Technology: Present Status and Future Trends", *Tit. Dev. Ass.* 1985.
35. K. Rüdiger, *DVS-Ber.* 53 (1978) 39-47.
36. Y.-W. Kim, *J. Met.* 46 (1994) no. 7, 30.
37. A. Züttel, F. Meli, L. Schlapbach, *Z. Phys. Chem. (München)* 183 (1994) 355.
38. K. Ichimura, M. Matsuyama, K. Watanabe, *J. Vac. Sci. Technol. A* 5 (1985) no. 2, 3-4.
39. F. L. Yaggee, E. R. Gilbert, J. W. Styles, *J. Less-Common Met.* 19 (1969) 39-51.
40. M. Schirra, *Metall (Berlin)* 33 (1979) 455-465.
41. H. U. Borgstedt, *Metall (Berlin)* 33 (1979) 264-266.
42. R. E. Gold, D. L. Harrod, *Int. Met. Rev.* 25 (1980) 232-254.
43. *Nachr. Chem. Tech.* 16 (1968) no. 2, 23.
44. Eastman Kodak, FR 7522060, 1975.
45. R. Hähn: Dissertation, RWTH Aachen 1983.
46. Combustion Engineering, US 4486400, 1984.
47. U. M. Levanto, *Acta Polytech. Scand. Chem. Technol. Metall. Ser.* 82 (1969) 37.
48. M. Skyllaskazacos et al.: "Characteristics and Performance of 1 kW UNSW Vanadium Redox Battery", *J. Power Sources* 35 (1991) 399-404.
49. Akzo Chemicals Inc.: "Polymerization Catalysts", Bulletin 92-03, 1992.
50. G. V. Samsonov, V. Ya. Vanmanko, L. N. Okhremchuk, B. M. Rud, *Izv. Akad. Nauk SSSR Neorg. Mater.* 10 (1974) no. 1, 52-56; *Chem. Abstr.* 80 (1974) 90458.
51. R. Kieffer, F. Benesovski: *Hartstoffe*, Springer Verlag, Wien 1963.
52. P. Etmayer, R. Kieffer, F. Hattinger, *Metall (Berlin)* 28 (1974) 1151-1156.
53. F. Binder, *Radex Rundsch.* 1975, no. 4, 539-540.
54. J. F. Smith, D. T. Peterson, *Bull. Alloy Phase Diagrams* 3 (1982) no. 1, 55-60.
55. Chemiker-Ausschuß: *Analyse der Metalle*, vol. 1: Schiedsanalysen, vol. 2: Betriebsanalysen, Springer Verlag, Berlin 1961.
56. G. Grohmann: *World Vanadium Review*, Report R 14/93, Rep. of South Africa, Department of Mineral and Energy Affairs.
57. W. Beattie: "Overview of Vanadium and Tungsten Commodity Markets", *Metals Week Presentation*, reprint, 19th Sept. 1994.
58. H. Fauth, R. Hindel, U. Siewers, J. Zinner: *Geochemischer Atlas Bundesrepublik Deutschland*, Bundesanstalt für Geowissenschaften und Rohstoffe, Hannover 1985.
59. R. Schnabel, C. Koch, C. Bunke, G. Schmieder: "Zum Verhalten von Vanadin in der Umwelt", *Z. Gesamte Hyg. Ihre Grenzgeb.* 30 (1984).
60. Environmental Health Criteria 81: *Vanadium*, World Health Organization, Geneva 1988.
61. F. H. Nielsen, "Studies on the Essentiality of Some Elements Ascribed as Toxic - Arsenic, Boron, Lead, Tin and Vanadium", U.S. Department of Agriculture Agricultural Research Service, Grand Forks Human Nutrition Research Center, Grand Forks, ND.
62. E. J. Underwood: "Vanadium" in: *Trace Elements in Human and Animal Nutrition*, 4th ed., Academic Press, New York 1977, pp. 388-397.
63. R. Nechay: "Mechanism of Action of Vanadate", *Ann. Rev. Pharmacol. Toxicol.* 24 (1984) 501-524.
64. Natl. Res. Council, Committee on Biolog. Effects of Atmospheric Pollutants, "Vanadium", National Academy of Science, Washington, DC, 1977, p. 117104.
65. E. P. Levine, *Science (Washington, DC)* 133 (1961) 1352.
66. A. R. Byrne, L. Kosta: "Vanadium in Foods and in Human Body Fluids and Tissues", *Sci. Total Environ.* 10 (1978) 17-30.
67. H. A. Schroeder, J. J. Balassa, I. H. Tipton: "Abnormal Trace Metals in Man: Vanadium", *J. Chron. Dis.* 16 (1963) 1047-1071.
68. J. Leuschner, H. Haschke, G. Sturm: "New Investigations on Acute Toxicities of Vanadium Oxides", *Monatsh. Chem.* 125 (1994) 623-646.
69. H. Wienand, W. Ostertag: "Bismutvanadat/molybdat - ein neuartiges Farbpigment", *Farbe + Lacke* 9 (1986) 118ff.
70. Final Report Vanadium Pentoxide Investigation, Institute for Social Medicine, Innsbruck 1993/1994, unpublished.
71. C. Zenz, B. A. Berg, *Arch. Environ. Health* 14 (1967) 709.

## 33 Rhenium

HANS-GEORG NADLER

33.1 Introduction .....	1491	33.5 Rhenium as an Alloying Component .....	1495
33.2 Properties .....	1491	33.6 Uses.....	1496
33.3 Occurrence and Raw Materials.....	1492	33.7 Compounds.....	1496
33.3.1 Molybdenite.....	1492	33.7.1 Oxides and Chalcogenides.....	1496
33.3.2 Recovery from Spent Catalysts and Alloys .....	1492	33.7.2 Halides .....	1497
33.4 Production.....	1493	33.7.3 Carbonyls.....	1498
33.4.1 Recovery from Flue Gases in Molybdenite Roasting .....	1493	33.8 Uses of Rhenium Compounds .....	1498
33.4.2 Production of Pure Rhenium Compounds from Gas Scrubbing Solutions.....	1494	33.9 Analysis.....	1499
33.4.3 Production of Rhenium Metal Powder and Pellets .....	1495	33.10 Economic Aspects.....	1499
		33.11 Toxicology and Physiological Effects.....	1499
		33.12 References.....	1500

### 33.1 Introduction

Rhenium is present in the earth's crust at a very low concentration (ca.  $7 \times 10^{-8}\%$ , 0.7 ppm). The element was discovered in 1925, when TACKE, NODDACK, and BERG observed its X-ray spectrum in concentrates and compounds obtained from the beneficiation of columbite [5].

The discoverers isolated the first gram of rhenium from 660 kg of Norwegian molybdenite ( $\text{MoS}_2$ ), which contained 2–4 ppm Re [6]. Rhenium is the most recently discovered refractory metal; it is a member of the group of high-melting metals that includes molybdenum, tungsten, niobium, and tantalum. It has the second highest melting point of all metals (3180 °C).

Industrial production of rhenium began in the 1930s at Kali Werke Aschersleben in the Harz region [7], and also at H. C. Starck, formerly Gebr. Borchers AG, in Goslar. The raw material consisted of furnace bottoms, by-products from the treatment of Mansfeld copper schists. The furnace bottoms were digested by fusion with sodium sulfate [8]. Then, after a complicated chemical separation process, rhenium was isolated as potassium

perrhenate, which was reduced with hydrogen to give the impure metal.

An important advance in rhenium technology was the production of the element from flue dusts from the roasting of molybdenite [9]. The amount recovered from the dusts was, however, only 10–15% of the total Re content of the  $\text{MoS}_2$  concentrate. The introduction of accurate analytical methods [10] enabled material balances for rhenium extraction to be established. These showed that most of the rhenium was lost up the stack, and only a small amount remained in the flue dust or in the roasted product. The flue gas was therefore scrubbed intensively to ensure that the volatile oxides of rhenium were recovered when the molybdenite concentrate was roasted [11, 12].

### 33.2 Properties

Rhenium has the electronic configuration  $[\text{Xe}] 4f^{14} 5d^5 6s^2$ , and consists of the natural isotopes  $^{185}\text{Re}$  (37.07%) and  $^{187}\text{Re}$  (62.93%),  $\beta$ -emitter with a half-life of  $10^{11}$  years). Fused or sintered rhenium has a silvery white luster, and the powdered metal is silver gray. It has a hexagonal close-packed structure (type A3), with  $a_0 = 276$  pm and  $c_0 = 446$  pm. Rhenium



retains this lattice up to its melting point and hence does not undergo a ductile–brittle transformation, in contrast to other refractory metals.

Other physical data are listed below:

Density (20 °C)	21.0 g/cm <sup>3</sup>
Metallic radius	137 pm
Ionic radius (VII)	53 pm
Melting point	3180 °C
Boiling point	5870 °C
Heat of fusion	33 kJ/mol
Heat of sublimation $\Delta H_B$ (monoatomic gas)	+779 ( $\pm$ 8) kJ/mol
Enthalpy of formation of $\text{Re}_2\text{O}_7$	-1241 kJ/mol
Electrical conductivity	0.051 $\mu\Omega^{-1}\text{cm}^{-1}$
Specific resistivity (20 °C)	19.3 $\mu\Omega\text{cm}$
Superconductivity	1.699 K
Tensile strength (20 °C annealed)	12 MPa
Modulus of elasticity (20 °C)	459.9 GPa
Recrystallization temperature (depending on degree of working)	1300–1800 °C

Rhenium is a very heat-resistant metal, provided it does not come in contact with oxidizing agents. It is practically insoluble in hydrochloric and hydrofluoric acids. In oxidizing acids, it dissolves to form perrhenic acid ( $E^0$  for  $\text{Re}/\text{ReO}_2$ : 0.251 V).

Rhenium forms volatile oxides with oxygen at high temperature. In air at 350 °C, the heptoxide,  $\text{Re}_2\text{O}_7$ , is formed. The rate of oxidation increases with increasing air flow rate. The stability of rhenium metal components is limited due to oxide formation even below 0.133 Pa [13]. When rhenium is heated with fluorine or chlorine, the fluorides or chlorides are formed. Rhenium reacts with silicon, boron, and phosphorus at elevated temperature to form silicides, borides, and phosphides.

### 33.3 Occurrence and Raw Materials

#### 33.3.1 Molybdenite

Molybdenite,  $\text{MoS}_2$ , especially from porphyry copper ore deposits, is the preferred host mineral for rhenium, which isomorphically replaces molybdenum in the  $\text{MoS}_2$  lattice. The copper molybdenum porphyry ores contain 0.3–1.6% Cu and 0.01–0.05% Mo. The sulfides of copper and molybdenum are concentrated and separated by flotation, giv-

ing a rhenium content in the  $\text{MoS}_2$  concentrates of several hundred parts per million.

Rhenium contents (in ppm) of selected molybdenum concentrates of various origins are as follows:

<b>Canada</b>	
Island Copper	700–1300
HVC	200–400
Endako	< 100
<b>United States</b>	
Pinto Valley	1500–2000
Magma San Manuel	800
Bagdad	350
Sierrita	180
Bingham Canyon	250
Climax	30
Henderson	20
<b>Mexico</b>	
La Caridad	570
<b>Peru</b>	
Cuajone	580
Toquepala	600
<b>Chile</b>	
Chuquicamata	300
El Salvador	600
El Teniente	400
<b>Iran</b>	
Sar Cheshmeh	800
World rhenium reserves [14] (in t Re) are	
Canada	32
Chile	1306
Peru	45
CIS	594
United States	386
Others	91
World total	2453

In copper concentrates, the rhenium content is 10–50 ppm, the molybdenum content 200–600 ppm. Copper concentrates are therefore a useful source of rhenium.

#### 33.3.2 Recovery from Spent Catalysts and Alloys

Platinum–rhenium catalysts are used in the petroleum industry in the reforming process. When their activity is too low even after regeneration, the catalysts must be replaced. Valuable metals are recovered by dissolving the carrier ( $\text{Al}_2\text{O}_3$ ) in sodium hydroxide solution or sulfuric acid. Platinum remains in the residue, from which it can be recovered. Rhenium, which goes into solution, can be recovered by solid or liquid ion exchangers [15].

In addition to this hydrometallurgical procedure, a pyrometallurgical process (fusion) allows rapid concentration of the valuable metals [16]. The resulting alloys are treated by dissolution and separation processes.

The high economic value of the WRe, MoRe, and rhenium-containing superalloys means that scrap alloys of these compositions must be processed. The following processes are suitable:

- Oxidation by atmospheric oxygen to form  $\text{WO}_3$  and  $\text{Re}_2\text{O}_7$  (*bp* 362 °C) which are separated by sublimation and distillation [17]
- Fusion with NaOH and oxidizing agents such as  $\text{NaNO}_3$  and  $\text{NaNO}_2$  [18].

These initial operations are followed by isolation of the elements and crystallization of their salts.

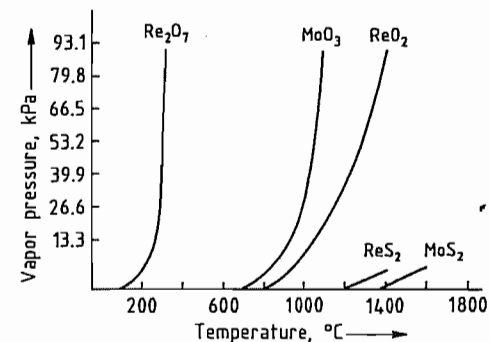

Figure 33.1: Vapor pressure of some oxides and sulfides of rhenium and molybdenum.

### 33.4 Production

#### 33.4.1 Recovery from Flue Gases in Molybdenite Roasting

Porphyry copper ores containing 0.3–1.6% Cu and 0.01–0.05% Mo are ground and concentrated by flotation. Further treatment leads to almost quantitative recovery of molybdenite.

When molybdenite (90–95%  $\text{MoS}_2$ , remainder:  $\text{SiO}_2$ , Cu, Fe, etc.) is roasted at 500–700 °C to produce technical-grade molybdenum trioxide,  $\text{MoO}_3$ , rhenium heptoxide,  $\text{Re}_2\text{O}_7$ , sublimes due to its high vapor pres-

sure, and escapes with the flue gases. The vapor pressure curves of some oxides and sulfides of rhenium and molybdenum are given in Figure 33.1 [19].

The flue gases also contain sulfur dioxide, small amounts of sulfur trioxide, selenium dioxide, and large amounts of dust ( $\text{MoO}_3$ ,  $\text{MoO}_2$ , and  $\text{MoS}_2$ ). This dust can be recovered (> 99%) in high-temperature electrostatic filters and recycled to the roasting process. In the final gas scrubbing operation, the remaining dust fraction, rhenium heptoxide, selenium dioxide, sulfur trioxide, and some of the sulfur dioxide are removed from the flue gas. The scrubbing liquor is recirculated to increase the rhenium concentration, allowing the subsequent process stages to be operated economically.

The compound  $\text{Re}_2\text{O}_7$  is readily soluble in water, forming  $\text{HReO}_4$ , so that the recovery of rhenium from the flue gases is > 90%. Multi-stage pressure jet (venturi) scrubbers enable high rhenium recovery efficiencies to be achieved, effectively removing the finest dust fractions and causing rhenium oxides to be absorbed.

The venturi system operates with a pressure difference of 30 kPa in the first stage and 150 kPa in the second stage. The mist formed in the venturi washing process is trapped in a packed tower. This intensive gas purification produces waste gases that contain very pure  $\text{SO}_2$ , which can be used for sulfuric acid production [11]. The recovery of rhenium from the flue gases in the roasting of molybdenite is shown schematically in Figure 33.2.

The roasted molybdenum concentrates are used mainly to produce  $\text{MoO}_3$  for direct use in metallurgy (production of ferromolybdenum) and in molybdenum chemistry. For economic reasons, optimum conditions for rhenium recovery cannot always be maintained (temperature, air excess, etc.). The yield of rhenium is also limited by various impurities in the concentrates, especially alkali-metal and alkaline-earth elements, which form nonvolatile stable perrhenates under roasting conditions.

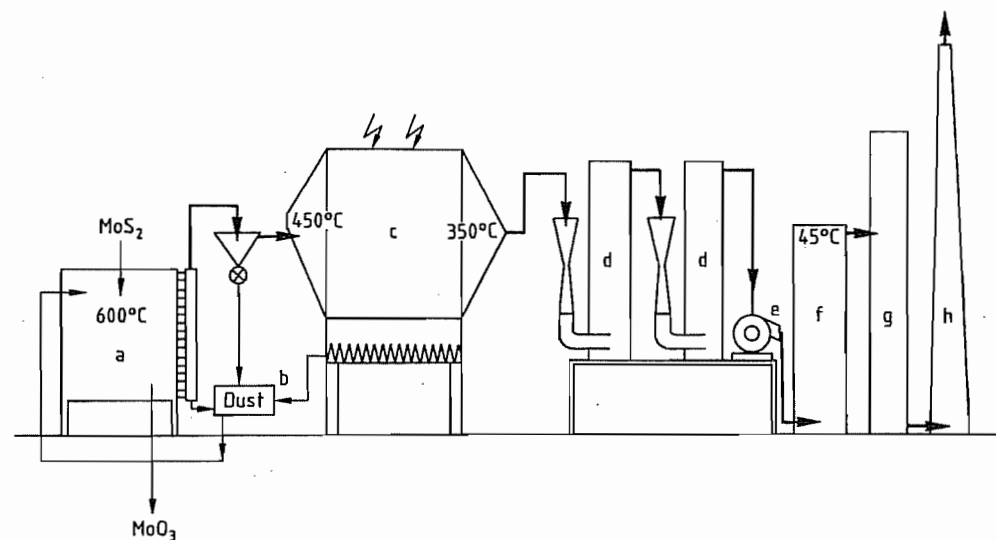

Figure 33.2: Flue gas purification with rhenium recovery by H. C. Starck: a) Roasting furnace; b) Dust chamber; c) Electrostatic filter; d) Venturi scrubbers; e) Ventilator; f) Secondary washer; g) SO<sub>2</sub> conversion; h) Stack.

Other possible processes for the treatment of molybdenum concentrates include electrooxidation [20] and treatment with O<sub>2</sub> or NH<sub>3</sub> at high temperature and pressure [21]. Yields of Mo and Re are ca. 98%. These processes have not been used thus far on an industrial scale.

### 33.4.2 Production of Pure Rhenium Compounds from Gas Scrubbing Solutions

Gas scrubbing solutions contain sulfuric acid and, typically, rhenium at 0.2–1.5 g/L. After removal of the solid constituents such as molybdenum oxides, sulfides, and selenium, rhenium can be precipitated as its sparingly soluble sulfide Re<sub>2</sub>S<sub>7</sub>, or by cementation on iron or zinc. It can then be concentrated further.

However, the use of ion exchangers in solid or liquid form is preferable for recovering and concentrating rhenium. Primary, secondary, and tertiary long-chain amines, dissolved in organic solvents such as kerosene, can be used to extract rhenium and molybdenum at pH 1–2. At higher pH, quaternary amines are more effective [22]. Separation of molybdenum

from rhenium can be achieved by extraction at an optimum pH. Alternatively, both elements can be extracted from acidic solution and then separated by selective stripping with ammonia at different pH values [23].

Rhenium in neutral, alkaline, or sulfuric acid solution can be fixed by strongly basic solid ion exchangers. The molybdate ion is less strongly bound to the ion exchanger than the perrhenate ion, enabling the molybdenum to be removed by a displacement reaction. Rhenium can be eluted from the ion-exchange resin by strong mineral acids, especially perchloric acid, or ammonium thiocyanate [24].

Technical-grade ammonium perrhenate is produced by crystallization from the eluate solution. Further purification is carried out by recrystallization.

Solvent extraction, combined with the use of solid ion exchangers or crystallization, can be used to produce pure or highly pure ammonium perrhenate, which is the starting material for the production of many rhenium compounds as well as the metal [25]. A schematic of rhenium production is given in Figure 33.3.

Another method of rhenium production consists of solvent extraction combined with

electrowinning of the rhenium from perchlorate solutions [26].

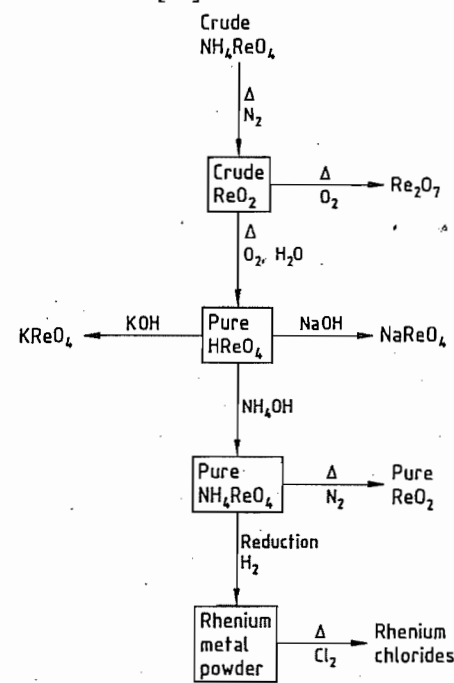

Figure 33.3: Rhenium production.

### 33.4.3 Production of Rhenium Metal Powder and Pellets

Rhenium powder can be produced by the reduction of pure ammonium perrhenate NH<sub>4</sub>ReO<sub>4</sub> in a stream of hydrogen. This reduction is usually carried out in two stages:

- Reduction at 300–350 °C to form ReO<sub>2</sub>
- Reduction of the ReO<sub>2</sub> to Re metal powder at 800 °C

The desired properties of the metal powder, such as grain size and surface area, can be achieved by adjustment of the reduction parameters.

In a further stage, the rhenium metal powder with added compaction agents is compressed into pellets and then sintered at ca. 1000–1500 °C under an atmosphere of hydrogen. To produce large workpieces, the powdered metal is charged into rubber containers, compressed isostatically at ca. 500 MPa, and

then sintered. Rhenium can be produced at almost its theoretical density by hot isostatic pressing (HIP) and by electron-beam or electric-arc melting.

Rhenium has very high strength at high temperature, as well as extremely good ductility and cold working properties. It is therefore a very useful high-temperature material. In some applications, the useful properties of rhenium can best be realized by chemical vapor deposition (CVD) [27]. Plasma coating with spheroidized rhenium metal powder is another possibility, producing dense rhenium coatings when combined with a sintering operation.

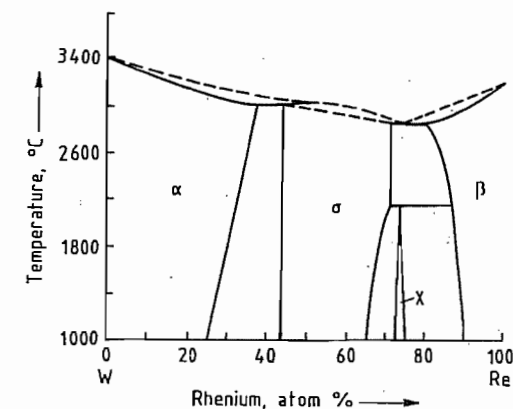

Figure 33.4: Tungsten-rhenium phase diagram [31].

### 33.5 Rhenium as an Alloying Component

When rhenium is used as an alloying component with the metals tungsten and molybdenum, which are difficult to work, ductility and strength are improved [28]. This is caused by alloy softening, which is defined as the reduction in the yield stress or hardness at low temperature. This effect is observed especially in body-centered cubic alloys. In addition to the improvement in ductility at low temperature, the strength at high temperature increases [29]. Tungsten rhenium alloys containing 25–30% Re have good cold ductility [30]. As indicated in Figure 33.4, rhenium is very soluble in tungsten, its solubility reaching 28% at

1600 °C and 37% at 3000 °C. Tungsten is also soluble in rhenium: 11% at 1600 °C and 20% at 2825 °C. Besides a tetragonal  $\sigma$ -phase, a cubic  $\chi$ -phase exists in a very narrow range in the W-Re system [31].

The poor welding properties of common molybdenum alloys limit their use in high-temperature applications. The addition of rhenium enables these alloys to be welded and used as construction materials. Molybdenum rhenium alloys containing up to 50% Re show high tensile strength and good elongation over the temperature range 0–1800 °C [32].

Superalloys must have not only high strength, but also good corrosion resistance at elevated temperature. They may be divided into three groups: nickel-base alloys, cobalt-base alloys, and iron (nickel)-base alloys.

Other typical alloying elements include chromium, molybdenum, tungsten, niobium, tantalum, aluminum, titanium, boron, and zirconium. The addition 1–3% Re to a nickel-base alloy improves its toughness at high temperature and prevents fatigue fracture [33].

## 33.6 Uses

Rhenium in the form of the powdered metal or pellets is incorporated into alloys by various methods. The W-Re and Mo-Re alloys are used mainly in the manufacture of thermo-elements. Other uses include semiconductors, heating elements, electrical and electronic applications, high-temperature welding rods, and metallic coatings [34].

Tungsten-rhenium alloys (W5Re, W10Re) are used in the manufacture of rotating X-ray anodes. For normal X-ray diagnosis, composite anodes, consisting of a very hard molybdenum base with an annular W-Re coating, are used. Computer tomography requires larger anodes, made by using a hybrid metal graphite construction combined with a W-Re coating [35]. An alternative technique is to deposit the metals or alloys by CVD or PVD processes [36].

Nickel-base alloys containing 1–3% Re are used mainly in the production of aircraft tur-

bine blades. They are monocrystalline and have high strength and resistance to oxidation. When these turbine blades are used in the hot zones of an engine, operating temperature can be increased, giving higher efficiency (lower fuel consumption). Similar effects are achieved by coating the gas turbine blades with rhenium-containing (1–20% Re) MCrAlY alloys [37].

## 33.7 Compounds

Rhenium closely resembles its neighbors in the sixth row (W, Os) and molybdenum (diagonal relationship) in its physical properties; many chemical parallels also exist. Eleven oxidation states of rhenium have been described [38]. In the most important rhenium compounds such as perrhenic acid, the perrhenates, and dirhenium heptoxide, rhenium has the oxidation state 7+. It exhibits its lowest oxidation states (as low as 3–) in carbonyl complexes.

### 33.7.1 Oxides and Chalcogenides

The yellow hygroscopic rhenium(VII) oxide,  $\text{Re}_2\text{O}_7$ , is the most stable oxide of rhenium. It is formed from rhenium metal powder or other rhenium oxides in dry air or an oxygen atmosphere above 350 °C. The oxide  $\text{Re}_2\text{O}_7$  is readily soluble in water, forming the colorless perrhenic acid,  $\text{HReO}_4$  which is pale yellow at high concentration.

Perrhenic acid forms salts ( $\text{MReO}_4$ ) with a tetrahedral  $\text{ReO}_4^-$  ion. Ammonium perrhenate,  $\text{NH}_4\text{ReO}_4$ , is an important starting material, which can be reduced to Re metal and used for the production of many other rhenium compounds. The preparation of some rhenium compounds is shown in Figure 33.5. When  $\text{Re}_2\text{O}_7$  is heated with rhenium powder, the oxides  $\text{ReO}_3$ ,  $\text{Re}_2\text{O}_5$ ,  $\text{ReO}_2$ , and  $\text{Re}_2\text{O}_3$  are formed.

In  $\text{Re}_2\text{O}_7$ ,  $\text{ReO}_4$  tetrahedra and  $\text{ReO}_6$  octahedra are linked alternately at their corners.  $\text{ReO}_3$  disproportionates on heating to form  $\text{Re}_2\text{O}_7$  and  $\text{ReO}_2$ . The bluish black rhenium(IV) oxide,  $\text{ReO}_2$ , which is insoluble in

water, has a distorted rutile structure and disproportionates at 900 °C into  $\text{Re}_2\text{O}_7$  and metallic Re.

With sulfur, rhenium forms  $\text{Re}_2\text{S}_7$ ,  $\text{ReS}_3$  and  $\text{ReS}_2$ . The black rhenium(VII) sulfide is formed when hydrogen sulfide is passed into acidic solutions of perrhenates. Reduction of  $\text{Re}_2\text{S}_7$  by hydrogen produces  $\text{ReS}_3$ . The most stable sulfide  $\text{ReS}_2$  is formed by the thermal decomposition of  $\text{Re}_2\text{S}_7$  or by heating the elements together. The structure of  $\text{ReS}_2$  (trigonal prismatic) is isomorphous with the rhombohedral modification of  $\text{MoS}_2$  [38].

Table 33.1 lists the properties of some oxides and sulfides of rhenium.

Ammonium perrhenate reacts with aqueous ammonium polysulfide to form  $(\text{NH}_4)_2(\text{Re}_2\text{S}_{16})$ , a polynuclear sulfide having a metal-metal bond with marked double-bond character [39].

### 33.7.2 Halides

The most important rhenium halides can be prepared from the elements (Figure 33.5). Rhenium(VII) fluoride,  $\text{ReF}_7$ , is the highest halide. It is formed at 400 °C under slight pressure.

**Table 33.1:** Properties of some rhenium oxides and sulfides [38].

Compound	mp/bp, °C	Structure	Oxidation state
$\text{Re}_2\text{O}_7$	300/360	alternating tetrahedra and octahedra	VII
$\text{ReO}_3$	> 300/750	cubic	VI
$\text{ReO}_2$	900 (decomp.) → $\text{Re}_2\text{O}_7 + \text{Re}$	rutile	IV
$\text{Re}_2\text{S}_7$	> 250 (decomp.) → $\text{ReS}_2 + \text{S}$		VII
$\text{ReS}_2$	1000 (decomp.) → $\text{Re} + \text{S}$	trigonal prismatic	IV

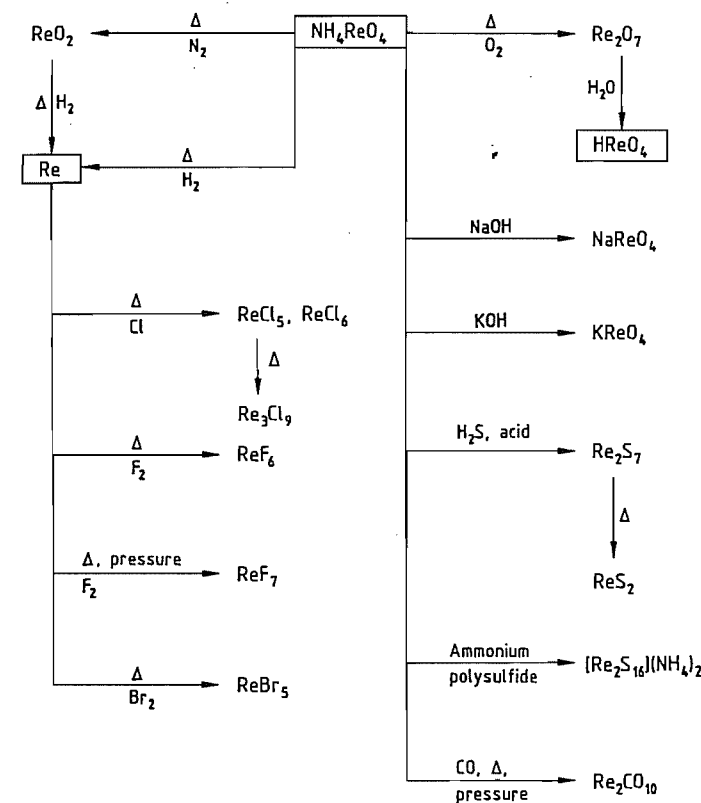

**Figure 33.5:** Synthesis of rhenium compounds.

Table 33.2: Rhenium halides.

Oxidation state	Fluorides	Chlorides	Bromides	Iodides
VII	ReF <sub>7</sub> yellow mp 48.3 °C bp 73.7 °C			
VI	ReF <sub>6</sub> yellow mp 18.5 °C bp 33.7 °C	ReCl <sub>6</sub> brown-green mp 29 °C		
V	ReF <sub>5</sub> yellow-green mp 48 °C bp 221 °C (extrapolated)	ReCl <sub>5</sub> black-brown mp 220 °C	ReBr <sub>5</sub> dark brown 110 °C (decomp.)	
IV	ReF <sub>4</sub> blue mp 124.5 °C sublimes 300 °C	ReCl <sub>4</sub> black-violet 300 °C (decomp.)	ReBr <sub>4</sub>	ReI <sub>4</sub> (decomp. > room temperature)
III		(ReCl <sub>3</sub> ) <sub>3</sub> dark red sublimes 500 °C (decomp.)	(ReBr <sub>3</sub> ) <sub>3</sub> red-brown	(ReI <sub>3</sub> ) <sub>3</sub> black (decomp. on heating)

Rhenium(VI) fluoride, ReF<sub>6</sub>, is formed from the elements at 125 °C. Rhenium(V) fluoride, ReF<sub>5</sub>, and rhenium(IV) fluoride, ReF<sub>4</sub>, can be prepared by reduction of ReF<sub>6</sub>. Suitable reducing agents include H<sub>2</sub>, metallic Re, SO<sub>2</sub>, and Zn.

Rhenium pentachloride, Re<sub>2</sub>Cl<sub>10</sub>, is an important starting material for the synthesis of other rhenium compounds. It is formed from the elements at 500 °C. In the crystal, ReCl<sub>6</sub> octahedra form edge-sharing dimers. Rhenium(III) chloride, Re<sub>3</sub>Cl<sub>9</sub>, can be produced by thermal decomposition of the pentachloride. All rhenium(III) chlorides, bromides, and iodides contain the Re<sub>3</sub>X<sub>9</sub> unit with Re<sub>3</sub> metal clusters.

ReBr<sub>3</sub> or ReCl<sub>3</sub> reacts with aqueous solutions of HBr to form ReBr<sub>3</sub>·<sup>2</sup>/<sub>3</sub>H<sub>2</sub>O. Single crystals can be obtained by evaporation of the solution [40]. Rhenium(IV) bromide, ReBr<sub>4</sub>, and ReI<sub>4</sub> are formed by the reaction of HReO<sub>4</sub> with HBr or HI.

Some properties of rhenium halides are given in Table 33.2 [38]. A large number of complex halides and oxyhalides of rhenium are known [41]. In the latter, rhenium is linked to oxygen by both single and double bonds. With nitrogen, triple, double, and single bonds are known [42].

### 33.7.3 Carbonyls

Rhenium carbonyl, Re<sub>2</sub>(CO)<sub>10</sub>, is formed by the reaction of CO with Re<sub>2</sub>O<sub>7</sub> or Re<sub>2</sub>S<sub>7</sub> at elevated pressure and temperature (20 MPa, 250 °C). It forms colorless crystals (mp 177 °C) and sublimes in vacuum. From the binary rhenium carbonyl, many cluster carbonyls, carbonyl hydrides, and complexes with a wide range of ligands in various oxidation states can be prepared [43].

## 33.8 Uses of Rhenium Compounds

Rhenium compounds are used in various areas of homogeneous and heterogeneous catalysis in petrochemistry, the pharmaceutical industry, and organic synthesis (e.g., alkylation, dehydroisomerization, dealkylation, isomerization, dehydrochlorination, hydrogenation, dehydrogenation, dehydrocyclization, oxidation, and reforming [44]).

Reforming is an important part of petroleum processing. It is used in the production of unleaded antiknock fuels for internal combustion engines and aromatic hydrocarbons for various syntheses [45]. Originally, molybdenum oxide was used for reforming, but it was soon found that platinum on aluminum oxide

(Al<sub>2</sub>O<sub>3</sub>) had better catalytic properties. An increase in catalytic activity, selectivity, and particularly stability was achieved with the development of platinum rhenium catalysts. The production of Pt-Re bimetallic catalysts by Chevron and UOP began in 1968 (Rheniform process). The rhenium components were solutions of NH<sub>4</sub>ReO<sub>4</sub> or HReO<sub>4</sub>. Today, multimetallic catalysts such as platinum rhenium indium have been developed from the earlier bimetallic catalysts [46]. The reforming process is still the most important catalytic application of rhenium compounds. In 1990, 45% of rhenium consumption in the United States was for this process [14].

New rhenium compounds such as methyltrioxorhenium, CH<sub>3</sub>ReO<sub>3</sub>, which can be produced fairly simply from Re<sub>2</sub>O<sub>7</sub> and tetramethyltin, exhibit catalytic activity in the synthesis of alkenes (alkene metathesis), alkene oxidation, and alkenation of aldehydes [47].

Basic research in the field of rhenium compounds is expected to lead to the discovery of further catalytic properties of known rhenium compounds and of compounds as yet undiscovered.

## 33.9 Analysis

The analytical chemistry of rhenium includes the determination of rhenium in raw materials and intermediates, and the determination of trace impurities in high-purity rhenium products.

Rhenium can be determined by various analytical methods after separation by selective precipitation, distillation, extraction, and ion exchange. W. GEILMANN and H. BODE carried out important research into the analysis of rhenium in the 1940s and 1950s [48]. The most important practical application is the rapid and convenient determination of small amounts of rhenium in the presence of large amounts of molybdenum, which invariably accompanies it. After treatment of a sample with alkali, rhenium is determined in the Re(VII) state as the perrhenate ion. The accompanying elements

are separated and masked, and Re(VII) is then precipitated by addition of the tetraphenylarsonium cation and determined gravimetrically [49]. In acidic solution in the presence of SnCl<sub>2</sub>, Re(VII) forms colored chelates with oximes and thiocyanates, which are extracted and determined by spectrophotometry [50]. Rhenium can be determined by atomic absorption spectrometry using the resonance line at 346.047 nm. Analysis of solutions by emission spectrometry uses the lines at 346.047 and 346.473 nm [51]. Polarographic methods are also available [52].

The determination of trace elements in high-purity rhenium products, such as NH<sub>4</sub>ReO<sub>4</sub> or rhenium metal, is carried out by combustion analysis (C), hot extraction by carrier gas (N, O), and atomic absorption spectroscopy on solutions (metallic impurities) [53].

## 33.10 Economic Aspects

The largest world reserves of rhenium are located in Chile which is today the world's largest producer. Other producers include Germany, CIS, Sweden, the United States, and Japan. In Germany, rhenium is obtained from molybdenum concentrates, spent catalysts, and rhenium-containing scrap, and processed to produce high-purity NH<sub>4</sub>ReO<sub>4</sub>, HReO<sub>4</sub>, and Re metal powder or pellets [54]. The largest consumer of rhenium is the United States, which imported ca. 15 t of Re in 1990. This could increase to 20 t/a in the next five years. Rhenium is used for aircraft turbine blades (60%), reforming catalysts (30%), and other applications (10%) [14].

## 33.11 Toxicology and Physiological Effects

No evidence exists that rhenium is an essential element for living organisms [55]. People who have worked over a long period of time in the extraction and production of rhenium metal and its most important compounds, perrhenic acid and ammonium

perrhenate, have not shown any toxic effects. Current toxicological investigations of rhenium and rhenium compounds are contradictory and do not enable any OECD guidelines to be issued [56].

Medical studies indicate that rhenium carboxylates have an antitumor effect [57]. <sup>188</sup>Rhenium and <sup>186</sup>rhenium are used in combination with monoclonal antibodies for the diagnosis and treatment of leukemia [58].

### 33.12 References

1. K. B. Lebedev: *The Chemistry of Rhenium*, Butterworths, London 1962.
2. R. D. Peacock: *The Chemistry of Technetium and Rhenium*, Elsevier, Amsterdam 1966.
3. B. W. Gosser (ed.): *Rhenium*, Elsevier, Amsterdam 1962.
4. A. Sutulov: Molybdenum and Rhenium 1778–1977, University of Concepción, Concepción, Chile 1976.
5. W. Noddack, I. Tacke, O. Berg, *Naturwissenschaften* **13** (1925) 567–574.
6. I. Noddack, W. Noddack, *Z. Anorg. Allg. Chem.* **183** (1929) 353–375.
7. W. Feit, *Angew. Chem.* **43** (1930) 459–462.
8. V. Tafel: *Lehrbuch der Metallhüttenkunde*, vol. 3, S. Hirzel, Leipzig 1954, pp. 224–230.
9. A. D. Melaven, J. A. Bacon, US 2414969, 1947.
10. S. Tribalat, *Anal. Chim. Acta* **3** (1949) 113–125; **4** (1950) 228–234.
11. H. G. Nadler, P. Borchers, *Erzmetall* **40** (1987) 293–298.
12. S. R. Zimmerley, E. E. Malouf, US 2809092, 1952.
13. H. Jehn, R. Völker, *Z. Metallkd.* **67** (1976) H. 11, 715–719.
14. J. W. Blossom: *Mineral Industry Surveys, Annual Review Rhenium in 1991*, U.S. Bureau of Mines, Washington, DC, 1992.
15. Universal Oil Products Comp., US 3672874, 1972 (C. L. Wiley, L. Blanchard). Amer. Cyanamid, US 4599153, 1986 (J. H. Bright).
16. Kennecott Corp., EP 0048823 A1, 1982 (P. Cichy).
17. M. J. Ferrante, F. E. Block, A. D. Fugate, F. A. Skirvin: Recovery of Rhenium from Tungsten–Rhenium Alloy, RI7254 U.S. Dept. of the Interior, Bureau of Mines, 1969.
18. GTE Products Corp., US 4557906, 1985 (A. D. Douglas, K. T. Reilly, J. E. Landmesser).
19. B. Jezowska-Trzebiatowska, S. Kopacz, T. Mikulski: *The Rare Elements*, Elsevier, Amsterdam 1990, p. 361.
20. B. J. Seheiner, R. E. Lindstrom, D. L. Pool: *Extraction and Recovery of Molybdenum and Rhenium from Molybdenite Concentrates by Electrooxidation: Process Demonstration*, RI8145, U.S. Bureau of Mines, 1976.
21. E. Gock, DE 3443806 A1, 1986.  
E. Gock, J. Friedrich, J. Kähler, DE 3710725 A1, 1988.
22. American Metal Climax Inc., DE 2045308, 1971 (C. J. Hallada, H. F. Barry, R. W. McConnell).
23. G. M. Ritcey, A. W. Ashbrook: *Solvent Extraction, Part II*, Elsevier, Amsterdam 1979, pp. 421–425.  
G. Huifa, Shell Jinglau, M. A. Hughes, *Hydrometallurgy* **25** (1990) 293–304.
24. J. Kähler, E. Gock, *Erzmetall* **41** (1988) no. 3, 132–137.
25. Kennecott Copper Corp., US 3558268, 1971 (J. D. Prater, R. N. Platzke).
26. H. G. Nadler, P. Borchers in GDMB Gesellschaft Deutscher Metallhütten- und Bergleute: *Die Anwendung von festen und flüssigen Ionenaustauschern bei der Gewinnung und Raffination von Metallen*, Heft 53, Clausthal-Zellerfeld 1989, pp. 162–174.
27. P. E. Churchward, J. B. Rosenbaum: *Sources and Recovery Methods for Rhenium*, RI6246, U.S. Bureau of Mines, 1963.
28. A. J. Sherman, R. H. Tuffias, R. B. Kaplan, *J. Met.* (1991) July, 20–23.
29. G. A. Geach, J. R. Hughes in F. Benesovsky (ed.): *The Alloys of Rhenium and Molybdenum or with Tungsten and Having good High-Temperature Properties*, *Plansee Proceedings*, Pergamon Press, London 1955, pp. 245–253.
30. E. Pink, R. J. Arsenault, *Prog. Mater. Sci.* **24** (1979) 1–52.
31. J. E. Peters, *J. of Met.* (1969) April, 27–30.
32. J. M. Dickinson, L. S. Richardson, *Trans. Am. Soc. Met.* **51** (1959) 758.  
S. V. Nagender Naidu, P. Rama Rao, *J. Alloy Phase Diagrams* **6** (1990) no. 3, 129–136.
33. R. Eck, *Int. J. Refract. HardMet.* **5** (1986) no. 1, 43–48.
34. General Electric Comp., EP 0403681 A1, 1990 (M. F. Henry).
35. H. Cross Comp.: *Rhenium and Rhenium Alloys*, Weekhawken, NJ.
36. H. Bildstein, BHM, *Berg Hüttenmänn. Monatsh.* **136** (1991) no. 9, 359–361.
37. Metallwerk Plansee, EP 0399621 A1, 1990 (P. Röthhammer).
38. Siemens AG, EP 0412397 A1, 1991 (N. Czech).
39. N. N. Greenwood, A. Earnshaw: *Chemistry of the Elements*, Pergamon Press, Oxford 1984.
40. A. Müller et al., *Angew. Chem.* **103** (1991) 1501–1503.
41. B. Jung, H. Ehrhardt, G. Meyer, *Z. Anorg. Allg. Chem.* **603** (1991) 49–56.
42. R. D. Peacock in J. C. Bailar, H. J. Emelius, Sir R. Nyholm, A. F. Trotman-Dickenson (eds.): *Comprehensive Inorganic Chemistry*, vol. 3, Pergamon Press, Oxford 1973, pp. 905–978.
43. K. Dehnicke, J. Strähle, *Angew. Chem.* **93** (1981) 451–463; **104** (1992) 978–1000.
44. F. A. Cotton, G. Wilkinson: *Anorganische Chemie*, VCH Verlagsgesellschaft, Weinheim 1985.
45. M. H. Corrigan, W. H. Davenport, J. W. Spelman: *A Bibliography on the Catalytic Applications of Rhenium*, Cleveland Refractory Metals, Weekhawken, NJ, 1968.
46. K. Weibermel, H. J. Arpe: *Industrielle Organische Chemie*, VCH Verlagsgesellschaft, Weinheim 1988, 334–337.
47. UOP Inc., US 4629551, 1986 (G. J. Antos, Li Wang).  
Exxon Research and Engineering Company, EP 0106531 B1, 1984 (G. E. Markley, W. E. Winter).
48. W. A. Herrmann et al., *Angew. Chem.* **103** (1991) 183–185, 1704–1711.
49. M. E. Peterson, J. S. MacDuff, M. W. Hovey: *Isolation and Colorimetric Determination of Rhenium*, RI5889, U.S. Bureau of Mines, 1961.
50. Gmelin, System no. 70, Rhenium, Verlag Chemie, Berlin 1941, 69–72.
51. O. G. Koch, G. A. Koch-Dedic: *Handbuch der Spurenanalyse*, part 2, Springer Verlag, Berlin 1974, 976–986.
52. O. D. Bozhkov, N. Jordanov, L. V. Borissova, Yu. I. Fabelinskii, *Fresenius Z. Anal. Chem.* **321** (1985) 453–456.
53. H. Y. Chen, R. Neeb, *Fresenius Z. Anal. Chem.* **320** (1985) 247–251.
54. N. Jordanov, I. Hazevov, O. Bozhkov, *Fresenius Z. Anal. Chem.* **335** (1989) 910–913.  
A. G. Khachatryan, *J. Planar Chromatogr.* **2** (1989) April, 142–147.
55. Roskill: *The Economics of Rhenium*, 4th ed., Roskill Information Services Ltd., London 1988, pp. 7–8.
56. P. Jacquet in H. G. Seiler, H. Sigel, A. Sigel (eds.): *Handbook on Toxicity of Inorganic Compounds*, Marcel Dekker, New York 1988, pp. 557–560.
57. J. T. Haley, F. D. Cartwright, *J. Pharm. Sci.* **57** (1968) 321–323.  
S. V. Suvorov, *Nov. Dannye Toksikol. Redk. Met. Ikh Soedin.* **1967**, 45–51; *Chem. Abstr.* **71** (1969) 53274h.
58. G. W. Estland, G. Yang, T. Thompson, *Methods Find. Exp. Clin. Pharmacol.* **5** (1983) no. 7, 435–438.
59. Sloan Kettering Inst. Cancer, US 450918, 1989 (D. A. Scheinberg).

## Part Eight

### Scattered Metals

																H	He				
Li	Be															B	C	N	O	F	Ne
Na	Mg	Al														Si	P	S	Cl	Ar	
K	Ca	Sc	Ti	V	Cr	Mn	Fe	Co	Ni	Cu	Zn	<b>Ga</b>	<b>Ge</b>	As	<b>Se</b>	Br	Kr				
Rb	Sr	Y	Zr	Nb	Mo	Tc	Ru	Rh	Pd	Ag	Cd	<b>In</b>	Sn	Sb	<b>Te</b>	I	Xe				
Cs	Ba	La <sup>†</sup>	<b>Hf</b>	Ta	W	<b>Re</b>	Os	Ir	Pt	Au	Hg	<b>Tl</b>	Pb	Bi	Po	At	Rn				
Fr	Ra	Ac <sup>‡</sup>																			

†	Ce	Pr	Nd	Pm	Sm	Eu	Gd	Tb	Dy	Ho	Er	Tm	Yb	Lu
---	----	----	----	----	----	----	----	----	----	----	----	----	----	----

‡	Th	Pa	U	Np	Pu	Am	Cm	Bk	Cf	Es	Fm	Md	No	Lr
---	----	----	---	----	----	----	----	----	----	----	----	----	----	----

For Hafnium and Rhenium, see *Refractory Metals*.

## 34 Germanium

JEAN SCOYER (§§ 34.1–34.11); FATHI HABASHI (§ 34.12); HANS UWE WOLF (§ 34.13)

34.1 Introduction .....	1505	34.7 Environmental Protection .....	1512
34.2 History .....	1505	34.8 Quality Specifications .....	1513
34.3 Physical Properties .....	1505	34.9 Chemical Analysis .....	1513
34.4 Chemical Properties .....	1506	34.10 Storage and Transportation .....	1514
34.5 Resources and Raw Materials .....	1507	34.11 Uses and Economic Aspects .....	1514
34.6 Production .....	1508	34.12 Compounds .....	1515
34.6.1 Production of Concentrates .....	1508	34.12.1 Germanium(IV) Compounds .....	1515
34.6.1.1 Bleiberger Bergwerks Union .....	1508	34.12.1.1 Germanium Hydrides .....	1515
34.6.1.2 Jersey Minière Zinc .....	1509	34.12.1.2 Polygermenes .....	1516
34.6.1.3 Musto Exploration .....	1509	34.12.1.3 Germanium(IV) Halides .....	1516
34.6.1.4 Peñarroya .....	1510	34.12.1.4 Germanium Dioxide, Germanic Acid, and Germanates .....	1517
34.6.1.5 Pertusola .....	1510	34.12.2 Germanium(II) Compounds .....	1518
34.6.1.6 Other Primary Producers .....	1510	34.13 Toxicology and Occupational Health .....	1518
34.6.2 Production of Germanium .....	1511	34.14 References .....	1519
34.6.3 Purification .....	1512		
34.6.4 Transformation Processes .....	1512		

### 34.1 Introduction

Germanium, a semiconducting element, has five natural isotopes:  $^{70}\text{Ge}$  (20.53%),  $^{72}\text{Ge}$  (27.43%),  $^{73}\text{Ge}$  (7.76%),  $^{74}\text{Ge}$  (36.54%), and  $^{76}\text{Ge}$  (7.76%). Germanium also has some radioactive isotopes with greatly different half-lives, the isotope with the longest half-life being  $^{68}\text{Ge}$  (287 days).

Germanium found its first industrial application in 1947 with the development of the transistor. Until the early 1970s, it was used extensively in the solid-state electronics industry, although it has been replaced almost entirely by the cheaper silicon.

The main use of metallic germanium currently is for infrared optics. Germanium tetrachloride is used in optical fiber production. Germanium dioxide is used mainly as a catalyst in the production of polyester and synthetic textile fiber.

The total consumption of germanium was estimated to be ca. 70 t of the element in 1986. The main producers of germanium end products are located in the United States, Belgium, France, Germany, and Japan.

Germanium is considered as a strategic material by the United States government. The erection of a stockpile with a capacity of 30 t of Ge was decided in 1984. The first delivery began in 1987 and the capacity may be increased to 140 t.

### 34.2 History

In 1871, MENDELEEV predicted the existence and the properties of an unknown element, ekasilicon, to be placed between silicon and tin in his periodic system of elements. In 1886, WINKLER isolated a new element from argyrodite,  $4\text{Ag}_2\text{S} \cdot \text{GeS}_2$ . This element, named germanium, showed properties remarkably close to those predicted by MENDELEEV.

### 34.3 Physical Properties

Although high-pressure polymorphs are known, germanium normally crystallizes in the diamond structure with comparatively weak covalent atomic bonding, yielding the typical hardness and brittleness, as well as the

semiconductor behavior of this gray amphoteric metal.

The specific structure of the forbidden energy gap (band gap  $E_g$ ), the binding forces between the germanium atoms, and their mass determine the major electron-photon and photon-phonon interactions in the crystal lattice, which result in a broad optical transmission range for infrared radiation. The fact that this range covers a main atmospheric transmittance window between 7 and 14  $\mu\text{m}$ , coinciding with the spectral emittance peak of a blackbody at room temperature, has promoted the use of germanium as an infrared optical material. Germanium's high refractive index results not only in high optical power and little spherical aberration, but also in the need for antireflection coatings. These materials often occur as exotic contaminants in recycling operations. Germanium's thermal properties sensitize this brittle material to thermal shock; crucible design and seeding techniques must also cope with a 6.6% volumetric expansion of germanium during solidification.

Due to the occurrence of a narrow band gap, most physical properties of germanium (e.g., resistivity) depend strongly on temperature as well as on minute concentrations of solutes. An updated and extensive compilation of the physical properties of germanium can be found in [1]; Typical room temperature values are summarized below.

Mechanical	
Lattice parameter	0.565790 nm
$mp$	1210.4 K
Density	5.3234 g/cm <sup>3</sup>
Microhardness (Vickers-ASTM E384)	780 kg/mm <sup>2</sup>
Tensile fracture strength	100 MPa
Electrooptical	
Band gap	0.67 eV
Intrinsic resistivity	47.6 $\Omega\text{cm}$
Transmission wavelength range	2–16 $\mu\text{m}$
Absorption coefficient at $\lambda = 10.6 \mu\text{m}$	0.02 cm <sup>-1</sup>
Refractive index at $\lambda = 10.6 \mu\text{m}$	4.0027
Thermal	
Thermal conductivity	0.586 W cm <sup>-1</sup> K <sup>-1</sup>
Specific heat	310 J kg <sup>-1</sup> K <sup>-1</sup>
Linear thermal expansion	$5.9 \times 10^{-6}$ K <sup>-1</sup>

## 34.4 Chemical Properties

[2, 3]

**Elemental Germanium.** Metallic germanium is stable in air. At temperatures above 400 °C in oxygen, a passivating oxide layer is formed. This layer is destroyed by water vapor.

Germanium resists concentrated hydrochloric and hydrofluoric acids even at their boiling points, but reacts slowly with hot sulfuric acid. The dissolution of germanium in nitric acid proceeds faster than in sulfuric acid. In alkaline media in the presence of an oxidizing agent, e.g., hydrogen peroxide, germanium dissolves rapidly, even at room temperature. Germanium reacts readily with halogens to form tetrahalides.

Germanium and silicon are totally miscible and form a continuous range of alloys. The system with tin has a eutectic.

**Germanium Compounds<sup>1</sup>.** Germanium can have valences of two or four. The divalent compounds are less stable and oxidize easily to the tetravalent compounds, which are similar to their silicon analogs.

**Germanium dioxide,** GeO<sub>2</sub>. Some properties of germanium dioxide are listed in Table 34.1. It exists in two crystalline forms and one amorphous form, all of which are white powders. The hexagonal form is obtained when germanium tetrachloride is hydrolyzed with water. This reaction leads to a voluminous gel that continuously releases its water during drying. The transformation to the tetragonal form occurs only on heating at 300–900 °C in the presence of a catalyst (e.g., an alkali metal halide).

The amorphous form is obtained by rapid solidification of molten GeO<sub>2</sub> or by reaction of GeCl<sub>4</sub> or GeO with oxygen in the gas phase. Moisture catalyzes the transformation from the amorphous to the hexagonal form.

**Germanium monoxide,** GeO, is obtained by the reaction of GeO<sub>2</sub> with reducing agents like germanium metal, iron, carbon, carbon mon-

<sup>1</sup> For more details, see Section 34.12.

oxide, or hydrogen above 600 °C. Germanium monoxide sublimes above 710 °C, and this property is used in some industrial processes to recover germanium from slags or residues (fuming of Ge). Germanium monoxide is insoluble in water.

Table 34.1: Properties of germanium dioxide.

Property	Structure		
	Hexagonal	Tetragonal <sup>a</sup>	Amorphous
Thermal stability, °C	1049–1116	< 1049	
Density at 25 °C, g/cm <sup>3</sup>	4.228	6.239	3.637
$mp$ , °C	1116	1086	
Solubility in water at 25 °C, g/L	4.53	insoluble	5.18
water at 100 °C, g/L	13	insoluble	
HF, HCl, NaOH	soluble	insoluble	soluble

**Germanium Halides.** Of the germanium halides, only germanium tetrachloride has practical applications. The properties of the tetravalent halides are listed in Table 34.2. Germanium tetrachloride is obtained by reaction of chlorine gas with germanium metal and of hydrochloric acid with GeO<sub>2</sub> or germanates. Germanium tetrachloride is soluble in carbon tetrachloride. Industrial practice takes advantage of the insolubility of GeCl<sub>4</sub> in concentrated HCl (> 6 M) to purify GeCl<sub>4</sub> from trace impurities such as As, Cu, and B by solvent extraction with HCl.

Table 34.2: Properties of germanium tetrahalides.

Property	GeCl <sub>4</sub>	GeF <sub>4</sub>	GeBr <sub>4</sub>	GeI <sub>4</sub>
Form at 25 °C	liquid	gas	crystals	crystals
Color	colorless	colorless	gray white	red
Density at 25 °C	1.8755			
$mp$ , °C	-49.5	-15	26.1	146
$bp$ , °C	83.2	-36.5 (sublimes)	186.5	348

**Germanium disulfide,** GeS<sub>2</sub>, is obtained by the action of H<sub>2</sub>S on acidic germanium solutions. Because GeS<sub>2</sub> is insoluble in acid media, this reaction is used industrially to obtain germanium concentrate.

**Germanates** are obtained in reactions at elevated temperature (800–1200 °C), in which glasses are produced from melts of GeO<sub>2</sub> and metal oxides or carbonates. The reactions also

occur at room temperature in aqueous solution; e.g., sodium germanate, Na<sub>3</sub>HGe<sub>3</sub>O<sub>16</sub>, is formed by treatment of a NaOH solution of GeO<sub>2</sub> with sulfuric acid.

**Germanides** can be produced by melting other metals with germanium and freezing the melt, e.g., Mg<sub>2</sub>Ge. Germanes (germanium hydrides) are evolved when germanides react with acids: monogermane, GeH<sub>4</sub>, digermane, Ge<sub>2</sub>H<sub>6</sub>, and trigermane, Ge<sub>3</sub>H<sub>8</sub>, can be separated by fractional distillation.

**Organometallic Compounds.** The organometallic compounds of germanium have few technical uses. Properties and methods of preparation have been extensively described [4].

## 34.5 Resources and Raw Materials [5, 6]

The concentration of germanium in the earth's crust averages 6.7 ppm, which is comparable to the concentration of zinc or lead. Thus, germanium is not scarce, but it is widely dispersed so that only a few minerals have been isolated. The most important are listed in Table 34.3.

Table 34.3: Germanium minerals.

Name and composition	Ge content, %	Mining location
Stottite, FeGe(OH) <sub>6</sub>	29	none
Schauerteite, Ca <sub>3</sub> Ge(SO <sub>4</sub> ) <sub>2</sub> (OH) <sub>6</sub> ·3H <sub>2</sub> O	14	none
Briarite, Cu <sub>2</sub> (Fe, Zn)GeS <sub>4</sub>	13–17	none
Germanite, Cu <sub>3</sub> (Ge, Fe)S <sub>4</sub>	5–10	Tsumeb, Namibia
Renierite, (Cu, Fe, Ge, Zn, As)S	6.3–7.7	Tsumeb, Namibia Kipushi, Zaire
Argyrodite, 4Ag <sub>2</sub> S·GeS <sub>2</sub>	1.8–6.9	Freiberg, Germany
Canfeldite, 4Ag <sub>2</sub> S·(Sn, Ge)S <sub>2</sub>		

Germanium is present in the lattices of certain sulfides, such as sphalerite. The concentration of germanium in some germanium-rich deposits is given in Table 34.4.



**Table 34.4:** Germanium content of diverse deposits.

Type	Location	Estimated Ge content, ppm
Zinc	Gordonville, Tennessee, USA	400
	Nanisivik, Baffin, Canada	230
	Saint-Salvy, France	150
	Tsumeb, Namibia	250
	Lyon Lake, Ontario, Canada	200–250
	Salafosa, Italy	200
	Bleiberg, Austria	200
Copper	Apex, Utah, USA	640
Coal	Northumberland, UK	300

In the past, germanite (Tsumeb) and renierite (Kipushi) were the principal sources of germanium. Currently, germanium is recovered mainly from by-products of the zinc industry.

The only mining operation specific for germanium (and Ga) is located at an old copper mine, the Apex, that has recently been reopened for this purpose.

At one time, germanium was recovered from the coal ash of electric power plants in England. This source of germanium vanished due to the decreased coal consumption for electric power production. The former Soviet Union, and probably China, still recover germanium from this source.

## 34.6 Production

The overall production processes can be divided into two steps: (1) production of germanium concentrate (primary production) and (2) production of germanium end products.

The first step varies depending on the raw materials processed and the chosen technology. Pyrometallurgical processes are based on the volatility of GeO and GeS. Hydrometallurgical processes are based on precipitation of germanium as its sulfide or hydroxide or with tannic acid.

More recently, solvent extraction has been reported using hydroxyoximes (e.g., LIX63), or oxime derivatives (e.g., Kelex 100, and LIX26) [7–18]. Fixation of germanium on resin impregnated with amines has also been patented [19]. However, published information on all of these is scarce and not always reliable.

The second step relies on the volatility of  $\text{GeCl}_4$  as the separation–purification step. Because the processes used by the diverse producers are quite similar, this step can be described with one flow sheet (Figure 34.6).

### 34.6.1 Production of Concentrates

The flow sheets for the production of germanium concentrate from germanite and renierite as raw materials have been described [20].

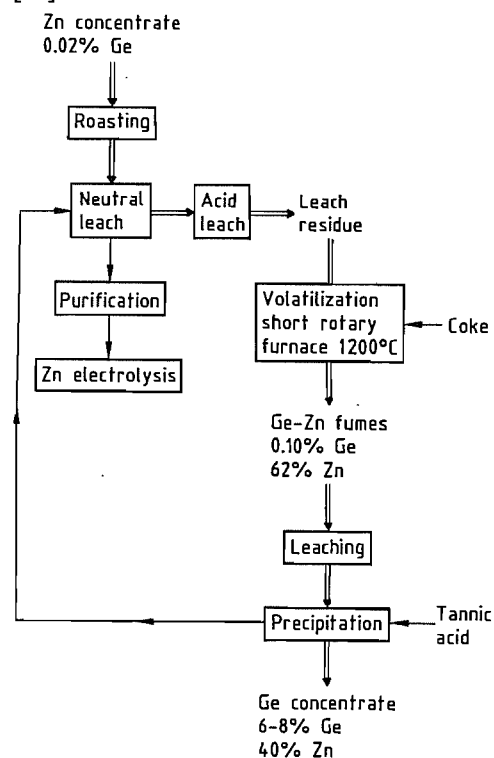

**Figure 34.1:** Production of a germanium concentrate: flow sheet of Bleiberg Bergwerks Union (BBU). Location: Arnoldstein, Austria; Bleiberg mine. Estimated Ge capacity: 6 t/a.

#### 34.6.1.1 Bleiberg Bergwerks Union

Bleiberg Bergwerks Union (BBU) processes the leach residues of its own zinc plant by a thermic process in a modified Waelz oven (Figure 34.1). Germanium monoxide is sub-

limed at ca. 1200 °C. After the fumes are leached, germanium is precipitated with tannic acid. The germanium-free solution is recycled to the zinc plant and the germanium concentrate is sold as such.

The use of tannic acid leads to a relatively poor germanium concentrate. Care must be taken to avoid problems in the zinc electrolysis due to the recycling of unreacted tannic acid [21–23].

#### 34.6.1.2 Jersey Minière Zinc

Jersey Minière Zinc produces zinc from its mines in Gordonville and Elmwood, Tennessee. Germanium is concentrated in the leach residue, which is dried and shipped to Metallurgie Hoboken-Overpelt (MHO), Belgium (Figure 34.2) [24].

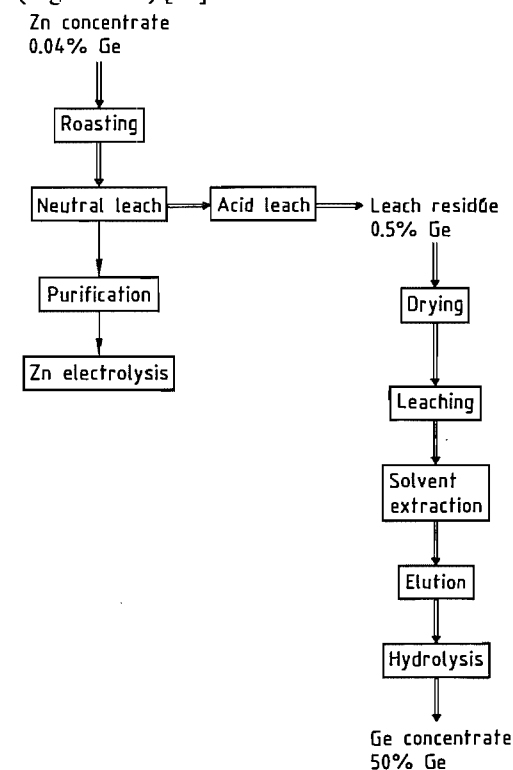
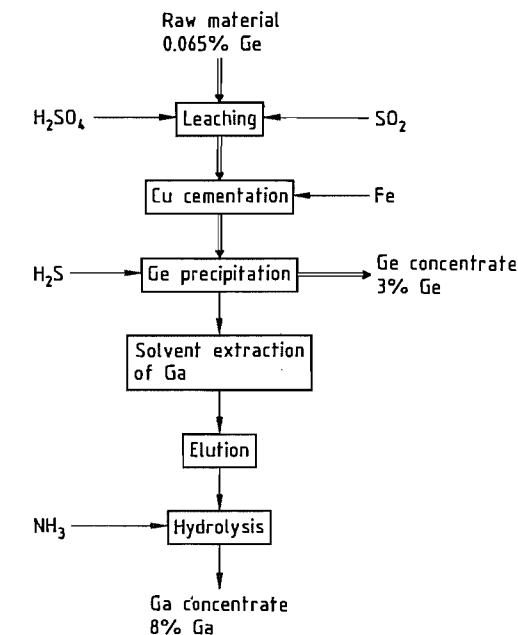

**Figure 34.2:** Production of a germanium concentrate: flow sheet of Jersey Minière Zinc (JMZ) and Metallurgie Hoboken-Overpelt (MHO). Location: JMZ at Clarksville, Tennessee, United States; Gordonville mine. MHO at Olen, Belgium. Estimated Ge capacity: 65 t/a.

At the Olen plant in Belgium, the germanium residue is leached, and germanium is separated by solvent extraction. After elution in an alkaline medium, a germanium concentrate is precipitated by hydrolysis [25]. The use of solvent extraction technology enables MHO to produce very rich germanium concentrates, regardless of the concentration in the feed [8–13].

#### 34.6.1.3 Musto Exploration

The Ge–Ga concentrates from the company-owned Apex mine are leached in sulfuric acid with  $\text{SO}_2$  to reduce trivalent iron (Figure 34.3). After cementation with iron to remove copper,  $\text{H}_2\text{S}$  is added to give a first sulfide concentrate. Gallium is then separated by solvent extraction. The germanium concentrate containing ca. 3% germanium is upgraded to  $\text{GeO}_2$  of 98% purity before being sold to refiners. Exploitation started in 1985 [26].



**Figure 34.3:** Production of a germanium concentrate: flow sheet of Musto Exploration. Location: St. George, Utah, USA; Apex mine. Capacity: 18 t/a of Ge and 10 t/a of Ga.

### 34.6.1.4 Peñarroya

Concentrates of Zn–Pb and germanium matte from Pertusola (Figure 34.5), a subsidiary of Peñarroya, are processed together by the Imperial Smelting Process. Germanium is collected in the zinc phase, which is further purified by distillation in New Jersey columns (Figure 34.4). Germanium is then concentrated in a residue by volatilization of zinc. However, due to ecological problems, thermal processes for zinc are losing importance compared with hydrometallurgical processes.

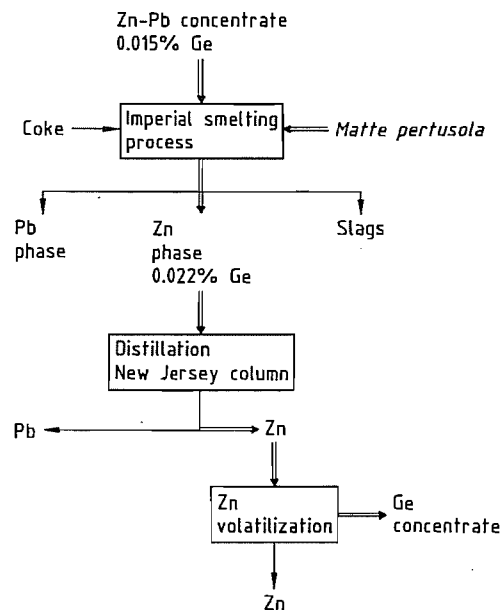

Figure 34.4: Production of a germanium concentrate: flow sheet of Peñarroya. Location: Noyelles-Godault, France; Saint-Salvy mine. Capacity:  $\text{GeO}_2$ – $\text{GeCl}_4$ , 60 t/a; Ge metal, 30 t/a.

### 34.6.1.5 Pertusola

The zinc concentrates of Salafosa are treated at the refinery of Crotona (Figure 34.5). The leach and purification residues of the hydrometallurgical plant are thermally decomposed in a cubilot. Germanium is recovered in the Pb–Zn fumes, a small portion going into the matte phase, which is processed further by Peñarroya (Figure 34.4). After re-

leaching the fumes, a germanium concentrate containing 7–35% germanium is produced.

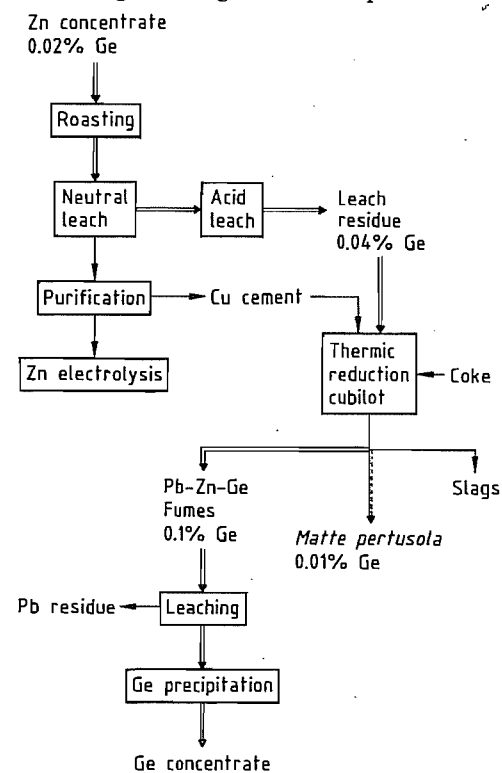

Figure 34.5: Production of a germanium concentrate: flow sheet of Pertusola. Location: Crotona, Italy; Salafosa mine.

### 34.6.1.6 Other Primary Producers

The Metallgesellschaft (Germany) recovers ca. 10 t/a of germanium from the hydrometallurgical plant of Datteln. China exports ca. 4 t/a of germanium. The production of the former Soviet Union is mainly used internally (estimated 40 t/a of germanium). Cominco (British Columbia, Canada) is developing a project for 10–20 t/a of germanium.

Eagle Picher (Quapaw, Oklahoma, USA) processed the residues of its zinc smelter by fuming in a Waelz oven at 1250 °C. Because this source is not economical at current prices, Eagle Picher now supplies its refining unit (25–40 t/a of germanium capacity) with purchased germanium concentrates [27]. Preus-

sag (15 t/a) and Otavi (5 t/a) (both Germany) processed germanite from Tsumeb before depletion, but they now buy concentrate [5].

### 34.6.2 Production of Germanium

The transformation of a germanium concentrate (mostly  $\text{GeO}_2$ ) or germanium metal scrap to germanium (Figure 34.6) [28] begins with conversion to  $\text{GeCl}_4$ :

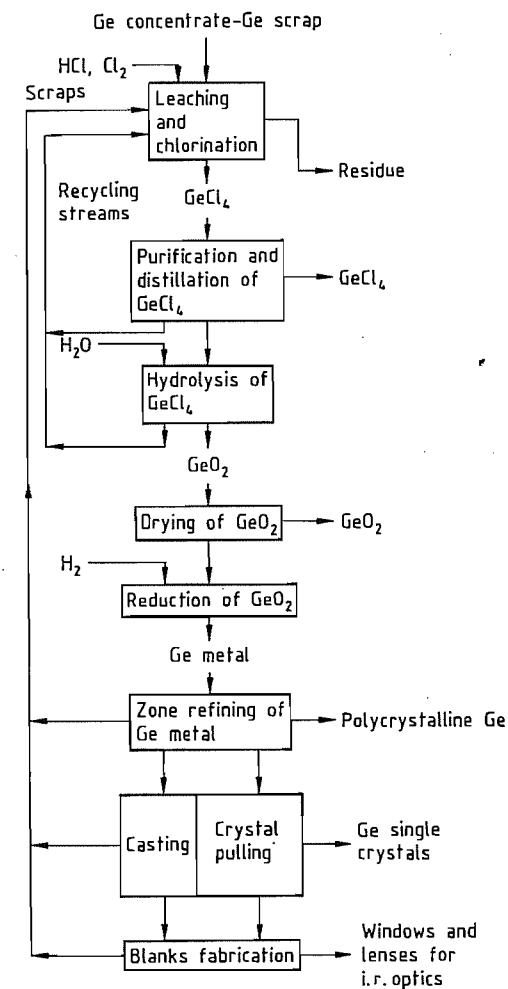
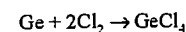
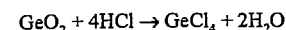
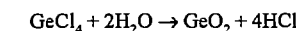

Figure 34.6: Flow sheet of the production of germanium metal from germanium concentrate.

The reactions are run at the boiling point of  $\text{GeCl}_4$  (83.2 °C) in concentrated HCl (6 M) to avoid hydrolysis. Even when only  $\text{GeO}_2$  is processed, a chlorine atmosphere is used to oxidize the volatile  $\text{AsCl}_3$  to nonvolatile  $\text{H}_3\text{AsO}_4$ .

The  $\text{GeCl}_4$ , containing  $\text{As}^{3+}$  as the major impurity, is purified by fractional distillation. Traces of As, Sb, Cu, and B are extracted by HCl (> 6 M) saturated with chlorine. Other purification techniques have been reviewed [20].

The purified  $\text{GeCl}_4$  is hydrolyzed with high-purity water,



After filtration and thorough washing, the  $\text{GeO}_2$  is dried.

The usual method of producing elemental germanium is hydrogen reduction [29] of germanium dioxide in electrically heated tubular furnaces at ca. 650 °C, yielding a gray metallic germanium sponge. In industry, graphite and/or quartz boats and furnace linings are used. Quartz boats must be sandblasted and/or coated to avoid sticking and breakage.

Care must be taken to keep the temperature below 700 °C during reduction to avoid generation of volatile germanium monoxide. Adequate processing limits the germanium loss to less than 0.1%.

As a result of the very stringent purity requirements, reduction processes [2] using carbon, flux electrolysis, or the direct reaction of germanium tetrachloride with zinc have lost industrial importance. The reaction of  $\text{GeCl}_4$  with  $\text{H}_2$  can be used to grow epitaxial germanium layers [30], but bulk germanium production is hampered by low metal yield and overall energy yield.

After complete reduction, the temperature is raised above the melting point (937 °C), and a polycrystalline germanium bar is solidified from one end to the other. Due to the different solubilities of the impurities in the liquid and solid phases, the impurities concentrate by segregation [31] in the first or the last melt fraction to solidify. Hydrogen is highly soluble in molten germanium; therefore, to avoid porosity and blow holes, the crystallization

speed must be limited to a few centimeters per hour.

### 34.6.3 Purification

To obtain semiconductor-grade germanium, the material must be further purified by zone refining [32, 33], under hydrogen, nitrogen, or another controlled atmosphere. Due to the low surface tension and high density of molten germanium, a crucible-free float zone-refining process never matured [34]. High-purity germanium is obtained by repeated passage of crude germanium through the zone-refining crucible. The number of efficient zone-refining passes which can be carried out in a single crucible is limited by the partition coefficient of the impurities between germanium and the crucible material. Eventually, an equilibrium between the concentration of impurities in the melt and in the crucible is reached. For this reason, a cyclic batch process, in which the zone refining is continued in a new crucible, is unavoidable if high-purity germanium is to be obtained. Between the successive refining steps, the less pure metal parts are mechanically cut away and recycled. A suitable etching technique [35] is required to clean and prepare the load as well as the crucible for the next refining step. Grain boundaries and other crystallographic imperfections (dislocations, vacancies, etc.) act as precipitation sites for impurities, impeding the ultrapurification.

Ultimate purity levels can therefore be obtained (and measured) only in single crystals grown in the most aseptic, dust-free environment. The physics and chemistry of ultrapurification of germanium have been discussed [36–38].

### 34.6.4 Transformation Processes

For most applications, the germanium must be processed further into a suitable size and crystallographic perfection and doped within a narrow range (e.g., 1–8 ppb) with a definite impurity (usually a group 13 or group 15 ele-

ment) to yield the specified electrooptical properties.

Two techniques are available for this transformation: (1) the *Bridgman process* [39] which entails horizontal or vertical, possibly seeded, directional solidification in a graphite crucible, often improperly called casting, and (2) the *Czochralski process* [40], by which a crystal seed is dipped into a germanium melt and allowed to grow by suitable control of pull speed and heat balance. The second process yields the most perfect material, e.g., dislocation-free single crystals. The fundamental physicochemical background of crystal-growth processes was reviewed recently [41–43]. Modern equipment handles up to 150-kg germanium loads and allows growth of single crystals up to 300 mm in diameter in a typical 48-h cycle.

Germanium crystals are ground, sliced, and milled with high precision microcomputer-controlled, diamond-tooled machines into the desired geometrical shape. This operation generates huge and costly amounts of scrap fines which have to be recycled. The brittleness of germanium and the need to preserve a near-perfect, strain-free crystal lattice do not allow germanium forging; segregation of the indispensable dopants hinders precision casting.

### 34.7 Environmental Protection

In the primary production of germanium, environmental problems are not specific to germanium, but are those of the zinc industry (e.g., SO<sub>2</sub> emission, cadmium pollution).

When solvent extraction units are used, special attention must be paid to fire protection and cleaning of the off-gas. The off-gas of GeCl<sub>4</sub> production must be scrubbed with alkaline solution to destroy HCl and chlorine. Monitoring the hydrogen content in the air avoids any risk of explosion in the reduction section.

### 34.8 Quality Specifications

Major impurities (< 10 ppm) in GeCl<sub>4</sub> are O, C, and H, all detectable by infrared spectrometry. The concentration of all metallic impurities can be depressed to or below their detection limits (typically < 5 ppb). Process-induced impurities in GeO<sub>2</sub> are H<sub>2</sub>O (< 3000 ppm, ASTM F5-60) and Cl (< 300 ppm, turbidimetry). Often, C, F, and S are detected at ppm levels (conductimetry); all other elements are at or below their detection limit (< 10 ppb).

Density (ASTM B417-76, B 527-70) and grain size (ASTM B 330-76) obviously influence reduction kinetics, but the contamination risks inherent to all high-temperature processes suggest the use of all-quartz furnaces and synthetic quartz boats with palladium-diffused H<sub>2</sub> for the assessment of electronic grade GeO<sub>2</sub> by reduction (ASTM F 27-83).

The most commonly used characterization techniques for germanium metal are those that determine the electrical properties of semiconductors: e.g., transport properties (ASTM F 43-78, F 76-73, F 42-77) and crystallographic perfection (ASTM F 389-76). For evaluation of the optical quality of germanium, a number of routine spectroscopic and specialized interferometric techniques exist [44]. All of these methods are, however, sensitive to the surface preparation (polishing) of the sample. Since many of the optical and electronic properties of germanium are linked to one another [45, 46], the electronic properties, which can be more accurately and reliably measured, can be used to define the optical properties. Thus, for example, standard optical grade germanium is specified as n-type germanium with resistivity 5–40 Ω cm.

To determine the chemical nature and concentration of electrically active impurities, three sensitive (10<sup>-5</sup> ppb) techniques are used: deep level transient spectroscopy (DLTS) [47], far infrared transmission (FIRT) [48] (Figure 34.7), and photothermal ionization spectroscopy (PTIS) [49].

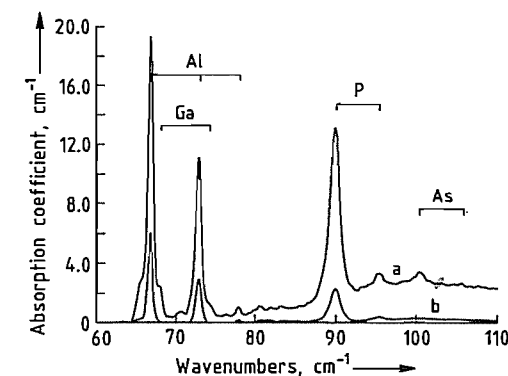

Figure 34.7: Purification by zone refining: a) 8K-FIRT spectra of germanium "as reduced" vs. b) after zone refining.

Impurity, ppb	"As reduced"	Refined
P	1.5	0.36
As	0.77	0.005
Al	1.1	0.27
Ga	0.031	0.005

The major residual impurities in high-purity germanium (H<sub>2</sub> < 100 ppb; C, Si, and O < 10 ppb) are process-induced and barely detectable by their lattice phonon absorption in the germanium matrix (ASTM F 120-75, F 122-74) or by autoradiospectrometry [50, 51]. The concentration of other impurities can be depressed below 10<sup>-3</sup> ppb.

### 34.9 Chemical Analysis

The analytical determination of germanium has been reviewed recently [52].

Germanium can be determined by photometry at 510 nm after complexation with phenylfluorone. Atomic absorption spectroscopy at 261.1 nm is less sensitive than the previous method. X-ray fluorescence enables determination down to 5 × 10<sup>-3</sup>%. Polarographic methods such as differential pulse polarography and anodic stripping have been developed for the determination of germanium (and other impurities) in Zn electrolytes.

The determination of impurities in GeCl<sub>4</sub>, GeO<sub>2</sub>, and Ge can be achieved by graphite furnace atomic absorption spectroscopy [53] or spark source mass spectroscopy [54].

## 34.10 Storage and Transportation

Germanium tetrachloride is classified as a dangerous corrosive liquid subject to international regulations (ADR/RID-IMDG-IATA) under UN 1760 Class 8 Group II. The combination of these with the very stringent purity requirements of the optical fiber manufacturers demands the use of expensive packaging (e.g., glass/teflon, tantalum-coated steel).

The packaging should preserve the purity of the  $\text{GeO}_2$  during transportation and storage. For relatively short storage, a hermetically sealed high-density polyethylene bottle is satisfactory. The quality degradation during longer storage is linked to diffusion of impurities through or deterioration of the polyethylene. In this case the use of fluorinated plastic foil or coating is advisable.

Germanium metal oxidizes slowly in air; therefore, its packaging should primarily take its brittleness into account.

## 34.11 Uses and Economic Aspects

Germanium is used in manufacturing a wide range of high-technology products. Table 34.5 summarizes these applications for the market economies with respect to market volume and trends, as well as the germanium compound used.

The use of germanium in *optical materials*, by far the most important today, represents ca. 50% of the world consumption. Germanium itself is the primary high-quality lens and window material for thermal imaging in the 8–12  $\mu\text{m}$  wavelength range. The materials trade-off for this application was recently reviewed [55]. The replacement of silicon by germanium as a cation in optical glasses [56] extends their transmittance toward longer wavelengths and increases the refractive index. The second property is used to confine the signal within the core of telecommunication optical fibers. The chemistry of germanium in fiber manufacture is discussed in [57]. With As, Sb, and

Se, germanium forms nonoxide glasses [58], also used in IR optics (Figure 34.8), and whose photosensitivity yields high-resolution photoresists, a recent development reviewed in [59].

**Table 34.5:** Germanium market in 1986 (excluding East-ern-bloc countries).

Application	Product	Consumption, t	Annual growth rate, %
Infrared optics	optical-grade Ge, shaped mono- and polycrystalline blanks	35	15
Optical fibers	high-purity $\text{GeCl}_4$	13	10
Catalysis	$\text{GeO}_2$ (hexagonal or amorphous), $\text{NaH}_2\text{Ge}_2\text{O}_6$	13	5
Electronics, optoelectronics	doped Ge single-crystal slices	2	5
High-energy radiation detectors	high-purity Ge single crystal	1	5
Luminescence	$\text{GeO}_2$	1	
Medical, alloys, and glasses	$\text{GeO}_2$ , Ge pellets, and powders	5	5
<b>Total</b>		<b>70</b>	<b>11</b>

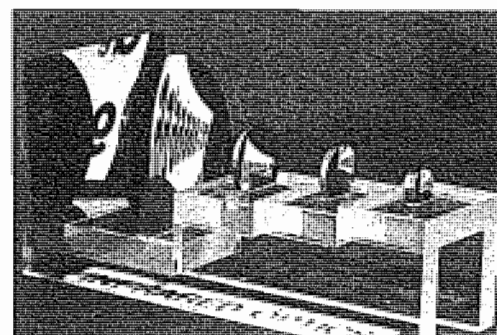

**Figure 34.8:** Germanium for infrared optics: typical set of polished Ge blanks.

The second major use of germanium is as *catalyst* or *cocatalyst* [60] in the production of polyesters (e.g., poly(ethylene terephthalate)) and synthetic textile fibers. The more expensive germanium catalysts are used when the final product must be a colorless fiber or plastic, e.g., photographic films.

Some germanates crystallize as typical *phosphors*, which reemit absorbed energy as

visible radiation. Magnesium germanates and fluorogermanates, e.g.,  $\text{Mg}_{28}\text{Ge}_{10}\text{O}_{48}$  and  $\text{Mg}_{56}\text{Ge}_{15}\text{O}_{66}\text{F}_{20}$ , in which magnesium acts as activator, are used in lamps as a constituent of the fluorescent coating [61]. This is preferred to the cheaper arsenic-based phosphors, for which safety regulations are severe. Bismuth germanate,  $\text{Bi}_4\text{Ge}_3\text{O}_{12}$ , is an intrinsic phosphor that is used as a single crystal in high-energy gamma-ray scintillator detectors [62]. The stopping power is extremely high because of the high atomic number of bismuth.

The remaining interest for germanium in electronics is based on the advantageous mobility characteristics of charge carriers in this material. Typical applications are high-power devices with low energy loss and photodetectors [63]. The most demanding photodetector application involves *gamma-ray spectroscopy detectors* [64], for which germanium must be refined to an extremely low impurity level ( $< 10^{-3}$  ppb) and grown in nearly perfect single crystals. Recent progress in producing stable insulating layers on germanium [65], as well as its crystal lattice match ( $\Delta a/a < 5 \times 10^{-3}$ ) with GaAs (epitaxy) offers new hope for germanium as an electronic material in integrated circuits.

Another use of germanium, although limited virtually to Japan, is the industrial production of organogermanium compounds such as bis(carbamoyl ethyl germanium) sesquioxide,  $(\text{GeCH}_2\text{CH}_2\text{CONH}_2)_2\text{O}_3$ , for medical applications [66]. The use of germanium in alloys, e.g., high-precision resistors, is minor. The geographic production consumption pattern for 1986 is summarized in Table 34.6.

In consideration of the large internal scrap recycling coefficient of most production lines, care should be taken in evaluating the apparent refining overcapacity of many producers.

**Table 34.6:** Production-consumption pattern for Ge in 1986.

Country	Production, t	Consumption, t
North America	29	35
Western Europe	36	18
Asia	5	17

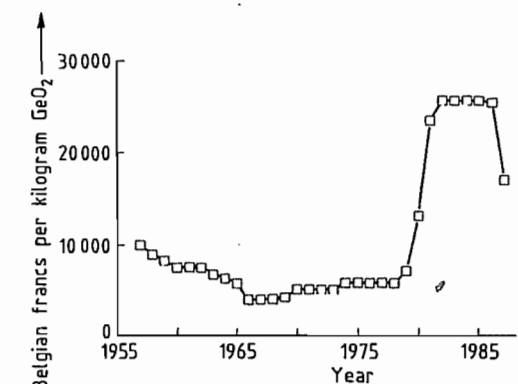

**Figure 34.9:** Belgian producer price for electronic-grade germanium dioxide (June 30 values from *Metal Bulletin*; the Belgian franc is the usual currency for the quotation of  $\text{GeO}_2$ ).

Figure 34.9 illustrates the producer price evolution of electronic-grade  $\text{GeO}_2$ , largely determined by the refining costs of low-grade ores. The price of germanium metal in its various commercialized forms reflects the stringent requirements for purity and crystallographic perfection and, therefore, depends strongly on the specifications.

## 34.12 Compounds [67, 68]

Halides, oxides and sulfides of both bivalent and quadrivalent germanium are known. The compounds of bivalent germanium are unstable. They have the tendency to be oxidized to germanium(IV) compounds.

### 34.12.1 Germanium(IV) Compounds

#### 34.12.1.1 Germanium Hydrides

If zinc is allowed to react with sulfuric acid which contains germanium, the escaping hydrogen contains some germanium hydride,  $\text{GeH}_4$ . If the gas mixture is passed through a strongly heated glass tube, the germanium is deposited on the wall as a bright metallic mirror, which appears red by transmitted light. Germanium hydride is obtained in good yield by the action of sulfuric acid on the alloy of composition  $\text{Mg}_2\text{Ge}$ , obtained when germa-

mium and magnesium are melted together. In addition to the ordinary gaseous germanium hydride (monogermane, *mp* -165 °C, *bp* -90 °C), formed as the main product, two germanium hydrides which are liquid at ordinary temperature are also formed:

- Digermane,  $\text{Ge}_2\text{H}_6$  (*mp* -109 °C, *bp* 29 °C)
- Trigermane,  $\text{Ge}_3\text{H}_8$  (*mp* -105.6 °C, *bp* 110.5 °C)

Monogermane is now prepared by the reduction of  $\text{GeCl}_4$  with  $\text{LiAlH}_4$  in ether:

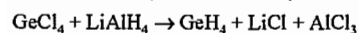

### 34.12.1.2 Polygermenes

In addition to these volatile compounds, germanium forms highly unsaturated solid hydrides:

- $[\text{GeH}]$ , a dark brown powder, which deflagrates upon admission of air when it is dry, is converted by oxidizing agents into germanium(IV) compounds, but does not react with dry hydrogen chloride.
- $[\text{GeH}_2]$ , obtained by decomposing  $\text{CaGe}$  with dilute hydrochloric acid or with caustic soda. It is yellow in color, stable in the absence of air when dry, but at once ignites explosively in the air. With concentrated hydrochloric acid, it forms the series of volatile germanium hydrides —  $\text{GeH}_4$ ,  $\text{Ge}_2\text{H}_6$ , and  $\text{Ge}_3\text{H}_8$  — together with  $\text{GeCl}_2$  and  $\text{H}_2$ .

### 34.12.1.3 Germanium(IV) Halides

Table 34.7 indicates the most important physical properties of the germanium(IV) halides.

Table 34.7: Germanium halides.

	Color	<i>mp</i> , °C	<i>bp</i> , °C
$\text{GeF}_4$	colorless	-36.6 (subl.)	
$\text{GeCl}_4$	colorless	-49.5	83.1
$\text{GeBr}_4$	colorless	26	186
$\text{GeI}_4$	orange	144	> 300

**Germanium Tetrafluoride.** The action of concentrated hydrofluoric acid on germanium dioxide yields a clear solution, from which colorless, hygroscopic crystals of hydrated germanium tetrafluoride,  $\text{GeF}_4 \cdot 3\text{H}_2\text{O}$ , sepa-

rate. If the attempt is made to dehydrate the salt by heating, hydrolytic decomposition takes place. Part of the germanium simultaneously volatilizes as the anhydrous fluoride. The anhydrous fluoride is gaseous at ordinary temperature. When strongly cooled, it condenses to a white flocculent mass which sublimes without melting when it is warmed.

**Potassium Fluorogermanate.**  $\text{K}_2[\text{GeF}_6]$  separates from a solution of germanium tetrafluoride to which potassium fluoride is added, in white hexagonal prisms or plates. It is not hygroscopic, sparingly soluble in cold water, insoluble in alcohol, and is decomposed when heated to a red heat.

**Germanium Tetrachloride.**  $\text{GeCl}_4$  made by burning germanium in a stream of chlorine, or better by warming germanium dioxide with fuming hydrochloric acid in a pressure flask. It is a colorless liquid, density 1.88, *bp* 83 °C, solidifying at -49.5 °C. It is slowly hydrolyzed by water, with the formation of hydrated, finely divided germanium dioxide. In its concentrated hydrochloric acid solutions, germanium tetrachloride is present in the form of chlorogermanic acid,  $\text{H}_2[\text{GeCl}_6]$ , as is shown by the migration of the germanium towards the anode upon electrolysis. If germanium tetrachloride is heated with germanium, it undergoes partial reduction of the dichloride:

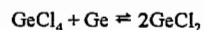

The compound  $[\text{GeCl}]_x$  is prepared by heating  $\text{GeCl}_4$ . The unstable  $\text{Ge}_2\text{Cl}_6$  is formed at the same time, and also the dichloride  $\text{GeCl}_2$ .

**Germanium Oxychloride.**  $\text{GeOCl}_2$  is a colorless liquid solidifying at -56 °C. It decomposes into  $\text{Cl}_2$  and  $\text{GeO}$  when it is heated. The  $\text{GeO}$  is thereby obtained in a lemon yellow form, which passes into the ordinary black monoxide at 650 °C.

$\text{Ge}_2\text{OCl}_6$  is obtained by the action of  $\text{O}_2$  on  $\text{GeCl}_4$  at 950 °C. It is a colorless liquid, solidifying at -60 °C, and decomposes with formation of  $\text{GeO}_2$  when it is warmed.

**Germanium Tetrabromide and Tetraiodide.** Germanium tetrabromide,  $\text{GeBr}_4$  (colorless regular octahedra, *d* 3.13, *mp* 26 °C, *bp* 185.9 °C), and germanium tetraiodide,  $\text{GeI}_4$  (orange crystals, *d* 4.32, *mp* 144 °C), can be prepared by methods similar to those for the chloride. They are vigorously decomposed by water and fume strongly in air. The iodide begins to decompose into  $\text{GeI}_2$  and  $\text{I}_2$  a little above its melting point.

### 34.12.1.4 Germanium Dioxide, Germanic Acid, and Germanates

**Germanium dioxide.**  $\text{GeO}_2$  is formed by strongly heating germanium or germanium sulfide in a current of oxygen, or by oxidizing these substances with concentrated nitric acid. It is a white powder which melts at 1115 °C after gradually softening, and solidifies from the melt as a glass. Germanium dioxide is volatile above 1250 °C. It is sparingly soluble in water (solubility about 0.4 g in 100 g of water at 20 °C, about 1 g in 100 g at 100 °C).

The solubility of germanium dioxide is dependent on the quantity of solid phase present. This is because germanium dioxide is present in solution not only in molecular dispersion, but simultaneously in a colloidal state. The formation of a sol also explains the fact that although the solubility in the cold is considerably smaller than when hot, no turbidity results when a solution of germanium dioxide, saturated hot, is cooled. The solutions display an acid reaction, and have an appreciable electrical conductivity. From dialysis measurements at a pH of 8.4–8.8 it was shown that the ions present were  $\text{Ge}_3\text{O}_{11}^{2-}$ , and not  $\text{GeO}_3^{2-}$  as in strongly alkaline solutions.

Germanium dioxide separates out in microscopic crystals when an aqueous solution is evaporated. It is dissolved with difficulty by acids, but readily by caustic alkalis. The compounds of germanium dioxide with strongly basic metallic oxides are called germanates; they can be obtained both from aqueous solution and by melting the components together, and display some relationships with the sili-

cates. The existence of germanates has been detected from melting point diagrams, e.g.,  $\text{Li}_4\text{GeO}_4$  (*mp* 1298 °C),  $\text{Li}_2\text{GeO}_3$  (*mp* 1239 °C),  $\text{Na}_2\text{GeO}_3$  (*mp* 1083 °C),  $\text{Na}_2\text{Ge}_2\text{O}_5$  (*mp* 799 °C),  $\text{Na}_2\text{Ge}_4\text{O}_9$  (*mp* 1052 °C). Metagermanates — mostly as hydrates — usually crystallize from aqueous solutions.

Germanium dioxide crystallizes not only in the water-soluble, hexagonal modification, having the low-quartz structure (*a* = 4.97 Å, *c* = 5.65 Å), but also in a tetragonal modification, insoluble in water, with the structure of rutile (*a* = 4.39 Å, *c* = 2.86 Å). This changes extremely slowly into the hexagonal modification above 1033 °C.

If germanium dioxide is prepared by hydrolysis, e.g., of the tetrachloride, it separates out as a gel. The particles of oxide gradually undergo aggregation on standing under water. If it has aged sufficiently, the oxide loses its water on standing in air.

**Germanium Disulfide and Thiogermanates.** If hydrogen sulfide is passed into an aqueous solution of germanium dioxide, no precipitation is observed. Only when a sufficient quantity of a strong acid has been added is germanium disulfide,  $\text{GeS}_2$ , formed as a white precipitate. The sulfide low solubility in water (0.455 g in 100 g of water); its aqueous solution gradually decomposes, hydrogen sulfide being evolved by hydrolysis:

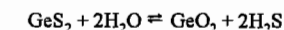

The disulfide dissolves readily in ammonium sulfide, forming thiogermanate ions:

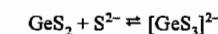

The thiogermanates are related to the naturally occurring double sulfides of germanium, the minerals germanite,  $\text{Cu}_3(\text{Fe}, \text{Ge})\text{S}_4$  argyrodite,  $\text{Ag}_8\text{GeS}_6$ , and canfieldite,  $\text{Ag}_8(\text{Ge}, \text{Sn})\text{S}_6$ .

**Germanium(IV) sulfate.**  $\text{Ge}(\text{SO}_4)_2$ , obtained as a white powder of density 3.92 by the action of  $\text{SO}_3$  on  $\text{GeCl}_4$ . It is hydrolyzed by water, reacts vigorously and exothermically with caustic soda forming  $\text{Na}_2\text{GeO}_3$  and  $\text{Na}_2\text{SO}_4$ , and decomposes at 200 °C.

### 34.12.2 Germanium(II) Compounds

**Germanium(II) chloride**,  $\text{GeCl}_2$ , is formed by passing  $\text{GeCl}_4$  vapor over heated elemental germanium. It is a solid, reacts with water according to:

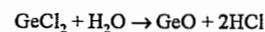

and with oxygen:

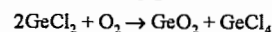

$\text{GeCl}_2$  is nearly colorless when cold, but turns orange when warmed. Decomposition occurs on stronger heating:

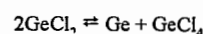

**Trichlorogermane**,  $\text{GeHCl}_3$ , corresponds in composition to chloroform, and resembles it in many of its physical properties. The compound was first obtained by passing hydrogen chloride over heated powdered germanium:

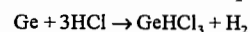

A better process is to pass  $\text{GeCl}_4$  over heated germanium, and to treat the product, consisting chiefly of  $\text{GeCl}_2$ , with HCl:

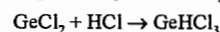

Trichlorogermane forms a colorless liquid, which turns milky on exposure to air, through the formation of oxychloride; *mp*  $-71^\circ\text{C}$ , *bp*  $75.2^\circ\text{C}$ . Germanium must be present in this compound in the bivalent state, for it is decomposed by much water, depositing yellow germanium(II) oxide hydrate.

**Germanium(II) bromide** (colorless needles or leaflets, *mp*  $122^\circ\text{C}$ ) can be obtained by the action of HBr on metallic germanium at  $400^\circ\text{C}$ ;  $\text{GeHBr}_3$  is formed simultaneously, and may be reduced with zinc. The dibromide is hydrolyzed by water, with deposition of  $\text{Ge}(\text{OH})_2$ .  $\text{GeBr}_2$  combines with HBr, to form tribromogermane,  $\text{GeHBr}_3$ , a colorless liquid, solidifying at  $-24.5^\circ\text{C}$  which decomposes again at high temperature.



**Germanium(II) iodide**,  $\text{GeI}_2$ , (yellow hexagonal plates; crystal structure, sublimes at  $240^\circ\text{C}$  in vacuum) is prepared by the action of

concentrated hydriodic acid on  $\text{Ge}(\text{OH})_2$ . It is obtained only in poor yield by passing  $\text{GeI}_4$  vapor over heated Ge, since it disproportionates according to

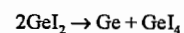

**Germanium(II) Oxide**. The decomposition of germanium(II) chloride with water or sodium hydroxide yields a yellow precipitate. If the precipitate is heated to  $650^\circ\text{C}$  in nitrogen, black crystalline germanium(II) oxide,  $\text{GeO}$ , is obtained.

**Germanium(II) sulfide**,  $\text{GeS}$ , can be obtained, by heating germanium(IV) sulfide,  $\text{GeS}_2$ , in a stream of hydrogen. It forms leaflets, which are grey with metallic luster by reflected light, and bright red by transmitted light. It is thrown down as a red brown precipitate by the action of hydrogen sulfide on the hydrochloric acid solution of germanium(II) chloride. It is then soluble in caustic potash and, unlike the sulfide prepared by dry methods, also dissolves in hot concentrated hydrochloric acid and in ammonium polysulfide.

**Germanium Selenides**.  $\text{GeSe}$  (brown-black, tetragonal, density 5.30, *mp*  $667^\circ\text{C}$  and  $\text{GeSe}_2$  (yellow, rhombic, density 4.56, *mp*  $70^\circ\text{C}$ ) have been prepared like the sulfides, by precipitation from hydrochloric acid solutions, or by direct union of the components at  $500^\circ\text{C}$ .

### 34.13 Toxicology and Occupational Health

Germanium and most germanium compounds are comparatively low in toxicity because of pharmacological inertness, diffusibility, and rapid excretion. However, some exceptions exist, the most important being germanium hydride (germane). Surprisingly, soluble germanium compounds are more toxic by oral than by parenteral uptake. Intoxication is characterized by a lack of gross tissue changes in animals dying from oral uptake of germanium. Industrial exposure is due mainly to germanium fumes and dusts generated during production.

**Absorption, Metabolism, Excretion, and General Effects**. Gastrointestinal absorption of germanium oxides and cationic salts is poor; in contrast, the absorption of germanates from small oral doses is ca. 75% in 4 h and 96% in 8 h [69]. Inhaled germanates are quickly absorbed from the lungs into the blood [70]. Elemental germanium and germanium dioxide are excreted mainly via the urine in rats, rabbits, and dogs [71]. No reports of Ge accumulation in human or animal tissues exist. High exposure levels of germanium salts disturb water balance leading to dehydration, hemoconcentration, decrease in blood pressure, and hypothermia [72], without showing gross tissue damage.

**Acute Toxicity**. The symptoms of acute germanium toxicity in animals are listlessness, marked hypothermia, diarrhea, cyanosis, edema, hemorrhage of the lungs, petechial hemorrhage in the wall of the small intestine, peritoneal effusion, and edematous changes in heart muscle and in parenchymal cells of the liver and kidneys [73]. Germanium tetrafluoride and tetrachloride vapors irritate the eyes and mucous membranes of the respiratory tract [74]. Organic compounds, such as dimethylgermanium oxide, are only slightly toxic to rats [75], whereas triethylgermanium acetate shows considerable toxicity [76]. Germanium metal dust (particle size  $1.7\ \mu\text{m}$ , concentration unknown) and  $\text{GeO}_2$  (particle size  $0.45\ \mu\text{m}$ , concentration unknown) had no adverse effects on rats after inhalation for 1 h [70]. In rats and mice, the acute oral toxicity of alkylgermanium compounds ranged between 300 and 2870 mg/kg [76, 77]. Triethylgermanium acetate has an  $\text{LD}_{50}$  value (rat, oral) of 250 mg/kg body weight. The  $\text{LD}_{100}$  for germane (mouse, inhalation) is  $610\ \text{mg}/\text{m}^3$  [69].

Germanium hydride,  $\text{GeH}_4$ , is a colorless, highly inflammable, toxic gas of low stability with a characteristic unpleasant odor. By inhalation, gaseous germanium hydride is the most toxic of germanium compounds. Inhalation of  $\text{GeH}_4$  ( $70\ \text{mg}/\text{m}^3$ , minimally effective concentration) for 2–15 d caused nonspecific and nonpersistent changes in the nervous system,

kidneys, and blood composition. Like other metal hydrides such as  $\text{AsH}_3$ , it shows hemolytic action in animals [78]. The lethal concentration in air is 150 ppm [79].

**Chronic Toxicity**. Symptoms of chronic germanium intoxication in experimental animals are mainly fatty degeneration of the liver and inhibition of growth: 1000 ppm neutralized  $\text{GeO}_2$  (pH adjusted to 7) given in the diet of rats for 14 weeks depressed growth and caused 50% mortality; 5 ppm germanium administered as germanates in the drinking water of rats and mice resulted in decreased lifespan and mild fatty degeneration of the liver; 100 ppm  $\text{GeO}_2$  in the drinking water for 4 weeks caused 50% mortality without hematological or gross pathological changes.

**Exposure Limits**. A TLV for germane of 0.2 ppm, equivalent to  $0.64\ \text{mg}/\text{m}^3$ , was fixed by the TLV Committee of the American Conference of Governmental Industrial Hygienists in 1973 as an average limit of permissible exposure during an 8-h working day. No other TLVs for germanium or its compounds have been set in industrialized countries. Neither germanium nor its compounds are considered or suspected to exert a carcinogenic effect on humans or animals [80].

### 34.14 References

1. Landolt-Börnstein, **GIII**, 17a (1982) 87–126, 400–433.
2. Gmelin, System No. 45, Germanium Supplement Volume, 1958.
3. Kirk Othmer, 3rd ed. 11, pp. 791–802.
4. M. Lesbre, P. Mazerolles, J. Satge: *The Organic Compounds of Germanium*, J. Wiley & Sons, London 1971.
5. Roskill: *The Economics of Germanium*, 4th ed., Roskill Information Service Ltd., London 1984.
6. U.S.B.M., Minerals Yearbooks, U.S. Dept. of the Interior, Washington.
7. G. Cote, D. Bauer, *Hydrometallurgy* 5 (1980) 149–160.
8. A. De Schepper, *Hydrometallurgy* 1 (1976) 291–298.
9. MHO, US 3883634, 1975 (A. De Schepper, A. Van Peteghem).
10. MHO, US 4432951, 1984 (A. De Schepper, M. Coussement, A. Van Peteghem).
11. MHO, US 4432952, 1984 (A. De Schepper, M. Coussement, A. Van Peteghem).

12. MHO, EP 68540 B1, 1983 (A. De Schepper, M. Coussemont, A. Van Peteghem).
13. MHO, EP 68541 B1, 1983 (A. De Schepper, M. Coussemont, A. Van Peteghem).
14. Peñarroya, US 4389379, 1983 (D. Bauer, G. Cote, P. Fossi, B. Marchon).
15. Peñarroya, US 4568526, 1986 (G. Cote, P. Fossi, B. Marchon, D. Rouillard).
16. Peñarroya, EP-A 46437 A1, 1981 (D. Rouillard, G. Cote, P. Fossi, B. Marchon).
17. Peñarroya, EP-A 167414 A1, 1986 (D. Bauer, G. Cote, B. Marchon).
18. Preussag, DE-OS 3508041 A1, 1986 (K. Hanusch, W. Krajewski).
19. Cominco, US 4525332, 1985 (D. L. Ball, D. A. D. Boateng, G. M. Swinkels).
20. Ullmann, 4th ed., 12, 221-226.
21. P. Müllner, *Erzmetall* 30 (1977) no. 7/8, 326-329.
22. F. Hilbert, F. Stary, *Erzmetall* 35 (1982) no. 4, 184-189.
23. F. Stary, *Erzmetall* 35 (1982) no. 6, 311-313.
24. L. A. Painter, *Eng. Min. J.*, July 1980, 65-88.
25. I. de Ruijter, *Photonics Spectra* 21 (1987) no. 7, 55-59.
26. J. L. Hopkins, *Can. Metall. Bull.* 78 (1985) no. 879, 86-87.
27. P. B. Queneau, P. Avotins, L. Farais, *Can. Metall. Bull.* 79 (1986) no. 886, 92-97.
28. J. E. Hoffmann, *J. Met.* 6 (1987) 42-45.
29. R. Hasegawa, *Trans. Nat. Res. Inst. Metals (Jpn.)* 20 (1978) no. 2, 111-127.
30. V. J. Silvestri, *J. Electrochem. Soc.* 116 (1969) no. 1, 81-87.
31. V. N. Vigdorovich: *Purification of Metals and Semiconductors by Crystallisation*, Freund Publ. House, Tel Aviv 1971.
32. W. G. Pfann: *Zone Melting*, J. Wiley & Sons, New York 1958.
33. K. Hein, E. Buhrig: *Kristallisation aus Schmelzen*, VEB Deutscher Verlag für Grundstoffindustrie, Leipzig 1983.
34. A. F. Bogenschütz: *Ätzpraxis für Halbleiter*, Hause Verlag, München 1967.
35. P. J. Holmes: *The Electrochemistry of Semiconductors*, Academic Press, London 1962.
36. E. E. Haller, W. L. Hansen, F. S. Goulding, *Adv. Phys.* 30 (1981) no. 1, 93-138.
37. L. S. Darken, *J. Electrochem. Soc.* 126 (1979) no. 5, 827-833.
38. L. S. Darken, *IEEE Trans. Nucl. Sci.* NS 26 (1979) no. 1, 324-333.
39. P. W. Bridgman, *Proc. Am. Acad. Arts Sci.* 60 (1925) 305.
40. J. Czochralski, *Z. Phys. Chem.* 92 (1917) 219-221.
41. F. Rosenberger: *Fundamentals of Crystal Growth*, (Solid State Science no. 5) Springer Verlag, Berlin-Heidelberg-New York 1979.
42. J. C. Brice: *Crystal Growth Processes*, Blackie, Glasgow 1986.
43. A. A. Chernov, *Modern Crystallography III, Crystal Growth* (Solid State Science no. 36) Springer Verlag, Berlin 1984.
44. J. A. Savage, *Proc. SPIE Int. Soc. Opt. Eng.* 274 (1981) 175-179.
45. C. J. Hutchinson, C. Lewis, J. Savage, A. Pitt, *Appl. Opt.* 21 (1982) no. 8, 1490-1495.
46. L. Van Goethem, L. P. Van Maele, M. Van Sande, *Proc. SPIE Int. Soc. Opt. Eng.* 683 (1986) 160-165.
47. E. Simoen, P. Clauws, J. Vennik, *J. Phys. D:* 18 (1985) 2041-2058.
48. E. Rotsaert, P. Clauws, J. Vennik, L. Van Goethem, *Proc. Int. Conf. Shallow Impurity Centers, 2nd, Trieste* (1986).
49. G. Bambakidis, G. J. Brown, *Phys. Rev. B Condens. Matter* 33 (1986) no. 12, 8180.
50. E. Haller, W. Hansen, P. Luke, R. Murray, B. Jarrel, *IEEE Trans. Nucl. Sci.* NS 29 (1982) no. 1, 738-744.
51. W. Hansen, E. Haller, P. Luke, *IEEE Trans. Nucl. Sci.* NS 29 (1982) no. 1, 745-750.
52. G. Henze, *Fresenius Z. Anal. Chem.* 324 (1986) 105-110.
53. Y. A. Zololov, M. Grosserbauer, C. H. Morrison, Y. Karpov, *Pure Appl. Chem.* 57 (1985) no. 8, 1133-1152.
54. C. Verlinden, R. Gybels, F. Adams, *J. Anal. Atom. Spectr.* 1 (1986) 411-419.
55. J. A. Savage: *Infrared Optical Material and Their Antireflection Coatings*, Adam Hilger, Bristol 1985.
56. S. Musikant: *Optical Materials*, Dekker, New York 1985.
57. D. L. Wood, Kr. Walker, J. B. Macchesney, J. R. Simpson, R. Csencsits, *J. Lightwave Technol.* LT 5 (1987) no. 2, 277-285.
58. D. Hamed, G. Tilloca, *Proc. SPIE Int. Soc. Opt. Eng.* 400 (1983) 44-49.
59. G. Frischat, *Proc. SPIE Int. Soc. Opt. Eng.* 400 (1983) 73-77.
60. P. Hugget, H. Lehmann, *J. Electron. Mater.* 14 (1985) no. 3, 205-230.
61. K. Wolf, B. Küsters, H. Helinger, C. Tchang, E. Schollmeyer, *Angew. Macromol. Chem.* 68 (1978) 23-27.
62. K. Butler: *Fluorescent Lamp Phosphors*, The Pennsylvania State Univ. Press, Pennsylvania 1980.
63. A. Horowitz, G. Kramer, *J. Cryst. Growth* 78 (1986) 121-128; 79 (1986) 296-301.
64. J. I. Pankove: *Optical Processes in Semiconductors*, Prentice Hall, Englewood Cliffs, NJ, 1971.
65. M. Van Sande, L. Van Goethem, H. Guislain, *Erzmetall* 38 (1985) no. 12, 588-593.
66. O. J. Gregory, E. C. Tisman, *Symposium on Integrated Circuit Fabrication and Technology* (Am. Chem. Soc.) 1984.
67. K. Asai: *Organic Germanium, A Medical Godsend*, Kogakusha, Tokyo 1977.
68. Gmelin Handbook of Inorganic Chemistry, System No. 45: Germanium, supplement volume, Springer Verlag, Berlin 1958.
69. H. Remy, *Lehrbuch der anorganischen Chemie*, volume 1, Akademische Verlagsgesellschaft, Leipzig 1965, pp. 637-643.
70. B. Venugopal, T. D. Luckey: "Metal Toxicity in Mammals", *Chemical Toxicity of Metals and Metalloids*, vol. 2, Plenum Press, New York-London 1978.
71. H. C. Dudley, E. J. Wallace, *AMA Arch. Ind. Hyg. Occup. Med.* 6 (1952) 263.
72. G. Rosenfeld, E. J. Wallace, *AMA Arch. Ind. Hyg. Occup. Med.* 8 (1953) 466.
73. G. H. Bailey, B. P. Davidson, C. H. Bunting, *JAMA J. Am. Med. Assoc.* 84 (1925) 1722.
74. G. C. Harold, S. F. Meek, *Ind. Med.* 13 (1944) 326.
75. E. G. Rochow, B. M. Sindler, *J. Am. Chem. Soc.* 72 (1950) 1218.
76. J. E. Cremer, W. N. Aldridge, *Br. J. Ind. Med.* 21 (1964) 214.
77. NIOSH Registry of Toxic Effects of Chemical Substances, Washington, DC, 1976.
78. S. H. Webster, *J. Ind. Hyg. Toxicol.* 28 (1946) 167.
79. R. Kühn, K. Birett: *Merkblätter Gefährliche Arbeitsstoffe*, vol. 5, Blatt Nr. C, 06, Verlag Moderne Industrie, München 1980.
80. Deutsche Forschungsgemeinschaft (ed.): *Maximale Arbeitsplatzkonzentration (MAK)*, Liste A1, A2, B, 1987, VCH Verlagsgesellschaft, Weinheim 1987.

## 35 Gallium

JÖRG FRIEDRICH GREBER (§§ 35.1–35.9); FATHI HABASHI (§ 35.10)

35.1 Introduction	1523	35.9 Toxicology and Industrial Medicine	1528
35.2 Physical Properties	1523	35.10 Compounds	1528
35.3 Chemical Properties	1523	35.10.1 Gallium(III) Compounds	1528
35.4 Occurrence and Raw Materials	1524	35.10.2 Gallium(II) and Gallium(I) Compounds	1529
35.5 Production	1524	35.10.3 Gallium Alkyls and Gallium Hydride	1530
35.6 Storage and Transportation	1527	35.11 References	1530
35.7 Uses	1527		
35.8 Economic Aspects	1527		

### 35.1 Introduction

Existence of gallium was predicted by MENDELEEV, and it was discovered by LECOQ DE BOISBAUDRAN in 1875. The metal was mainly of academic interest until 1970, when it was found that compounds of gallium with group 15 elements have semiconducting properties, and so began the extensive industrial use of the element. Gallium compounds are of particular value in optoelectronics, especially for light-emitting diodes.

### 35.2 Physical Properties

Gallium is a silvery-white metal, *mp* 29.78 °C, *bp* 2403 °C. The naturally occurring element contains two stable isotopes: <sup>69</sup>Ga (60.4%) and <sup>71</sup>Ga (39.6%). The density of the liquid is 6.095 g/cm<sup>3</sup> at 29.8 °C, and the density of the solid is 5.904 g/cm<sup>3</sup> at 24.6 °C. There is a volume expansion of 3.2% on solidification.

Gallium forms orthorhombic crystals with the lattice constants *a* = 0.4523 nm, *b* = 0.45198 nm, and *c* = 0.76602 nm, and the physical properties are consequently strongly anisotropic. The thermal expansion coefficients are 1.65 × 10<sup>-5</sup> K<sup>-1</sup> along the *a* axis, 1.13 × 10<sup>-5</sup> K<sup>-1</sup> along *b*, and 3.1 × 10<sup>-5</sup> K<sup>-1</sup> along *c*. The electrical properties are equally anisotropic, but it is not possible to quote reliable fig-

ures owing to the great influence of purity and temperature on the electrical conductivity.

### 35.3 Chemical Properties

[1–4]

Metallic gallium dissolves only slowly in dilute mineral acids, but rapidly in aqua regia and concentrated aqueous sodium hydroxide. It also dissolves slowly in solutions of hydrogen halides in ether.

In its compounds, the valency of gallium is usually 3. The monovalent state is unstable, although the monovalent gallium compounds Ga<sub>2</sub>O and GaCl can be isolated. An oxidation state of 1+ has not yet been detected in aqueous solution, but some reactions of gallium indicate that it exists.

The oxygen compounds of gallium resemble those of aluminum in that there are high and low temperature forms of Ga<sub>2</sub>O<sub>3</sub> and two hydroxides, Ga(OH)<sub>3</sub> and GaO·OH. Gallium halides have covalent character and therefore have good solubility in many nonpolar solvents in which they exist in dimeric form.

With elements of group 15, gallium forms binary compounds, of which GaP and GaAs are of great industrial importance. They may be prepared by direct combination of the elements at high temperature.

In aqueous solution, gallium forms octahedrally coordinated aquo ions [Ga(H<sub>2</sub>O)<sub>6</sub>]<sup>3+</sup>. There are many salts of oxoacids, such as the



sulfate, nitrate, and perchlorate, and also hydrated halides.

In aqueous solution, the hexaquo complex has an acid reaction owing to hydrolysis. Gallium salts of weak acids cannot exist in the presence of water for the same reason. Of the numerous anionic and cationic complexes, the most industrially important are the halide complexes, the  $[\text{GaX}_4]^-$  ions, whose oxonium salts have good solubility in several organic solvents. This property is utilized in the extraction and purification of the metal. Other gallium complexes of industrial importance are the octahedrally coordinated chelates with p-diketones and 8-hydroxyquinolines, these also being soluble in organic solvents. Alcohols and organic derivatives may be prepared similarly to the analogous aluminum compounds.

Gallium forms a series of alloys with other metals, sometimes even at low temperatures. Some of these, containing up to 3% gallium, are useful in dentistry.

### 35.4 Occurrence and Raw Materials

With its natural abundance of 16 ppm, gallium is one of the rarer elements in the earth's crust. Gallium-containing minerals, the best known of which is a variety of germanite, do not have economic significance. Of the known locations, only the Apex mine in Utah has been commercially mined.

The greatest part of the world production of gallium is as a by-product of the production of aluminum oxide. The gallium concentration in bauxite ranges between 0.003 and 0.008%, depending on the location. The high contents occur in tropical bauxites such as Surinam bauxite, which contains 0.008% Ga, the highest average content known. The world supply of recoverable gallium in bauxite is estimated at  $1.6 \times 10^6$  t based on bauxite reserves and their gallium contents [5].

The amount of gallium available from bauxite is determined by the amount of aluminum oxide that is produced. For the year 1986,

complete utilization of the gallium from aluminum oxide production would have corresponded to a theoretical production of ca. 2000 t of gallium. The gallium contained in zinc ore (sphalerite) has lost economic importance due to the changeover to hydrometallurgical methods of zinc extraction. The reserves of gallium in zinc ores worldwide has been estimated to be 6500 t [5].

The largest reserves of gallium are contained in phosphate ores and in coal of various kinds. When phosphorus is produced electrothermally from phosphate, the gallium is concentrated in the flue dust and may be recovered from it. Likewise, gallium may be obtained from the fly ash of coal, another material in which gallium is concentrated. Neither source is exploited at present because the gallium concentration is only 0.01–0.1%. It is not economic to treat these materials merely to extract the gallium. The total gallium reserves in phosphates and coals have been estimated at several million tonnes. They thus considerably exceed those in bauxite [5].

### 35.5 Production

The most important process for gallium production is the extraction of the metal from the circulating liquors in the Bayer process for aluminum oxide manufacture. These contain 70–150 mg/L of gallium, depending on the bauxite and on the concentration of the caustic liquor. The gallium content of the liquor is also determined by the dissolution process used. Bauxite which is high in boehmite ( $\text{AlO} \cdot \text{OH}$ ) requires high temperatures for the dissolution process, leading to more complete release of the gallium and higher concentrations in the circulating liquors.

The gallium extraction plant is usually located within or very near to the aluminum oxide works. Part of the liquor stream is diverted for gallium extraction and then recycled. In some instances the liquor undergoes a preliminary purification process to remove certain heavy metals.

Three types of process are used to extract the gallium from the circulating liquor: (1) fractional precipitation, (2) electrolytic processes, and (3) extraction with chelating agents.

**Fractional Precipitation.** The basis of this process is that when the gallium-containing sodium aluminate solution is treated with carbon dioxide the first product precipitated is pure aluminum hydroxide. This increases the gallium content of the liquor. Further treatment then causes the gallium to separate along with more aluminum hydroxide. After this, fractional precipitation gives an aluminum hydroxide richer in gallium, and this is followed by one or more further fractional precipitations. The gallium-enriched aluminum hydroxide is dissolved in aqueous sodium hydroxide to give a solution of sodium aluminate and sodium gallate, from which gallium is obtained by electrolysis.

The precipitation process is used only to a small extent because of the expense of removing the by-product sodium carbonate unless thermal decomposition is used in the aluminum oxide works. Also, on account of the many precipitation stages involved, the process is labor intensive and can therefore be used only when energy and labor costs are low. China produces gallium at a rate of 5 t/a by this process.

**Electrolytic Processes.** The electrolytic process depends on the fact that mercury forms an amalgam with gallium from which the gallium may be extracted with a caustic soda solution. The gallium amalgam can be produced either directly (Alusuisse process) or indirectly (VAW/INGAL process).

In the Alusuisse process, the gallium is deposited directly onto the mercury cathode, using the appropriate conditions of temperature, agitation, and current density, and an amalgam is formed. In the VAW process, sodium amalgam is used to reduce the gallium present in the Bayer liquor. This gives an amalgam from which the gallium is removed by treatment with caustic alkali, and the mercury is then used again to produce sodium amalgam, i.e., the mercury circulates in a closed system.

Reduction processes have in recent years become less attractive because they require special conditions to be commercially viable. In particular, the aluminate solutions must contain over 150 g/L sodium and be very low in vanadium, tungsten, molybdenum, and iron so that the electrolytic current efficiency reaches economically acceptable values. However, such highly concentrated liquors are not produced in modern aluminum oxide plants, and therefore the electrolytic process can no longer be used in new installations. The environmental problems associated with mercury further discourage the use of electrolytic processes. These processes are, however, in operation in Hungary, former Czechoslovakia, and Germany. About 15–20 t/a of gallium is produced.

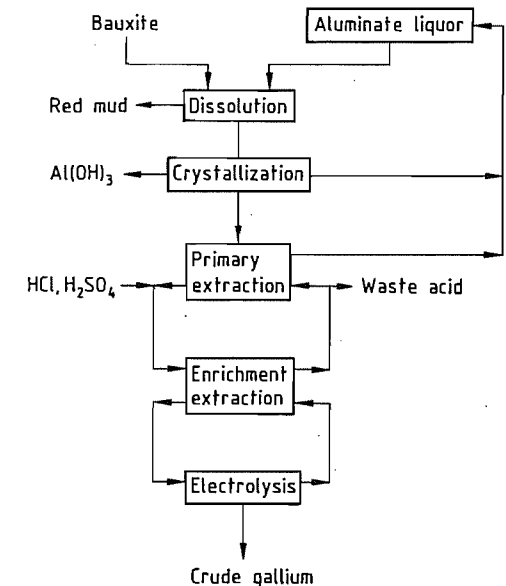

Figure 35.1: Flow diagram showing gallium extraction by the Rhône-Poulenc and Sumitomo processes.

**Extraction with Chelating Agents.** The discovery was made in 1974 that hydroxyquinolines could be used to extract gallium from sodium aluminate liquors (the Rhône-Poulenc process, Figure 35.1) [6], these substances having earlier been developed for the hydrometallurgical extraction of copper. The aluminate liquor is brought into contact with a

solution of Kelex 100 in kerosene. Gallium is thereby extracted from the liquor along with aluminum and sodium. Most of the elements extracted with the gallium may be stripped from the extraction medium by treatment with dilute acid. The gallium is then extracted with concentrated acid; either hydrochloric or sulfuric acid may be used. Gallium concentrations of 0.1–10 g/L may be reached in the acid extract, depending on the method used. The gallium to aluminum concentration ratio in the extract can reach values as high as 1, which corresponds to enrichment factors of up to 1000 in the primary extraction stage.

Further concentration of the gallium is achieved by anion- or cation-exchange treatment of the acid extract from the first stage. The metal can be isolated from this concentrate by direct electrolysis.

Although the process solutions are recirculated to a large extent, considerable quantities of waste acid are generated. This waste acid is contaminated with other extracted metals and residues from the extraction media. An important economic factor in the extraction process is therefore the possibility to dispose of these solutions cheaply or to make some use of them.

In the Sumitomo process (Figure 35.1) the first stage is extraction with the ion-exchange resin Duolite CS-346 (Diamond Shamrock) [7]. This resin contains amidoxime groups, which form chelate bonds to gallium. Unlike Kelex 100, this resin has the drawback that any vanadium extracted from the aluminate liquors blocks the ion exchange sites. Vanadium must therefore be removed from the circulating liquor of the aluminum oxide plant before gallium extraction. The rest of the Sumitomo process corresponds to the Rhône-Poulenc process.

Gallium is produced by extraction processes in France and Japan.

**Purification.** The gallium from extraction processes has a purity of 99–99.9%. For most applications, however, much higher purities are necessary, reaching 99.99999% (8N). Various procedures are used to remove the im-

purities. Volatile metals, such as mercury and zinc, are distilled off under vacuum. Further purification is effected by washing with aqueous acids and alkalis. The purest gallium is obtained by fractional crystallization, zone melting, or single crystal growth. Other methods of purification include the extraction of gallium chloride from acid solution and fractional distillation of liquid gallium compounds.

**Environmental Protection.** No harmful effects of gallium or its compounds have been reported. There are therefore no regulations concerning gallium concentrations in exhaust gases from gallium manufacturing plants. For the materials used in gallium manufacture, such as mercury or 8-hydroxyquinoline, the relevant legal requirements must be observed.

**Quality.** The commercially available materials include a crude grade and various pure grades of gallium. The crude metal contains 99–99.9% gallium. The material for semiconductor manufacture is used in purities from 99.9999% (6N) to 99.99999% (8N).

**Analysis.** Gallium is determined in raw materials and partially enriched intermediate products either by complexometric titration (high concentrations) or atomic absorption (low concentrations).

For the analysis of the purest grades of gallium it is necessary to have methods of determining impurities at parts per million to parts per billion levels. The most important technique is spark source or glow discharge mass spectrometry which enables heavy metals to be determined with sufficient accuracy. Lighter elements can be determined by activation analysis or by special mass spectrometric techniques.

A general assessment of gallium purity may be made from its residual resistance ratio. This is determined from the electrical conductivity of a gallium single crystal at room temperature and at liquid helium temperature. This ratio is very sensitive to the presence of impurities but is nonspecific. Typical values for high purity gallium are better than 55 000.

## 35.6 Storage and Transportation

The low melting point of gallium and the high purity requirements mean that care must be taken to prevent gallium from melting or being contaminated by the packing materials during storage and transportation. The metal is usually sold in lumps of 10 g–2 kg, individually packed and kept cold in plastic containers.

For short distances, gallium may be carried by truck or rail, provided that the temperature is not allowed to exceed 20 °C. For carriage over long distances, the method chosen is usually air transport, in which uninterrupted cooling is to be maintained. Regulations governing packaging for air transport have been laid down by IATA owing to the ability of gallium to form alloys with aluminum at normal temperatures, these alloys having very low mechanical strength. Gallium must be contained inside seven layers of packing material and in warm weather the container must be cooled. In this way, the danger of an accident in which the structural metal of the aircraft is attacked by liquid gallium can be reduced. In addition, there is a limit imposed on the amount of gallium which may be carried in an aircraft.

## 35.7 Uses

The main use of gallium is as a raw material in the manufacture of semiconductors which are formed by the combination of gallium with elements of group 15 (especially P and As). They have certain advantages over other semiconductor materials: (1) faster operation with lower power consumption, (2) better resistance to radiation and, most importantly, (3) they may be used to convert electrical into optical signals.

The largest proportion of the gallium produced worldwide goes to the manufacture of the arsenide or phosphide for the production of light-emitting diodes. The manufacture of integrated circuits using gallium arsenide is still at the development stage. A small proportion of the gallium produced is converted into

the oxide for manufacture of gallium–gadolinium garnets [8]. These are used to produce magnetic bubble memories.

## 35.8 Economic Aspects

In 1986, 50 t gallium was used worldwide (Figure 35.2), mainly in the manufacture of light-emitting diodes and other optoelectronic components.

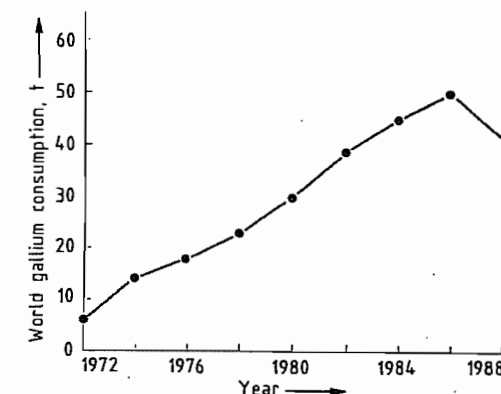

Figure 35.2: World gallium consumption.

About 65% of the market is in Japan, 20% in the United States, and 15% in Europe. The price has fallen continuously since 1970 and in 1986 reached \$450 or 77 000 yen per kg for 6N gallium. The total value of the gallium used worldwide in 1986 was therefore \$22 × 10<sup>6</sup> (3.85 × 10<sup>9</sup> yen). Gallium is extracted in Western Europe, Japan, and several countries of the Eastern Bloc. Production levels in the former Soviet Union, former East Germany, Hungary, and former Czechoslovakia are not known exactly as only a small part of the gallium produced there is exported.

The following companies produce gallium: INGAL (Germany), Rhône-Poulenc (France), Sumitomo (Japan), and Dowa Mining (Japan). Musto Mining (USA), Eagle Picher (USA), Alcan (Canada), and Cominco (Canada) have ceased production.

In addition to these producers of primary gallium, a number of companies recover pure gallium from gallium scrap. World gallium production increased from 17 800 kg in 1978

to 46 200 kg in 1984, but decreased to 40 000 kg in 1988 (Table 35.1).

**Table 35.1:** Gallium production in kilograms of gallium for 1978, 1984, and 1988.

Region and country	Year		
	1978	1984	1988
Europe			
Czechoslovakia		2 000	2 000
France	2 000	10 000	8 000
Germany	4 000	8 000	8 000
Hungary	1 000	3 000	2 000
Others	1 000	1 200	2 000
Asia			
Japan	200	13 000	12 000
China	600	5 000	5 000
United States	8 000	3 000	
Others	1 000	1 000	1 000
<b>Total</b>	<b>17 800</b>	<b>46 200</b>	<b>40 000</b>

## 35.9 Toxicology and Industrial Medicine

Gallium is only slightly toxic. No industrial injury caused by the metal or its compounds during gallium production and processing has been reported. An investigation in 1984 and 1985 by the Chemical Trade Association did not reveal any evidence of damage to health caused by gallium.

## 35.10 Compounds [9, 10]

Gallium is ordinarily trivalent in its compounds. The salts are colorless, and are more strongly hydrolyzed in solution than the salts of aluminum, which they closely resemble in properties. Like aluminum it is precipitated as the white oxide hydrate from solutions of its salts by any substance which disturbs the hydrolysis equilibrium by reducing the hydrogen ion concentration. Tartaric acid hinders the precipitation, by forming complexes with gallium, as it does with aluminum.

For bivalent gallium, the halides  $\text{GaCl}_2$  and  $\text{GaBr}_2$ , and the chalcogenides  $\text{GaS}$ ,  $\text{GaSe}$ , and  $\text{GaTe}$  are known, but not gallium(II) oxide. Gallium(II) compounds readily undergo oxidation, or disproportionation to give gallium(III) compounds and gallium metal. Gallium(I) compounds are still less stable, and

in only a few cases has their existence been proved. The sulfide,  $\text{Ga}_2\text{S}$ , and the selenide,  $\text{Ga}_2\text{Se}$ , exist, but may be metastable at ordinary temperature. The existence of a volatile hydride of gallium is notable.

**Table 35.2:** Gallium halides.

	Density, g/cm <sup>3</sup>	mp, °C	bp, °C	Heat of formation, kcal/mol
$\text{GaCl}_3$	2.47	77.9	201.3	
$\text{GaBr}_3$	3.69	121.5	279	92.4
$\text{GaI}_3$	4.15	212	346	51.0
$\text{GaF}_3$	4.47	800 (subl.)		

### 35.10.1 Gallium(III) Compounds

Table 35.2 summarizes gallium halides.

**Gallium(III) chloride**,  $\text{GaCl}_3$ , forms long white crystals. It may be obtained by heating gallium in a stream of chlorine or of hydrogen chloride. Vapor density determinations have shown that in the neighborhood of the boiling point, the vapor consists of double molecules,  $\text{Ga}_2\text{Cl}_6$  similar to  $\text{Al}_2\text{Cl}_6$ . At 600 °C the vapor density corresponds to that required by the formula  $\text{GaCl}_3$ . Fused gallium chloride is practically a non-conductor of electricity. The heat of formation of  $\text{GaCl}_3$  is 125 kcal per mol. Gallium(III) chloride combines exothermically with water. It fumes in moist air, since it forms hydrogen chloride by hydrolysis. Its aqueous solution is acidic and readily deposits the hydroxide. Gallium(III) chloride can be extracted by means of ether from its 6-N HCl solutions and this property can be used to effect a separation of gallium from other elements.

**Gallium Bromide and Gallium Iodide.** Gallium bromide,  $\text{GaBr}_3$ , and gallium iodide,  $\text{GaI}_3$ , resemble the chloride in properties. Electron diffraction measurements show that both the chloride and bromide exist as dimeric molecules in the vapor state.

**Gallium fluoride**,  $\text{GaF}_3$ , sublimes at 950 °C and is only slightly soluble in water or dilute hydrochloric acid. The hydrate,  $\text{GaF}_3 \cdot 3\text{H}_2\text{O}$ , obtained by dissolution of gallium(III) oxide hydrate in aqueous hydrofluoric acid, is soluble in dilute hydrochloric acid, and the gallium

must therefore be complexed. Addition of  $\text{NH}_4\text{F}$  to the solution yields octahedral crystals of  $(\text{NH}_4)_3[\text{GaF}_6]$ .

**Gallium(III) oxide**,  $\text{Ga}_2\text{O}_3$ , is best obtained by heating the nitrate or sulfate. It is a white powder, which like aluminum oxide, loses its solubility in acids and caustic alkalis when it is strongly ignited. It is reduced to the metal when it is heated in hydrogen;  $\text{Ga}_2\text{O}$  may be formed as an intermediate stage. Gallium(III) oxide is polymorphic, like alumina. The modification stable below 600 °C ( $\alpha$ - $\text{Ga}_2\text{O}_3$ ) has the corundum structure; the form stable at high temperatures ( $\beta$ - $\text{Ga}_2\text{O}_3$ ) is either rhombic or monoclinic. Ignition of gallium nitrate at low temperatures yields a modification ( $\delta$ - $\text{Ga}_2\text{O}_3$ ).  $\text{Ga}_2\text{O}_3$  also forms double oxides of spinel structure with  $\text{MgO}$  and  $\text{ZnO}$ .

**Gallium Oxide Hydrate and Gallium Hydroxide.** Substances which lower the hydrogen ion concentration throw down a white gelatinous precipitate from  $\text{Ga(III)}$  salt solutions. This precipitate is amorphous to x-rays and has a variable water content (gallium oxide hydrate,  $\text{Ga}_2\text{O}_3 \cdot x\text{H}_2\text{O}$ ). It dissolves both in acids and in strong bases, and differs from aluminum oxide hydrate in being soluble in ammonia solutions. As the precipitate ages, its solubility in caustic alkalis diminishes.

A microcrystalline gallium(III) hydroxide of definite composition can be obtained by slow precipitation from both alkaline and acidic solutions. This is gallium oxide hydroxide,  $\text{GaO(OH)}$ , which has the  $\alpha$ - $\text{AlO(OH)}$  or diaspore structure. The same compound is formed by hydration of  $\alpha$ - and  $\delta$ - $\text{Ga}_2\text{O}_3$  with steam under certain conditions. Alkaline solutions of gallium hydroxide contain salts known as gallates.

**Gallium(III) sulfide**,  $\text{Ga}_2\text{S}_3$ , is isolated by direct union of the elements. Reaction proceeds to completion only at high temperatures (1200 °C). Gallium(III) sulfide is yellow, with a *mp* of about 1225 °C and *d* 3.48. It is decomposed by water, with evolution of  $\text{H}_2\text{S}$ , and reduced by hydrogen at 800 °C to gallium(II) sulfide,  $\text{GaS}$ . This is a yellow solid, with a *mp*

of about 965 °C and *d* 3.75. It is stable towards water, but decomposes when it is heated in vacuum:



The gallium(I) sulfide so formed is a grey black sublimate (*d* 4.22), which decomposes into  $\text{Ga}_2\text{S}_3 + \text{Ga}$  when it is heated again.

**Gallium sulfate**,  $\text{Ga}_2(\text{SO}_4)_3$ , crystallizes from aqueous solutions as an 18-hydrate similar to  $\text{Al}_2(\text{SO}_4)_3 \cdot 18\text{H}_2\text{O}$ , as white clusters. It can be dehydrated by heating, and decomposes above 520 °C with loss of  $\text{SO}_3$ . With ammonium sulfate, it forms the double salt  $(\text{NH}_4)\text{Ga}(\text{SO}_4)_2 \cdot 12\text{H}_2\text{O}$ , ammonium gallium alum. Among the basic double sulfates, the compound  $(\text{NH}_4)(\text{GaO})_3(\text{SO}_4)_2 \cdot 4\text{H}_2\text{O}$  is isotopic with the mineral alunite,  $\text{K}(\text{AlO})_3(\text{SO}_4)_2 \cdot 3\text{H}_2\text{O}$ .

**Gallium nitrate** crystallizes from nitric acid solutions as the octahydrate,  $\text{Ga}(\text{NO}_3)_3 \cdot 8\text{H}_2\text{O}$ , in colorless, highly refractive deliquescent prisms (*mp* ca. 65 °C). The hydrate is converted to the anhydrous salt,  $\text{Ga}(\text{NO}_3)_3$ , when it is warmed to about 40 °C in dry air.

**Gallium nitride**,  $\text{GaN}$ , is obtained as a dark grey powder (*d* 6.10) by heating the metal in ammonia at 900–1000 °C. It is unattacked by most acids, but is slowly converted to  $\text{Ga}_2\text{O}_3$  when it is heated in air.

### 35.10.2 Gallium(II) and Gallium(I) Compounds

**Gallium(II) chloride**,  $\text{GaCl}_2$ , is formed by the incomplete combustion of gallium in chlorine, or by heating gallium(III) chloride with metallic gallium. It forms colorless transparent crystals (*mp* 170.5 °C, *bp* ca. 535 °C). At 1000 °C, the vapor density of gallium(II) chloride corresponds to the molecular formula  $\text{GaCl}_2$ . At lower temperatures, polymeric molecules are also present and at higher temperatures some dissociation occurs. Gallium(II) chloride reacts vigorously with water with hydrogen evolution. Gallium(II) bromide resembles the chloride.

### 35.10.3 Gallium Alkyls and Gallium Hydride

**Gallium triethyl**,  $\text{Ga}(\text{C}_2\text{H}_5)_3$ , is obtained by the action of metallic gallium on mercury diethyl:

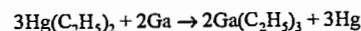

It is a colorless, unpleasant smelling liquid ( $d$  1.058,  $mp$   $-82.3^\circ\text{C}$ ,  $bp$   $142.8^\circ\text{C}$ ). It inflames in air, and is decomposed by water with explosive violence. Gallium trimethyl,  $\text{Ga}(\text{CH}_3)_3$ , ( $mp$   $-15.8^\circ\text{C}$ ) can be obtained in the same way as the triethyl.

**Gallium hydride**. Gallium trimethyl reacts with hydrogen, under the influence of the electrical glow discharge, to form tetramethyl digallane,  $\text{Ga}_2\text{H}_2(\text{CH}_3)_4$ , a colorless, viscous liquid. When this is heated above  $130^\circ\text{C}$ , it decomposes into  $\text{Ga}(\text{CH}_3)_3$ , Ga, and  $\text{H}_2$ . Acting on the hypothesis that this reaction involved a disproportionation into  $\text{Ga}(\text{CH}_3)_3$  and  $\text{Ga}_2\text{H}_6$ . The addition of trimethylamine, with which gallium trimethyl forms the stable compound  $(\text{CH}_3)_3\text{Ga}\cdot\text{N}(\text{CH}_3)_3$ , brought about reaction at ordinary temperature. Gallium

hydride could then be isolated without decomposition. It is a colorless, mobile liquid ( $mp$   $-21.4^\circ\text{C}$ ,  $bp$   $139^\circ\text{C}$ ), which decomposes fairly rapidly above  $130^\circ\text{C}$  into Ga and  $\text{H}_2$ . The molecular weight corresponds to the formula  $\text{Ga}_2\text{H}_6$  (digallane), corresponding in complexity and structure (hydrogen bridged structure) to diborane.

### 35.11 References

1. F. A. Cotton, G. Wilkinson: *Advanced Inorganic Chemistry*, 4th ed., Wiley, New York 1980, pp. 326–351.
2. *Gmelin*, 8, System no. 36.
3. *Gmelin*, Organogallium Compounds, Part 1 (1987).
4. I. A. Sheka, I. S. Clans, T. T. Mityureva: *The Chemistry of Gallium*, Elsevier, Amsterdam 1966.
5. F. E. Katrak, J. C. Agarwal, *J. Met.* 33 (1981) no. 9, 33.
6. Rhône-Poulenc, FR 2307047, 1974 (J. Helgorsky, A. Leveque).
7. Sumitomo Chem. Comp., EP 0076404, 1983.
8. Vereinigte Aluminiumwerke AG, DE 2517292, 1975 (H. Pfundt, M. Fuchs, P. Voß).
9. *Gmelin Handbook of Inorganic Chemistry*, System No. 36: Gallium, Springer Verlag, Berlin 1936.
10. H. Remy, *Lehrbuch der anorganischen Chemie*, volume 1, Akademische Verlagsgesellschaft, Leipzig 1965, pp. 445–449.

## 36 Indium

NOËL FELIX

36.1 Introduction	1531	36.6 Quality Specifications	1537
36.2 History	1531	36.7 Analysis	1537
36.3 Properties	1531	36.8 Compounds	1537
36.4 Resources and Raw Materials	1532	36.9 Uses	1538
36.5 Production	1532	36.10 Economic Aspects	1539
36.5.1 Production from Zinc Circuits	1532	36.11 Toxicology and Occupational Health	1540
36.5.2 Production from Lead Circuits	1534	36.12 References	1540
36.5.3 Production from Tin Circuits	1536		
36.5.4 Recent Production Developments	1536		
36.5.5 Refining	1536		

### 36.1 Introduction

Indium, atomic number 49, is a metallic element of group 13 of the periodic table. Indium has two natural isotopes:  $^{115}\text{In}$  (95.72%) and  $^{113}\text{In}$  (4.28%). The abundance of indium in the earth crust is comparable to that of silver, i.e., 0.1 ppm [1].

### 36.2 History

Indium was discovered in 1863 by F. REICH and T. H. RICHTER during spectrometric analysis of sphalerite ores at the Freiberg School of Mines in Germany [2]. Indium is named after the indigo blue spectral lines that led to its identification.

### 36.3 Properties [3–8]

Indium is a crystalline, silvery white metal, which is very soft (softer than lead), ductile, and malleable. Indium retains its highly plastic properties at cryogenic temperatures. Indium can be deformed almost indefinitely under compression, is easily cold-welded, and, like tin, emits a high-pitched “cry” on bending.

Indium generally increases the strength, corrosion resistance, and hardness of an alloy system to which it is added. Even small con-

centrations of indium can have a considerable influence.

Molten indium wets clean glass. Indium has a low melting point (429.75 K) but a high boiling point (2353.15 K). Indium becomes superconducting at 3.37 K.

Some physical properties of indium are as follows [3, 5, 7]:

Electronic configuration	[Kr] $4d^{10}5s^25p^1$
Thermal neutron cross section at 2200 m/s absorption	$(194 \pm 2) \times 10^{-28}$ m <sup>2</sup> /atom
scattering	$(2.2 \pm 0.5) \times 10^{-28}$ m <sup>2</sup> /atom
Crystal structure	tetragonal A6 $a_0 = 0.458$ nm $c_0 = 0.494$ nm
Number of atoms per unit cell	4
Atomic radius (coordination number 12)	0.162 nm
Ionic radius ( $\text{In}^{3+}$ , coordination number 6)	0.081 nm
Atomic volume	$15.73 \times 10^{-6}$ m <sup>3</sup> /mol
Density at 20 °C	7.310 g/cm <sup>3</sup>
$mp$	429.75 K
$bp$	2353.15 K
Enthalpy of fusion	3.26 kJ/mol
Enthalpy of vaporization	231.2 kJ/mol
Specific heat at 25 °C	26.70 kJmol <sup>-1</sup> K <sup>-1</sup>
Entropy at 25 °C	57.7 kJmol <sup>-1</sup> K <sup>-1</sup>
Entropy of fusion	7.58 kJmol <sup>-1</sup> K <sup>-1</sup>
Entropy of vaporization	98.56 kJmol <sup>-1</sup> K <sup>-1</sup>
Coefficient of linear expansion (0–100 °C)	$3 \times 10^{-5}$ K <sup>-1</sup>
Vapor pressure $p$ , kPa, at temp. $T$ , K, between $mp$ and $bp$	$\log p = 9.835 - 12.860/T - 0.7 \log T$
Thermal conductivity (0–100 °C)	71.1 Wm <sup>-1</sup> K <sup>-1</sup>
Surface tension at temperature $T$ , N/m	$0.602 - 10^{-4}T$
Electrical resistivity at 3.38 K	superconducting

at 273.15 K	$8.4 \times 10^{-8} \Omega m$
temperature coeff. (0–100 °C)	$4.9 \times 10^{-3} K^{-1}$
Standard electrode potentials	
$In^{3+} + 3e^- \rightleftharpoons In$	-0.338 V
$In^{3+} + 2e^- \rightleftharpoons In^+$	-0.40 V
$In^{2+} + e^- \rightleftharpoons In^+$	-0.40 V
$In^{3+} + e^- \rightleftharpoons In^{2+}$	-0.49 V
Brinell hardness	0.9
Tensile strength	2.645 MPa
Modulus of elasticity	10.8 GPa

Metallic indium is not oxidized by air or oxygen at room temperature. It reacts directly with arsenic, antimony, the halogens, oxygen, phosphorus, sulfur, selenium, and tellurium when heated. Indium dissolves only slowly in cold dilute mineral acids, but more readily in hot dilute or concentrated acids. Alkalis do not attack the massive metal. Indium forms alloys with most other metals. Extensive solid solutions are formed with lead, thallium, and mercury.

**Table 36.1:** Indium contents of some minerals [9]. (Reproduced from Roskill: *The Economics of Indium*, 4th ed., 1987, by permission of the publisher, Roskill Information Services Ltd.)

Mineral	Composition	Indium content, ppm
Sphalerite	ZnS	0.5–10 000
Galena	PbS	0.5–100
Chalcopyrite	CuFeS <sub>2</sub>	0–1500
Enargite	Cu <sub>3</sub> AsS <sub>4</sub>	0–100
Bornite	Cu <sub>5</sub> FeS <sub>4</sub>	1–1000
Tetrahedrite	(Cu, Fe) <sub>12</sub> Sb <sub>4</sub> S <sub>13</sub>	0.1–160
Covellite	CuS	0–500
Chalcocite	Cu <sub>2</sub> S	0–100
Pyrite	FeS <sub>2</sub>	0–50
Stannite	Cu <sub>2</sub> FeSnS <sub>4</sub>	0–1500
Cassiterite	SnO <sub>2</sub>	0.5–13 500
Wolframite	(Fe, Mn)WO <sub>4</sub>	0–16
Arsenopyrite	FeAsS	0.3–20

### 36.4 Resources and Raw Materials [9]

Indium does not occur in the native state. It is widely spread in nature, generally in very low concentrations. The content of indium in the earth crust is estimated to be 0.1 ppm. Indium is found as a trace element in many minerals (Table 36.1).

Sphalerite is the most important indium-containing mineral followed by lead and copper sulfides. The amount of indium in sphalerite may vary widely even within a deposit. The

indium concentration is typically 10–20 ppm, but may be as high as 1% (10 000 ppm). A sphalerite deposit with a very high indium content (0.2–0.3%) is the Huari Huari zinc deposit in Bolivia. Tin deposits with high indium contents (up to 0.21%) are found in Cornwall (United Kingdom) and New Brunswick (Canada).

## 36.5 Production

During smelting processes for the recovery of base metals, indium concentrates in by-products such as residues, flue dusts, slags, and metallic intermediates. The processes for the recovery and production of indium are often complex and sophisticated; they are characterized by a low direct extraction efficiency. Therefore, the recycling of the indium contained in intermediate products is important.

### 36.5.1 Production from Zinc Circuits

A process for the recovery of indium from secondary zinc oxide is described in [10, 11]. The process is illustrated in Figure 36.1. In the first step, most of the zinc is removed by leaching with dilute sulfuric acid. The residue is leached with dilute hydrochloric acid to dissolve the indium. Tin is removed from the indium solution by neutralization to pH 1. Further neutralization then precipitates indium. The indium residue is leached with sodium hydroxide to give crude indium hydroxide as an intermediate product. Dissolution of this indium hydroxide in dilute hydrochloric acid gives an indium solution which is purified by cementation of copper and arsenic with iron, followed by cementation of tin and lead with indium. Indium is recovered from the purified solution by cementation with aluminum.

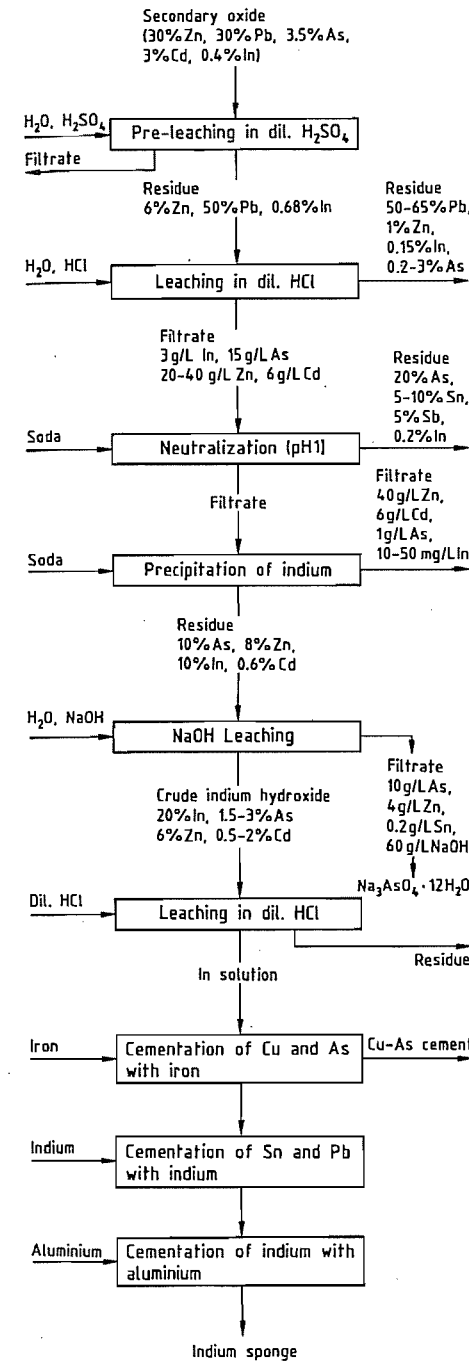

**Figure 36.1:** Recovery of indium from secondary zinc oxide [10, 11].

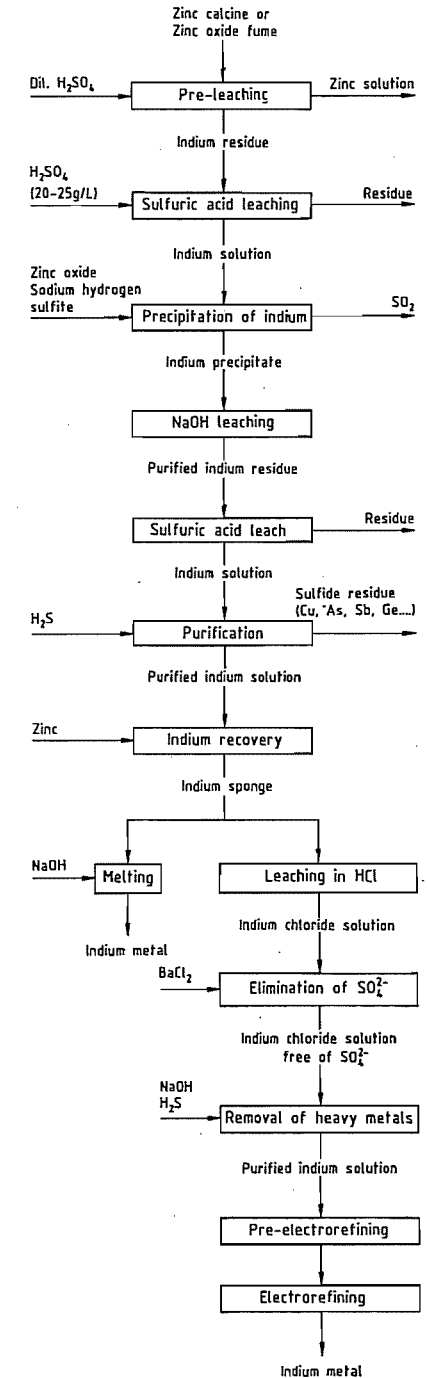

**Figure 36.2:** Indium recovery by Anaconda Copper Mining Company [12].

In the process developed by the Anaconda Copper Mining Company (Figure 36.2), indium is recovered from zinc calcine (roasted zinc blende) or zinc oxide fume [12]. Zinc calcine or zinc oxide fume is first leached in sulfuric acid at moderate pH, dissolving the bulk of the zinc and leaving indium in the residue.

In the second step, indium is dissolved from the residue by leaching with sulfuric acid (20–25 g/L  $H_2SO_4$ ). Indium is precipitated from the resulting solution by adding zinc oxide and sodium hydrogen sulfite. The indium precipitate is purified by leaching with concentrated sodium hydroxide, washing with water and with dilute sulfuric acid to remove zinc. The purified residue is dissolved in sulfuric acid, heavy metals are precipitated with hydrogen sulfide, and indium is recovered as a sponge by adding zinc. The indium sponge may be melted with sodium hydroxide and cast into bars. Alternatively, the sponge may be purified by dissolving it in hydrochloric acid and adding barium chloride to remove sulfate, and hydrogen sulfide to remove heavy metals. After filtration, indium is recovered from the solution by electrolysis.

The extraction of indium from sphalerite of the Rammelsberg and Bad Grund deposits in Germany is described in [13]. On refining the retort zinc by distillation, indium remains with the lead. After oxidation of the lead residue, indium is recovered from the litharge, which contains 1–4% indium. The litharge is leached with sulfuric acid, which dissolves 88–97% of the indium. Indium is recovered by addition of zinc slabs to give a crude indium sponge containing ca. 95% indium. The crude indium is redissolved in sulfuric acid. The resulting solution is purified first by cementation with indium strips to remove tin and then with slabs of a zinc alloy, containing 1% indium and 0.3% cadmium, to remove thallium and cadmium. Indium with a purity of greater than 99.99% is recovered from the purified solution by precipitation with aluminum strips followed by melting under sodium hydroxide and sodium cyanide.

Chlorination of the lead retort residue under a molten salt cover for the extraction of in-

dium has been patented by Asarco [14]. The chloride slag is dissolved in water and indium is recovered by cementation on zinc or aluminum.

At the zinc refinery of Mitsubishi in Akita [15], indium is recovered from the leach residue (400 ppm In) of the zinc concentrate (120 ppm In). The residue is treated by a sulfation roasting process. Leaching of the sulfated product in sulfuric acid dissolves about 60% of the indium to give a leach solution containing 50–70 mg/L of indium. This solution is concentrated to an indium content of 2 g/L by double neutralization with calcium carbonate. The enriched solution is then subjected to solvent extraction followed by back extraction with hydrochloric acid. The aqueous solution is concentrated to 20–30 g/L indium. Indium is recovered by immersing aluminum plates in the solution. Indium sponge adhering to the aluminum plates is removed for melting and casting into anodes. Indium metal of 99.99% purity is then obtained by electrorefining.

### 36.5.2 Production from Lead Circuits

At Cominco's integrated lead–zinc smelter at Trail in Canada, tin and indium accumulate in the fumes of the continuous drossing furnace [16]. The flow sheet for the process is illustrated in Figure 36.3. A mixture of fumes, coke, and antimony-containing slag is melted in a direct-fired rotary furnace. Arsenic is removed by adding scrap iron to form iron speiss. The residual tin–indium–antimony–lead alloy is cast into anodes and electrolyzed in a fluorosilicate solution, giving a solder cathode (Sn–Pb alloy) and indium–antimony anode slimes. The slimes are roasted with sulfuric acid. Indium is dissolved from the sulfated product by leaching with water. Copper is removed from the indium solution by cementation on indium sheets. Indium is then recovered from the solution as a sponge by addition of aluminum or zinc. The indium sponge is melted and electrorefined to give indium of 99.99% purity.

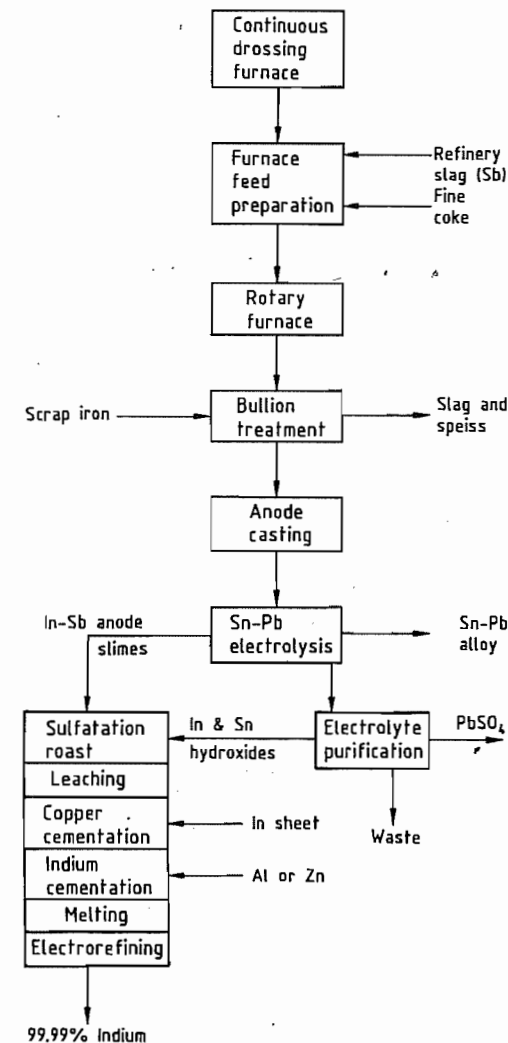

Figure 36.3: Indium recovery by Cominco [16]. (Previously published in the Proceedings of the Symposium on Quality Control in Non-Ferrous Pyrometallurgical Processes from the 24th Annual Conference of Metallurgists, August 1985. Reprinted with permission of the Canadian Institute of Mining and Metallurgy.)

Indium is recovered from lead bullion by Centromin of Peru at the La Oroya smelter, and by Metallurgie Hoboken-Overpelt (MHO) at the Hoboken smelter. At MHO, indium concentrates in a complex residue during refining of lead by the Harris process [17]. At the La

Oroya refinery, lead bullion is first drossed to remove copper, then tin and indium are removed at a higher temperature [18, 19]. The tin–indium dross is reduced to metal using coke, a mixture of lead and zinc chlorides is added, and indium is recovered as indium chloride in the slag.

The chloride slag of indium, lead, zinc, and tin is leached by wet grinding. The solution is purified by cementation of lead and tin on indium sheet. Indium is recovered as a sponge by adding zinc.

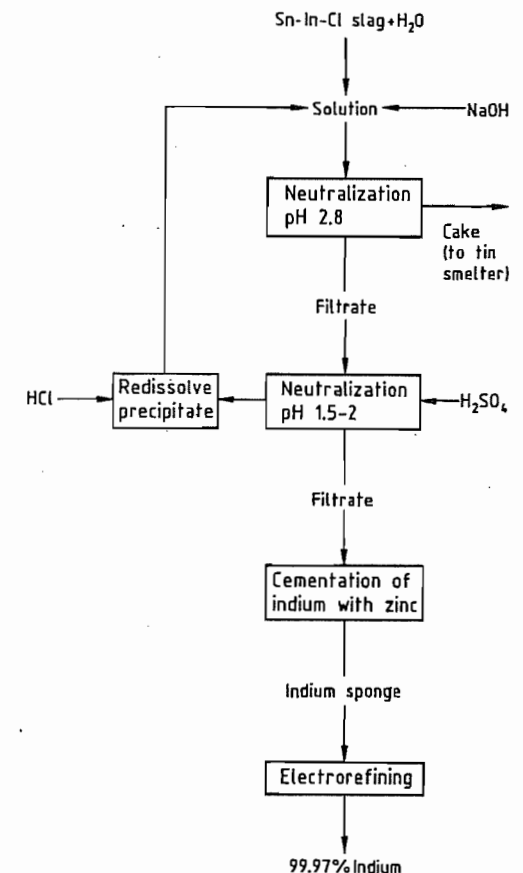

Figure 36.4: Indium recovery by Copper Pass [21]. (Reproduced by permission of the Institution of Mining and Metallurgy, from P. Halsall: Indium—Extraction from Lead, Zinc and Tin circuits (Figure 9). *Trans. Instn. Min. Metall. (Sect. C: Mineral Process. Extr. Metall.)* 97, 1977, C98.)

### 36.5.3 Production from Tin Circuits

At Capper Pass, chlorination of electrorefined tin gives a tin chloride slag which contains 2.7% indium [20]. This slag is treated as shown in Figure 36.4 [21]. Most of the tin is precipitated in the first neutralization stage. The precipitate from the second neutralization stage, which contains some indium, is recycled for indium recovery. Indium is recovered from the filtrate as a sponge by cementation with zinc. The indium sponge of 95% purity is electrorefined to give a 99.5% indium cathode, which is recast as the anode for the second electrorefining stage, in which indium of 99.97% purity is produced.

### 36.5.4 Recent Production Developments

Solvent extraction systems have been investigated to extract indium from various solutions.

The use of a mixture of hydroxyquinolines (Kelex 100 and LIX 26) to extract indium from acidic or alkaline aqueous solutions has been reported [22].

Di-(2-ethylhexyl) phosphoric acid (D2EHPA) in kerosene, and tributyl phosphate (TBP) in kerosene are used to extract indium from the solution obtained by leaching lead-containing residues with sulfuric acid [23]. The concentration of arsenic, cadmium, zinc, copper, antimony, and iron in the extract is greatly reduced. For good separation, iron should be present in the ferrous state.

Solutions of D2EHPA and TBP in kerosene are also reported to extract indium from sulfuric acid solutions that contain tin. The addition of soluble fluorides to the acid solution prior to solvent extraction inhibits the extraction of tin [24].

A process for the separation of indium from gallium and germanium in sulfuric acid solution using solvent extraction is described in [25].

Supported liquid membranes are used to extract indium from a copper-dross leach solu-

tion [26, 27]. The feed solution contains indium (0.5 g/L), copper (60 g/L), and sulfuric acid (30 g/L). The extractant is a 40% solution of D2EHPA in Escaid 100 (a mixture of 80% aliphatic and 20% aromatic long-chain hydrocarbons). A microporous polypropylenic support is used.

The recovery of indium and gallium from spent semiconductor material has also been reported [28].

Table 36.2: Standard potentials, in volts.

$\text{Cd}^{2+}/\text{Cd}$	-0.402
$\text{In}^{3+}/\text{In}$	-0.338
$\text{Tl}^{+}/\text{Tl}$	-0.336
$\text{Sn}^{2+}/\text{Sn}$	-0.136
$\text{Pb}^{2+}/\text{Pb}$	-0.126

### 36.5.5 Refining

Sponge indium with a purity up to 99.5% requires upgrading for most uses. For the semiconductor industry, a purity of at least 99.9999% is required. Electrorefining is a commonly used technique.

In electrorefining, cotton-bagged indium anodes and pure indium cathodes are used. Metallic impurities collect as anode slime in the cotton bag, which thus prevents their entering the bulk electrolyte and contaminating the indium deposit. The electrolyte is generally a chloride solution, but the use of solutions of sulfate [29], cyanide [30], fluoroborate [31], and sulfamate [32] has also been reported.

A typical composition of the electrolyte is 20–75 g/L In, 80–100 g/L NaCl, 1 g/L glue, pH 2.2–2.5. The cathode current density is 1–2 A/dm<sup>2</sup>. Apart from the dendritic nature of the indium deposit, the difficulty with electrorefining lies in the fact that impurities which generally accompany indium have standard potentials close to that of indium (Table 36.2).

For purities up to 99.999%, multistage electrorefining is required [33], or electrorefining must be supplemented by vacuum distillation or zone refining or both of them.

The difference between the melting point and boiling point of indium is greater than for most other elements. This property allows the

elimination of impurities such as cadmium, sulfur, selenium, tellurium, zinc, lead, and thallium by vacuum distillation [34].

Elimination of cadmium, copper, zinc, gold, silver, and nickel by zone refining is described in [35]. Intensive cooling is necessary because of the low melting point of indium.

A method for refining indium to semiconductor grade, in which a chelating agent is used to absorb indium selectively from solution, has been reported [36].

## 36.6 Quality Specifications

Qualities ranging from 99.97% to 99.99999% indium are commercially available. Impurities may be metallic (Ag, Cu, Pb, Sb, Sn, Cd, Tl, Zn, Fe, Al, Ga) and nonmetallic (S, Cl, O, Se, N). Their concentrations depend on the origin of the indium-containing feed material and on the production and refining process.

Commercial grades are 99.97% (3N7), 99.99% (4N), 99.999% (5N), 99.9999% (6N), and 99.99999% (7N).

## 36.7 Analysis

Spectroscopic analysis enables the detection of indium down to 10 ppm due to its characteristic lines in the indigo blue region at wavelengths of 4511.36, 4101.76, 3256.09, and 3039.39 nm. The quantitative analysis of indium in ores, compounds, and alloys is described in [37]. Spark source mass spectrometry and graphite furnace atomic absorption spectrometry are used in the analysis of high purity indium ( $\geq 99.9999\%$ ). About 40 elements can be determined with detection limits of 10–30 ppb by spark source mass spectrometry [38].

## 36.8 Compounds

The most common valence of indium is three. Monovalent and bivalent compounds of indium with oxygen, sulfur, and halogens are also known. The trivalent indium compounds

are the most stable. The lower valence compounds tend to disproportionate to give the corresponding trivalent compounds and indium metal.

The properties of some indium compounds are given in Table 36.3 [7, 39].

*Indium(III) oxide*,  $\text{In}_2\text{O}_3$ , is formed by thermal decomposition of indium hydroxide, carbonate, nitrate, or sulfate in air, or by burning indium in air. It is a pale yellow, amorphous solid when formed at low temperature, but forms red-brown crystals when it is prepared at high temperature. The amorphous form is soluble in acids, but not in alkalis. Indium trioxide is reduced to indium by hydrogen, ammonia, sodium, aluminum, and carbon. *Indium(II) oxide*,  $\text{InO}$ , and *indium(I) oxide*,  $\text{In}_2\text{O}$ , are formed by reduction of indium(III) oxide under carefully controlled conditions.

*Indium hydroxide*,  $\text{In}(\text{OH})_3$ , is precipitated from solutions of indium salts by adjusting the pH in the range 4–10.

*Indium trichloride*,  $\text{InCl}_3$ , is obtained by burning indium in excess chlorine. It is a white, crystalline substance which is easily sublimed, and is very soluble in water. *Indium dichloride*,  $\text{InCl}_2$ , is obtained by the reaction of indium with hydrogen chloride at 200 °C. Indium monochloride,  $\text{InCl}$ , is formed by passing indium dichloride vapor over heated indium. The lower chlorides,  $\text{InCl}$  and  $\text{InCl}_2$ , disproportionate in water to give indium trichloride and indium metal.

*Indium orthoborate*,  $\text{InBO}_3$ , is prepared by melting a mixture of boric oxide and indium hydroxide.

Table 36.3: Properties of some indium compounds [7, 39].

Compound	Density, g/cm <sup>3</sup>	mp, K	bp, K	Enthalpy of formation, kJ/mol
$\text{In}_2\text{O}_3$	7.180	2183		-925
$\text{InCl}$	4.190	498	881	-186
$\text{InCl}_2$	3.620	509	796	-362.4
$\text{InCl}_3$	3.450	856	771 <sup>a</sup>	-535.0
$\text{InAs}$		1215		-57.7
$\text{InSb}$		798		-31.1
$\text{InP}$		1328		-75.2

<sup>a</sup>Sublimes.

**Table 36.4:** Estimated western-world consumption of indium in 1985 [9].

Use	Consumption, t
Low-melting alloys	12
Bearings	9
Dental alloys	7
Nuclear reactor control rods	3.3
Low-pressure sodium lamps	4-5
Electrical contacts	8
Alkaline dry batteries	6.8 <sup>a</sup>
Phosphors	6 <sup>b</sup>
Semiconductors	
Lasers, photodetectors, integrated circuits (Ga-As In-P, In-P)	5
CCDs in infrared video cameras (image orthicons, In-Sb)	3.5
Liquid crystal displays	7

<sup>a</sup> 1987 data [40].<sup>b</sup> 1986 data for Japan [41].

Indium forms alkyl and aryl compounds such as *trimethyl indium*,  $\text{In}(\text{CH}_3)_3$ ; *triethyl indium*,  $\text{In}(\text{C}_2\text{H}_5)_3$ , and *triphenyl indium*,  $\text{In}(\text{C}_6\text{H}_5)_3$ . They are made by treating indium with the corresponding mercury alkyls or mercury aryls, or by reaction of indium trichloride with a Grignard reagent.

The semiconducting compounds *indium antimonide*,  $\text{InSb}$ , *indium arsenide*,  $\text{InAs}$ , and *indium phosphide*,  $\text{InP}$ , are prepared by direct combination of the high-purity elements at high temperature. Indium phosphide is also obtained by thermal decomposition of a mixture of a trialkyl indium compound and phosphine ( $\text{PH}_3$ ).

### 36.9 Uses

Table 36.4 summarizes the western-world consumption of indium by end use [9, 40, 41].

Low-melting alloys represent a major use of indium. Indium is added to *solder alloys*, mostly composed of tin and lead, to increase thermal fatigue resistance, and to improve malleability at low temperature and corrosion resistance. Indium solders are used in *electronics* for fixing semiconductor chips to a base, for assembling semiconductor devices and hybrid integrated circuits, and to seal glass to metal in vacuum tubes. These solders are mainly used in the form of a paste, whose

main components are Pb, Ag, Cd, In, Sn, and an organic binder.

*Fusible indium alloys* are usually based on bismuth in combination with lead, cadmium, tin, and indium.

Fusible indium alloys are used to bend thin-walled tubes without wrinkling the wall or changing the original cross section. The alloy is cast in the tube, rendering it effectively solid. After bending, the alloy can be melted out using hot water.

These alloys are also used in fire-control systems. Restraining links that hold alarm, water valve, and door operating mechanisms in place are soldered with a low-melting alloy. A rise in temperature sufficient to melt the alloy results in the system coming into operation.

Fusible alloys are used for making disposable patterns and dies for the founding of ferrous and non-ferrous metals.

They are also used as temperature indicators in situations where other methods of temperature measurement are impracticable. Small rods of alloys of known melting point are inserted into equipment such as aircraft header tanks, test bearings, and experimental rigs. The melting of the alloy thus indicates the temperature attained in particular parts of the test system.

Addition of indium to lead-tin *bearings* for heavy-duty and high-speed applications provides particularly high resistance to fatigue and seizure. These bearings are used in piston-type aircraft engines, high-performance automobile engines (formula 1) and in turbo-diesel truck engines.

The addition of indium to gold *dental alloys* improves their mechanical characteristics and increases resistance to discoloring. Small amounts of indium are used to improve the machinability of gold alloys for *jewelry*.

Indium is used in *nuclear reactor control-rod* alloys (80% Ag, 15% In, and 5% Cd). The consumption of indium in this field is estimated at 3.3 t/a for the replacement of control rods in existing nuclear power plants [9].

In *low pressure sodium lamps* (SOX lamps), indium is applied as a thin layer of in-

dium-tin oxide on the inside of the outer glass envelope. The indium-tin oxide film increases the operating temperature and the efficiency of the lamp. Low pressure sodium lamps, characterized by their orange color, are mainly used in the United Kingdom, Belgium, and the Netherlands. The production of SOX lamps accounts for 4-5 t/a indium [9].

Indium is now used as a corrosion inhibitor in *alkaline dry batteries* as a substitute for mercury. This allows the mercury content of the amalgamated zinc powder used in their production to be reduced from 7% to 1-3% [42]. Currently, a target of very low mercury content, or even complete removal, is being pursued. The low-mercury zinc powders have corrosion and degassing characteristics which are similar to those of the 7% mercury powders.

Indium orthoborate is used as a *phosphor* in *cathode-ray tubes*, where it is applied as a thin layer. Indium phosphors emit light for a longer time than zinc sulfide phosphors but are more expensive. They are used particularly in computer monitors where image stability is of great importance. In Japan, consumption of indium for this application was 6 t in 1986 and 8 t in 1987.

Intermetallic compounds of indium find application as *semiconductors*. The development of the second generation of optical fiber communication systems in the early 1980s with substantially lower levels of attenuation at wavelengths near the infrared region of 1.3  $\mu\text{m}$  and 1.55  $\mu\text{m}$  has led to the development of new semiconductor lasers and photodetectors. *Laser diodes* based on indium-gallium arsenide phosphide emit in the 1.27-1.6  $\mu\text{m}$  region. Indium-gallium arsenide *photodetectors* have high responsivity at 1.3 and 1.55  $\mu\text{m}$ .

The development of integrated circuits and opto-electronic integrated circuits based on indium is still in the research phase.

High-purity indium is used for laser diodes, photodetectors, and integrated circuits.

Charge coupled devices operating in the infrared region are based on indium antimonide. Infrared detectors and infrared video cameras, such as orthicons, use indium antimonide.

Thin films of indium-tin oxide are able to transfer electricity to light emitting or light reflecting elements. They find application in *liquid crystal displays* and to a lesser extent in electroluminescent displays and touch panels.

Minor uses of indium include thin plastic films coated with indium-tin oxide that are being developed for use in touch panels (e.g., for computer screens), liquid crystal devices, and electroluminescent lamps. Indium oxide is used as a coating for *glass*. Window glass coated with an indium-tin oxide film to reflect infrared radiation is being investigated. Indium oxide films doped with tin oxide are used to prevent icing and fogging on aircraft windshields. Their application as windshield coatings in automobiles is in development, particularly in Japan. Indium antimonide is used in *Hall generators* to measure magnetic fields. *Solar cells* based on copper-indium diselenide are being developed [43]. Small amounts of indium compounds are used as additives for *lubricating oils*, and to produce *yellow glass*.

**Table 36.5:** Estimated indium production in 1986 [9].

Country	Company	Production, t
Belgium	Metallurgie Hoboken-Overpelt	15
France	Peñarroya	19
Italy	Pertusola	
United Kingdom	Capper Pass Johnson Matthey	3 2
Netherlands	Billiton	1
Germany	VEB Preussag	1 1
Japan	Nippon Mining	16
China		6
Former Soviet Union		6
Peru	Centromin-Peru	4
Canada	Cominco	6
Total		80

### 36.10 Economic Aspects

The world production of indium in 1986 has been estimated at 80 t. Table 36.5 lists the estimated indium production by country and company for 1986. The main producers are located in Belgium, Japan, France, and Italy. Important indium refiners are located in the United States (Indium Corporation of Amer-



ica, 25 t in 1986 [9]) and the United Kingdom (Mining and Chemical Products, 10 t in 1986 [9]).

Figure 36.5 shows the evolution of the producer price for standard grade indium (99.97%) from the Indium Corporation of America. For indium of 99.99% purity, a premium of \$2–5/kg is charged. Very pure indium (7N or 99.99999%) costs ca. \$1500/kg [9].

### 36.11 Toxicology and Occupational Health

There is no evidence of any health hazard from industrial use of indium. No systemic effects in humans exposed to indium have been reported [44]. The TLV for indium is 0.1 mg/m<sup>3</sup>.

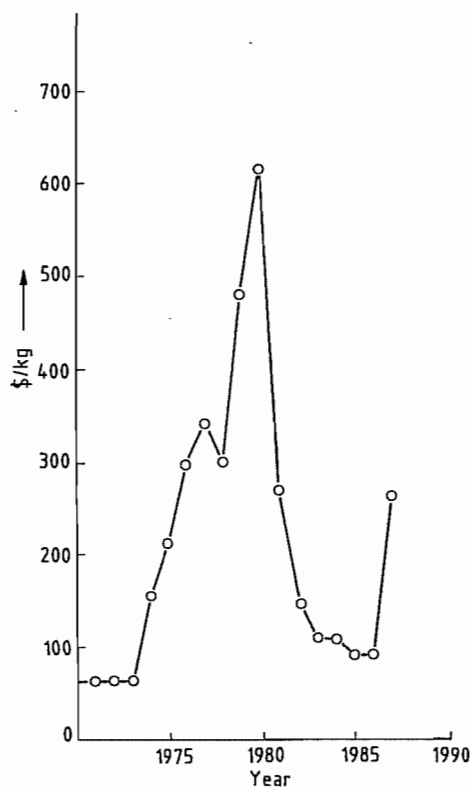

Figure 36.5: Evolution of the producer price for standard grade indium (99.97%) (Indium Corporation of America).

### 36.12 References

- H. E. Suess, H. C. Urey, *Rev. Mod. Phys.* **28** (1956) 56.
- F. Reich, T. H. Richter, *J. Prakt. Chem.* **89** (1863) 441.
- Kirk Othmer*, 3rd ed., **13**, p. 207.
- J. R. Mills, R. A. King, C. E. T. White: *Rare Metals Handbook*, 2nd ed., Chap 13, Reinhold Publishing Corporation, London 1961, p. 220.
- Ullmann*, 4th ed., **13**, 197.
- Handbook of Chemistry and Physics*, 62nd ed., The Chemical Rubber Co., Cleveland, OH, 1981/1982.
- J. C. Bailar et al.: *Comprehensive Inorganic Chemistry*, 1st ed., Pergamon Press, Oxford 1973, pp. 983–1117.
- J. W. Mellor, *A Comprehensive Treatise on Inorganic and Theoretical Chemistry*, vol. 5. Chap. XXXV, Longmans, Green and Co., London 1946.
- Roskill: *The Economics of Indium 1987*, 4th ed., Roskill Information Services Ltd., London 1987.
- E. Theurich, *Freiberg. Forschungsh.* **B90** (1963) 93.
- L. Müller, *Freiberg. Forschungsh.* **B90** (1963) 105.
- Anaconda Copper Mining Comp., US 2384610, 1940 (H. M. Doran et al.).
- R. Kleinert, "Indium from the Rammelsberg Ores", *Min. Mag.* **83** (1950) 146.
- Asarco, US 2433770, 1947 (Y. C. Lebedeff).
- S. Takayanagi, K. Yajhna, paper presented at the 22nd Annual Conference of Metallurgists of the Metallurgical Society of CIM, Edmonton, August 1983, paper no. 19.4.
- E. F. Milner, W. A. Van Beek, "Rotary furnace reduction of lead drossing fume for recovery of tin and indium", paper presented at the 24th Annual Conference of Metallurgists of the Metallurgical Society of CIM, Vancouver, August 1985.
- J. De Keyser, W. Jaspers, "The Harris Refinery of Metallurgie Hoboken-Overpelt", paper presented at the 110th AIME meeting, Chicago, Feb. 1981, AIME-TMS paper no. A-81-10.
- J. Coyle, *Trans. Electrochem. Soc.* **85** (1944) 223.
- T. Quarm, *Trans. Inst. Min. Metall.* **60** (1950) 77.
- Capper Pass Limited, GB 2109008A, 1982 (P. Halsall).
- P. Halsall, *Trans. Inst. Min. Metall. Sect. C* **97** (1988) 93.
- Preussag Aktiengesellschaft Metall, US 4666686, 1987 (W. Krajewski, K. Hanusch).
- Hazen Research, Inc. USA, CA 1188105, 1985 (E. Reynolds Jones, A. R. Williams).
- Cominco Ltd., CA 1218237, 1987 (R. Perri et al.).
- Tian Run-cang Zou Jia-yun, Zhou Ling-Zhi in M. J. Jones, P. Gill (eds.): *Mineral Processing and Extractive Metallurgy*, London IMM, 1984, pp. 615–624.
- Samim Societa Azionarva Minerio Metallurgica S.P.A., BE 902890, 1986 (R. Guerziero et al.).
- R. Guerziero, L. Meregalli, X. Zhang, *ISEC Int. Solvent Extr. Conf.*, Dechema, Frankfurt 1986, pp. 585–589.
- Nippon Mining, JP-KK 88016338, 1988.
- H. B. Linford, *Trans. Electrochem. Soc.* **79** (1941) 443.
- Oneida Community Ltd., US 1965251, 1934 (M. S. Murray, D. Gray).
- General Motors, US 2409983, 1946 (W. M. Martz).
- Indium Corporation of America, US 2458839, 1949 (J. R. Dyer, T. J. Rowan).
- G. S. Rao, G. H. Phatak, K. Gangadharan, *Indian J. Technol.* **12** (1974) 256.
- A. Arkady et al., US 4287030, 1981.
- U. Wiese, *Erzmetall* **34** (1981) no. 4, 190.
- Sumitomo Chem. Ind., JP-KK 204830, 1986.
- C. E. T. White, *Metal. Bull.* **47** (1977).
- Y. D. Liu, J. Verlinden, F. A. Lams, E. Adriaenssens, *Bull. Soc. Chim. Belg.* **95** (1986) 309.
- I. Barin, O. Knacke, O. Kubaschewski: *Thermochemical Properties of Inorganic Substances*, Springer Verlag, Berlin-Heidelberg-New York 1977.
- D. B. Winter, *Met. Bull.*, August 1988.
- Jpn. Ind. Rare Met. Ann. Rep.*, April 1988.
- M. Meeus, Y. Strauven, L. Groothaert, "Power Sources 11", *Proc. Int. Power Sources Symp.*, 15th, (1987) 281–299.
- C. E. T. White: *Advanced Materials & Processes Inc., Metal Progress*, December 1986, 69–72.
- L. Friberg, G. F. Nordberg, V. Vouk: *Handbook on the Toxicology of Metals*, Elsevier/North-Holland Biomedical Press, Amsterdam 1979, pp. 429–436.

## 37 Thallium

HEINRICH MICKE (§§ 37.1–37.10); HANS UWE WOLF (§ 37.11)

37.1 Introduction .....	1543	37.7 Alloys .....	1547
37.2 History .....	1543	37.8 Compounds .....	1548
37.3 Properties .....	1543	37.9 Analysis .....	1552
37.4 Occurrence .....	1544	37.10 Economic Aspects .....	1553
37.5 Extraction .....	1544	37.11 Toxicology and Occupational Health .....	1553
37.6 Uses .....	1547	37.12 References .....	1555

### 37.1 Introduction

Thallium [1–18], atomic number 81, is in group 13 of the periodic table, and has electronic structure  $1s^2 2s^2 2p^6 3s^2 3p^6 4s^2 3d^{10} 4p^6 5s^2 4d^{10} 5p^6 6s^2 6p^1$  [19]. It is a dense, fairly reactive metal, the fresh surface having a bluish-white luster. Thallium is softer than lead, but harder than indium, with a low *mp* 303 °C.

There are 20 known isotopes of thallium, of which two, atomic numbers 203 and 205, are relatively stable. The isotope  $^{204}\text{Tl}$  is used for materials testing.

The only thallium-containing substances of commercial importance are the metal itself and thallium sulfate. As thallium compounds are prohibited for insect pest control in the United States and parts of Europe, methods of extraction have not been improved during the last 10 years. Several European producers have stopped production of thallium and its compounds.

### 37.2 History

Thallium was discovered in 1861 by the Englishman CROOKES and in 1862 by the Frenchman LAMY, probably independently. During spectrographic examination of a lead chamber slime, CROOKES found a green line that could not be ascribed to any known element. He was convinced that he had discovered a new element, and gave it the name thallium after the Greek word  $\theta\alpha\lambda\lambda\omicron\varsigma$  a young

green branch. LAMY must have been the first person to isolate the element and establish its metallic character. A heated dispute over priority developed between the two investigators [20].

### 37.3 Properties

In many of its physical properties, thallium resembles its neighbor, lead. Its chemical behavior combines the properties of the alkali metals with those of silver, mercury, lead, and aluminum. Thallium is highly toxic.

**Chemical Properties.** Thallium is a very reactive metal. It oxidizes slowly in air, even at ca. 20 °C (more rapidly on heating), to thallium(I) oxide and thallium(III) oxide. Hydrogen peroxide and ozone oxidize the metal to thallium(III) oxide. In the presence of water, a hydroxide is formed. Thallium is therefore stored under petroleum spirit, glycerine, or de-aerated water. On prolonged storage under water with free access of air, metallic thallium becomes covered with large crystals of thallium(I) carbonate, and the water becomes saturated with this salt. To protect against oxidation, rods of thallium are coated with paraffin.

Thallium combines with fluorine, chlorine, and bromine at room temperature, and with iodine, sulfur, phosphorus, selenium, and tellurium on heating. Nitrogen, carbon, and molecular hydrogen do not react with the metal, which does not dissolve in liquid am-

monia. The metal is dissolved slowly by hydrochloric and dilute sulfuric acids, but more rapidly by nitric and concentrated sulfuric acids. Its slow reaction with hydrofluoric acid is noteworthy.

In the series of electrode potentials of cations, thallium has a similar normal potential to that of indium ( $Tl/Tl^+ -0.335$  V,  $In/In^{3+} -0.34$  V), lying between cadmium ( $Cd/Cd^{2+} -0.402$  V) and tin ( $Sn/Sn^{2+} -0.140$  V). Solutions of thallium(III) salts are not stable toward metallic thallium, reacting almost quantitatively:

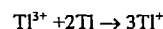

The electrode potential of  $Tl^+/Tl^{3+}$  is +1.21 V.

**Physical Properties.** Thallium is a soft metal (Brinell hardness 29.4 N/mm<sup>2</sup>, the value for lead being 39.2 N/mm<sup>2</sup>). Thallium exists in two allotropic crystal forms:  $\alpha$ -thallium, hexagonal close-packed, stable at room temperature; and  $\beta$ -thallium, body-centered cubic, stable above 226 °C. A volume increase of 3.23% takes place on solidification. On bending, the metal emits a creaking sound similar to the "cry" of tin. It has good cold forming properties and low strength. It can be melted and worked like lead. Physical properties are as follows [21, 22]:

Atomic number	81
Isotope abundance	
<sup>203</sup> Tl	29.52%
<sup>205</sup> Tl	70.48%
Density at 20 °C	11.85 g/cm <sup>3</sup>
Atomic volume	17.26 cm <sup>3</sup> /mol
Melting point	303.6 °C
Boiling point	1457 °C
Latent heat of fusion	30 J/g
Latent heat of vaporization at normal boiling point	800 J/g
Vapor pressure of melt, Torr	$\log p = -9300/T - 0.892 \log T + 11.1$
Thermal expansion of melt	3.1–4.3%/°C
Electrical resistivity at 2.38 K at 0 °C	superconducting
Specific magnetic susceptibility	$18 \times 10^{-6} \Omega \text{cm}$
Solid thallium	$-0.165 \times 10^{-6} \text{cm}^3/\text{g}$
$\beta$ -Thallium	$-0.158 \times 10^{-6}$
Molten thallium	$-0.22 \times 10^{-6}$
Surface tension	4.01 mN/cm
Tensile strength	9.8 kg/mm <sup>2</sup>
Relative elongation	135%
Brinell hardness	3 kg/mm <sup>2</sup>
Mohs hardness	1.2

Like mercury, lead, indium, etc., thallium can become superconducting, the average upper temperature limit being ca. 2.38 K [23]. Some compounds, e.g.,  $Tl_3Bi_5$ ,  $Tl_2Hg_5$ , and  $Tl_7Sb$  can also become superconducting [24]. It is especially valuable as a superconductor in ceramic materials at higher temperatures than are possible with other metals [25].

Vessels for containing liquid thallium can be made of Fe, W, Ta, Mo, Nb, and Co, in decreasing order of suitability.

## 37.4 Occurrence

Very variable figures are quoted for the concentration of thallium in the Earth's crust (1–3 ppm). It is said to be the 58th most abundant element [26]. In its occurrence, thallium shows a dual character. As a chalcophilic element, it occurs typically, though in low concentration, with the heavy metals that occur in sulfidic ores, usually associated with cadmium, mercury, indium, and germanium. Much more frequently, thallium accompanies the alkali metals potassium, cesium, and rubidium, where its concentration is also low, e.g., in carnallite, sylvine, leucite, lepidolite, feldspar, mica, etc. It is found in seawater, some mineral waters, and in native sulfur [1]. It also occurs in true thallium minerals, of which the following are the most common:

Lorandite	$TlAs_2S_2$
PirotPaulite	$TlFe_2S_3$
Chalcothallite	$Cu_3TlS_2$
Vrbaite	$Hg_3Tl_4As_8Sb_2S_{20}$
Hutchinsonite	$(Pb, Tl)_2(Cu, Ag)As_5S_{10}$
Bukovite	$Cu_{3+x}Tl_2FeS_{4-x}$
Wallisite	$PbTlCuAs_2S_3$
Hatchite	$PbTlAgAs_2S_3$
Crookesite	$(Cu, Tl, Ag)_2Se$
Avicennite	$7Tl_2O_3 \cdot Fe_2O_3$

The thallium content of these minerals is 16–85%. For many years, only five true thallium minerals were known. Because of their extreme rarity, these are of no importance for the extraction of the metal [27, 28].

## 37.5 Extraction

Although the amounts of thallium in ores, including those of lead and zinc, are small

compared with the amounts in salts, rock, etc., only the former play a significant role in the winning of the metal. They can be economically worked only if the thallium becomes concentrated in the side products in the course of processing the ore to obtain the main metal, and if other metals are present in this side product to an extent that justifies their extraction. Only a small part of the thallium that occurs naturally is therefore available for extraction.

Thallium is present only as a trace element in nonferrous metal concentrates. Only in a few smelting works does the thallium become sufficiently concentrated in particular process steps for extraction to be practical.

The following companies are thallium producers: Vieille Montagne, Belgium; Cimkent, Russia; Toho Zinc, Japan; Cerro de Pasco, Peru; Preussag, Germany.

Thallium produced as a by-product of the extraction of nonferrous metals is of only minor importance, both quantitatively and economically.

If the raw materials are in solution, the thallium is precipitated by cementation, and is then processed like a solid raw material. The following concentration processes can be used for the treatment of solid raw materials.

**Leaching and Precipitation.** The simplest process is leaching with water without pretreatment. With airborne dusts from lead or zinc smelting works, or cementation slimes, a yield of 85–90% of the thallium can be obtained. The thallium-containing liquor, which usually also contains cadmium and zinc, is filtered, precipitated with zinc amalgam, and the relatively pure metal is obtained by an electrolytic process (Figure 37.1) [31].

There are many methods of pretreating the starting material before leaching. These include:

- Oxidative roasting at 500 °C
- Sulfatization at 175–250 °C
- Alkaline pretreatment

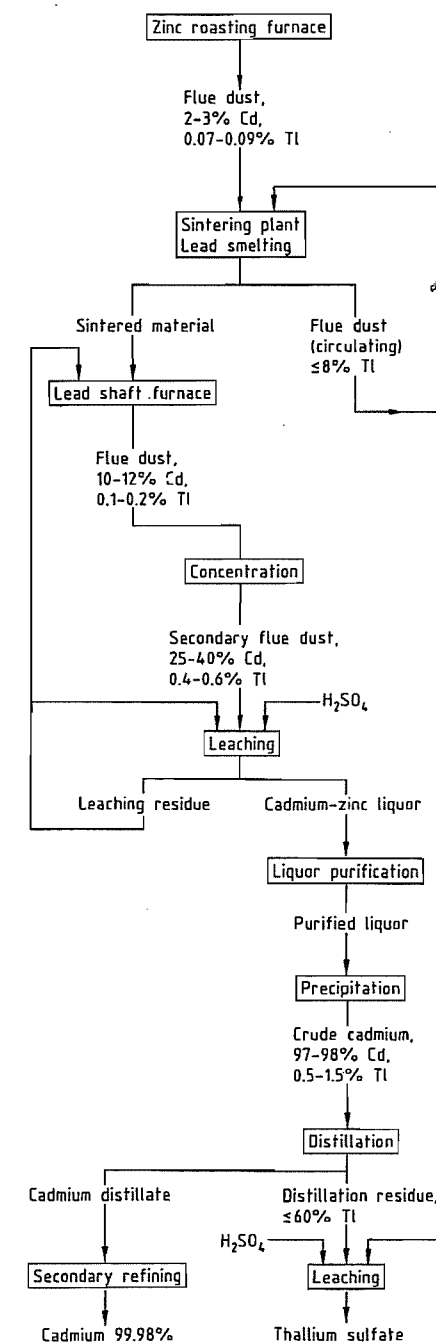

Figure 37.1: Simplified flow diagram of a plant for the combined recovery of cadmium and thallium sulfate from lead and zinc raw materials [29, 30].

Leaching of the raw material after pretreatment can extract 50–60% of the thallium. Flue dusts that contain bismuth, copper, zinc, iron, arsenic, cadmium, thallium, selenium, etc., are given an alkaline pretreatment (fusion with caustic soda and lead sulfide). The alkaline slag so formed is granulated with hot water. On cooling, sodium and thallium arsenates are precipitated, and processed to obtain the thallium [32].

The thallium is usually precipitated and recovered as a sparingly soluble salt (cementation thallium and thallium amalgam) from liquors produced in a variety of concentration methods, with and without pretreatment, and also from liquors that are themselves the raw materials.

Processing and refining of the precipitates obtained by cementation at the Duisburg copper refinery [33, 34] was discontinued in 1983.

**Volatilization.** In this process, crude arsenic containing 96%  $As_2O_3$  and 0.2% Tl is treated by adding 5%  $H_2SO_4$  and 5% lime and heating to 430 °C, causing 98% of the arsenic trioxide to be volatilized while 99% of the thallium remains in the residue. Sodium chloride is added, and the thallium is volatilized at 800 °C [33]. The volatilization process also gives good results with materials of complex composition from lead smelting. The secondary flue dust can be reprocessed. The most well-known process was that of the former company Zinkhütte Magdeburg [34].

**Electrorefining.** Electrorefining is operated in one or several stages, or as amalgam electrolysis. Depending on the purity of the starting metal and the operating conditions, thallium cathodes with variable thallium content (ca. 99.9–99.99% and above) are produced [35–37]. Metal of the highest purity can be obtained by multistage electrorefining, in which a perchlorate electrolyte containing 40–70 g/L  $TlClO_4$  and 60–120 g/L  $NaClO_4$  with small amounts of organic additives is used in the final stage. The current density is 0.3–0.6 A/dm<sup>2</sup>. The sum of all the impurities in the

metal is < 1 g/t, i.e., the thallium produced has a purity of 99.9999% [38].

Wet metallurgical refining is normally combined with the concentration process. The high solubility of thallium sulfate in water is used when lead and other metals that form insoluble sulfates are precipitated. The insolubility of thallium sulfide in alkaline solvents is used to separate it from the group 1 metals, and its solubility in dilute acids is used to separate it from silver, mercury, bismuth, copper, arsenic, antimony, cadmium, etc. The solution is treated with hydrogen sulfide, or preferably with freshly precipitated thallium sulfide, so that an easily handled thallium sulfate precipitate is produced at the end of all operations [39]. Iron and arsenic can be removed after oxidation with air followed by neutralization, e.g., by adding zinc oxide. The high solubility of thallium carbonate in water is used to separate it from zinc, iron, cadmium, and other impurities, usually in combination with a concentration process. The low solubility of thallium chromate is then used for both concentration and refining.

Very pure metal can also be obtained by fractional dissolution of the impure metal or by fractional precipitation, mainly by fractional cementation of the impurities and the thallium from impure solutions. Impure thallium metal or thallium amalgam can be used as the starting material. When thallium amalgam is heated with 70–100% sulfuric acid to boiling, the thallium dissolves first. If dissolution is interrupted after almost all the thallium, but none of the impurities, has gone into solution, the solution contains pure thallium sulfate which can be the raw material for metal winning [40].

To obtain compounds of the highest purity for use as intermediates for producing very high-purity metal, several unusual reactions have been proposed. These include precipitation of the thallium as cyclopentadienyl thallium [41, 42], or extraction of thallium(III) chloride,  $TlCl_3$ , from solution in hydrochloric acid (6–7 mol/L) with ether. First, however, the iron must be converted to the divalent form, and the heavy metals removed. Almost

complete removal of all impurities takes place by taking the impure starting substance into solution in hydrochloric, hydrobromic, or hydroiodic acid, and extracting the thallium complex with isopropyl ether at acid concentration 0.1–4 mol/L. The metal obtained by electrolysis of the purified compound has purity 99.9999–99.99999% [43].

During production of an ultrapure product from the already relatively pure metal by crystallization (especially zone melting and crystal pulling from the melt), the various impurities behave very differently. As well as the distribution coefficients, the operating conditions (mainly the migration rate of the zones and the crystallization rate) have a great influence on the refining. However, many other factors have an influence e.g., the rotation rate during zone melting, and the rotation rate of the seed crystal during crystal pulling from the melt. Secondary processes are also important, e.g., volatilization and oxidation of certain impurities. The behavior of some of the more common potential impurities for a given combination of operating conditions can make it difficult to obtain very pure end products.

Zone melting is generally carried out in graphite boats. The ingots used are 150–180 mm long, with a ca. 15 mm molten zone, the process being carried out in an atmosphere of purified nitrogen. With a zone migration rate of 0.5–1.0 mm/min and five passes, the copper content in most of the ingot can be reduced from 50 g/t in the starting metal to 2.7 g/t, and, under the same conditions, the silver content in approximately half the length of the ingot is reduced from 3 to < 0.3 g/t. By pulling crystals from the melt in vacuo (ca.  $10^{-2}$  Pa,  $10^{-4}$  mbar), crystals 100–220 mm long and 8–10 mm diameter can be obtained. With a crystallization rate of 0.4–0.5 mm/min, the manganese content is 0.2 g/t in the lower part and 0.1 g/t in the middle part of the crystal. After a second recrystallization, 0.05 g/t manganese is found in the middle and upper part.

Not all impurities can be removed by crystallization, e.g., lead and iron, and there is a group of impurities that can only be removed

by secondary processes. These include mercury, tin, and sulfur [44].

In Germany, thallium is produced solely by Preussag; annual production capacity is 4–5 t of 99.4–99.64% thallium [45]. Thallium is supplied as rods and granules in “4 nines” to “5 nines” quality (i.e., 99.99–99.999%). The catalogue also includes “pure” monovalent thallium compounds, including sulfate, bromide, chloride, and iodide. Other compounds can be produced on request.

## 37.6 Uses

No large application potential for thallium has so far been found. The unalloyed metal is unsuitable for direct use, owing to its unfavorable mechanical properties and marked tendency to oxidize. The radioactive isotope  $^{204}Tl$  is a  $\beta$ -emitter with half-life ca. 3.5 years, and is used as a radiation source in materials testing, principally for thickness measurements on metals and nonmetals. It has been discovered that  $^{205}Tl$  has the most constant atomic vibrations so far observed. This property has led to its use in atomic clocks.

These special applications require extremely pure grades. The very pure metal supplied by Unterharzer Berg- und Hüttenwerke contains > 99.999% Tl, i.e., the sum of all the impurities does not exceed 10 g/t [46]. American Smelting and Refining supply “high-purity thallium”, with the same purity. The following figures are quoted for the impurities [47]: Cu < 1 g/t; Pb 1 g/t; Fe < 1 g/t; Ag, Sn, Mg, and Si spectrographically undetectable, but < 1 g/t; other elements spectrographically undetectable.

## 37.7 Alloys

Thallium readily forms alloys with most other metals. There is complete mutual insolubility with iron, and limited solubility in the liquid state with copper, aluminum, zinc, arsenic, manganese, and nickel. The melting points of thallium lead alloys are higher than those of the pure metals, the maximum,

380 °C, being reached at 37.8% Pb. There is a resemblance to the two-component systems of lead, especially in alloys of thallium with copper, aluminum, zinc, and nickel. Gold, silver, cadmium, and tin form simple eutectics with thallium. Thallium also forms binary alloys with antimony, barium, calcium, cerium, cobalt, germanium, indium, lanthanum, lithium, magnesium, strontium, tellurium, and bismuth.

Alkali metals, alkaline earth metals, some metals of the rare earth group (e.g., lanthanum, cerium, praseodymium), and mercury form intermetallic compounds with thallium, some of which have unusually high melting points, e.g., CeTl (1240 °C) and PrTl (ca. 1150 °C). The compound with mercury, Hg<sub>5</sub>Tl<sub>2</sub>, has *mp* 14.5 °C and forms eutectics with thallium and mercury: Tl-Hg<sub>5</sub>Tl<sub>2</sub> with 40.45% Tl melts at 0.6 °C and Hg-Hg<sub>5</sub>Tl<sub>2</sub> with 8.5% Tl at -58.4 °C.

Of the systems with three or more components, the combinations with bismuth, lead, and cadmium have been much investigated. These have very low melting points over wide ranges, and in most cases form ternary or quaternary eutectics. For example, the melting point of the Bi-Pb-Tl eutectic with 11.5% Tl, 55.2% Bi, and 33.3% Pb is 90.8 °C, and the melting point of the quaternary B-Cd-Pb-Tl eutectic with 8.9% Tl, 44.3% Bi, 35.8% Pb, and 11.0% Cd is 81 °C [9].

The ternary alloys Tl-Pb-Bi, Tl-Al-Ag, In-Hg-Tl, Sn-Cd-Tl, Bi-Sn-Tl, and Bi-Cd-Tl are used as semiconductors or in ceramic compounds [48, 17].

The quaternary alloys Tl-Sn-Cd-Bi, Pb-Sn-Bi-Tl, and Pb-Cd-Bi-Tl are known [17].

Thallium, like tin, cadmium, lead, etc., has good wear resistance when used in bearings for steel shafts. As additions of thallium also increase the deformation resistance, breaking strength, yield, strength, and hardness of lead and its alloys, thallium-containing alloys are frequently recommended for bearings [49]. The alloy 72% Pb, 15% Sb, 5% Sn, and 8% Tl is superior to the best tin-based bearing metals with respect to yield strength and breaking strength. Bearing metals based on

Pb-Tl-Cd with high cadmium content can have compositions in the range 0.01–5% Tl, 5–40% Cd, the rest being Pb [47]. However, thallium has since been replaced by indium as an alloy constituent [45].

Addition of thallium to gold, silver, and copper contacts in the electronics industry (e.g., 0.05–20% Tl added to copper alloys) reduces the tendency to sticking [45].

In solid-state rectifiers, especially selenium rectifiers, addition of thallium increases the blocking resistance [50].

Addition of thallium can reduce the melting point of mercury from -39 °C to ca. -59 °C. One use for this low-melting Hg-Tl alloy is for low-temperature thermometers [51].

The increase in the melting point of lead by addition of thallium is used in special types of electrical fuses and in solder (thallium content ≤ 20%) where a higher melting point is required [5, 6].

## 37.8 Compounds

Thallium can be monovalent or trivalent, the stability of the 6s electron pair in the electronic structure making thallium preferentially monovalent in inorganic compounds. Thallium(I) compounds have a certain similarity to alkali metal compounds, e.g., high solubility of the sulfate, carbonate, and hydroxide in water. However, they also show similarities to compounds of silver, mercury, and lead, e.g., low aqueous solubility of the chloride, bromide, iodide, and sulfide.

**Thallium(I) oxide**, Tl<sub>2</sub>O, is formed by heating thallium in air at < 100 °C, or by dehydration of TlOH. It is reddish-black to black, volatile in air at higher temperatures, being converted to Tl<sub>2</sub>O<sub>3</sub>, and is very hygroscopic, forming a colorless, alkaline solution of TlOH with water. The enthalpy of formation is given by:

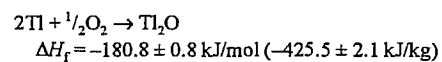

With B<sub>2</sub>O<sub>3</sub>, borates, or mixtures of borates and fluorides of alkali and alkaline earth metals, Tl<sub>2</sub>O forms stable, clear, homogeneous

melts which can be used for the electrolytic production of metallic thallium.

**Thallium(III) oxide**, Tl<sub>2</sub>O<sub>3</sub>, is more stable, and can be formed by heating Tl<sub>2</sub>O to > 100 °C, treating thallium(III) salts with KOH or NH<sub>3</sub>, or treating thallium(I) salts with oxidizing agents, e.g., TlCl with NaOCl. It is brown to black, forms cubic crystals with density (4–21 °C) 9.65 g/cm<sup>3</sup>, *mp* 717 ± 5 °C, and begins to sublime above 500 °C with partial decomposition:

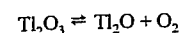

It can be reduced to Tl<sub>2</sub>O, and even to the metal, by strongly heating with hydrogen, carbon, or carbon dioxide. It reacts very vigorously with sulfur and hydrogen sulfide, even at room temperature, doubtless in accordance with the equations:

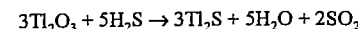
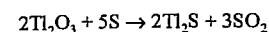

Treatment of an aqueous suspension with sulfur dioxide leads to Tl<sub>2</sub>SO<sub>4</sub>:

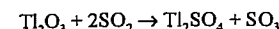

It is sparingly soluble in water, but does not form a hydroxide. It dissolves in hydrochloric, sulfuric, and nitric acids with formation of hygroscopic, unstable thallium(III) salts, from which it is precipitated unchanged by alkali. It is also dissolved by acetic and tartaric acids. With oxalic acid, the sparingly soluble oxalate is formed, which decomposes on heating:

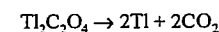

**Thallium(I) hydroxide**, TlOH (92.32% Tl), is formed on heating metallic thallium with water in the presence of air, or dissolving Tl<sub>2</sub>O in water. It is white, becoming dark gray on exposure to light. Its enthalpy of formation is given by:

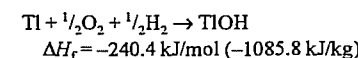

It dissociates to Tl<sub>2</sub>O and H<sub>2</sub>O on heating above 139 °C.

It is soluble in water, forming a colorless markedly alkaline solution which rapidly absorbs O<sub>2</sub> from the air, with formation of

Tl<sub>2</sub>CO<sub>3</sub>, and rapidly oxidizes, forming Tl<sub>2</sub>O<sub>3</sub>. The aqueous solution is a stronger base than NaOH, attacking glass very strongly on heating. Sodium sulfide precipitates Tl<sub>2</sub>S:

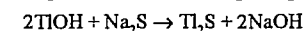

**Thallium(I) chloride**, TlCl, is formed when HCl or alkali metal chlorides are added to neutral thallium(I) salt solutions. The precipitated product is sparingly soluble in water, and is of some metallurgical importance. It is white, becoming gray-brown to blackish-brown on exposure to light. It forms cubic crystals, density 7.00–7.05 g/cm<sup>3</sup>, *mp* 427 °C, *bp* 806 °C, initial sublimation temperature ca. 360 °C, specific heat capacity *c<sub>p</sub>* (2.8–45.3 °C) = 0.221 Jg<sup>-1</sup>K<sup>-1</sup>. The enthalpy of formation is given by:

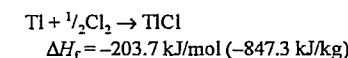

No thermal decomposition takes place at the melting point. On heating in a stream of chlorine, it is first converted to 3TlCl·TlCl<sub>3</sub>, and then to TlCl<sub>3</sub>. On melting with NaHSO<sub>4</sub>, it is converted to Tl<sub>2</sub>SO<sub>4</sub>:

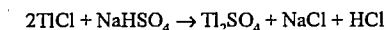

Metallic thallium is liberated on melting with alkali metal cyanides, or zinc:

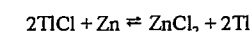

It is very sparingly soluble in water, 0.29 g dissolving in 100 g H<sub>2</sub>O at 15.6 °C, and 2.41 g at 99.35 °C. It reacts with a dilute solution of Na<sub>2</sub>SO<sub>4</sub> to form Tl<sub>2</sub>SO<sub>4</sub>:

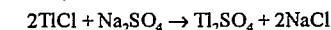

On heating with H<sub>2</sub>SO<sub>4</sub>, Tl<sub>2</sub>SO<sub>4</sub> or TlHSO<sub>4</sub> are formed (see above). HNO<sub>3</sub> reacts in the cold to form 2TlCl·TlCl<sub>3</sub>, and, on heating, the very soluble TlCl<sub>3</sub> (with some TlNO<sub>3</sub>), in accordance with the approximate equation:

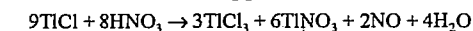

On treatment with a 20% solution of Na<sub>2</sub>CO<sub>3</sub>, Tl<sub>2</sub>CO<sub>3</sub> is formed, which is converted to TlCl on addition of NaCl:

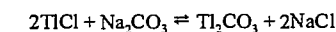

It reacts with ammonium sulfide to form Tl<sub>2</sub>S:

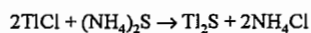

and with sodium hypochlorite to form  $\text{Tl}_2\text{O}_3$ :

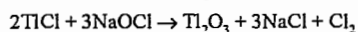

With  $\text{CdCl}_2$ ,  $\text{TlCl}$  forms a sparingly soluble double salt,  $\text{TlCl} \cdot \text{CdCl}_2$ , which decomposes again on boiling with water.

**Thallium(I) iodide**,  $\text{TlI}$ , is formed by direct combination of the elements or by precipitation from thallium(I) salt solutions by addition of alkali metal iodide. There are two modifications: a yellow rhombic form stable at room temperature, and a red cubic form stable above ca. 165 °C. The yellow form has density 7.1 g/cm<sup>3</sup> and the red form 7.45 g/cm<sup>3</sup>, *mp* 440 °C, *bp* 824 °C. Sublimation starts at 355 °C. The specific heat capacity in Jg<sup>-1</sup>K<sup>-1</sup> is given by  $c_p = 0.152T + 3.43$ . The enthalpy of formation is given by

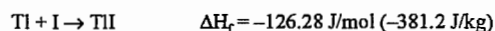

Metallic thallium is liberated on melting with alkali metal cyanides. The following reaction takes place with sodium sulfide:

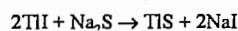

Its solubility in water is considerably less than that of  $\text{TlCl}$ , but is increased by addition of  $\text{KOH}$ . It is not attacked by sulfuric and hydrochloric acids, but nitric acid (dilute or concentrated) reacts with liberation of iodine.

**Thallium(I) fluoride**,  $\text{TlF}$ , is very soluble in water, unlike the other thallium(I) halides, the solution is alkaline.

**Thallium(I) sulfide**,  $\text{Tl}_2\text{S}$ , is formed on melting together thallium and sulfur (along with  $\text{Tl}_2\text{S}_5$ , depending on the mixing ratio). It is also precipitated from thallium(I) salt solutions on adding  $(\text{NH}_4)_2\text{S}$ , or an amorphous precipitate is formed when  $\text{H}_2\text{S}$  is added to very weakly acid solutions. This becomes crystalline on heating to 150–200 °C with a solution of  $(\text{NH}_4)_2\text{S}$ . From thallium(III) salt solutions, a mixture of  $\text{Tl}_2\text{S}$  and sulfur is precipitated.  $\text{Tl}_2\text{S}$  is also formed when a solution of  $\text{Tl}_2\text{SO}_4$  is heated with  $\text{Na}_2\text{S}_2\text{O}_3$ . It is black, and the crystals have a blue metallic luster. Its density is 8.4 g/cm<sup>3</sup>, and its melting point 448 °C. It vaporizes on heating above 300 °C,

at first unchanged, but decomposing at higher temperatures (e.g., 900 °C). The enthalpy of formation is given by:

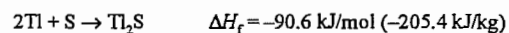

Precipitated  $\text{Tl}_2\text{S}$  is readily oxidized in air to  $\text{Tl}_2\text{SO}_4$ . It is sparingly soluble in water and almost insoluble in alkaline solvents, but dissolves in boiling mineral acids (dilute  $\text{H}_2\text{SO}_4$  and  $\text{HNO}_3$ ). Reaction with fuming nitric acid leads to the sulfate:

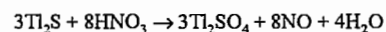

The other sulfides ( $\text{Tl}_2\text{S}_3$ ,  $\text{Tl}_2\text{S}_5$ ) become increasingly insoluble as the sulfur content increases, and are converted to  $\text{Tl}_2\text{S}$  with liberation of sulfur on heating.

**Thallium(I) sulfate**,  $\text{Tl}_2\text{SO}_4$  (80.97%  $\text{Tl}$ ), is the most important starting material for thallium metal winning. Depending on its method of manufacture, it forms colorless, very lustrous rhombic crystals or a snow-white crystalline powder, density 6.765 g/cm<sup>3</sup>, *mp* 632 °C. It vaporizes unchanged at white heat. Above 900 °C, its vapor pressure increases rapidly. During the roasting of zinc concentrates (900 °C) and the sintering of lead concentrates (1000 °C), a considerable amount of thallium can volatilize as its sulfate. The effect of temperature on the vapor pressure can be approximately represented by:

$$\log p = -\frac{9300}{T} - 0.892 \log T + 11.1$$

where  $p$  is in Torr (1 Torr = 133 Pa);  $T$  is in K. The enthalpy of formation is given by:

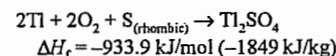

It is very soluble in water, e.g., 100 g boiling water dissolves 18.45 g  $\text{Tl}_2\text{SO}_4$ . The solution is hardly hydrolyzed, and is therefore neutral. Addition of hydrochloric acid or alkali metal chlorides to the solution precipitates sparingly soluble  $\text{TlCl}$ , though never completely:

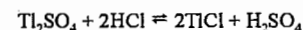

Potassium iodide addition can give complete precipitation:

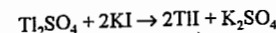

Addition of sodium thiosulfate at the boiling point produces  $\text{Tl}_2\text{S}$ :

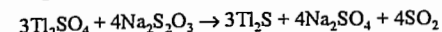

With excess sodium carbonate, partial hydrolysis of the  $\text{Tl}_2\text{CO}_3$  formed, and oxidation of the  $\text{TlOH}$ , produces a black precipitate. Addition of  $\text{Na}_2\text{Cr}_2\text{O}_7$  or  $\text{Na}_2\text{CrO}_4$  produces sparingly soluble  $\text{Tl}_2\text{CrO}_4$ , which can be redissolved to  $\text{Tl}_2\text{SO}_4$  and  $\text{CrSO}_4$  by treatment with dilute  $\text{H}_2\text{SO}_4$  and  $\text{NaHSO}_4$ . Treatment of  $\text{Tl}_2\text{SO}_4$  with  $\text{H}_2\text{SO}_4$  or treatment of  $\text{TlCl}$  with excess  $\text{H}_2\text{SO}_4$  gives thallium(I) hydrogen sulfate,  $\text{TIHSO}_4$ , or  $\text{Tl}_2\text{SO}_4 \cdot \text{H}_2\text{SO}_4$ , which melts at 115–120 °C and is converted to neutral  $\text{Tl}_2\text{SO}_4$  with liberation of  $\text{SO}_3$  by strong heating.

**Thallium(I) nitrate**,  $\text{TlNO}_3$ , is formed when metallic thallium or  $\text{Tl}_2\text{CO}_3$  is dissolved in  $\text{HNO}_3$ . It is white, and forms rhombic crystals (a cubic modification is also known), density 5.55 g/cm<sup>3</sup>, *mp* 206 °C. It melts without decomposition, but decomposition begins at ca. 300 °C, and is complete at 450 °C:

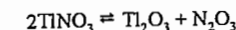

The enthalpy of formation is given by:

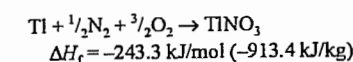

It is very soluble in water, the solubility increasing very rapidly with temperature, 100 g  $\text{H}_2\text{O}$  dissolving 7.93 g  $\text{TlNO}_3$  at 15.4 °C and 593.93 g at the boiling point. Its solutions are neutral.  $\text{H}_2\text{SO}_4$  reacts with  $\text{TlNO}_3$  to form  $\text{Tl}_2\text{SO}_4$ .

**Thallium(I) carbonate** is formed by the action of  $\text{CO}_2$  on  $\text{TlOH}$ , or by reacting thallium(II) salt solutions with an alkali or alkaline earth hydroxide, e.g.,  $\text{Ba}(\text{OH})_2$ , while passing  $\text{CO}_2$  into the solution.

It is white, and forms monoclinic crystals, density 7.164 g/cm<sup>3</sup>, *mp* 272 °C, decomposing at elevated temperatures. The  $\text{Tl}_2\text{O}$  thus formed is soluble in molten  $\text{Tl}_2\text{CO}_3$ , and is converted to  $\text{Tl}_2\text{O}_3$  on prolonged heating.

The enthalpy of formation is given by:

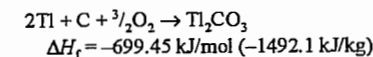

It is fairly soluble in hot water (27.78 g  $\text{Tl}_2\text{CO}_3$  dissolves in 100 g  $\text{H}_2\text{O}$  at 100 °C). On dilution, rapid hydrolysis takes place with formation of  $\text{TlOH}$ , so that the solution is alkaline. It is rapidly decomposed by acids.

**Thallium metasilicate**,  $\text{Tl}_2\text{SiO}_3$ , is obtained by treatment of thallium(I) hydroxide with sodium metasilicate,  $\text{Na}_2\text{SiO}_3$ , dissolved in a solution of  $\text{NaNO}_3$ . The orthosilicate,  $\text{Tl}_4\text{SiO}_4$ , is prepared by reacting thallium(I) hydroxide with sodium orthosilicate,  $\text{Na}_4\text{SiO}_4$ . Both silicates are water soluble. Solid vitreous thallium silicate has a high refractive index.

The total quantity of thallium compounds in Germany does not exceed 500 kg (based on thallium metal), and is distributed in laboratories, universities, and research institutes.

**Glasses and Single Crystals.** Glasses composed of the three-component systems As–Tl–S and As–Tl–Se may be prepared by melting the elements together. They are very mobile liquids, even below 400 °C. Viscosity as low as 3 Pa·s has been observed at 250 °C for a composition of, e.g., 25% As, 45% Tl, and 30% S. The glasses are chemically very stable, and insoluble in dilute acids. They are very slightly attacked by alkalis. The electrical resistivity is ca.  $10^6$ – $10^{18}$  Ωcm. The glasses have good wetting properties toward many metals, and are extremely impervious. They are therefore suitable for hermetically sealing sensitive electrical equipment (capacitors, resistors, semiconductors, etc.) to protect them from moisture and atmospheric effects. The glasses can be vaporized in vacuo and directly condensed onto the article to be coated [52].

The properties of photochromic glass can be improved by the addition of 0.2–4% thallium (as  $\text{TlCl}$  added to  $\text{AgCl}$ ).

Single crystals of three-component systems, e.g.,  $\text{Tl}_3\text{VS}_4$ ,  $\text{Tl}_3\text{NbS}_4$ , and  $\text{Tl}_3\text{PSe}_4$ , are used in acoustical optical measuring equipment, e.g., laser modulators [53].

In the manufacture of quartz single crystals, Tl compounds can provide wavelength selection (optical windows) [54].

**Uses.** Since the 1970s, it has not been permitted to use thallium compounds for insect pest control in Europe and the United States, so that they are now sold only for special applications. Thallium compounds have also been proposed for impregnating wood and leather to kill fungal spores and bacteria, and for the protection of textiles from attack by moths. A solution of 0.2 g thallium(III) sulfate in 1 L water is suitable both for wood impregnation and seed treatment.

In the manufacture of ethylene oxide, catalysts containing 1 mmol Tl per kilogram catalyst have certain advantages [55]. When recycling polyurethanes at 120–200 °C,  $Tl_2O_3$  0.01 mol/L and catalysts are added to the solutions [56].

Not only colloidal thallium metal, but also its compounds, especially the benzoate, oleate, and amyl alcoholate have been proposed as antiknock agents for internal combustion engines. These compounds are added to the fuel as insoluble suspensions or soluble compounds, or are introduced into the cylinders in other ways [57].

Binary mixed crystals of thallium halides, especially  $TlBr-TlI$  and  $TlCl-TlBr$ , are highly transparent in the infrared. They are used for the manufacture of plates, prisms, and lenses for infrared instruments [8].

Addition of thallium to the filling materials of high-pressure mercury vapor lamps improves light emission considerably. If thallium iodide is used in place of the metal, provided that certain operating conditions are observed, the spectrum can be modified, i.e., the shade can be corrected [58]. Thallium salts are also added to fluorescent materials as activators.

Thallium(I) sulfide is one of the most important photoconductors, and is used in the manufacture of photocells. These are mainly constructed as barrier layer photoconductive cells, i.e., the resistance of the cell is reduced by absorption of light. The cells are especially sensitive in the long wavelength visible and near infrared, and are superior to selenium cells at low radiation intensities [59].

**Environmental Aspects.** As the natural concentration of thallium in the Earth's crust is 1–3 ppm, it does not constitute a danger to groundwater or rivers (Rhine water, 2 ppb). The most important sources of air pollution are smelting and roasting plants for iron and nonferrous metals, and lignite power stations. Over 95% of the Tl is retained in cyclones and hot electrostatic filters [18]. The total thallium content of all the lignite used in Germany is 1.7 t/a. Of this, 95% is retained in the ash, and only 5% is released to the atmosphere (at an exhaust gas concentration  $< 1 \mu\text{g}/\text{m}^3$ ).

### 37.9 Analysis

The quantitative determination of thallium is carried out with the aid of the grass-green coloration of the flame, and the spectral line at 535.1 nm, which is easily distinguished from the barium band at 534.7 nm by its sharpness and intensity. There are several wet chemical methods: precipitation of the monovalent ion by hydrochloric acid; the very sensitive reaction with potassium iodide to bright yellow thallium iodide (minimum detectable Tl concentration 1 in  $3 \times 10^5$ ); precipitation from neutral solution as the yellow chromate,  $Tl_2CrO_4$ ; or, the most sensitive detection method, precipitation with thionalide as a lemon-yellow complex (concentration limit 1 in  $10^7$ ).

Quantitative gravimetric determination is by precipitation as thallium(I) iodide or chromate. The reaction:

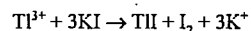

is used for volumetric determination, the liberated iodine being titrated against thiosulfate after addition of starch.

The Blumenthal permanganate precipitation is used to concentrate traces of thallium, ether being used to extract  $Tl^{3+}$  ( $Tl^+$  cannot be extracted quantitatively with ether).

For the determination of thallium in the microgram and nanogram regions, atomic absorption spectrometry is used, by flame atomic absorption or flameless techniques. Optimal limits of detection are:

- Solid samples (ores, earth samples, dusts, etc.), 0.5 ppm
- Aqueous samples, 0.001 mg/L
- Biological materials, 0.004 ppm [60]

Field desorption mass spectrometry (FD-MS) enables detection and quantitative determination of metallic cations from biological samples and environmental samples in the picogram range, without a separate conversion to ash. With this new technique for the determination of trace and ultratrace quantities, the limits of detection for thallium are ca.  $10^{-11}$  g. The extreme specificity of FD-MS makes elaborate sample preparation unnecessary, except for the tissue and cell components of samples, which must be homogenized and centrifuged; the time required per analysis is only ca. 20 min. The sample size need be only ca. 1 mg [61].

### 37.10 Economic Aspects

The limited demand can be fully met by suppliers, as the total world demand in 1988 was only ca. 6–8 t. No increase is expected for either the metal or its compounds. Annual production in 1975 was 15 t. The amount of thallium available annually from raw materials used in metal refineries is currently estimated as  $> 600$  t/a.

The price of the metal has increased tenfold since 1975, and is currently ca. US\$170/kg. The price of the 99.999% metal is ca. US\$350/kg [62].

### 37.11 Toxicology and Occupational Health [64–66]

Thallium is a well-known, highly effective poison. Intoxications occurred in former times due to its use as a medicinal agent for many diseases such as venereal disease, dysentery, and tuberculosis. Another main source of accidental, suicidal, and homicidal exposures was its use as a rodenticide which, however, has been banned during the last decades in many countries. Thallium may be accumulated in mushrooms.

The toxicological significance of thallium is mainly restricted to some inorganic and organic salts of  $Tl^+$  such as  $TlCl$ ,  $Tl_2SO_4$  (used as a rodenticide [67]), and thallium acetate. Intoxications by elemental thallium are comparatively rare. There is some evidence that, analogously to mercury,  $Tl^{3+}$  can be converted in the environment to methylated compounds by microbial action [68], and thus represents a potential cumulative hazard.

**Toxicokinetics.**  $Tl^+$  ions are readily absorbed from the gastrointestinal tract and distributed into various tissues, resulting in high concentrations in kidneys, myocardium, testes, salivary glands, intestine, skeletal muscle, thyroid and adrenal glands. Uptake of thallium-containing dusts via the respiratory tract results in increased thallium toxicity. Transdermal absorption is also possible, especially after the use of thallium-containing ointments. Thallium ions are able to cross the placental barrier and can produce nail abnormalities and alopecia in fetuses exposed during the last trimester [69]. Thallium ions do not undergo metabolic reactions comparable to those of organic xenobiotics (e.g., hydroxylation and conjugation reactions).

Excretion of  $Tl^+$  ions after strong acute intoxication mainly occurs via the feces. Due to pronounced enterohepatic circulation, the excretion half-life varies widely in the range 1.7–30 d. Only 3% of the entire body burden is excreted per day in the urine [64, 70].

The mechanism of toxicity is not completely understood. There is evidence for interaction of  $Tl^+$  ions with thiol groups, resulting in reactions with a variety of proteins and in inhibition of enzymes such as succinic dehydrogenase. The exchange of the activating  $K^+$  ion by the nonactivating  $Tl^+$  ion leads to inhibition of  $Na^+$ ,  $K^+$ -ATPase. Furthermore,  $Tl^+$  is stored in axonal mitochondria, resulting in their destruction [71].

**Acute and Chronic Toxicity.** The most prominent and characteristic features of acute, subchronic, and chronic thallotoxicosis are seen in the nervous system, skin, and cardiovascular system. Concerning the clinical presenta-

tion, the time course for the development of symptoms can be divided into four stages [65, 72]:

- *During 3–4 h* onset of predominantly gastrointestinal symptoms such as nausea, vomiting, and diarrhea occurs. In severe cases, hematemesis may occur.
- *Within hours to days* various severe symptoms of the CNS (e.g., disorientation, coma, convulsions, psychosis, cerebral edema with central respiratory failure), PNS (combined motor and sensory neuropathy, including severe hyperesthesia of palms and soles), and ANS (tachycardia, hypertension, fever, salivation, and sweating) develop. Symptoms of the cardiorespiratory system, which may predominate in severe cases, include myocardial necrosis with dysrhythmia and pump failure, hypotension, and bradycardia. Skin symptoms include blue-gray lines on gums, dark pigmentation around the hair roots, and acne. The ophthalmologic symptoms are optic neuritis and ophthalmoplegias.
- *During 2–4 weeks* the skin becomes dry and scaly, and white stripes across the nails (Mees's lines), and scalp and facial hair loss appear as characteristic signs.
- *During several months* various CNS and PNS abnormalities such as ataxia, tremor, foot drop, and memory loss may persist.

**Genotoxicity.** Chromosome aberrations and an increased frequency of DNA breaks were found in embryonic cell cultures. After chronic thallium exposure, precancerous lesions in the female genital tract occurred in mice [64, 73].

**Reproductive Toxicity.** The reproductive system is highly susceptible to thallium toxicity; in humans some of the highest concentrations have been found in the testes after Tl poisoning [64]. Thallium has been shown to produce teratogenic effects in chick embryos, including achondroplasia, leg bone curvature, parrot beak deformity, microcephaly, and reduced fetal size; the results of teratological investigations in rats, mice, and cats are conflicting [73].

**Toxicological Data and Analysis.** The average lethal dose of thallium salts is ca. 1 g for adults (ca. 10–15 mg/kg body weight). Low blood thallium levels are only an indication on the degree of an intoxication to be drawn. However, levels above 300 µg/L blood or 100 µg/L urine indicate severe intoxication (0.3 µg/L urine is the average level in unexposed persons). Moreover, the incorporation of thallium into scalp hair is of analytical significance, 7–15 ng/g hair being the normal range.

**Treatment.** Decontamination of the gastrointestinal tract such as by use of syrup of ipecac, lavage, serial doses of charcoal, and use of cathartics are useful during the first few hours after ingestion. Since thallium occurs as a monovalent cation, chelating agents used for the enhancement of excretion such as dithiocarb, CaNa<sub>2</sub>EDTA, BAL (British anti-Lewisite, dimercaprol, 2,3-dimercaptopropanole), and penicillamine are not effective. The combination of hemodialysis (protecting the kidneys) and potassium diuresis has been recommended in the case of severe poisoning. However, hemoperfusion clearance seems to be superior to hemodialysis clearance.

Prussian blue, potassium ferricyanoferrate, in daily doses up to 24 g (combined with a mild cathartic) may be used to interrupt the marked enterohepatic circulation by exchanging Tl<sup>+</sup> for K<sup>+</sup>. The resulting compound cannot be absorbed and therefore causes only minor side effects [71]. Moreover, it does not liberate substantial amounts of cyanide.

**Occupational Health.** The MAK value is 0.1 mg/m<sup>3</sup> soluble Tl compounds measured as total dust. In the United States and the United Kingdom the TLV-TWA is 0.1 mg/m<sup>3</sup>.

Occupational diseases caused by thallium are included in the list of the German Berufskrankheitenverordnung (Occupation Disease Regulations).

Since thallium tends to accumulate, persons exposed at the workplace should be monitored adequately even in cases of low chronic exposure.

## 37.12 References

1. Gmelin, Thallium, system no. 38. *Ullmann*, 3rd ed., 17, 299.
2. J. De Ment, H. C. Dake: *Rarer Metals*, Temple Press, London 1949.
3. N. Lowitzki: "Neueres Schrifttum über Thallium aus den Jahren 1938–1948", *Z. Erzbergbau Metallhüttenwes.* 3 (1950) 201.
4. H. E. Howe, A. A. Smith, Jr.: "Properties and uses of Thallium", *J. Electrochem. Soc.* 97 (1950) 167C.
5. L. Sunderson: "Thallium", *Can. Min. J.* 65 (1944) 624.
6. W. H. Waggaman, G. G. Heffner, E. A. Gee: "Thallium", US Dept. of the Interior, Bureau of Mines Information Circular 7553, 1950.
7. V. Tafel: *Lehrbuch der Metallhüttenkunde*, vol. 2, Hirzel, Leipzig 1953.
8. D. E. Eilertsen: "Thallium, Mineral Facts and Problems", US Dept. of the Interior, Bureau of Mines, Bulletin 585, 1960.
9. C. A. Hampel: *Rare Metals Handbook*, Reinhold Publ., New York 1961.
10. W. Schreiter: *Seltene Metalle*, vol. 3, VEB Deutscher Verlag für Grundstoffindustrie, Leipzig 1962.
11. R. Kleinert: "Thallium, ein seltenes Metall, ein Begleitmetall", *Erzmetall* 16 (1963) 67.
12. R. Kleinert: "Die Verwendung von Thallium", *Erzmetall* 18 (1965) 363.
13. A. G. Lee: *The Chemistry of Thallium*, International Idens. Inc., Philadelphia 1974.
14. H. R. Babitzke: "Thallium, Mineral Facts and Problems", US Dept. of the Interior, Bureau of Mines, Bulletin 667, 1975.
15. W. W. Stanzo, M. B. Tschernenko: *Die chemischen Elemente Antimon–Wismut, Bausteine der Erde*, vol. 3, Verlag MIR, Moskau, Urania Verlag, Leipzig 1976.
16. R. J. De Filippo: "Thallium, Commodity Data Summaries", US Dept. of the Interior, Bureau of Mines, 1977.
17. J. C. Smith, B. L. Carson: *Trace Metals in the Environment*, vol. 1, Ann Arbor Sci. Publ., Ann Arbor, MI, 1977.
18. Abfallwirtschaft Forschungsbericht 10301327 des Bundesministers des Innern, Germany.
19. F. A. Cotton, G. Wilkinson: *Anorganische Chemie*, 2nd ed., Verlag Chemie, Weinheim 1970.
20. E. Pilgrim: *Entdeckung der Elemente*, Mondus, Stuttgart 1950.
21. W. Schreiter: *Seltene Metalle*, VEB Deutscher Verlag für Grundstoffindustrie, Leipzig 1960.
22. J. Fischer: "Die Dampfdruckkurve des Thalliums", Festschrift der TH Breslau, Verlag Korn, Breslau 1935.
23. W. Meißner, H. Franz, H. Westerhoff, *Ann. Phys. (Leipzig)* 13 (1932) 555.
24. C. J. Smithells: *Metals Reference Book*, Butterworth, London 1962.
25. *Am. Ceram. Soc. Bull.* 68 (1989) no. 5, 1070.
26. B. Mason: *Principles of Geochemistry*, Wiley, New York 1958.
27. P. Ramdohr: *Die Erzminerale und ihre Verwachsungen*, Akademie Verlag, Berlin 1960.
28. K. H. Wedepohl: *Handbuch der Geochemie*, Element 81, vol. 2, no. 3, Springer Verlag, Berlin 1972.
29. J. Feiser, *Erzmetall* 15 (1962) 578.
30. J. Feiser, personal communication, 1963.
31. M. T. Koslovskij et al., *Tr. Inst. Khim. Nauk Akad. Nauk Kaz. SSR* 3 (1958) 5.
32. Z. A. Serikov, S. M. Anisimov, *Izv. Vys. Uchebn. Zaved. Chern. Metall.* 3 (1960) no. 6, 65.
33. I. D. Prater, D. Schlain, S. F. Ravitz, US Dept. of the Interior, Bureau of Mines, report of investigations no. 4900, 1952.
34. W. Langner, A. Göbel, *Erzmetall* 3 (1950) 370.
35. W. Kangro, F. Weingärtner, *Erzmetall* 11 (1958) 70.
36. L. G. Plechanov, *Izv. Akad. Nauk Kaz. SSR Razdel. Metallurgii* 4 (1957) 38.
37. A. Gäumann, *Schweiz. Arch.* 21 (1955) 337.
38. A. A. Sokol, L. F. Kozin, *Ukr. Khim. Zh. Kiev* 25 (1959) no. 2, 249.
39. A. R. Powell, *The Institution of Mining and Metallurgy*, London 1950.
40. Duisburger Kupferhütte, DE 954236, 1954.
41. H. Meister, *Angew. Chem.* 69 (1957) 533.
42. Chem. Werke Hüls, DE 942989, 1954.
43. Licentia Patentverwaltungs-GmbH, DE 1045999, 1957.
44. T. J. Darvojd, V. N. Vigdorovic, N. A. Iordanskaja, *Izv. Akad. Nauk SSSR Otd. Tekh. Nauk Metall. Topl.* 3 (1961) 55.
45. P. R. Mallory & Co., US 2180845, 1939.
46. F. Enßlin, *Erzmetall* 15 (1962) 419.
47. Unterharzer Berg- und Hüttenwerke, DE 740780, 1942.
48. *Chem. Abstr.* 68 (1968) 98239m.
49. A. E. Roach, C. L. Goodzeit, P. A. Totta, *Nature (London)* 172 (1953) 301.
50. A. Hoffman, F. Rose, *Z. Phys.* 136 (1953/54) 152.
51. H. Moser, *Phys. Z.* 37 (1936) 885.
52. S. S. Flaschen, *J. Am. Ceram. Soc.* 42 (1959) 450; 43 (1960) 168, 247.
53. Westinghouse Electric Corp., US 3929970, 1975; 3929976, 1975.
54. Schafer, *Proc. SPIE Int. Soc. Opt. Eng.* 285 (1981) 183.
55. US 4267073, 1981.
56. JP 8199244, 1981.
57. Ethyl Corp., US 3328440, 1967.
58. D. A. Larson et al., *Illum. Eng. (N.Y.)* Preprint no. 29 (1962).
59. W. Brugel: *Physik und Technik der Ultrarotstrahlung*, Vincentz, Hannover 1961.
60. H. R. Schulten, C. Achenbach, U. Bahr, F. Kochler, R. Ziskoven, *Angew. Chem.* 91 (1979) no. 11, 944. C. Achenbach et al., *J. Toxicol. Environ. Health* 6 (1980) 519–528.
61. M. Sager, G. Tolg: "Spurenanalytik des Thalliums", in: *Analytiker-Taschenbuch*, vol. 4, Springer Verlag, Berlin 1984, pp. 443–466.
62. *Am. Ceram. Soc. Bull.* 69 (1990) no. 5, 885.
63. L. Manzo, E. Sabbioni: "Thallium", in H. G. Seiler, H. Sigel, A. Sigel (eds.): *Handbook on Toxicity of Inorganic Compounds*, Marcel Dekker, New York 1988.
64. M. J. Ellenhorn, D. G. Barceloux: *Medical Toxicology, Diagnosis and Treatment of Human Poisoning*, Elsevier, New York 1988.



65. S. Moeschlin: *Klinik und Therapie der Vergiftungen*, 7. ed., Georg Thieme, Stuttgart 1986.
66. H. U. Wolf: "Thallium" in H. U. Wolf (ed.): *HAGERs Handbuch der Pharmazeutischen Praxis*, 5. ed., vol. 3: Gifte, Springer-Verlag, Heidelberg 1992.
67. W. P. Ridley, L. J. Dizikes, J. M. Wood, *Science* 197 (1977) 329.
68. S. Moeschlin, *Clin. Toxicol.* 17 (1980) 133-146.
69. W. Stevens et al., *Int. J. Clin. Pharmacol. Ther. Toxicol.* 10 (1974) 1-22.
70. P. S. Spencer et al., *J. Cell. Biol.* 58 (1973) 79-95.
71. F. H. Lovejoy, *Clin. Toxicol. Rev.* 4 (1982) 1-2.
72. E. Sabbioni, L. Manzo in L. Manzo (ed.): *Advances in Neurotoxicology*, Pergamon Press, Oxford 1980.
73. Berufskrankheitenverordnung, BK Nr. 1106: Erkrankungen durch Thallium oder seine Verbindungen.

## 38 Selenium

BERND E. LANGNER

38.1 Introduction .....	1557	38.6 Environmental Protection .....	1563
38.2 History .....	1557	38.7 Uses .....	1564
38.3 Properties .....	1558	38.8 Quality Specifications and Analysis .....	1566
38.4 Occurrence and Raw Materials .....	1559	38.9 Compounds .....	1566
38.5 Production .....	1560	38.10 Economic Aspects .....	1567
38.5.1 Primary Production .....	1560	38.11 Biological Activity and Toxicology .....	1568
38.5.2 Secondary Production .....	1562	38.12 References .....	1569
38.5.3 Refining .....	1563		

### 38.1 Introduction

Selenium, atomic number 34, is a member of group 16 of the periodic table and thus belongs to the chalcogens. Consonant with its position between the nonmetal sulfur and the metalloid tellurium, it has mainly nonmetallic properties.

Naturally occurring selenium consists of six stable isotopes:  $^{74}\text{Se}$  (0.9%),  $^{76}\text{Se}$  (9.0%),  $^{77}\text{Se}$  (76%),  $^{78}\text{Se}$  (23.5%),  $^{80}\text{Se}$  (49.8%), and  $^{82}\text{Se}$  (9.2%).

### 38.2 History

Selenium is 66th in order of natural abundance in the earth's crust, with an average concentration of 0.05 ppm. Selenium was discovered in 1817 by BERZELIUS in deposits in lead chambers used for the production of sulfuric acid from copper pyrites. The name selenium is derived from  $\sigma\epsilon\lambda\eta\eta\eta$ , the Greek word for moon, and reflects the close resemblance between selenium and tellurium (= earth), which was discovered about 20 years earlier.

Selenium is a by-product of the extraction of metals such as copper, zinc, and lead, and has many industrial applications based on its chemical and physical properties. Its semiconducting properties and the light-induced varia-

tion of its electrical conductivity are of particular importance.

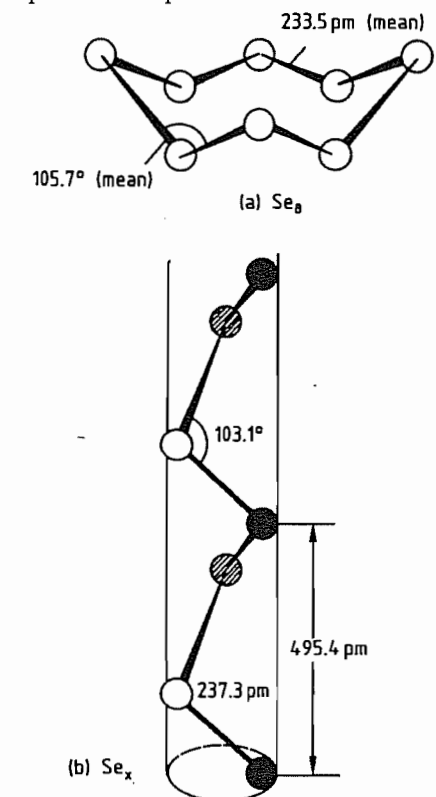

Figure 38.1: Structures of selenium: a)  $\text{Se}_8$  molecule in red  $\alpha$ -,  $\beta$ -, and  $\gamma$ -selenium; b) Helical chains in hexagonal gray selenium [4].

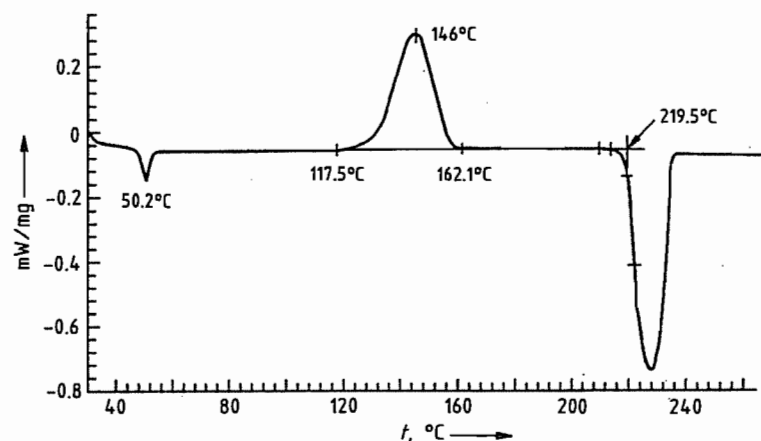

Figure 38.2: Differential thermal analysis of distilled high-purity selenium after 3 h at 450 °C to give a material of uniform structure [8].

### 38.3 Properties [1-4]

Like sulfur, selenium exists in several allotropic forms. The structures of these and the mechanism of transformation of one into another are not completely understood. Red selenium is a thermodynamically unstable, high-energy modification produced by precipitation at low temperature, crystallization of selenium from solution, or quenching of selenium vapor or molten selenium. The three modifications of monoclinic selenium ( $\alpha$ -,  $\beta$ -, and  $\gamma$ -selenium) consist of  $\text{Se}_8$  rings and differ only in the packing of these in the crystal (Figure 38.1). The red, amorphous form consists of chains in an irregular arrangement. It is soluble in carbon disulfide and to some extent in benzene, giving red solutions from which it can be crystallized. Red selenium is an electrical nonconductor. In the vapor phase, selenium exists mainly as  $\text{Se}_8$  rings. At higher temperature these decompose into smaller units, eventually forming  $\text{Se}_2$  molecules.

Thermodynamically unstable vitreous or amorphous forms are obtained by rapid cooling of molten selenium. The structure of these modifications is not yet fully understood. Presumably, high molecular mass selenium rings of various sizes are present, which explains the poorly defined melting point of industrial-grade vitreous selenium. This product softens

at ca. 50 °C to a rubberlike state and is transformed at > 100 °C into the gray, crystalline form, with release of the heat of crystallization. The black, nonconducting form is slightly soluble in carbon disulfide. Structures similar to those in vitreous selenium are present in molten selenium.

On heating to > 100 °C, both the red and the black forms are transformed into the stable, gray, hexagonal ("metallic") form in an exothermic reaction. This modification is also produced by reducing selenous acid with sulfur dioxide at high temperature. Unlike the ring structure of the unstable forms, it consists of helical chains in which the structure is repeated at every third atom (Figure 38.1). Gray selenium is a semiconductor whose electrical conductivity increases by a factor > 1000 under the influence of light (photoconductivity).

Impurities have a great influence on crystallizing properties, so results given in earlier research work, where impurity content is not quoted, are often erroneous. Also, the previous history of the material (e.g., high-temperature treatment) plays an important role in the transformations between various allotropic forms. The thermal properties of selenium can be conveniently investigated by differential thermal analysis [8]. Figure 38.2 shows the various transformations of distilled selenium on melting. The brittle vitreous form is trans-

formed at 50 °C into the ductile vitreous form (glass transition). Above ca. 120 °C, vitreous selenium changes into the stable hexagonal crystalline form, which melts at 220 °C.

Important physical properties of selenium are given below [1, 4]:

Electronic structure	[Ar] 3d <sup>10</sup> 4s <sup>2</sup> 4p <sup>4</sup>
Oxidation states	2-, 0, 4+, 6+
Atomic radius	0.140 nm
Ionic radii	
Se <sup>2-</sup>	0.191 nm <sup>+</sup>
Se <sup>4+</sup>	0.050
Se <sup>6+</sup>	0.042
Ionization energy	940 kJ/mol
Ionization potential	
I	9.75 eV
II	21.5
Electronegativity (Pauling)	2.4
Density at 25 °C	
Hexagonal	4.189 g/cm <sup>3</sup>
$\alpha$ -Monoclinic	4.389
Vitreous	4.285
Liquid (490 K)	3.975
Melting point	217 °C
Boiling point (101.3 kPa; 760 mm Hg)	684.7 ± 0.03 °C
Vapor pressure at 344.6 °C	0.133 kPa (1 mm Hg)
at 431.5 °C	1.333 (10)
at 547.4 °C	13.33 (100)
at 636.5 °C	53.32 (400)
Electrical resistivity <sup>1</sup> at 25 °C	10 <sup>10</sup> $\Omega$ /cm
at 400 °C	1.3 × 10 <sup>5</sup>
Glass transition temperature <sup>2</sup> (vitreous modification)	30.2 °C

The electrical conductivity is strongly dependent on purity. Thus, the conductivity of selenium, including the poorly conducting amorphous form, can be increased considerably by traces (a few parts per million) of halide ions or by alloying elements such as tellurium or arsenic. Because the electrical properties are sensitive to the presence of crystal defects, the purity of selenium, which can be deliberately controlled by doping or alloying with other elements, plays an important role in its use in electrical and electronic applications.

The chemical properties of selenium are intermediate between those of sulfur and those of the metalloid tellurium. In its compounds, it mainly exhibits the oxidation states 2-, 4+, and 6+. The oxidation state 6+ is considerably less stable than for sulfur, and in acid solutions

<sup>1</sup> Strongly dependent on purity and light intensity.

<sup>2</sup> Strongly dependent on purity.

is attained only by the action of strong oxidizing agents such as chlorine or hydrogen peroxide. Selenate(VI) is more easily obtained by oxidation in alkaline solution. The redox potentials of selenium in acid and alkaline solution are as follows [4, 7]:

Acid:

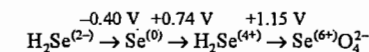

Alkaline:

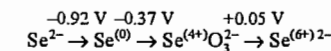

Selenium burns in air to form selenium dioxide, which has the smell of rotten radishes. Selenium is oxidized by nitric acid to selenous acid. No reaction occurs with nonoxidizing acids such as hydrochloric acid. Hot, concentrated sulfuric acid dissolves selenium, giving a green color and forming polymeric selenium cations, for example:

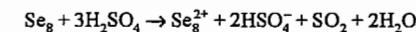

With chlorine, vigorous oxidation to selenium tetrachloride occurs. Selenium reacts with electropositive elements (e.g., many metals) to form selenides and is therefore strongly corrosive, especially at high temperature. With hydrogen, the toxic gas hydrogen selenide is formed. Selenium combines with sulfur to form nonstoichiometric alloys.

Selenium dissolves in solutions of strong alkali, disproportionating into selenide and selenite. It dissolves in alkali-metal sulfides, sulfites, and cyanides, with formation of addition compounds

### 38.4 Occurrence and Raw Materials

Pure selenium minerals are very rare. Thus, berzelianite ( $\text{Cu}_2\text{Se}$ ), tiemannite ( $\text{HgS}$ ), and naumannite ( $\text{Ag}_2\text{Se}$ ) are never processed simply to obtain selenium. However, selenium occurs in various concentrations as an accompanying element in many sulfidic ores, although isomorphic substitution in copper pyrites, iron pyrites, or zinc blende cannot ex-

ceed a theoretical maximum of 0.5% because of the larger ionic radius of selenium ( $\text{Se}^{2-}$ : 0.191 nm,  $\text{S}^{2-}$ : 0.174 nm). The selenium content of pyrites, zinc blende, galena, and molybdenite is too low for economic recovery. However, most copper concentrates from ore flotation contain ca. 100–400 g/t selenium and are hence the most important sources of selenium. Selenium production is therefore closely linked to copper production.

Selenium occurs in low concentrations (ca 15 g/t) in some types of coal and mineral oil.

In addition to extraction of selenium from copper ore, the recycling of photocopying drums and rectifiers is becoming an important source.

## 38.5 Production

### 38.5.1 Primary Production

Selenium is an accompanying element obtained during copper production. The sulfidic copper concentrate (e.g. chalcopyrite) is smelted in an oxidizing atmosphere to give a copper matte containing 40–70% Cu. This is then blown in a converter to yield crude copper. After reduction of excess copper oxide, the crude copper is cast into anodes. Along with other impurities, these copper anodes contain 25–70% of the selenium, depending on the smelting process. The rest of the selenium vaporizes during smelting, mainly as selenium dioxide. This is reduced to the element by the sulfur dioxide produced during smelting and collects in the slime formed in the gas purification equipment.

However, recovery is generally uneconomical due to the complex composition of the slime. Likewise, in the roasting of pyrites and zinc or lead ore, most of the selenium volatilizes and concentrates in the slime in the gas purification equipment. The selenium remaining in the copper anodes is mainly in the form of  $\text{Cu}_2\text{Se}$ , or sometimes  $\text{CuAgSe}$  and  $\text{Ag}_2\text{Se}$ , depending on the silver content. Because they are insoluble in the sulfuric acid electrolyte, these selenides remain in the anode slime dur-

ing electrolytic refining of the copper, as do the noble metals. As a result of the high stability of noble-metal selenides, the copper selenides initially present in the anodes can be converted to silver selenide or gold selenide under the influence of the electrolyte, depending on the noble-metal content. The selenium in the anode slime is therefore in the form of various compounds, depending on the silver content. The selenium content of the anode slime varies with the raw material and can reach > 20%.

Selenium contents (%) of anode slimes (from which residual copper has not been removed) from various copper tankhouses are as follows [9]:

CCR (Noranda), Canada	10.0
Chuquicamata, Chile	4.0
Copper Refineries Pty, Australia	0.7
IMI Refiners, United Kingdom	2.0
Inco, Canada	8.4
Kidd Creek, Canada	19.5
MHO, Belgium	5.1
Norddeutsche Affinerie, Germany	7.5
Palabora, South Africa	3.6
Phelps Dodge, United States	8.8
Southwire, United States	0.6

The precious metals can be recovered only by decomposing the very stable selenides with very strong acid or alkali, or by roasting. Selenium must be removed from the anode slime before the noble metals can be recovered. The important processes are [10]

- Fusion with sodium carbonate
- Roasting with sodium carbonate
- Direct oxidation (roasting)
- Oxidative leaching with sodium hydroxide solution under pressure
- Roasting with concentrated sulfuric acid
- A hydrometallurgical process of chlorination in hydrochloric acid

In roasting with sodium carbonate, the anode slime is first treated with sulfuric acid solution to remove the copper and then mixed with sodium carbonate and water to give a stiff paste. The paste is extruded or pelletized, and dried. It is then roasted at 530–650 °C in a stream of oxygen air. Sodium carbonate prevents vaporization of the selenium as selenium dioxide by converting it completely into so-

dium selenate. The roasted pellets are ground and leached with water to dissolve sodium selenate. The precious metals remain in the solid residue, which also contains tellurium in the form of sodium tellurate if higher roasting temperatures are used. The selenate is crystallized from solution and reduced with active carbon to sodium selenide, which is redissolved in water and oxidized with air to elemental selenium. However, this process leads to the formation of large amounts of wastewater.

Elemental selenium can also be precipitated from selenate solution by strongly acidifying with hydrochloric acid and reducing with iron(II) salts or sulfur dioxide. Alternatively, the sodium carbonate solution can be decomposed by adding acid to precipitate impurities such as tellurium. After filtration and further acidification, selenium is precipitated by reduction (Figure 38.3).

In the direct oxidation process, copper is removed first from the anode slime by sulfuric acid. The slime is then dried and mixed with inert materials that prevent sintering, and the selenium is volatilized as selenium dioxide vapor at 600–900 °C. Silver selenite is formed initially at < 400 °C

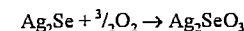

and decomposes at higher temperature

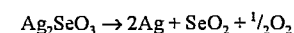

Selenium dioxide and some of the sulfur dioxide formed from the sulfate fraction of the anode slime are removed from the gas phase by scrubbing with water or sodium hydroxide solution. After acidifying the wash liquor, the selenium is reduced with sulfur dioxide (Figure 38.4). Very high volatilization rates are achieved at < 600 °C if the oxidative roasting is carried out in the presence of sulfur dioxide. The reaction is believed to occur via the intermediate formation of sulfur trioxide, which reacts with silver selenite:

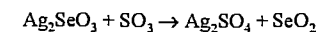

This method is used by Outokumpu [11]. The selenium dioxide produced is absorbed in dilute sulfuric acid and immediately precipitated

as elemental selenium by the excess sulfur dioxide in the scrubbing equipment.

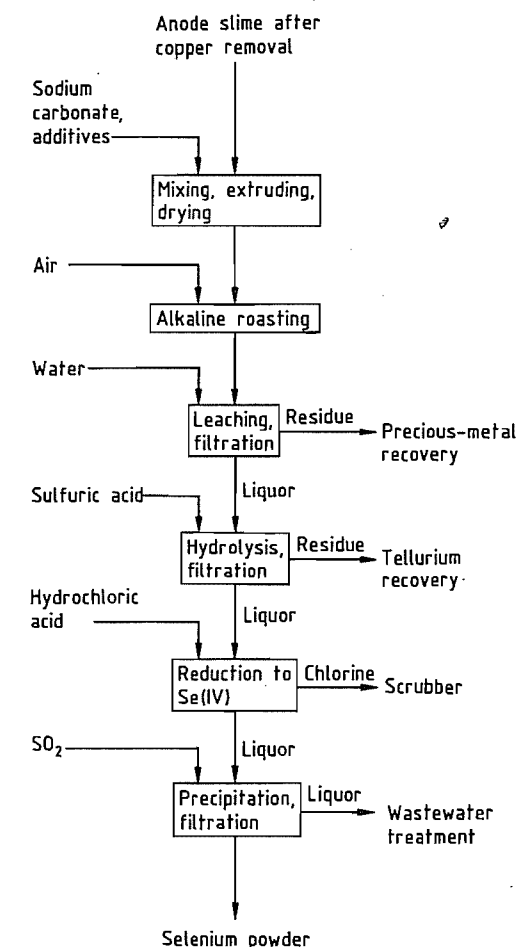

Figure 38.3: Recovery of selenium from copper anode slime by roasting with sodium carbonate.

Whereas roasting is carried out below the melting point of the anode slime, in the classical Doré process (Figure 38.5) the anode slime is melted after addition of fluxes. A matte consisting mainly of silver selenide and a high-lead slag containing precious metals are formed. The slag can be processed in a lead smelting works, or the noble metals can be recovered by flotation. The selenium-containing matte is oxidized in the molten state in a second stage, and selenium is vaporized as its dioxide and absorbed in a scrubbing stage. In a

process operated by the Canadian copper producer Noranda, these two stages are carried out in succession in a top blown rotary converter [12].

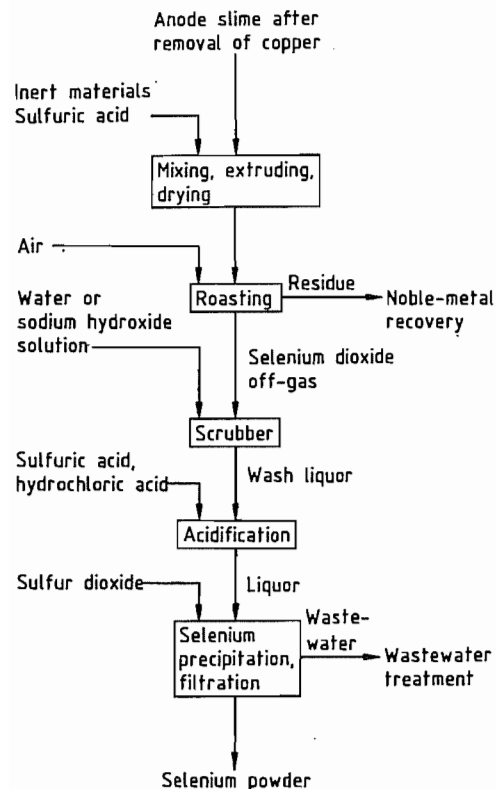

Figure 38.4: Recovery of selenium from copper anode slime by acidic roasting.

Alternatively, roasting with sulfation is carried out in the presence of concentrated sulfuric acid at 500–600 °C after removal of tellurium [9], although the large quantities of sulfur dioxide and sulfur trioxide aerosols formed can present environmental problems, and the severely corrosive properties of sulfuric acid at high temperature are difficult to deal with.

Apart from the widely used high-temperature processes, hydrometallurgical extraction of selenium from copper anode slimes is of some importance in small plants [13–15]. For example, in the copper refinery Austria-Metall [14], the anode slime is leached with hydro-

chloric acid and chlorine, whereby the gold, platinum metals, and selenium (as selenous acid) dissolve, and silver remains in the residue as silver chloride. Selenium is then precipitated from the hydrochloric acid solution by reduction with  $\text{SO}_2$ .

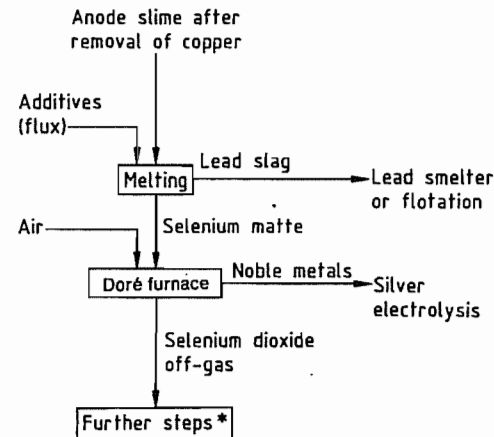
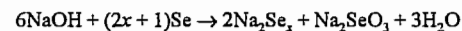

Figure 38.5: Recovery of selenium from copper anode slime by the Doré process. \* See Figure 38.4.

### 38.5.2 Secondary Production

Although most selenium comes from primary production, recycling of the selenium in used rectifiers and photocopying drums is becoming increasingly important for environmental reasons. An older recovery process involves fusion with sodium hydroxide to dissolve the selenium, forming polyselenides:



Selenium is obtained by acidifying the solution, but toxic hydrogen selenide may be formed. This can be prevented if an alkaline solution of sodium sulfite is used in the treatment process. This dissolves selenium selectively, forming sodium selenosulfate:

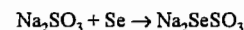

Selenium can be recovered by acidification, which produces  $\text{SO}_2$ .

In another process, selenium is treated with sodium hydroxide solution and hydrogen peroxide to give a mixture of sodium selenite and sodium selenate. The solution is acidified, and

selenium is precipitated by sulfur dioxide [16].

Selenium can also be removed mechanically from photocopying drums by using a water jet. The aluminum drum can be reused whether selenium is removed chemically or mechanically; the selenium on photocopying drums is thus 100% recyclable without any deterioration of its quality. Recycling of photocopying drums is currently performed on a large scale (e.g., by the company Retorte).

Selenium can be dissolved selectively from residues by leaching with ammonia or amines in an aprotic solvent in the presence of carbon monoxide, to form amine salts of selenocarbamic acid. It can then be precipitated in a pure state by heating, with recovery of carbon monoxide and the amine [17].

### 38.5.3 Refining [3]

The roasting processes, followed by precipitation with sulfur dioxide, gives selenium with a purity usually exceeding 99%, which is adequate for many chemical applications. However, for electronic applications or xerography, selenium must be purified further, because of the sensitivity of its physical properties to the presence of impurities.

The simplest method of purification is distillation at atmospheric pressure and ca. 650 °C, which gives a purity up to 99.99%. All the nonvolatile elements, such as copper, nickel, iron, and tellurium (if present as the dioxide), remain in the distillation vessel. However, sulfur and mercury (as  $\text{HgSe}$ ) also distill over and are thus not removed. Therefore, the crude selenium should not contain mercury. A sufficiently pure product is obtained if some of the selenium is not distilled, ca. 50% being left behind in the distillation vessel to be returned later to the recovery process. The corrosive properties of selenium vapor cause problems during distillation, and purified selenium that is collected in cast iron vessels sometimes becomes contaminated with iron. Improved separation is obtained by vacuum distillation at 0.7–1.3 kPa and 360–400 °C, or at 0.1 Pa and 260 °C, which also reduces cor-

rosivity [18]. A further improvement in quality is obtained if the melt is selectively oxidized by atmospheric oxygen before distillation. This gives better separation of the more readily oxidized impurities.

An alternative to distillation for producing high-quality selenium is vaporization with oxidation, the selenium dioxide vapor formed being absorbed in pure water. Mercury can be removed from the solution by adsorption, and the other metallic ions by ion exchangers. Elemental selenium is then precipitated with high-purity sulfur dioxide. Purities > 99.99% can be achieved in this way [19]. After precipitation, the selenium powder is washed and can be remelted if desired (e.g., to produce granules or to homogenize the structure).

High-purity selenium is also obtained by the hydride process. Impure selenium is treated with hydrogen at ca. 550–685 °C to form hydrogen selenide, which is then decomposed at 1000 °C. Alternatively, it can be cooled to remove gaseous impurities before thermal decomposition is carried out [20].

## 38.6 Environmental Protection

Selenium is toxic at high concentration and must therefore be effectively removed from off-gases and wastewater. Since oxidizing processes are used, selenium is present in the off-gas as selenium dioxide. After cooling, it can be removed either by dust filters or, because of its high solubility, by absorption in water or sodium hydroxide solution in gas-scrubbing equipment. Because selenium dioxide is readily reduced by organic compounds or sulfur dioxide, the off-gas always contains a small amount of elemental selenium. The selenium-containing dust filtered out thus generally has a reddish color.

The wastewater treatment process and the minimum attainable selenium content both depend on the form in which selenium is present and on the other components in the wastewater. Although selenites in acid solution are reduced readily to insoluble selenium, complete

removal is often difficult, because the selenium sometimes precipitates as a colloid and the reduction is very slow, especially in dilute solution. Therefore, precipitation aids such as hydroxides of aluminum or iron must be added usually. Adsorptive precipitation then enables a final content of < 10 mg/L Se to be achieved in the wastewater.

Selenium-containing wastewater, as produced in the sour waters from petroleum refining, can be purified by ion exchange [21].

### 38.7 Uses [5, 6]

The uses of selenium and selenium compounds can be divided into the following categories [22]:

Electronic applications	ca. 25%
Pigments	ca. 10%
Glass	ca. 40%
Metallurgy	ca. 10%
Agricultural and biological applications	5%
Other uses (e.g., additives for rubber vulcanization, oxidation catalysts)	ca. 10%

**Rectifiers.** Selenium conducts electricity preferentially in one direction, and this property has been utilized since 1920 for converting alternating to direct current. A selenium rectifier consists of a steel or aluminum plate coated with nickel, with an additional coating of selenium, 50–60  $\mu\text{m}$  thick. A sprayed cadmium alloy is used as a counterelectrode. Several of these rectifiers can be stacked in series. The efficiency of rectification is ca. 85%. Although selenium rectifiers have been increasingly replaced by germanium and silicon diode rectifiers, selenium is still used where the performance of the rectifier must be maintained even in the presence of high counter-voltage peaks.

**Xerography** [23]. The use of selenium in photocopying technology is based on its sensitivity to light. Selenium, which may be highly pure, doped, or alloyed, is deposited by a vaporization process to form a film, ca. 50  $\mu\text{m}$  thick, on an aluminum drum. In the copying process, the selenium surface is first charged by a high-voltage corona discharge. The drum is then exposed to the projected light from the picture. Where the light falls on the drum, the

charge on the selenium flows away, and a latent picture is thereby formed. After the illumination stage, the thermoplastic toner powder is applied to the drum, attracted electrostatically to the charged parts (not illuminated), and then fixed by heat. A photograph of a used photocopier drum after 60 000 photocopying runs is shown in Figure 38.6. The pure, amorphous selenium originally used to coat the drums is very fragile and crystallizes at high temperature. Therefore, selenium stabilized with tellurium or arsenic is now often used (selenium tellurium alloys or arsenic triselenide), generally doped with small amounts of chlorine. The alloys containing high-purity tellurium enable copying rates to be increased and light of a wider spectral range to be used. A still-higher copying rate and wider spectral range are possible with arsenic triselenide, which has been used increasingly in recent years despite its toxicity and problems in manufacture. The drums also have a considerably longer life. The selenium-based system is now being replaced by organic photoconductors and amorphous silicon in low-cost applications. However, selenium is maintaining its position in industrial applications because of its long life and high photocopying capacity. Whereas a drum with organic photoconductors has a lifetime of ca. 10 000–30 000 copies, drums coated with selenium can withstand more than 100 000 copying operations.

A potential application of xerography with selenium as the photoconductor is in medicine. Here, X rays are used instead of visible light to form the latent image. The advantage of this process lies in the possibility for direct digitization without producing a copy or a film, so that the X-ray image is generated directly by a computer on a visual display unit, and can be stored and processed. Although several patents exist and comprehensive research has been carried out, the process is not yet in general use [24, 25].

**Glass Manufacture.** Selenium and selenium compounds are used in silicate glass both in decolorization and as a colorant for producing

intense yellow to red glass for special applications (selenium pink glass).

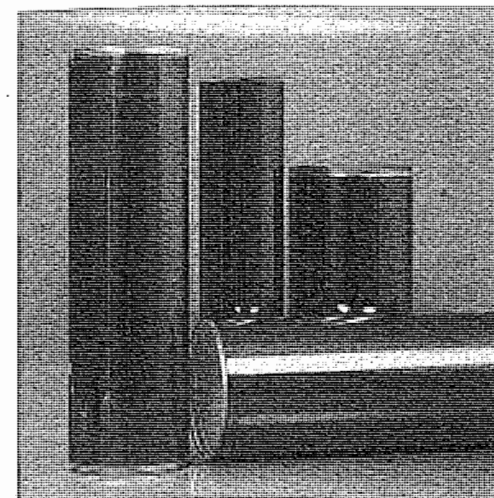

Figure 38.6: Selenium-coated photocopier drum after 60 000 copies.

The main application in glass manufacture is in the decolorization of glass, which is always colored green to yellow green by traces of iron(II) and iron(III). The addition of 30–150 g/t selenium compensates for this color by adding the pink of the selenium, with no apparent reduction in transparency [26]. Formerly, selenium was added mainly as the element. However, elemental selenium volatilizes below the melting temperature of glass, so the yields were usually < 50%. Therefore, selenium compounds such as sodium selenite, sodium selenate, barium selenite, or zinc selenite are now increasingly used. Even so, some volatilization losses are unavoidable. If an excess of selenium is used, pink glasses are obtained that used to be important for artistic purposes.

The addition of cadmium sulfoselenide to glass gives intense colors such as those required for signal technology (e.g., traffic lights). The colors vary from yellow to red, depending on the CdSe content and melting conditions. Because of the volatility of selenium compounds, reproducible color control is difficult.

**Pigments.** Selenium is used as a pigment in the form of cadmium sulfoselenide. Replacement of part of the sulfur in cadmium sulfide by selenium changes the yellow color to an intense red. The pigment has good brightness and high stability. It is an important colorant for plastics, because the addition of up to 1.5% cadmium sulfoselenide does not significantly affect their physical properties; it is also stable at the temperatures used for injection molding and extrusion. However, the importance of these pigments has declined considerably because of the toxicity of cadmium compounds. In some areas, the use of cadmium sulfoselenide is prohibited.

**Metallurgy.** The addition of selenium to steel improves its machinability, resulting in higher cutting speeds, lower energy consumption, and a longer lifetime for the machine tool. Although this is often achieved by adding sulfur, selenium is always used where good hot and cold formability, corrosion resistance, and surface finish are also required. For stainless steel, the addition rate is ca. 0.1–0.3% Se. The machinability of copper can also be improved by addition of selenium, but tellurium is used more often. Addition of up to 0.1% selenium to magnetic silicon steels improves their magnetic properties for use in transformer cores. Selenium is also used in lead accumulators to improve the casting and mechanical properties of lead antimony alloys with low antimony content.

Ferroselenium, copper selenide, and nickel selenide are used in metallurgy.

**Agriculture.** Although the toxicity of soil with high selenium content has long been known, only much later was the need for selenium as an essential trace element in low concentrations discovered. A number of diseases formerly thought to be due to vitamin E deficiency are in fact the result of a deficiency of selenium. For example, the addition of 0.1–0.3 ppm selenium to the feed of chickens and pigs considerably increases their growth rate and prevents certain diseases, although the mechanism of this is not fully understood. Selenium may act as an antioxidant or free-radical trap.

The high rate of heart disease in Finland is thought to be due to a selenium deficiency, the soil being low in selenium, and the law now requires that 6–16 g/t selenium be added to fertilizers used there.

Selenium is added to fertilizers or animal feed in the form of sodium selenite or sodium selenate, which are absorbed more readily by plants.

**Other Uses.** Selenium and selenium compounds (e.g., Selenac, dialkylselenium carbamates) are added with sulfur in rubber manufacture. This improves the thermal stability of the product and controls the vulcanization rate.

Selenium compounds are used to a small extent as additives to oxidation catalysts for hydrocarbons. Selenium dioxide is also used as a selective oxidizing agent in organic chemistry.

Selenium acts as an absorbent for mercury, forming stable mercury selenide, in gas purification [27].

Addition of up to 5% selenium has been proposed in the preparation of dental amalgams [28].

## 38.8 Quality Specifications and Analysis

Standard-grade selenium containing 99.5% Se is adequate for chemical and metallurgical use, although many producers supply a 99.9% Se material. A special pigment grade containing 99.8% Se is also marketed. The standard grades are supplied as powders of various bulk densities, depending on precipitation conditions. The standard grade is used mainly as starting material for the production of high-purity selenium for photocopiers and electronic applications, which require a product containing > 99.999% Se. Here, the heavy-metal content must also be as low as possible, and the oxygen content should be much less than 5 ppm. Electronic-grade selenium is supplied in the form of granules, which can be produced by pouring molten selenium into deionized water. In addition to chemical anal-

ysis, the quality assessment of high-purity selenium includes measurement of electrical and especially the photoelectrical properties [29]. The crystallization temperature, determined by thermal analysis, can give a useful indication of the impurities in selenium (Figure 38.2), although interpretation of the results is not always unambiguous.

The methods of analysis for selenium depend on the matrix material. Direct spectroscopic determination in raw materials and intermediate products is usually impossible due to lack of standards. Hence, selenium-containing materials are first treated with nitric or sulfuric acid, for example, to dissolve the selenium as selenous acid. Most methods of determination involve reduction of selenous acid with various reducing agents, usually in solution in strong hydrochloric acid. Selenium can be determined gravimetrically after reduction with iron(II), for example, if the hydrochloric acid concentration is such that precipitation is complete and no loss of  $\text{SeCl}_4$  vapor occurs [30]. The precipitated selenium is weighed, or redissolved and determined by atomic absorption spectroscopy, inductively coupled plasma, or direct coupled plasma spectroscopy [31]. In one of the oldest methods still in use, selenous acid is titrated with thiosulfate according to the equation:

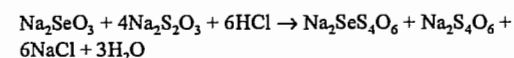

Sodium monoselenopentathionate is formed, and the excess of thiosulfate is back-titrated iodometrically [32].

## 38.9 Compounds

Selenium forms a large number of chemical compounds, some of which are of major industrial importance.

**Selenium Dioxide, Selenous Acid, Selenites.** Volatile selenium dioxide (sublimes at 315 °C) is formed by the combustion of selenium-containing materials. Selenium dioxide dissolves readily in water (800 g/L at 85 °C) to form selenous acid. Unlike sulfur dioxide selenium dioxide and selenous acid are easily re-

duced to selenium by reducing agents such as sulfur dioxide. Even traces of organic material reduce part of the selenium dioxide to selenium, resulting in a slightly reddish color of the  $\text{SeO}_2$ . The sensitivity to reduction is increased by the influence of light. Selenium dioxide is used to oxidize alkyl groups to carbonyl groups in organic chemistry, as a lubricant additive, and as an additive in the electrolysis of manganese. Selenous acid is more stable than sulfurous acid and can be isolated in the pure state in the form of colorless prisms. Selenous acid decomposes above 70 °C, forming selenium dioxide and water. Sodium selenite, zinc selenite, and barium selenite are important additives in glass manufacture. These salts are prepared by the reaction of selenous acid with the corresponding hydroxides or oxides, followed by crystallization.

**Selenium Trioxide, Selenic Acid, Selenates.** Selenous acid is oxidized to selenic acid by strong oxidizing agents such as chlorine, chloric acid, ozone, or anodic oxidation. Selenic acid is a hygroscopic solid that melts at 59.9 °C. It is a much stronger oxidizing agent than sulfuric acid; for example, a mixture of concentrated selenic acid with concentrated hydrochloric acid evolves chlorine. Selenic acid can be dehydrated with phosphorus pentoxide or by applying vacuum (200 Pa) at 160 °C to give the strongly oxidizing selenium trioxide (*mp* 118 °C). Above 185 °C, selenium trioxide decomposes into selenium dioxide and oxygen. Selenates are formed by the reaction of selenic acid with metal oxides or hydroxides, and resemble the isomorphous sulfates in both structure and solubility. Sodium selenate has recently become an important fertilizer additive.

**Hydrogen Selenide, Selenides.** Hydrogen selenide can be obtained either directly from the elements at ca. 400 °C or by decomposition of the selenides of iron, magnesium, or aluminum with hydrochloric acid. It is a colorless gas (*bp* -41.3 °C) smelling like rotten radishes, is even more toxic than hydrogen sulfide, and has a very irritating effect on the

mucous membranes, causing bronchial and nasal irritation. Hydrogen selenide is less stable than hydrogen sulfide and can be oxidized to selenium by air, especially in the presence of light. Heavy-metal selenides such as copper selenide form the basis of selenium extraction from ores. Cadmium selenide, produced from cadmium and selenium, is used in the pigment industry together with cadmium sulfide.

High-purity zinc selenide is an important infrared optical material. Single crystals can be produced by reacting zinc vapor with hydrogen selenide (chemical vapor deposition, CVD). Copper indium selenide could be the basis for solar cells of the future; light efficiencies of 14% at an energy flux density of > 100 W/m<sup>2</sup> can be achieved. However, the manufacturing process (CVD) is expensive [23, 33].

**Selenium disulfide** is formed by reaction of hydrogen sulfide with selenous acid or by direct combination of the elements. The red powder (*mp* ca. 100 °C) is used in concentrations of < 1% in shampoos and hair preparations for the treatment of dandruff.

**Selenium Halides.** The action of halogens or halides on elemental selenium yields various selenium halides, depending on the temperature and stoichiometric ratio. Selenium monochloride,  $\text{Se}_2\text{Cl}_2$  ( $\rho$  2.774 g/cm<sup>3</sup>), and selenium monobromide,  $\text{Se}_2\text{Br}_2$  ( $\rho$  3.604 g/cm<sup>3</sup>), are intensely colored, heavy liquids.  $\text{SeCl}_4$  and  $\text{SeBr}_4$  are crystalline substances that readily form complexes with alkali-metal halides. Selenium exhibits the oxidation state 6+ only in  $\text{SeF}_6$ , the corresponding chloride and bromide being unstable. Of the oxyhalides, selenyl chloride,  $\text{SeOCl}_2$ , is liquid at room temperature and is remarkable for its extreme reactivity, combining with almost all elements.

## 38.10 Economic Aspects

The total consumption of selenium in 1989/1991 was ca. 2100–2300 t/a (Table 38.1) [22, 34]. Average consumption in previous years was ca. 1700 t/a, although the published figures are unreliable due to the lack of informa-

tion from Eastern European countries. Of the total, about one-third is produced as high-purity selenium for electronic applications. Since selenium is a by-product of copper production, its price is subject to very wide variations due to over- or underproduction from time to time. In recent years, the price of selenium has decreased considerably (Table 38.1). However, most dealing takes place not on the open market, but directly between the producer and consumer, so the true prices differ from the published prices. The price for standard-grade selenium in 1990 was ca. \$10/kg, and for high-purity selenium ca. \$30–50/kg [22]. Manufacturers of elemental selenium in the Western world include the large copper producers Noranda Mines (Canada); Norddeutsche Affinerie AG (Germany), with its subsidiary Retorte producing selenium compounds and high-purity selenium; Metallurgie Hoboken-Overpelt (Belgium); Mitsubishi Metals, Nippon Mining, Sumitomo (Japan); Outokumpu (Finland); ASARCO, Kennecott, and Phelps Dodge (United States) [35]. Selenium compounds are also produced by Degussa (Germany).

Although the consumption of selenium compounds in the glass industry and as a fertilizer additive is increasing, the use of cadmium selenide in pigments is decreasing, and selenium is being replaced by organic photoconductors in some types of xerography. Therefore the total consumption of selenium is not expected to increase in the near future. However, the supply of selenium could decrease in the future if copper is produced partly by hydrometallurgical processes, which do not yield a selenium by-product.

### 38.11 Biological Activity and Toxicology

Although selenium is an important trace element in low concentrations, it is toxic at higher concentrations. It is an essential trace element in the selenoenzyme glutathione peroxidase. This enzyme, together with vitamin E, is important for the protection of cells from

oxidative attack. The activity of glutathione peroxidase in red blood corpuscles correlates well with the selenium concentration up to 100 µg/L [36, 37]. Low selenium levels in the blood cause heart disease. For instance, in China, Keshan disease, a cardiomyopathy, caused the deaths of a large number of people, especially children, until the daily consumption of selenium was found to be very low. The transition from essential trace quantities to toxic quantities of selenium in terms of intake in food is summarized below [37]:

Low-selenium area with Keshan disease	11 µg/d
Selenium adequate area	116 µg/d
National Academy of Sciences, Food and Nutrition Board "safe and adequate" range	50–200 µg/d
Lowest observed effect level (LOEL)	3200 µg/d
High-selenium area with chronic selenosis	4990 µg/d

**Table 38.1:** Estimated production (t), consumption (t), and price (\$/kg) of selenium [22, 35].

	1989	1990	1991
<b>Production</b>			
Belgium	275	360	260
Canada	270	340	240
Chile	40	40	40
Finland	10	25	25
Germany	110	110	100
Japan	534	550	631
South Korea	20	25	25
Mexico	25	25	25
Peru	20	20	20
Philippines	120	120	120
Sweden	60	30	30
United States	253	287	240
Yugoslavia	50	60	40
Zambia	50	60	40
Others	100	100	100
<b>Total</b>	<b>1937</b>	<b>2052</b>	<b>1918</b>
<b>Consumption</b>			
United States	560	530	500
Japan	283	289	263
Europe	830	800	770
China	200	300	350
Others	300	300	300
<b>Total</b>	<b>2173</b>	<b>2119</b>	<b>2283</b>
<b>Average price</b>	<b>13.81</b>	<b>11.26</b>	<b>10.56</b>

The concentration of selenium in the blood should be 60–100 µg/L. Although small amounts of selenium may reduce the risk of cancer, as indicated by some investigative studies, this has not been proved conclusively.

A chronic high selenium intake of > 5 mg/d gives rise to nonspecific symptoms such as

hair loss, changes to the fingernails, diarrhea, effects on the central nervous system, and nonspecific changes to the liver. Also, a loss of appetite and a tendency to walk in a circle can occur. High concentrations of selenium in the workplace can cause headaches and "selenium catarrh". Also, the breath can have a garliclike smell due to the formation of methyl selenide, although this effect is much less pronounced than with tellurium.

A few selenium compounds exhibit acute toxicity. Irritation of the mucous membranes of the digestive system, liver damage, and toxic edema of the lungs have been observed. The most toxic compound is hydrogen selenide, for which the MAK is 0.05 ppm, the MAK value for other selenium compounds being 0.1 ppm. In the United States, the TLV is 0.2 mg/m<sup>3</sup>. In a study carried out in Canada on people working in selenium production, if the TLV was exceeded slightly (up to 0.8 mg/m<sup>3</sup>) for limited periods, no symptoms resulted [38]. In Germany, the limit in drinking water is 0.008 mg/L [39], and in the United States, the EPA recommends a maximum contamination level (MCL) of 0.01 mg/L.

### 38.12 References

- R. A. Zingaro, W. C. Cooper: *Selenium*, Van Nostrand Reinhold, New York 1975.
- K. W. Bagnall: *The Chemistry of Selenium, Tellurium and Polonium*, Elsevier, Amsterdam 1966.
- Gmelin, System no. 10, Teil A 1953, Teil B 1949, Ergänzungsbände 1979, 1980, 1981, 1984.
- N. N. Greenwood, A. Earnshaw: *Chemie der Elemente*, VCH Verlagsgesellschaft, Weinheim 1988.
- S. C. Caparella (ed.), *Proc. Int. Symp. Ind. Uses Selenium Tellurium 3rd* (1984).
- S. C. Caparella (ed.), *Proc. Int. Symp. Uses Selenium Tellurium 4th* (1989).
- A. J. Bard (ed.): *Encyclopedia of Electrochemistry of the Elements*, Dekker, New York 1975.
- M. Nachtrab, Retorte Company, personal communication.
- W. C. Cooper, *J. Met.* **42** (1990) Aug., 45.
- J. E. Hoffmann, *J. Met.* **41** (1989) July, 33.
- O. Hyvarinen, L. Lindroos, E. Yllö, *J. Met.* **41** (1989), July, 42.
- Noranda Minerals, US 4581064, 1986 (B. H. Morrison, J. G. Lenz, J. Pageau, J. G. Bard).
- H. Bußmann, K. F. Dobner, *Erzmetall* **43** (1990) 362.
- Austria Metall, FP 0263910, 1986 (J. Bertha, J. Wallner, H. Wörz).
- J. E. Hoffmann, *J. Met.* **42** (1990) Aug., 50.
- L. A. Teixeira, R. E. Reber, L. Y. Tavares: "The Mineral, Metals & Materials Society", *EPD Congress 90*, Warrendale 1990, p. 209.
- N. Sonoda, N. Hosoda, K. Hori, US 4663141, 1985.
- F. Eckardt, H. Berg, *Naturwissenschaften* **45** (1958) 335–336.
- Nippon Mining, JP 3108, 1956 (N. Imai, M. Endo); *Chem. Abstr.* (1957) 10858.
- Bayer, DE-OS 1170912, 1962 (H. Giesekus, H. Schöning).
- P. J. Marcantonio, US 4915928, 1990.
- Gardener, *Met. Miner. Rev.* (1991) 91.
- M. Caffaray, *Trans. Inst. Min. Metall. Sect. C* **97** (1988) C87.
- Siemens, DE-OS 3236137, 1984 (K. Kempter).
- U. Schiebel, T. Buchkremer, G. Frings, P. Quadflieg, *J. Non Cryst. Solids* **115** (1989) 216.
- B. Simmingsköld in [5], p. 274.
- K. Itagaki, A. Yazawa, *Erzmetall* **35** (1982) 358.
- A. Sato, US 4528034, 1982.
- M. Benson, H. J. Davis in [6], p. 241.
- A. M. Seherhaufer, *Fresenius Z. Anal. Chem.* **164** (1958) 327.
- M. Verlinden, H. Delestra, E. Adriënsens, *Talanta* **28** (1981) 637.
- J. F. Norris, H. Fay, *Am. Chem. J.* **20** (1898) 278.
- K. Mitchell, C. Eberspacher, K. Pauls in [6], p. 572.
- Metall Bulletin* (1990) 15th March, p. 15.
- D. Edelstein in [6], p. 7.
- M. Piscator in [6], p. 88.
- R. A. Goyer in [6], p. 97.
- J. P. Robin in [6], p. 103.
- Bundesgesetzblatt, "Trinkwasserverordnung", Part I, no. 16, 1975, p. 453.

# 39 Tellurium

GUY KNOCKAERT

39.1 Introduction .....	1571	39.7 Analysis .....	1576
39.2 History .....	1571	39.8 Compounds .....	1576
39.3 Properties .....	1571	39.9 Uses .....	1577
39.4 Resources and Raw Materials .....	1572	39.10 Economic Aspects .....	1579
39.5 Production .....	1573	39.11 Toxicology and Occupational Health .....	1579
39.6 Quality Specifications .....	1576	39.12 References .....	1580

## 39.1 Introduction

Tellurium, atomic number 52, is a metallic element of group 16 in the periodic table.

Tellurium has 8 natural stable isotopes, and is known to have a total of 21 artificial unstable isotopes. The natural abundance of the stable isotopes is:  $^{120}\text{Te}$  (0.096%),  $^{122}\text{Te}$  (2.60%),  $^{123}\text{Te}$  (0.908%),  $^{124}\text{Te}$  (4.816%),  $^{125}\text{Te}$  (7.14%),  $^{126}\text{Te}$  (18.95%),  $^{128}\text{Te}$  (31.69%), and  $^{130}\text{Te}$  (33.80%) [1]. The abundance of tellurium in the Earth's crust is comparable to that of platinum, 0.01 ppm.

## 39.2 History

Tellurium was discovered in 1782 by MÜLLER VON REICHENSTEIN and named by KLA-PROTH in 1798 (Latin, *tellus*, Earth) [2].

## 39.3 Properties [1, 3–12]

Tellurium is a crystalline, bright silver-white metal, which is rather brittle and easily crushed. Tellurium is relatively soft (2.3 Moh, nearly as hard as zinc).

The crystal structure is a three-point helical lattice with hexagonal symmetry, with the helical chains parallel to the hexagonal axis. Many physical and electrical properties, e.g., hardness, thermal expansion coefficient, Hall coefficient, resistivity, and diamagnetic susceptibility are anisotropic. The so-called

amorphous phase actually contains very small hexagonal crystals.

Tellurium, a *p*-type semiconductor, demonstrates the phenomenon of piezoelectricity and becomes superconductive at 3.3 K. Some tellurium compounds have excellent thermoelectric properties which are commercially interesting. Trace additives of tellurium to steel, lead, and copper and their alloys have a positive influence on the machinability of tools.

Tellurium has a relatively low melting (723 K) and boiling point (1327 K). On melting, the specific volume increases by ca. 5%. Tellurium vapor is yellow-gold and consists mainly of  $\text{Te}_2$  molecules up to 2000 °C. Some physical properties of tellurium are:

Electronic configuration	[Kr] $4d^{10} 5s^2 p^4$
Thermal neutron cross section at 2200 m/s	
absorption	$(4.7 \pm 0.1) \times 10^{-28} \text{ m}^2/\text{atom}$
scattering	$(5 \pm 0.1) \times 10^{-28}$
Crystal structure	hexagonal lattice with trigonal symmetry (A8)
	$a_0 = 0.4457 \text{ nm}$
	$c_0 = 0.5929 \text{ nm}$
	bond angle $(103.2 \pm 0.1)^\circ$
	0.1285 nm
Atomic radius	
Ionic radius	
$\text{Te}^{4+}$	0.089 nm
$\text{Te}^{2-}$	0.221 nm
Atomic volume	$20.42 \times 10^{-6} \text{ m}^3/\text{mol}$
Density at 300 K	$6.245 \text{ g/cm}^3$
<i>mp</i>	722.6 K
<i>bp</i>	1327 K
Enthalpy of fusion	17.489 kJ/mol
Enthalpy of vaporization ( $\text{Te}_2$ )	107.77 kJ/mol
Specific heat at 25 °C	$25.707 \text{ Jmol}^{-1}\text{K}^{-1}$
Entropy at 25 °C	$49.497 \text{ Jmol}^{-1}\text{K}^{-1}$
Entropy of fusion	$24.201 \text{ Jmol}^{-1}\text{K}^{-1}$



Entropy of vaporization	36.6 Jmol <sup>-1</sup> K <sup>-1</sup>
Coefficient of linear expansion, mean value (anisotropic)	16.8 × 10 <sup>-6</sup> K <sup>-1</sup>
Vapour pressure <i>p</i> at 793 K	0.133 kPa
at 923 K	1.33
at 1111 K	13.3
Thermal conductivity at 293 K	0.060 Wm <sup>-1</sup> K <sup>-1</sup>
Surface tension at temperature <i>T</i> , <i>T<sub>mp</sub></i> = melting point	0.178 – 2.4 × 10 <sup>-5</sup> ( <i>T</i> – <i>T<sub>mp</sub></i> ) N/m
Electrical resistivity at 3.3 K	superconducting
at 300 K	9.9 × 10 <sup>-3</sup> Ωm
Standard electrode potentials	
Te + 2e <sup>-</sup> → Te <sup>2-</sup>	-0.92 V
Te <sup>4+</sup> + 4e <sup>-</sup> → Te	0.63
Tensile strength	11.0 ± 0.25 MPa
Modulus of elasticity	4140 MPa

Metallic tellurium has many properties similar to sulfur and selenium, but it is less reactive, more basic, more metallic, and strongly develops amphoteric properties. When metallic tellurium is heated in air, it burns with a blue-green flame; tellurium powder oxidizes at room temperature.

Tellurium reacts vigorously with halogens at room temperature, cannot be combined directly with sulfur, and reacts with hydrogen at high temperature (920 K). Tellurium does not react with carbon, boron, or nitrogen; it reacts with phosphorus only in a sealed tube heated above 595 K.

Tellurium is insoluble in water, dissolves in concentrated sulfuric and nitric acid, and only slightly in dilute hydrochloric acid. The solubility in caustic alkalis depends on the temperature; tellurium is, however, insoluble in ammonium hydroxide.

When heated in an evacuated ampule, stoichiometric amounts of tellurium and one or more other elements form binary or ternary tellurides. Molten tellurium corrodes iron, copper, and stainless steel.

### 39.4 Resources and Raw Materials [13]

Tellurium, a relatively rare element with a crustal abundance of 10 µg/kg, is found in close association with sulfur as well as with selenium. Unlike the latter, tellurium does not substitute in sulfide lattices, but forms discrete minerals or microsegregations in the host sulfide mineral [14].

Native tellurium has been observed, but the element is mainly found as a gold and/or silver telluride. The concentration of tellurium minerals in nature is insufficient to allow their economic recovery as principal mining products; its recovery therefore depends on its concentration during the processing of other nonferrous metals. In copper refining, tellurium accumulates together with precious metals and selenium in the anodic slimes generated by electrolysis. Other primary metals such as zinc, gold, and lead, concentrate tellurium during refining.

Reserves of tellurium are difficult to assess because of the limited knowledge of tellurium content in the copper or other ores from which it is recovered. Estimations of refinery production of tellurium are complicated by the trade in concentrates, blister, and anode copper, as well as other nonferrous residues.

As copper ores are the main sources for tellurium, public statistics are based on the copper industry. The United States Bureau of Mines estimates tellurium resources by applying fixed recovery factors (i.e., 0.065 kg Te per tonne of Cu) and quotes the figures in tonnes [15].

Continent, country	Tellurium reserves, t
North America	
United States	6 000
Canada	2 000
Others	3 000
South America	
Chile	6 000
Peru	2 000
Others	1 000
Europe	5 000
Africa	
Zaire	2 000
Zambia	2 000
Others	1 000
Asia	
Philippines	1 000
Others	1 000
Oceania	2 000
World	34 000

The results of these estimations do not include tellurium resources included in lead, zinc, or gold reserves.

### 39.5 Production [16–22]

Tellurium can be recovered as a by-product in the treatment of lead, copper, bismuth, precious metals, and nickel ores, and from sulfuric acid plants. The main source is copper anode slimes, which settle at the bottom of the refining tanks during the electro-winning of 99.9% pure copper. Copper anode slimes contain 0.5–10% tellurium (Table 39.1).

Table 39.1: Composition of copper anode slimes: selected examples [23–25].

Element	Typical concentration, %		
	Canadian Copper Refiners	Nippon Mining	Inco
Cu	20.3	4.73	17
Bi	0.36	1.6	0.1
Sb	0.95	0.95	0.05
Se	10.9	15.23	7
Te	3.19	3.64	2
Pb	8.5	6.54	1
Au		0.99	0.1
Ag	21.3	20.58	6
As	1.83	1.59	0.8
Ni	0.52	0.03	26

Tellurium is collected with the precious metals in the anode slimes, and has to be separated from these together with selenium, because they interfere with the separation and refining of the precious metals. Tellurium is mostly present in the form of intermetallic compounds of silver, copper, and sometimes gold [Ag<sub>2</sub>Te, Cu<sub>2</sub>Te, and (Ag, Au)Te<sub>2</sub>]. Pretreatment of the slimes can dissolve the copper which is harmful in the further treatment of the slimes. It is normally followed by roasting or sulfatizing of the decopperized slimes, or a combination of these and alternative methods.

**Pretreatment** consists of dissolving residual copper and tellurium by dilute aerated sulfuric acid or by oxidative pressure leaching with dilute sulfuric acid (normally tankhouse liquid from the copper electrolysis). The first method dissolves 70–80%, the second > 90% of the tellurium. Pressure leaching takes place in an autoclave under an oxygen pressure of 250–350 kPa at 80–160 °C. Depending on the conditions, tellurium is converted to the tetravalent or hexavalent form. Tests have been performed at oxygen pressure up to 1000 kPa

whereby copper and tellurium are completely dissolved, together with part of the contained silver and selenium, which, after contact with a reducing agent (e.g., SO<sub>2</sub>) at atmospheric pressure, reprecipitate [23]. The dissolved tellurium in the filtrate is consequently recovered as copper telluride (Cu<sub>2</sub>Te) by cementation with copper above 80 °C. This can be performed in a rotating drum containing copper shot or in a fixed-bed reactor filled with copper chippings [26]. Other techniques use copper electrodes suspended in a bath containing the dissolved copper and tellurium sulfate, agitated by vibration or alternating current to the electrode to remove the deposited copper telluride [27, 28]. Figure 39.1 illustrates a possible pretreatment scheme.

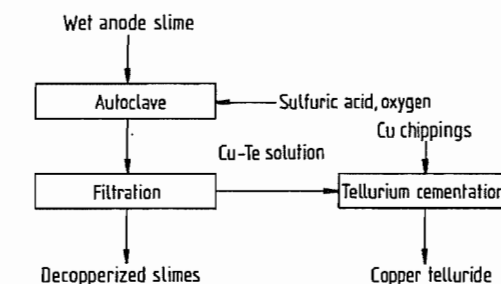
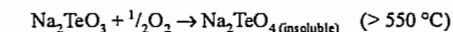
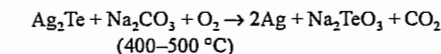
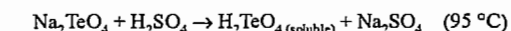

Figure 39.1: Anode slime pretreatment scheme.

**Roasting.** Pretreated decopperized slimes are roasted with soda ash, whereby tellurium is converted to insoluble sodium tellurite and tellurate:



Normally, complete conversion to hexavalent tellurium is preferred with roasting temperature 550–650 °C. Other processes operate below 400 °C or up to 750 °C, involving different process steps. After water leaching, selenium is recovered as soluble sodium selenate. The residue containing tellurium (as sodium tellurate), lead, and precious metals is either sent to a doré furnace, or treated with sulfuric acid:



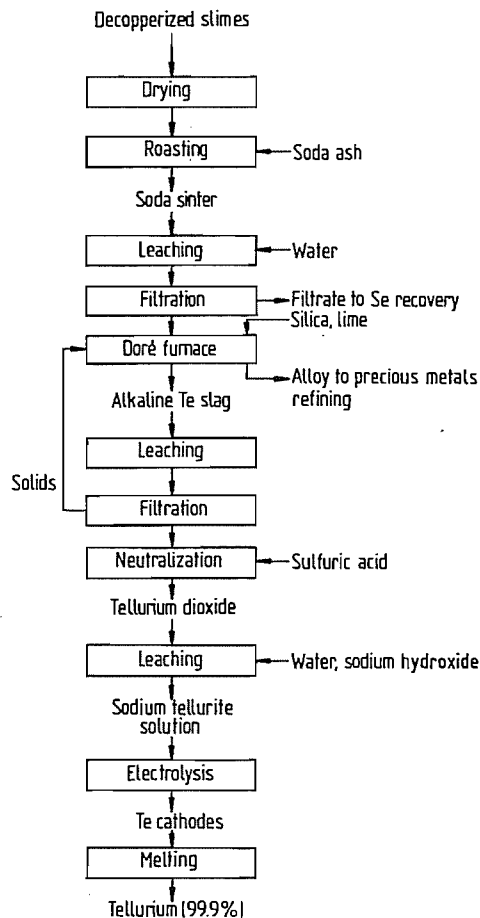
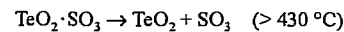
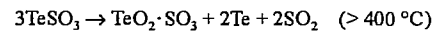
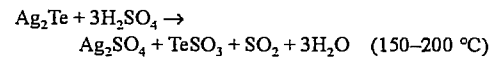

Figure 39.2: Soda ash roasting and doré furnace treatment.

In this processing step, the residue containing lead and precious metals is separated for further treatment. The telluric acid is reduced to tellurium by treatment with hydrochloric acid and sulfur dioxide, or reduced by sodium sulfite to tellurium dioxide, or precipitated as copper telluride by adding copper. If there is no preliminary sulfuric acid treatment, the residue still containing the sodium tellurate is smelted in a doré furnace, where the tellurium is collected in a soda slag leached with water to convert it to sodium tellurite. It is then neutralized with sulfuric acid to tellurium dioxide. Copper telluride and tellurium dioxide can be

leached with dilute sodium hydroxide (with aeration in the case of copper telluride) to form a sodium tellurite solution which is further prepared for electrolysis. Figure 39.2 shows a soda ash roasting process combined with a doré furnace.

**Sulfation** takes place in two stages: below 350 °C the sulfuric acid forms metal sulfates with the proper consistency to be roasted above 400 °C in the second stage. In this stage, selenium dioxide is eliminated. For tellurium, the following reactions take place:



The tellurium dioxide remains in the sulfated slimes, which are leached with water. Part of the tellurium is dissolved, and can be cemented with copper to yield copper telluride. The leach residue can be treated in the doré furnace. Alkaline leaching of the residues yields soluble sodium tellurite, but this process does not recover all the tellurium. Figure 39.3 shows a sulfating roasting process for the recovery of tellurium.

**Other Techniques.** The oxidation of slimes under pressure in alkaline solution can be used to give good separation of tetravalent selenium and hexavalent tellurium after oxidation. Sodium hydroxide concentration is 100–500 g/L, the temperature is ca. 200 °C, and the oxygen partial pressure is 170–1700 kPa. Pressure leaching with oxygen or hydrogen peroxide is also possible [29, 30]. Aqueous or dry high-temperature chlorination of slimes has been developed. Dry chlorination being difficult to control, wet chlorination is preferred. The slimes are sparged with chlorine gas or sodium chlorate at ca. 100 °C, and all selenium and tellurium is recovered in the soluble form.

The recovery of tellurium from secondary materials accounts for 10–20% of world tellurium production.

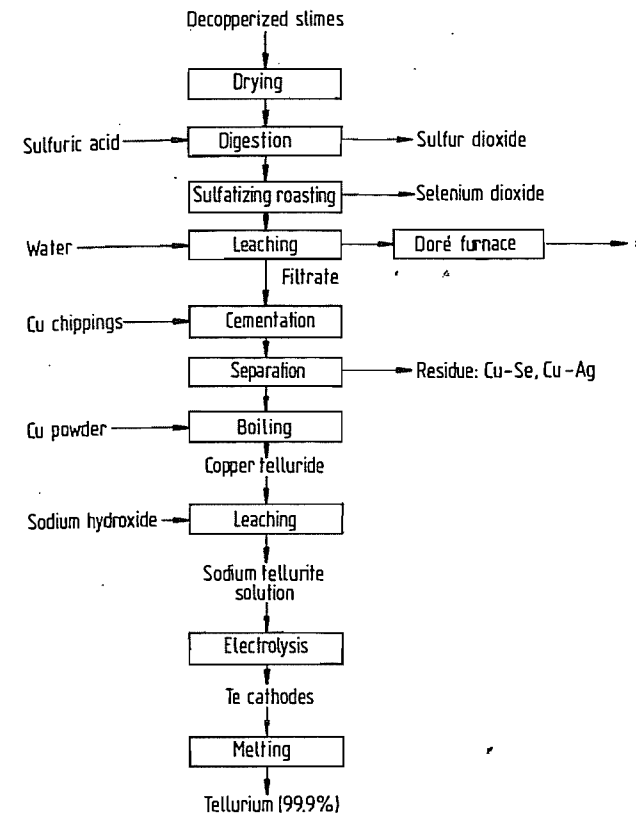
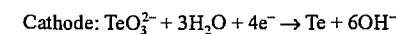
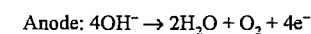

Figure 39.3: Sulfation roasting process. \* As in Figure 39.2.

International Recoveries of the Philippines started producing tellurium dioxide and tellurium metal from copper telluride raw material in 1984, and other complex residues and waste products are now treated. Treatment of a tellurium tetrachloride residue was described in 1989 [31]. Small quantities of thermoelectric scrap are recycled by different tellurium producers.

**Purification.** The following reactions take place during the electrolysis of a tellurite solution:



Typical conditions in an electrolysis cell are: tellurium 100–200 g/L; free sodium hy-

dioxide 40 g/L; current density 160 A/m<sup>2</sup>; temperature 40–50 °C. After drying, melting, and casting in different shapes (or crushing to powder) the commercial tellurium grade is ready for sale. Direct precipitation with zinc is also possible instead of electrowinning.

Further refining consists of vacuum distillation and zone refining, and yields the higher-purity grades 99.99–99.9999%. As zone refining is unsatisfactory for some impurities, e.g., aluminum, bismuth, and iron, another process uses chlorination with HCl to tellurium tetrachloride; distillation and hydrolysis leads to the precipitation of tellurium dioxide of > 99.999% purity, which after reduction with hydrogen gas gives tellurium of the same purity [32].

### 39.6 Quality Specifications

Qualities ranging from 99.5% to 99.9999% tellurium are commercially available. Impurities may be metallic (As, Na, Ca, Pb, Cu, Ni, Sb, Sn, Se, Fe) and nonmetallic (S, Cl, O).

Commercial grades and forms are: 99.5–99.9% (2N5–3N) powder, sticks, or ingots; 99.99% (4N) ingots or lumps; 99.999% (5N) ingots; and 99.9999(9)% (6N–7N) ingots.

Tellurium dioxide powder is available with purity 99.5–99.9%.

### 39.7 Analysis (Table 39.2) [13, 33, 34]

Emission spectrometry (ES) is frequently used for the analysis of standard grade materials up to a purity of 99.99–99.999% (with pre-concentration if necessary). Atomic absorption spectrometry (AAS) is used for analysis down to sub-ppm levels; this method has, however, no multielement capability. AAS can be adapted with a graphite furnace (GFAAS) and coupled with a Zeeman background correction to allow detection limits at  $\mu\text{g/kg}$  levels.

Techniques such as spark source mass spectrometry (SSMS) and glow discharge mass spectrometry (GDMS) offer panoramic elemental capability with low detection limits and maximum selectivity.

Table 39.2: Detection limits obtained by GFAAS, SSMS, and ES,  $\mu\text{g/kg}$ .

Element	GFAAS	SSMS	ES
Ag	10	1.0	100
Al	50	0.8	300
Bi	50	2.0	100
Cu	50	"	200
Fe	50	1.0	200
Mg	20	19	100
Ni	20	1.6	300
Pb	50	1.0	200
Sb	50	1.0	300
Sn	50	4.0	100

\* Interference by doubly charged ions.

### 39.8 Compounds [5, 11, 35–37]

**Tellurium dioxide**,  $\text{TeO}_2$ , is found in the minerals tellurite and paratellurite, which have a rhombic and a tetragonal lattice structure, respectively. It can be formed by burning tellurium in air, or by treating tellurium powder with nitric acid, followed by heating the nitrate:

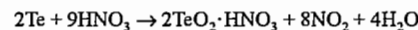

The melting point of  $\text{TeO}_2$  is 1005.8 K (732.6 °C), the clear, dark red liquid oxide vaporizes between 790 and 940 °. Tellurium dioxide is very soluble in water and is amphoteric, the minimum solubility is at pH 3.8–4.2, the isoelectric point. Tellurium dioxide is an important catalyst in oxidation, hydrogenation, and dehydrogenation processes; it is also used in chalcogenide glasses, and as a vulcanizing agent for rubber. Single crystals of  $\text{TeO}_2$  are used in acousto-optic detectors and modulators. Other oxides of tellurium are tellurium monoxide,  $\text{TeO}$ , tellurium trioxide,  $\text{TeO}_3$ , and tellurium pentoxide  $\text{Te}_2\text{O}_5$ ;  $\text{TeO}_3$  exists in a yellow  $\alpha$ -form and a grey  $\beta$ -form.

**Tellurium Halides.** In tellurium halides, Te has valency 2, 4, or 6. Not all the halides are formed— $\text{TeI}_2$  and the  $\text{Te}_2\text{X}_2$  halides do not exist. *Tellurium tetrachloride*,  $\text{TeCl}_4$  forms white hygroscopic needle-like crystals which are soluble in benzene, nitrobenzene, toluene, ethylacetate, and methanol. It is used as a starting material for the synthesis of many organic tellurium compounds, and is also a catalyst for the chlorination of phenol and benzene, and the hydrogenation of acids and esters to alcohols. *Tellurium tetrafluoride*,  $\text{TeF}_4$ , forms white hygroscopic needles. It reacts with water, glass, or silica to tellurium dioxide; metal tellurides are formed with copper, silver, gold, and nickel at 185 °C. Platinum is not attacked below 300 °C.

**Hydrogen telluride**,  $\text{H}_2\text{Te}$ , is a colorless, unstable gas which decomposes above 0 °C and is prepared by electrochemical reduction of tellurium, or by the addition of hydrochloric acid to  $\text{Al}_2\text{Te}_3$ . It is used in the production of heavy metal tellurides.

**Tellurous acid**,  $\text{H}_2\text{TeO}_3$ , is obtained by reaction of alkali tellurites with nitric acid, or by hydrolysis of a tellurium tetrahalide. *Orthotelluric acid*,  $\text{H}_6\text{TeO}_6$ , is made by oxidizing tellurium or tellurium dioxide. It is used in some chemical processes. *Sodium telluride*,  $\text{Na}_2\text{TeO}_3$ , improves the corrosion resistance of electroplated nickel layers. Solutions of *sodium tellurate*,  $\text{Na}_2\text{TeO}_4$ , containing  $\text{Cu}^{2+}$  ions are used for black or blue-black coatings on iron, steel, aluminum, and copper.

A large number of *metal tellurides* are known, and many are semiconductors (Table 39.3). The tellurides are used in infrared detectors ( $\text{Cd}_x\text{Hg}_{1-x}\text{Te}$ ,  $\text{PbTe}$ , and  $\text{Pb}_{1-x}\text{Sn}_x\text{Te}$ ) and laser diodes ( $\text{PbTe}$  and  $\text{Pb}_{1-x}\text{Sn}_x\text{Te}$ ), thermoelectric elements ( $\text{PbTe}$ ,  $\text{Bi}_2\text{Te}_3$ ,  $\text{Sb}_2\text{Te}_3$ ,  $\text{GeTe}$ ), solar cells ( $\text{CdTe}$ ), and  $\gamma$ -ray detectors ( $\text{CdTe}$ ).

### 39.9 Uses

Consumption of tellurium (in t) according to end use in the western world in 1990 was estimated as follows [38]:

Steel additives	145
Nonferrous metals additives	55
Chemicals	45
Electronics	20
Others	5
Total	270

The machinability of steel can be improved by the addition of small quantities (up to 0.1%) of tellurium [39–42], added during the refining of leaded and/or resulfurized, or low-carbon steel in the form of powder, sticks, or cored wire. Manganese telluride alloys are most frequently used nowadays. Additions to cast iron help control the chill depth of rapidly

cooled surfaces and produce hard, wear-resistant top layers.

Tellurium steels and chilled castings are used in the automotive industry, in industrial machinery and tools, in mining, and in railroad equipment.

Many other positive effects of tellurium additions, e.g., deoxidation of liquid steel, refining of the grain size of castings, improvement of the magnetic anisotropy in electrical steels, and improvement of machinability of powder metallurgy steel have been reported.

The use of tellurium in steel could be affected because of decreased consumption of leaded steels owing to environmental constraints.

Traces of tellurium are added to many nonferrous metals [39, 41–43]. The tellurium content is mostly less than 1%. Tellurium–copper (which also contains some phosphorus) reduces cutting resistance, tool wear, heat of cutting, and chip size. It is used in forging, automotive radiators, vacuum applications, and as electrical, motor, and switch parts. Tellurium–copper can replace lead–copper in plumbing, as the latter is under environmental pressure in some countries.

Tellurium–lead is used in the sheathing of power and marine cables and in chemical equipment piping (mostly where sulfuric acid is used). In lead acid batteries, tellurium helps strengthen the battery grids. Other nonferrous alloys are tellurium bronze, tellurium–tin, tellurium–chromium, and tellurium–magnesium. Tellurium–cobalt–titanium is used in permanent magnets.

Table 39.3: Important tellurides and their properties.

Formula	Crystal type	Density, $\text{g/cm}^3$	Band gap at 300 K, eV	Carrier mobility at 300 K, $\text{cm}^2\text{V}^{-1}\text{s}^{-1}$		Melting point, °C
				$\mu_n$	$\mu_p$	
$\text{CdTe}$	cubic	5.86	1.5	1000	95	1092
$\text{HgTe}$	cubic	8.2	0.15	25 000	350	670
$\text{PbTe}$	cubic	8.16	0.29	1800	900	924
$\text{ZnTe}$	cubic	5.7	2.26	530	900	1238
$\text{Bi}_2\text{Te}_3$	hexagonal	7.86	0.15	1300	1200	588.5
$\text{Sb}_2\text{Te}_3$	hexagonal	6.52	0.24		360	621.5
$\text{GeTe}$	face-centered cubic	6.2	0.1		180	724

Tellurium is used in combination with other components in many catalysts. The chemical reactions involved are oxidation, ammoxidation, hydrogenation and dehydrogenation, halogenation and dehalogenation, and phenol condensation [44]. The two major industrial applications are the Nitto process: (acrylonitrile ammoxidation) and the Mitsubishi process (tetramethylene glycol synthesis) [45]:  
**Nitto:** acrylonitrile ammoxidation catalyst:

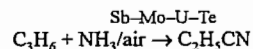

**Mitsubishi:** tetramethylene glycol synthesis (Ac = acetate):

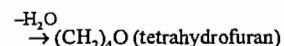
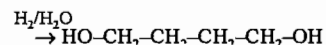
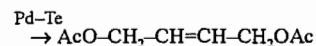
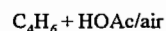

Tellurium is used as a secondary vulcanizing agent in natural, styrene-butadiene, and isobutylene-isoprene rubber [39, 41, 46]. The tellurium rubbers have improved aging and mechanical properties, and better resistance to heat and abrasion. They are used in portable cables, automobile tires, door and window seals, double glazing, and in conveyor belts for special applications. The use of tellurium in rubber has declined over the past few decades, and there is concern over the toxicity of tellurium handling in rubber production, which could further affect its usage.

Other uses of tellurium in chemistry are in heat- and vacuum-stable lubricants for electronics and aerospace applications, metal coatings for silverware, aluminum, and brass, in glass, pigments and fungicides, and in organic derivatives and radioactive isotopes for medicine and biology. Lately, the role of tellurium as a possible regulator in cholesterol synthesis has been studied [47].

In electronics, tellurium is a well-known additive in selenium(-arsenic) photoreceptors [48, 49]. Tellurium has the property of increasing the sensitivity and broadening the

spectral response of the photoreceptor. Since organic photoconductors have been taking over the photocopier and laser printer market, starting with the slower machines (up to 20–30 pages per minute), the use of selenium-tellurium alloys is decreasing markedly, especially in the industrialized countries.

Polycrystalline cadmium telluride is used in photovoltaic solar cells [50]. CdTe has a direct band gap of 1.5 eV, which is optimal for solar energy conversion, and a high optical absorption coefficient. Research into higher efficiencies, lower cost, and better reliability has intensified in recent years, and the future of CdTe solar cells looks very promising. By the year 2000, the use of tellurium in solar cells could be more than 50 t/a [51].

Bismuth telluride and lead telluride are thermoelectric materials [52, 53]. Thermocouples of these materials convert electricity into heat (Peltier effect) and heat into electricity (Seebeck effect). In these thermocouples, dopants such as Sb and Se are needed to make *n*- and *p*-type materials.

$\text{Bi}_2\text{Te}_3$  is mostly used below 200 °C, PbTe at 200–500 °C. The efficiency of a thermoelectric material is expressed by its figure of merit *Z*, a function of the thermal and electrical conductivity and the Seebeck coefficient.

Thermoelectricity has found many applications in picnic boxes, water and food coolers, fiber optic circuits, blood analyzers, and other precision temperature control instruments, remote power generators, solar energy conversion, military equipment (e.g., refrigeration systems in submarines and infrared detectors), and aerospace. Especially the low-tech applications, such as picnic boxes and car drink coolers, have seen a steady rise in sales.

Now that systems based on chlorofluorocarbons are increasingly banned from refrigerators and air-conditioning devices, owing to their detrimental effect on the ozone layer, thermoelectricity could offer a viable alternative, but the present efficiency of the coolers is still too low and the cost too high to suggest a rapid growth in large cooling systems [54].

Optical disks are powerful tools for storing vast quantities of digitized information (up to

1 Gbyte). Different types of write-only and erasable disks exist, and some of their active layers use tellurium alloys which are sputtered onto the disk by vapor deposition techniques from targets containing, e.g., Te-Ge-Sb or Te-Se-Sb [55].

Cadmium-, cadmium zinc-, and cadmium selenium telluride single crystals are used in several electronic applications:  $\gamma$ -ray detectors for medical diagnostics and dosimetry, nonlinear optics, infrared electro-optic modulators, and photorefractive devices [34, 56]. These crystals are grown by vertical or horizontal Bridgman techniques, or the traveling heater method. They are also used as substrates for epitaxial cadmium mercury telluride ( $\text{Cd}_x\text{Hg}_{1-x}\text{Te}$ ) thin film detectors for infrared imagers [57], of which lead tin telluride ( $\text{Pb}_x\text{Sn}_{1-x}\text{Te}$ ) is an example. The detectors operate in the spectral ranges 3–5  $\mu\text{m}$  and 8–14  $\mu\text{m}$ . The thin films are grown by methods such as liquid phase epitaxy, organometallic vapor phase epitaxy, or molecular beam epitaxy [34]. The devices are normally cooled to 77 K with liquid nitrogen. The new generations of imagers use two-dimensional focal plane arrays to capture an entire image at once.

Research and development literature focuses on the different uses of tellurium in non-ferrous alloys (35%), optical storage (10%), cadmium- and cadmium mercury tellurides (20%), and 35% other applications.

### 39.10 Economic Aspects

World production of tellurium in 1990 has been estimated at 306 t. The estimated production (in t/a) by country and company for 1990 is listed below:

Japan	
Mitsubishi Metal	22
Mitsui Mining & Smelting	10
Nippon Mining & Smelting	12
Sumitomo Metal Mining	12
Belgium	
Union minière	90
Canada	
Noranda Mines	15
United States	
Asarco	40
Philippines	
Pacific Rare Metal	35

Former Soviet Union	50
Peru	10
China	10
Total	306

The main producers are in Belgium, the United States, the Commonwealth of Independent States, and the Philippines [41].

Figure 39.4 shows the evolution of the average annual price for standard-grade tellurium (99.5%) [41]. Tellurium 99.99% is normally 40–50% more expensive, 99.999% is more than double the standard-grade price, and  $\geq 99.9999\%$  ranges from 400 to \$1200/kg.

The world economic recession of the early 1990s, particularly hitting the steel industry, and cheap material from the Commonwealth of Independent States, led to a price erosion of 50% between 1990 and 1993.

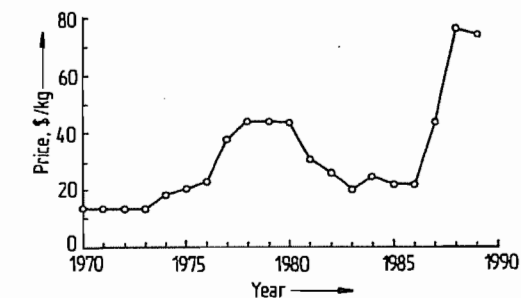

Figure 39.4: Average annual price for standard-grade tellurium (99.5%).

### 39.11 Toxicology and Occupational Health [58–62]

Elemental tellurium is considered to be less toxic than selenium. Organic compounds and reactive tellurides can be a health hazard. Hydrogen telluride ( $\text{H}_2\text{Te}$ ) and tellurium hexafluoride ( $\text{TeF}_6$ ) are both highly toxic, colorless gases. Some  $\text{LD}_{50}$  values on ingestion of tellurium compounds are listed in Table 39.4. On the basis of new data for the  $\text{LD}_{50}$  value for elemental tellurium, the Environmental Protection Agency of the United States has been asked to declassify tellurium as extremely hazardous [62].

Table 39.4: LD<sub>50</sub> values for different tellurium compounds.

Compound	Animal	Administration	LD <sub>50</sub> , mg/kg
Te	rat, mouse	oral	> 5000
TeO <sub>2</sub>	unspecified	oral	> 3000
Na <sub>2</sub> TeO <sub>3</sub>	white mouse	oral	20
Na <sub>2</sub> TeO <sub>4</sub>	white mouse	oral	165

The acute inhalation toxicity value LC<sub>50</sub> (4 h) for rats is > 2.42 g/m<sup>3</sup>, the maximum attainable concentration [63].

Tellurium intoxication in the working environment can occur through inhalation and ingestion. No irritation of skin or eyes has been reported for elemental tellurium and tellurium dioxide. Exposure to tellurium fumes and dust cause a garlic odor of the breath and malaise, dryness of the mouth and metallic taste, anorexia, occasional nausea, and some other symptoms. Tellurium is accumulated in the liver, kidneys, bones, and neural cells. The elimination of tellurium in breath, sweat, urine, and feces is very slow. The typical garlic odor seems to result from the partial elimination of tellurium through the lungs as dimethyl telluride (CH<sub>3</sub>)<sub>2</sub>Te; it can be suppressed temporarily by administration of vitamin C (ascorbic acid), but the vitamin C may also enhance the toxic effects. Tellurium hexafluoride can cause a bluish-black pigmentation of the skin.

Tellurium intoxication symptoms do not appear when the tellurium concentration in the air is < 0.01 mg/m<sup>3</sup> and in the urine < 1 µg/L. The TLV for tellurium and its compounds is 0.1 mg/m<sup>3</sup> (calculated as tellurium). The TLV was established to prevent poisoning, but garlic breath may still occur. There is no specific antidote for tellurium poisoning.

There are no indications of carcinogenic, teratogenic, or mutagenic effects of tellurium or its compounds.

Unlike selenium, tellurium is not an essential trace element for humans or animals. Tellurium and its compounds cannot be used in cosmetics.

## 39.12 References

1. Gmelin, Suppl. A1, p. 205.

2. S. C. Carapella, Jr., in W. C. Cooper (ed.): *Tellurium*, Von Nostrand Reinhold Co., New York 1971, p. 1.
3. Ullmann, 4th ed., 22, 447.
4. *Handbook of Chemistry and Physics*, 66th ed., The Chemical Rubber Co., Cleveland, OH, 1985/1986.
5. J. C. Bailar et al.: *Comprehensive Inorganic Chemistry*, 1st ed., Pergamon Press, Oxford 1973, pp. 935–1009.
6. Kirk-Othmer, 22, 659–661.
7. S. C. Carapella, Jr.: *Metals Handbook*, 9th ed., vol. 2, American Society for Metals, Metals Park, OH, 1979, p. 806.
8. W. M. Becker, V. A. Johnson, A. Nussbaum in W. C. Cooper (ed.): *Tellurium*, Von Nostrand Reinhold Co., New York 1971, pp. 54–109.
9. D. M. Chizhikov, V. P. Shchastlivyi: *Tellurium and Tellurides*, Collet's Ltd., London 1970, pp. 1–30.
10. H. Lumbroso in P. Pascal (ed.): *Compléments au Nouveau Traité de chimie minérale*, vol. 8, Masson, Paris 1977, pp. 17–68.
11. W. A. Dutton in W. C. Cooper (ed.): *Tellurium*, Von Nostrand Reinhold Co., New York 1971, pp. 110–183.
12. I. Barin: *Thermochemical Data of Pure Substances*, part II, VCH Verlagsgesellschaft, Weinheim 1989.
13. M. Caffarey, *Proc. 8th Conf. on Thermoelectric Energy Conversion*, Nancy, France 1989, pp. 40–44.
14. W. C. Cooper (ed.): *Tellurium*, Von Nostrand Reinhold Co., New York 1971, pp. 1–13.
15. D. Edelstein in S. C. Carapella, Jr. (ed.): *Proc. 4th Int. Symp. on Uses of Selenium and Tellurium*, Banff, Canada 1989, pp. 4–13.
16. P. E. Skinner, *Trans. Inst. Min. Metall. Sect. C* 97 (1988) C83–C87.
17. P. H. Jennings in W. C. Cooper (ed.): *Tellurium*, Von Nostrand Reinhold Co., New York 1971, pp. 14–53.
18. Kirk-Othmer, 22, 662–663.
19. R. Bresee, D. Vleeschhouwer, J. Thiriar, *Proc. of the Symp. on Industrial Uses of Selenium and Tellurium*, Toronto, Canada 1980, pp. 31–49.
20. L. E. Hoffmann, *J. Met.* 41 (1989) no. 7, 32–38.
21. J. E. Hoffmann, *J. Met.* 42 (1990) no. 8, 50–54.
22. Ullmann, 4th ed., 22, 448–451.
23. Noranda Inc., CA 2049276, 1991 (P. L. Claessens, C. W. White).
24. Nippon Mining Co., JP 60208431, 1985 (T. Abe, Y. Takazawa).
25. J. E. Dutrizac, T. T. Chen in W. C. Cooper, G. E. Lagos, G. Ugarte (eds.): *Copper 87*, vol. 3, Universidad de Chile, Santiago, Chile 1988, p. 469.
26. T. Shibasaki, K. Abe, H. Takeuchi, *Hydrometallurgy* 29 (1992) 399–412.
27. Mitsubishi Metal Corp., Onahama Seiren Co., JP 01079008, 1989 (Y. Sugawara, J. Konishi, S. Hayashi, M. Hayashi).
28. Mitsubishi Materials Corp., US 5160588, 1992 (T. Shibasaki, K. Abe, H. Takenchi).
29. Nippon Shin Kinzuko K.K., JP 56084428, 1981.
30. Interlox Chemicals, EP 127357, 1984 (A. Broome).
31. R. J. Hisshion in S. C. Carapella, Jr. (ed.), *Proc. 4th Int. Symp. on Uses of Selenium and Tellurium*, Banff, Canada 1989, pp. 25–30.
32. Sumitomo Metal Mining Co., JP 63285106, 1988, JP 63286531, 1988 (M. Yukinobu, J. Oowa).
33. K. Swenters, J. Verlinden, R. Gijbels, *Fresenius Z. Anal. Chem.* 335 (1989) 900–904.
34. D. R. Nichols, B. E. Dean, C. J. Johnson in S. C. Carapella, Jr. (ed.): *Proc. 4th Int. Symp. on Uses of Selenium and Tellurium*, Banff, Canada 1989, pp. 282–299.
35. Ullmann, 4th ed., 22, 451–452.
36. D. M. Chizhikov, V. P. Shchastlivyi: *Tellurium and Tellurides*, Collet's Ltd., London 1970, pp. 145–259.
37. *The Economics of Tellurium 1991*, 4th ed., Roskill Information Services, London 1991, pp. 65–66.
38. E. Hoyne, *The Bulletin of Selenium-Tellurium Development Association, Inc.*, Sept. 1989, pp. 1–4.
39. Kirk-Othmer, 22, 671–676.
40. E. S. Nachtman in W. C. Cooper (ed.): *Tellurium*, Von Nostrand Reinhold Co., New York 1971, pp. 373–409.
41. *The Economics of Tellurium 1991*, 4th ed., Roskill Information Services, London 1991, pp. 51–98.
42. R. J. Raudebaugh, *Proc. of the Symp. on Industrial Uses of Selenium and Tellurium*, Toronto, Canada 1980, pp. 201–221.
43. P. W. Taubenblat, *Proc. of the Symp. on Industrial Uses of Selenium and Tellurium*, Toronto, Canada 1980, pp. 267–276.
44. W. C. Cooper (ed.): *Tellurium*, Von Nostrand Reinhold Co., New York 1971, pp. 410–430.
45. T. A. Koch in S. C. Carapella, Jr. (ed.): *Proc. 4th Int. Symp. on Uses of Selenium and Tellurium*, Banff, Canada 1989, pp. 661–672.
46. W. R. McWhinnie, J. E. Stuckey, K. G. Karnika Da Silva, *Proc. of the 3rd Int. Symp. on Industrial Uses of Selenium and Tellurium*, Stockholm, Sweden 1984, pp. 206–245.
47. A. D. Toews, S. Y. Lee, B. Popko, P. Morell, *J. Neurosci. Res.* 26 (1990) 501–507.
48. L. Cheung, G. M. Foley, P. Fournia, B. E. Springett, *Photogr. Sci. Eng.* 26 (1982) no. 5, 245–249.
49. R. C. Norton, *Proc. 7th Annual Photoreceptor & Components Conf.*, Santa Barbara, United States 1991.
50. K. Zweibel: "Toward Low Cost CdTe PV, NREL/TP413-4841", National Renewable Energy Laboratory, Golden, CO, April 1992.
51. M. C. King, Workshop Report. *Recycling of Cadmium and Selenium from Photovoltaic Modules and Manufacturing Wastes*, Golden, United States 1992, pp. 90–101.
52. C. H. Champness in W. C. Cooper (ed.): *Tellurium*, Von Nostrand Reinhold Co., New York 1971, pp. 322–372.
53. D. P. Burton, *Proc. 9th Int. Conf. on Thermoelectrics*, Pasadena, United States 1990, pp. 109–123.
54. P. M. Schicklin, *Proc. 9th Int. Conf. on Thermoelectrics*, Pasadena, United States 1990, pp. 381–395.
55. M. Hartmann, B. A. Jacobs, *Philips Tech. Rev.* 42 (1985) no. 2, 37–47.
56. M. Ohmori, Y. Iwase, R. Ohno, *Proc. Symposium on New Aspects of the Growth, Characterization and Applications of CdTe and Related Cd Rich Alloys of the 1992 E-MRS Spring Conf.*, Strasbourg, France 1992, pp. 283–290.
57. C. Lucas, *Sens. Actuators A* 25–27 (1991) 147–154.
58. J. R. Glover, V. Vouk in L. Friberg et al. (eds.): *Handbook on the Toxicity of Metals*, Elsevier/North Holland Biomedical Press, Amsterdam 1979, chap. 35, pp. 587–598.
59. W. C. Cooper in W. C. Cooper (ed.): *Tellurium*, Von Nostrand Reinhold, New York 1971, pp. 313–321.
60. Ullmann, 4th ed., 22, 453.
61. Kirk-Othmer, 3rd ed., 22, 666.
62. Environmental Outlook, vol. 3, no. 1, *Selenium-Tellurium Development Assoc.*, Grimbergen, Belgium 1992.
63. TNO Report V 92.008, TNO-Voeding, Zeist, Holland, Jan. 1992.

## Part Nine

### Radioactive Metals

																H	He				
Li	Be															B	C	N	O	F	Ne
Na	Mg	Al														Si	P	S	Cl	Ar	
K	Ca	Sc	Ti	V	Cr	Mn	Fe	Co	Ni	Cu	Zn	Ga	Ge	As	Se	Br	Kr				
Rb	Sr	Y	Zr	Nb	Mo	Tc	Ru	Rh	Pd	Ag	Cd	In	Sn	Sb	Te	I	Xe				
Cs	Ba	La <sup>†</sup>	Hf	Ta	W	Re	Os	Ir	Pt	Au	Hg	Tl	Pb	Bi	Po	At	Rn				
Fr	Ra	Ac <sup>‡</sup>																			

†	Ce	Pr	Nd	Pm	Sm	Eu	Gd	Tb	Dy	Ho	Er	Tm	Yb	Lu
---	----	----	----	----	----	----	----	----	----	----	----	----	----	----

‡	Th	Pa	U	Np	Pu	Am	Cm	Bk	Cf	Es	Fm	Md	No	Lr
---	----	----	---	----	----	----	----	----	----	----	----	----	----	----

## 40 General

HERIBERT LUIG (§ 40.1–40.3); CORNELIUS KELLER † (§ 40.4); JØRGEN GRIEBEL, ALBRECHT M. KELLERER (§ 40.5)

40.1 History	1585	40.4.4 Francium	1592
40.2 The Law of Radioactive Decay	1587	40.4.5 Radium and Radon	1593
40.3 Activity	1587	40.4.6 Actinium	1593
40.4 Radioactive Elements	1588	40.4.7 Protactinium	1594
40.4.1 Promethium	1588	40.5 The Biological Effects of Radiation and Radionuclides	1595
40.4.2 Technetium	1589	40.6 References	1597
40.4.3 Polonium	1591		

### 40.1 History

**1896: Discovery of Radioactivity.** H. BECQUEREL discovered radioactivity one year after the discovery of X rays. Using photographic plates to study the fluorescence of uranium compounds, BECQUEREL found that uranium blackened plates even after a long period in the dark. Fluorescence, therefore, cannot be the cause of the blackening; the radiation comes spontaneously from the uranium, without prior excitation.

*Radio-Thorium.* MARIE CURIE made a systematic study of all elements to investigate which ones emit the newly discovered radiation. She discovered that thorium, two atomic numbers away from uranium, is also “radioactive”.

*First Activity Unit, the Curie (Ci).* In quantitative investigations with a galvanometer, M. CURIE found that the intensity of the radiation from uranium (the radioactivity) is proportional to the quantity of uranium.

**1898: Polonium.** From the pitchblende ore of a uranium deposit, M. CURIE isolated an element with atomic mass 210. She proposed the name “polonium” after her homeland.

**1898: Radium.** PIERRE and MARIE CURIE found element 88 in pitchblende from Joachimsthal and named it “radium”.

**1899: Birth of Nuclear Physics.** ELSTER and GEITEL stated the hypothesis that radioactivity originates from the transmutation of elements.

This hypothesis has ultimately become the basis for nuclear physics.

**1899: Alpha and Beta Radiation.** By measuring ranges, Rutherford determines that radioactive radiation consists of at least two distinct components which are designated  $\alpha$  and  $\beta$ .

**1903: Nobel Prize for Research on Radioactivity.** H. BECQUEREL, M. SKLODOWSKA-CURIE, and P. CURIE shared the Nobel Prize for Physics.

**1903: Gamma Radiation.** The third component of radioactivity, called  $\gamma$  radiation, was first reported in 1903 and later described in 1906 by P. VILLARD.

**1905: Gamma Quanta.** EINSTEIN postulated the existence of corpuscular light quanta (photons) and explained the photoelectric effect. Einstein’s postulate also explains the character of  $\gamma$  quanta.

**First Decade of the 20th Century: Identification of Alpha and Beta Particles.** The *particle* was identified in 1903 by DES COURCELLES, who determined the ratio of mass to charge of this particle, and in 1908 E. REGENER measured the charge. The  $\alpha$  particle is found to have a mass identical to that of the helium nucleus. This result supplements the observation made by RAMSEY and SODDY (1903) that the noble gas helium is generated from “radium emanation”; this observation in turn supports ELSTER and GEITEL’s 1899 thesis of transmutation. In 1909, RUTHERFORD also

showed by spectroscopic measurements that  $\alpha$  particles are helium nuclei.

For  $\beta$  particles, the deflection in electric and magnetic fields gives the ratio of charge to mass (KAUFMANN) and showed that the specific charge is the same as that of cathode rays, i.e., electrons.

**1906: Equivalency of Mass and Energy.** EINSTEIN stated that mass and energy are equivalent and can be transformed into each other. This equivalence is fundamental to all phenomena of radioactivity and nuclear physics.

**1907: Three New Radioactive Elements.** OTTO HAHN discovered the radioactive elements radiothorium, radioactinium, and "mesothorium" I and II.

**1909: Isotropy.** F. SODDY reported that lead atoms have different masses. The phenomenon of isotropy had not yet been explained until the discovery of the neutron in 1932.

**1911: Second Nobel Prize for M. SKLODOWSKA-CURIE.** M. SKLODOWSKA-CURIE received the Nobel Prize in Chemistry for the discovery of radium and polonium.

**1911: The Atomic Nucleus.** Rutherford's model of the atom has a small, heavy nucleus surrounded by a shell of electrons.

**1913: Charge and Size of the Atomic Nucleus.** H. GEIGER and E. MARSDEN obtained experimental confirmation of the Rutherford atomic model by measuring the charge and size of the nuclei.

**1913: The Hydrogen Atom; Planck's Constant.** NIELS BOHR described a planetary model of the atom. The spectral lines of the hydrogen atom were calculated with the help of Planck's constant.

**1918: Protactinium.** O. HAHN and L. MEITNER discovered the radioactive element protactinium.

**1919: Discovery of the First Artificial Nuclear Reaction.** While studying the range of  $\alpha$  particles in nitrogen, RUTHERFORD observed components having a longer range but a lower

signal intensity on the scintillation screen. RUTHERFORD interpreted these unexpected components as protons:

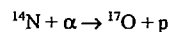

**1923: Compton Effect.** A. H. COMPTON showed that X-ray quanta collide with electrons like discrete particles (1927 Nobel Prize).

**1925: Pauli Exclusion Principle.** The exclusion principle of W. PAULI, which holds for particles with spin  $1/2$  and thus in particular for electrons in the atomic shell, explains the periodic system of the elements. It has also accounted for the nuclear systematics in the framework of the shell model. Protons and neutrons are also spin  $1/2$  particles.

**1926: Fermi Statistics.** Fermi statistics apply to all spin  $1/2$  particles ("fermions"), thus in particular to electrons and neutrons.

**1927: Chemical Bonding.** W. HEITLER and F. LONDON accounted for chemical bonding on a quantum-physical basis.

**1927: Betatron Principle.** R. WIDERÖE and F. STEENBECK described the betatron principle for accelerating electrons.

**1928: Spin and Magnetic Moment of the Electron.** P. A. M. DIRAC explained the angular momentum and magnetic moment of the electron by introducing the laws of relativity theory to extend quantum wave mechanics.

**1928: Heisenberg's Uncertainty Principle.** HEISENBERG stated that in the world of elementary particles, position and momentum cannot both be determined simultaneously.

**1930: Prediction of the Positron.** In the framework of his extended quantum theory, DIRAC predicted the existence of the positron, which was discovered experimentally in 1932.

**1930: Cyclotron.** E. LAWRENCE constructed the cyclotron.

**1932: Discovery of the Positron.** C. D. ANDERSON discovered the positron.

**1932: Discovery of the Neutron.** JAMES CHADWICK discovered the neutron. Nuclei consist of neutrons and protons.

**1932: First Artificially Induced Nuclear Reaction.** The first nuclear reaction initiated by artificially accelerated particles (150 keV protons) was accomplished by J. D. COCKROFT and E. T. S. WALTON. They received the Nobel Prize in 1951.

**1932: Deuterium.** H. C. UREY discovered deuterium (Nobel Prize 1934).

**1932: Pair Production.** I. CURIE and F. JOLIOT discovered pair production with the postulate that a  $\gamma$  quantum transforms into an electron-positron pair; mass and energy are equivalent (EINSTEIN, 1906).

**1934: Annihilation Radiation.** THIBAUD and JOLIOT discovered the emission of annihilation radiation when a positron and an electron interact and subsequently produce two  $\gamma$  quanta. As in the case of pair production, mass and energy are equivalent (EINSTEIN, 1906).

**1934: Artificial Radioactivity.** I. CURIE and F. JOLIOT discovered artificial radioactivity.

**1934: Neutron-Induced Nuclear Reactions.** E. FERMI initiated nuclear reactions with neutrons.

**1934: Neutrino Theory.** E. FERMI postulated the existence of the neutrino in order to account for  $\beta$  decay.

**1935: Betatron.** M. STEENBECK constructed the betatron, an electron accelerator.

**1937: The  $\mu$  Meson.** The  $\mu$  meson, predicted in 1935 by YUKAWA, was discovered in cosmic rays.

**1937: Technetium.** G. PERRIER and E. SGRÉ discovered element 43, technetium, as a nuclear reaction product. Because of its half-life of  $4.2 \times 10^6$  a ( $^{98}\text{Tc}$ ) or 210 000 a ( $^{99}\text{Tc}$ ) is short on a cosmological scale, the element has never been found in nature. It is, however, certainly present in nature as a product of the very rare spontaneous fission of uranium.

**1938: Neutron-Induced Nuclear Fission.** HAHN and STRASSMANN discovered that the ura-

nium nucleus can be induced to fission by neutron bombardment.

**1942: Chain Reaction.** E. FERMI achieved the first nuclear chain fission reaction.

## 40.2 The Law of Radioactive Decay

In a tennis game, the ball occasionally lands among the spectators. This is neither the point of the game nor the intent of the players, it is a random event in the dynamics of play. When it will occur cannot be predicted; there is merely a certain probability that it will happen.

Comparable with the dynamics of a tennis game are the internal dynamics of an individual radioactive nuclide, which lives with the permanent risk of losing, e.g., four nucleons (an  $\alpha$  particle in this situation) all at once. The nuclide suffers this loss at an unpredictable time and without external stimulation. Radioactive nuclides undergo such changes spontaneously, and radioactive decay must be regarded as a stochastic process.

The behavior of the stochastic occurrence in time is characterized by a decay constant  $\lambda$ . This constant is defined as a probability per unit time, specifically the (infinitesimal) probability  $d\omega$  that a certain individual nucleus will decay in the infinitesimal time  $dt$ :

$$\lambda = d\omega/dt$$

or

$$d\omega = \lambda dt$$

The decay constant  $\lambda$  has the following properties:

- It is equal for all nuclides of a given species
- It is constant over time; Nuclides do not "age" and do not have any history

## 40.3 Activity

The physical quantity "activity" is defined as the number of decays per unit time. Since 1985, the unit of activity has been the number of decays per second:



$$A = \text{decays} \cdot \text{s}^{-1}$$

Its special name since 1985 has been the becquerel (Bq):

$$1 \text{ Bq} = 1 \text{ decay} \cdot \text{s}^{-1}$$

Up to 1950, the unit of activity was defined in terms of the activity of 1 g of uranium (special name: curie (Ci) after M. CURIE, who discovered the proportionality between the mass of radioactive uranium and the "intensity" of radiation). This definition was made numerically exact in 1950:

$$1 \text{ Ci} = 1.700 \times 10^{10} \text{ decays} \cdot \text{s}^{-1}$$

By international convention, the unit curie may no longer be employed, but is, however, still frequently encountered. However, since radioactive decay is a stochastic process, sequential measurements of a radioactive source over time will not yield count rates  $I(t)$  that correspond exactly to the exponential law  $I(t) = I(0)e^{-\lambda t}$ . The exponential law describes only the time dependence of the "expected" value  $I(t)$ . The individual measurements  $\hat{I}(t_i)$  are Poisson distributed about the expected value  $I(t_i)$ . For "not too low" count rates  $\hat{I}$  ( $\hat{I} > 20$ ), typical of all technical uses of radioactive sources, the skew-symmetric Poisson distribution can be replaced, to a good approximation, by the symmetric Gaussian normal distribution.

## 40.4 Radioactive Elements<sup>1</sup>

### 40.4.1 Promethium

Promethium ( $Z = 61$ ) was discovered after 1945 as a product of  $^{235}\text{U}$  fission by neutrons (J. A. MARINSKY, L. E. GLENDENIN, C. D. CORYELL). The isotopes  $^{130}\text{Pm}$  to  $^{153}\text{Pm}$  are known, but only  $\beta^-$ -active  $^{147}\text{Pm}$  ( $t_{1/2} = 2.62 \text{ a}$ ) has found some industrial importance.  $^{145}\text{Pm}$  ( $t_{1/2} = 17.7 \text{ a}$ ) is the longest-lived promethium isotope but it can only be produced by nuclear

<sup>1</sup> Astatine, the heaviest halogen, a radioactive element ( $Z = 85$ ), was discovered in 1940, and occurs in minute amounts as a short-lived intermediate product in the decay of  $^{235}\text{U}$  and  $^{238}\text{U}$ . Of no metallurgical interest.

reactions involving accelerators and is, therefore, only available in tracer quantities.

$^{147}\text{Pm}$  is obtained from high active waste solutions of the PUREX process, together with other fission lanthanides. The waste solution is stored for at least several years and then extracted by a solution of di-(2-ethylhexyl)phosphoric acid in kerosene. Pure  $^{147}\text{Pm}$  is subsequently separated by adsorption to a cation exchanger followed by elution with solutions of complexing agents such as nitrilotriacetic acid or ethylene diaminetetraacetic acid.

In its chemical and physical behavior, promethium (electronic configuration  $[\text{Xe}] 4f^{14} 6s^2 p^1$ ) is a typical trivalent rare earth element.

Promethium crystallizes in the double-hexagonal close-packed (dhcp) structure ( $a = 365 \text{ pm}$ ,  $c = 1165 \text{ pm}$ ) and has a melting point of  $1168 \text{ }^\circ\text{C}$ . It is produced either by reduction of  $\text{PmF}_3$  using calcium as a reductant

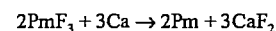

or in purer form by reduction of  $\text{Pm}_2\text{O}_3$  with metallic thorium and subsequent sublimation and condensation.

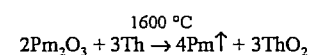

**Uses.** All uses of  $^{147}\text{Pm}$  are based on its inherent radioactivity. The heat released on  $^{147}\text{Pm}$  decay ( $0.3 \text{ W/g } ^{147}\text{Pm}$ ) can be transformed into electric energy in isotope batteries via the thermoelectric effect. Backscattering of the electrons emitted by  $^{147}\text{Pm}$  is applied for determination of the thickness of material that is composed of elements with low  $Z$ , for example a plastic cover on a metallic substrate.

Intimate mixtures of  $^{147}\text{Pm}_2\text{O}_3$  and phosphors such as  $\text{ZnS}(\text{Cu})$  are widely applied as luminescence materials for watches and space modules.

**Handling.**  $^{147}\text{Pm}$  is a soft  $\beta$  emitter ( $E_{\beta(\text{max})} = 225 \text{ keV}$ ) so no special radiation shielding measures are necessary. However, when handling solid compounds in powder form tight glove boxes must be used to avoid contamination.

### 40.4.2 Technetium

Technetium (Tc,  $Z = 43$ ), the lightest radioelement was discovered by G. PERRIER and E. SEGRÉ in 1937 after irradiation of molybdenum with deuterons at the Berkeley cyclotron (United States). SEGRÉ took the irradiated sample to Palermo (Italy) where he and PERRIER probably separated the isotope  $^{97\text{m}}\text{Tc}$  ( $t_{1/2} = 90 \text{ d}$ ).

In 1992, all isotopes between mass numbers  $M = 89$  [prepared by the reaction  $^{60}\text{Ni}(^{32}\text{S}, p2n)$ , with  $t_{1/2} = 12.8 \text{ s}$ ] and  $M = 111$  (prepared by fission of  $^{233}\text{U}$  after bombardment with 20 MeV protons,  $t_{1/2} = 0.30 \text{ s}$ ) were identified.  $^{93}\text{Tc}$  ( $t_{1/2} = 4.2 \times 10^6 \text{ a}$ ) is the longest-lived isotope but it cannot be obtained in weighable amounts. The isotope  $^{99}\text{Tc}$  ( $t_{1/2} = 2.14 \times 10^5 \text{ a}$ ) is used for chemical and physical studies of technetium and obtained by fission of  $^{235}\text{U}$  with thermal neutrons in ca. 6% yield. This corresponds to formation of 2.8 g technetium per day and 100 MW<sub>th</sub> power of a nuclear reactor (i.e., about 30 kg/a in a modern 1300 MW<sub>e1</sub> nuclear power reactor).  $^{99}\text{Tc}$  can be recovered from high active waste solutions after reprocessing of spent fuel by the PUREX process.

The most important technetium isotope, however, is  $^{99\text{m}}\text{Tc}$  ( $t_{1/2} = 6.0 \text{ h}$ ) which is currently the most frequently used radionuclide in nuclear medicine. Due to its short half-life, it must be separated from its mother nuclide  $^{99}\text{Mo}$  ( $t_{1/2} = 66 \text{ h}$ ) by the use of a generator at the place of application.

Several types of  $^{99}\text{Mo}/^{99\text{m}}\text{Tc}$  generators exist which can supply sterile  $^{99\text{m}}\text{Tc}$  in high purity and good yield, e.g., by elution of technetium with  $\text{NaCl}$  solution from an alumina column loaded with  $^{99}\text{Mo}$  (Figure 40.1).

$^{99}\text{Mo}$  itself can be produced by two processes:

- Irradiation of  $^{98}\text{Mo}$ -enriched molybdenum in a nuclear reactor via neutron capture  $^{98}\text{Mo}(n, \gamma)^{99}\text{Mo}$

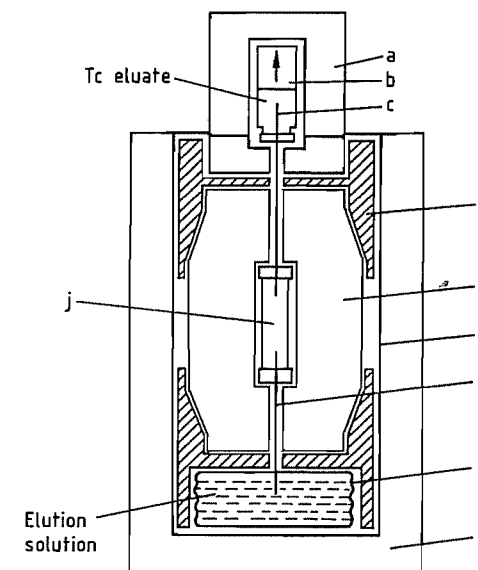

**Figure 40.1:**  $^{99\text{m}}\text{Tc}$  generator "Tecegen" (Hoechst): a) Eluate shielding (lead glass); b) Evacuated eluate bottle, 13 mL, 5 mL calibration; c) Canula for eluate; d) Adapter for eluate; e) Transport shielding; f) Transport box; g) Canula for elution solution; h) Box containing elution solution in plastic container; i) Additional shielding; j) Generator column for fission Mo.

- Irradiation of highly  $^{235}\text{U}$ -enriched ( $\geq 20\%$ ) uranium in a nuclear reactor and separation of the fission product  $^{99}\text{Mo}$  (fission yield  $\approx 6\%$ )

The second type of production is preferred because it yields  $^{99}\text{Mo}$  with a high specific activity so that the eluted  $^{99\text{m}}\text{Tc}$  is obtained in high concentration. In contrast, the product of  $^{98}\text{Mo}$  irradiation only delivers  $^{99}\text{Mo}$  with a much lower specific activity and, therefore, requires larger generators.

Nowadays, an adequate supply of  $^{99\text{m}}\text{Tc}$  is provided by the so-called  $^{99\text{m}}\text{Tc}$  generators. These generators are efficient and reliable and differ principally from common generators in the technique of separating technetium from molybdenum. Preferred separation methods are the adsorption of  $^{99}\text{MoO}_4^{2-}$  onto a solid medium and elution of  $^{99\text{m}}\text{TcO}_4^-$  with saline solution, selective extraction of  $^{99\text{m}}\text{TcO}_4^-$  into organic solvents, and sublimation of ditechne-tium heptaoxide at high temperatures.

Technetium has the ground state electronic configuration of [Kr]  $4d^6 5s^1$ . Its chemical properties are more similar to rhenium than to manganese. Valency states between 1- and 7+ are known, the most stable ones being Tc(IV) and Tc(VII). The most important redox potentials in acidic solution at 298.2 K are:

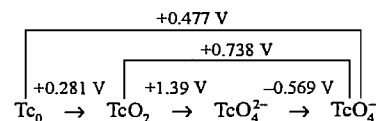

*Metallic technetium* can be easily prepared either by reduction of  $\text{NH}_4\text{TcO}_4$  or  $\text{TcO}_2$  with hydrogen at 700–900 °C or by electrodeposition from a 1 M solution of  $\text{NH}_4\text{TcO}_4$  in sulfuric acid. Its most important *physical properties* are:

<i>mp</i>	2250 ± 50 °C
Density	11.47 g/cm <sup>3</sup>
Crystal structure	hexagonal close-packed
Lattice dimensions (25 °C)	<i>a</i> = 274.07 pm <i>c</i> = 439.80 pm
Critical temperature (superconducting)	7.73 ± 0.02 K
Debye temperature	454 K
Standard entropy of formation	31 ± 0.8 Jmol <sup>-1</sup> K <sup>-1</sup>
Magnetic susceptibility (25 °C)	270 × 10 <sup>-6</sup>
Specific heat <i>C<sub>p</sub></i> (1000 K)	0.29 Jg <sup>-1</sup> K <sup>-1</sup>

**Chemical Properties.** Solid technetium is resistant to oxidation, but in sponge or powder form it is readily oxidized to the volatile hepta-oxide when heated in air. The metal dissolves in dilute or concentrated nitric acid, concentrated sulfuric acid, and bromine water, but not in hydrochloric acid. Technetium also dissolves in aqueous acid hydrogen peroxide solutions. It is oxidized by these solvents to pertechnetate, but in the case of bromine water [ $\text{TcBr}_6$ ]<sup>2-</sup> is also formed.

$\text{TcO}_2$  reacts with fluorine to yield  $\text{TcO}_3\text{F}$ . Contrary to rhenium, no heptafluoride of technetium is known. Only  $\text{TcF}_5$  and  $\text{TcF}_6$  are obtained, for example, by fluorination of technetium metal at 400 °C. The corresponding reaction with chlorine or bromine at 550 °C produces the tetrahalides  $\text{TcCl}_4$  and  $\text{TcBr}_4$ . These halides can form hexahalide complexes with an octahedral  $\text{TcCl}_6^{2-}$  arrangement that are more stable than the corresponding tetrahalides, for example,  $\text{K}_2\text{TcCl}_6$ .

$\text{TcOCl}_4$  and  $\text{TcO}_3\text{Cl}$  are formed if technetium reacts with chlorine that contains oxygen. Sulfur reacts with technetium at elevated temperature to give the disulfide, and carbon to give  $\text{TcC}$ . A technetium hydride of the composition  $\text{TcH}_{0.73}$  is formed at 300 °C under a hydrogen pressure of ca. 0.2 GPa.

Only a few compounds have been prepared so far, with Tc in low oxidation states, including:

Tc(-1):  $\text{HTc}(\text{CO})_5$   
Tc(0):  $\text{Tc}_2(\text{CO})_{10}$ ,  $\text{CoTc}(\text{CO})_9$   
Tc(+1):  $\text{K}_2\text{Tc}(\text{CN})_6$ ,  $(\text{C}_6\text{H}_5)_2\text{TcH}$ ,  $\text{Tc}(\text{CO})_5\text{Cl}$   
Tc(+2):  $[(\text{C}_6\text{H}_5)_2\text{Tc}]_2$   
Tc(+3):  $[\text{Tc}(o\text{-phenylene-bis-dimethylarsine})_2\text{Cl}_2]\text{Cl}$   
Tc(+4):  $\text{TcO}_2$ ,  $\text{M}_2\text{TcX}_6$  (X = F, Cl, Br, I, SCN)

Oxidation of technetium metal by oxygen at 500 °C yields pale yellow  $\text{Tc}_2\text{O}_7$  (*mp* 119.5 °C, *bp* 310.6 °C) which reacts with water vapor to form dark red  $\text{HTcO}_4$ . Many pertechnetates such as  $\text{LiTcO}_4$  or the sparingly soluble  $\text{CsTcO}_4$  have been prepared and characterized.

Reduction of Tc(VII) solutions or thermal decomposition of  $\text{NH}_4\text{TcO}_4$  at 450 °C in vacuum gives  $\text{TcO}_2$  which has a distorted rutile structure. Brown-black  $\text{Tc}_2\text{S}_7$  is precipitated from  $\text{TcO}_4^-$  solution by gaseous  $\text{H}_2\text{S}$ .

**Uses.** Technetium itself and some of its compounds and ions have properties that should make them suitable for broad industrial applications. However, their inherent radioactivity prevents their general use except in special applications, for example, <sup>99m</sup>Tc in nuclear medicine.

Metallic technetium supported on  $\text{Al}_2\text{O}_3$  or  $\text{SiO}_2$  is an excellent catalyst for hydrogenation, dehydrogenation, dehydrocyclization, and cracking reactions, particularly of *C*<sub>6</sub> and *C*<sub>7</sub> species. The reforming of naphtha to gasoline with higher aromatic content is catalyzed by technetium-promoted  $\text{Cr}_2\text{O}_3$  catalysts, at a lower reaction temperature than other promoted catalysts. Technetium can, therefore, partly substitute for expensive platinum catalysts, especially as technetium catalysts are highly resistant to sulfur poisoning.

Metallic technetium is a weak-coupling type II superconductor with a high critical temperature (*T<sub>c</sub>* = 7.73 K). Some technetium

alloys have still higher critical temperatures up to *T<sub>c</sub>* ≈ 15.0 K for a technetium molybdenum alloy with 60 atom% technetium.

$\text{TcO}_4^-$  ions are excellent corrosion inhibitors even in the presence of corrosive media and at temperatures ≤ 250 °C. At pH ≈ 6 and 10 ppm Cl, a solution of 50 ppm technetium (≈ 5 × 10<sup>-4</sup> M Tc) suppresses corrosion of a 0.1% carbon steel even after 20 years. The corrosion rate is at least four orders of magnitude less than in the absence of  $\text{TcO}_4^-$  ions. The surface concentration of technetium on the steel corresponds to about a tenth of a monolayer. Furthermore, technetium-coated stainless steel does not corrode in seawater.

<sup>99</sup>Tc is used very often as a standard source of β radiation for radiometry and dosimetry. Such sources are safe and convenient to handle because of the lack of γ radiation.

In nuclear medicine, chemical compounds of <sup>99m</sup>Tc are widely used for radionuclidic imaging of the brain, liver, lung, and skeleton, and to a lesser extent in thyroid scintigraphy. <sup>99m</sup>Tc-labeled radiopharmaceuticals have been developed that are suitable for both static and dynamic evaluation of renal and cardiac pathology. Sales of <sup>99m</sup>Tc-labeled products account for about 75% of the total sale of radiopharmaceuticals in the United States; similar trends are observed in Europe.

**Handling.** <sup>99</sup>Tc is a soft β emitter so no special radiation protection measures are necessary. Tight glove boxes must be used to avoid contamination of work places and incorporation when handling powdered samples of <sup>99</sup>Tc compounds. Lead shielding is necessary for <sup>99</sup>Mo/Tc generators because <sup>99</sup>Mo also emits γ rays.

#### 40.4.3 Polonium

Element 84 was discovered in 1894 by P. and M. CURIE. Its discovery was possible because of its inherent radioactivity.

Today, all isotopes between mass numbers *M* = 193 and *M* = 218 are known including many relatively long-lived isomers. The longest-lived isotope <sup>209</sup>Po (*t*<sub>1/2</sub> = 102 a) is only available through charged-particle nuclear re-

actions and therefore not produced in weighable amounts. Nearly all the chemical and physical studies on polonium were performed with the pure α emitter <sup>210</sup>Po (*t*<sub>1/2</sub> = 138 d).

Even though polonium was first discovered by the separation of <sup>210</sup>Po from uranium ores, due to the very small amount of <sup>210</sup>Po (equilibrium concentration 7.4 × 10<sup>-11</sup> g <sup>210</sup>Po/g <sup>238</sup>U) in ores, nowadays most <sup>210</sup>Po is isolated in a different way. It is either separated from "old" radium samples or more recently by irradiation of very pure bismuth with neutrons in a nuclear reactor, even if the neutron capture cross section σ is low:

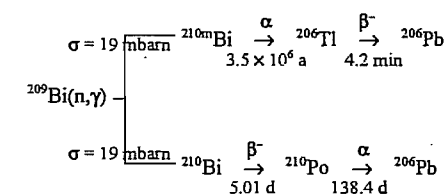

One year of irradiation of 1 kg bismuth at a neutron flux of 10<sup>14</sup> ncm<sup>-2</sup>s<sup>-1</sup> gives 25 mg <sup>210</sup>Po (ca. 4 × 10<sup>12</sup> Bq). The isolation of such quantities from natural sources is practically impossible. Following irradiation of bismuth, <sup>210</sup>Po is separated from molten bismuth by vacuum distillation. Final purification of polonium generally is accomplished by its spontaneous deposition on silver or copper powders. *Metallic polonium* is then easily prepared by sublimation of this deposit at about 700 °C. It is also obtained by reduction of polonium sulfide with hydrogen at 500 °C. Polonium sulfide itself is precipitated from an acid solution of polonium ion by gaseous  $\text{H}_2\text{S}$ .

Polonium with electronic configuration [Xe]  $4f^{14} 5d^{10} 6s^2 p^4$  is the heavy homologue to tellurium. The oxidation states 2-, 2+, 4+, and 6+ are known, but Po(IV) (ionic radius 102 pm) is the most stable one. Po(VI) (ionic radius 67 pm) is easily reduced to a lower oxidation state by its own radiation.

Important *physical properties* of polonium metal are:

<i>fp</i>	≈ 250 °C
<i>bp</i>	962 °C
Atomic radius	164 pm

Vapor pressure (438–745 °C), Pa	$\log p = (964.36 \pm 0.9064) - (716.860 \pm 893)/T(^{\circ}\text{C})$
Structure $\alpha$ Po (< 18 °C) $\beta$ Po (> 54 °C)	cubic, $a = 335.9$ pm thombohedral, $a = 336.9$ pm, $\alpha = 98.23^{\circ}$
Density $\alpha$ Po $\beta$ Po	9.142 g/cm <sup>3</sup> 9.352

**Chemical Properties.** Polonium is soluble in HCl and forms Po(II), in HNO<sub>3</sub> and aqua regia Po(IV) is produced.

Po(VI) solutions are obtained by the oxidation of Po(IV) with Cl<sub>2</sub>, K<sub>2</sub>Cr<sub>2</sub>O<sub>7</sub>, or Ce(IV)–HNO<sub>3</sub>, SO<sub>2</sub> and N<sub>2</sub>H<sub>4</sub> reduce Po(IV) to Po(II), by reduction with SnCl<sub>2</sub>, Ti(III), and NaHSO<sub>3</sub>, a precipitate of finely divided metallic polonium is formed.

**Compounds.** Polonides of several metals with the composition MPo (e.g., M = Mg, Mn, Y, rare earth element) are prepared by the interaction of polonium vapor with powdered metals. Most of these polonides dissociate at ca. 700 °C, only rare earth polonides are stable up to 1000 °C.

Polonium monoxide, PoO, is obtained by thermal decomposition of polonium selenide. The more stable PoO<sub>2</sub> is formed by thermal decomposition of, for example, PoO(OH)<sub>2</sub> or Po(IV) nitrate, or by reaction of metallic polonium and oxygen. It can be sublimed in an oxygen stream at 885 °C but decomposes in vacuum at 500 °C. PoO<sub>2</sub> vapor reacts with rare earth oxides to form compounds such as Pr<sub>2</sub>O<sub>3</sub>·PoO<sub>2</sub> and Dy<sub>2</sub>O<sub>3</sub>·PoO<sub>2</sub>.

Halides such as PoCl<sub>4</sub> and PoBr<sub>4</sub> are formed when polonium metal reacts with chlorine or bromine at ca. 100 °C. At 200 °C these halides decompose to the corresponding polonium dihalides. Complex halides such as M<sub>2</sub>PoX<sub>6</sub> (M = K, Rb, Cs; X = Cl, Br, I) of Po(IV) and MPoCl<sub>3</sub> and M<sub>2</sub>PoCl<sub>4</sub> of Po(II) are also known.

Due to the high radioactivity of <sup>210</sup>Po, relatively unstable compounds such as PoH<sub>2</sub>, PoF<sub>6</sub>, PoO<sub>3</sub>, and organometallic compounds could be identified only in tracer amounts but not in quantities that are needed for detailed investigations of their properties.

In aqueous solution, polonium ions are easily hydrolyzed even at pH = 1, if not complexed by, for example, oxalic, citric, or tartaric acids. Po(IV) in particular, is readily extracted from aqueous solutions by, e.g., tri-*n*-butyl phosphate, dithizone–CHCl<sub>3</sub>, and amines. Polonium is adsorbed as complex ions by anion exchangers in strong acid solution—elution must be performed rapidly due to the fast decomposition of the ion exchanger by  $\alpha$  activity.

**Uses.** <sup>210</sup>Po is the only isotope that finds broad application. It is used as an energy source for radioisotope batteries. This isotope has the advantage that it does not emit  $\gamma$  rays therefore heavy weight shielding of the batteries can be avoided. The disadvantage is the short half-life of <sup>210</sup>Po. <sup>210</sup>Po (140 W<sub>th</sub>/g) was especially used as an energy source in Soviet space missions, e.g., in Lunochod-1 and Lunochod-2. About 10<sup>15</sup> Bq <sup>210</sup>Po are needed for a radioisotope battery that delivers 1 kW electric power. The polonium is mostly provided in the form of rare earth polonides.

<sup>210</sup>Po is used also as an  $\alpha$  emitter for ( $\alpha$ , n) neutron sources. A BeO–<sup>210</sup>Po source emits up to 93 neutrons per 10<sup>6</sup>  $\alpha$  particles.

**Handling.** Tracer amounts of <sup>210</sup>Po can be handled in well-working fume hoods but even microgram quantities of <sup>210</sup>Po require handling in tight glove boxes due to unavoidable  $\alpha$  recoil and the consequent contamination of the working area.

#### 40.4.4 Francium

Element 87 is the most unstable of all naturally occurring elements. It was discovered in 1939 by M. PEREY. <sup>223</sup>Fr ( $t_{1/2} = 21.8$  min) is the most stable of all 27 isotopes.

Relatively pure <sup>223</sup>Fr solutions are obtained by its elution with NH<sub>4</sub>Cl–CrO<sub>3</sub> from a cation exchanger loaded with <sup>227</sup>Ac. The solution is further purified by passing it through a SiO<sub>2</sub> column loaded with BaSO<sub>4</sub>.

Francium is only monovalent and shows a very similar behavior to the other heavy alkali

elements. Francium has the most negative standard potential of all elements.

No industrial applications or uses in nuclear medicine have yet been found.

#### 40.4.5 Radium and Radon

**Radium** ( $Z = 88$ ) was discovered in 1898 by P. and M. CURIE and G. BÉMONT. <sup>226</sup>Ra ( $t_{1/2} = 1600$  a) is the longest-lived of all the 25 radium isotopes known to date. Its concentration in uranium ores is 0.36  $\mu\text{g}$  per gram uranium. <sup>223</sup>Ra, <sup>224</sup>Ra, and <sup>228</sup>Ra also occur in nature.

According to its electronic configuration [Rn] 7s<sup>2</sup>, radium shows the typical behavior of an alkaline earth element with a large ionic radius. It is obtained from uranium ores by a mixed precipitation–ion exchange procedure.

*Radium metal* is prepared by reduction of the oxide by aluminum at 1200 °C in vacuum. The pure metal has a cubic body-centered structure ( $a = 515$  pm) such as barium and a *mp* of 700 °C. The known compounds, including the halides RaX<sub>2</sub> (X = F, Cl, Br, I), the oxide RaO, the carbonate RaCO<sub>3</sub>, and the ternary oxides RaCeO<sub>3</sub> and RaMO<sub>4</sub> (M = Cr, Mo, W) are isostructural with corresponding barium compounds. Because of its large ionic radius, radium forms weak complexes and is not well extracted from aqueous solutions except at high pH values.

**Uses.** The use of <sup>226</sup>Ra as a  $\gamma$  emitter in nuclear medicine for cancer therapy lost its importance when larger and cheaper <sup>60</sup>Co sources became available. Also most ( $\alpha$ , n)-neutron sources based on <sup>226</sup>Ra were replaced by <sup>241</sup>Am–Be sources even if the number of emitted neutrons in <sup>226</sup>Ra sources are higher (for RaBeF<sub>4</sub>:  $1.84 \times 10^6$  neutrons per second and per gram <sup>226</sup>Ra).

Today radium is mainly used to prepare <sup>227</sup>Ac via neutron capture in a nuclear reactor.

**Handling.** <sup>226</sup>Ra requires special precautions to work with because it is considered the most toxic radioelement. Handling of <sup>226</sup>Ra is possible only in tight glove boxes where the circulating air stream must also be treated to avoid the escape of decay product <sup>222</sup>Rn to the envi-

ronment. Special care must be taken when opening disused radium ampoules because of possible overpressure formed by the decomposition of water.

**Radon**, the heaviest noble gas, was discovered in 1900 as a decay product of radium by F. E. DORN.

Today, radon isotopes with atomic masses between 199 and 226 are known, of which <sup>222</sup>Rn ( $t_{1/2} = 3.82$  d), <sup>220</sup>Rn ( $t_{1/2} = 55.6$  s), and <sup>219</sup>Rn ( $t_{1/2} = 3.96$  s) are members of natural decay series. On average, they contribute to about half of the natural radiation dose the population is exposed to.

Despite the fact that the chemical behavior of radon is only known from tracer experiments with the longest-lived <sup>222</sup>Rn, there is no doubt that radon is the most reactive noble gas. Reaction of radon with fluorine or halogen fluorides, such as BrF<sub>3</sub>, is likely to produce RnF<sub>2</sub> which can be reduced to radon by hydrogen only at temperatures > 500 °C. Radon fluoride can be sublimed at about 250 °C. It also seems to be possible to oxidize radon with O<sub>3</sub>.

There are no known uses of radon, except application of <sup>222</sup>Rn capsules for the treatment of cancer. The release of radon from solid substances (“emanation method” by O. HAHN) is often used to study structural changes of solids.

SbF<sub>5</sub> in the presence of ClF<sub>3</sub> and N<sub>2</sub>F<sub>2</sub>Sb<sub>2</sub>F<sub>11</sub> might be suitable for the removal of radon from the air in uranium mines in order to reduce radiation dose to workers by the formation of RnF.

#### 40.4.6 Actinium

The element with  $Z = 89$  was discovered in 1899 by A. DEBIERNE, but F. O. GIESEL in 1902 was the first to have prepared pure actinium. Of all 25 known isotopes, only the longest-lived <sup>227</sup>Ac ( $t_{1/2} = 21.77$  a) has some importance. In uranium ores its amount is too low to be recovered ( $2 \times 10^{-10}$  g per gram uranium), so currently nearly all <sup>227</sup>Ac is obtained by irradiation of <sup>226</sup>Ra. Three months irradiation at a neutron flux of  $5 \times 10^{14}$  ncm<sup>-2</sup>s<sup>-1</sup> transforms

2% of  $^{226}\text{Ra}$  to  $^{227}\text{Ac}$ . In the 1970s, about 18 g  $^{227}\text{Ac}_2\text{O}_3$  were prepared by this method. The  $^{227}\text{Ac}$  obtained was separated from  $^{226}\text{Ra}$  and decay products by a precipitation ion exchange process.

Because of its electronic configuration [Rn]  $6d^1 7s^2$  and ionic radius ( $r = 111$  pm for  $\text{Ac}^{3+}$ ), actinium closely resembles lanthanum, but only few compounds [e.g., the oxide  $\text{Ac}_2\text{O}_3$ , the sulfide  $\text{Ac}_2\text{S}_3$ , the phosphate  $\text{AcPO}_4 \cdot 0.5\text{H}_2\text{O}$ , the halides  $\text{AcX}_3$ , and oxide halides  $\text{AcOX}$  ( $X = \text{F}, \text{Cl}, \text{Br}, \text{I}$ )] have been synthesized up to now.

*Actinium metal* is obtained by reduction of  $\text{Ac}_2\text{O}_3$  with thorium at  $1750^\circ\text{C}$  and  $10^{-4}$  Pa. It crystallizes in the cubic  $\beta$ -lanthanum type structure with a lattice constant of  $a = 531.5$  pm. In solution only  $\text{Ac}^{3+}$  occurs. The stability of  $\text{Ac}^{3+}$  complexes is low due to the large ionic radius. Because of this, actinium can only be extracted from aqueous solutions at relatively high pH values with low distribution coefficients. Most solution experiments were performed by using  $^{228}\text{Ac}$  ( $t_{1/2} = 6.13$  h), separated from  $^{223}\text{Ra}$  ( $t_{1/2} = 5.7$  a).

**Uses.**  $^{227}\text{Ac}$  is a radionuclide with high specific power ( $14.3 \text{ W}_{\text{th}}/\text{g}$ ) and besides  $^{244}\text{Cm}$ , is the only radioisotope used for thermionic transformation of the heat of decay into electricity. For a thermionic battery that transforms 12% of heat into electricity, about 17 g  $^{227}\text{Ac}_2\text{O}_3$  (equivalent to about  $5 \times 10^{13}$  Bq) are needed to obtain  $250 \text{ W}_{\text{th}}$ . Due to the instability of thermionic batteries compared to thermoelectric devices, the interest in  $^{227}\text{Ac}$  is currently decreasing.

**Handling.** Handling of  $^{227}\text{Ac}$  is possible only in tight glove boxes, gram-amounts require hot cells with  $\gamma$  shielding. Well-aerated fume hoods are sufficient for the handling of trace quantities of all actinium isotopes.

#### 40.4.7 Protactinium

The element with  $Z = 91$  was discovered in 1913. K. FAJANS and O. GÖHRING were probably the first to have separated pure protactinium.

$^{231}\text{Pa}$  ( $t_{1/2} = 32\,480$  a) is the most important of all 24 known isotopes, even though  $^{233}\text{Pa}$  is of special importance because it is formed as an intermediate in the production of fissile  $^{233}\text{U}$  from nonfissile  $^{232}\text{Th}$  by neutron capture

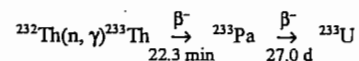

$$\sigma = 7.4 \text{ barn}$$

This process is used in thorium high temperature reactors (THTR), which utilize the fivefold occurrence of thorium in nature compared to uranium.

The separation of  $^{231}\text{Pa}$  from residues of uranium production is a difficult process. Nevertheless, around 1960 ca. 100 g pure  $^{231}\text{Pa}_2\text{O}_5$  were isolated from residues of the uranium production at Springfield, United Kingdom, that contained 3.7 ppm  $^{231}\text{Pa}$ . In future, larger quantities of  $^{231}\text{Pa}$  might be recovered from nuclear waste originating from reprocessing of thorium fuels, because it is formed via

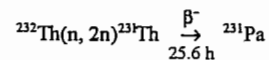

by the fast neutrons in a THTR nuclear reactor.

With its electronic configuration [Rn]  $5f^6 6d^1 7s^2$ , protactinium is the first element to possess 5f electrons in the ground state. Both in the solid state and in solution protactinium can occur in the oxidation state  $\text{Pa}^{4+}$  ( $r = 96$  pm) and  $\text{Pa}^{5+}$  ( $r = 90$  pm). In its chemical and physical behavior protactinium is much more similar to tantalum than to typical 5f elements.

*Protactinium metal* is best prepared by the Van Arkel method using a  $\text{PaC}-\text{I}_2$  mixture.  $\alpha$  Protactinium is tetragonal-body centered ( $a = 393.1$  pm,  $c = 323.6$  pm),  $\beta$  protactinium is cubic face-centered ( $a = 501.9$  pm). The melting point of protactinium is  $1572 \pm 20^\circ\text{C}$ .

**Compounds.** The solid state chemistry of protactinium is quite well known. Binary compounds exist such as the tetrahalides  $\text{PaX}_4$  and pentahalides  $\text{PaX}_5$  and complex compounds including the sparingly soluble  $\text{K}_2\text{PaF}_7$ . The very stable white  $\text{Pa}_2\text{O}_5$  occurs in at least five modifications. The reduction of  $\text{Pa}_2\text{O}_5$  with

pure hydrogen at  $1550^\circ\text{C}$  yields black  $\text{PaO}_2$ . A protactinium peroxide of still unknown composition can be precipitated from diluted acids. This method is used to separate protactinium from tantalum and niobium which form soluble peroxide complexes.

$\text{Pa(V)}$  is hydrolyzed in aqueous solution even in strong acids, if not complexed, for example, by  $\text{F}^-$  ions. No  $\text{Pa}^{5+}$  exists in solution. Only partly hydrolyzed species with two positive charges (in ca. 1 M HCl) or one positive charge (in  $10^{-3}$ – $10^{-1}$  M  $\text{H}^+$ ) could be identified.  $\text{Pa(V)}$  is readily adsorbed onto precipitates, surfaces (even metal surfaces), graphite, quartz, etc. The partly hydrolyzed protactinium species form very stable complexes with most organic ligands.  $\text{Pa(V)}$  can be extracted from aqueous solution by amines and most neutral and acid phosphoric and phosphonic extraction agents. The distribution coefficients are high.

$\text{Pa(IV)}$  solution is obtained by reduction of  $\text{Pa(V)}$  solutions using chemical (e.g., zinc) or electrochemical methods. The behavior of  $\text{Pa(IV)}$  is very similar to all other actinides of oxidation state IV, however, its tendency to hydrolyse is much higher.

Due to the unavoidable hydrolysis and formation of radiocolloids, solutions of protactinium in various oxidation states must be freshly prepared before use. The large number of unexplainable results found in the literature are mostly due to using degraded protactinium solutions with partly hydrolyzed, nonspecified protactinium species that change composition by time, even in 6 M HCl.

**Uses.** Protactinium plays an important role in the THTR fuel cycle, especially because of the high neutron absorption cross section of  $^{233}\text{Pa}$  ( $t_{1/2} = 27.0$  d) that lowers the amount of fissile  $^{233}\text{U}$  formed. Therefore, several processes, for example, for a "molten salt reactor", have been developed to separate protactinium continuously during reactor operation with the consequence that  $^{233}\text{Pa}$  will decay outside the reactor core and, therefore, not absorb neutrons. However, many technological prob-

lems have to be solved before practical application.

**Handling.**  $^{231}\text{Pa}$  must be handled in tight glove boxes, whereas tracer chemistry of protactinium (e.g., with  $^{233}\text{Pa}$ ) can be performed in well-aerated fume hoods.

### 40.5 The Biological Effects of Radiation and Radionuclides

The assessment of the health hazards arising from ionizing radiation has undergone a striking change in the course of this century. When RÖNTGEN announced in 1895 that he had discovered a new type of radiation, which he called X rays, the world reacted with an immense faith in progress. Although harmful side effects of X rays were soon encountered, no one thought about hazards or radiation protection. Inflammation similar to that caused by burns was observed on the hands of operators repeatedly testing X ray pictures and, later, the first cases of radiation-induced skin cancer became known. Only a decade after the discovery of X rays, an increased frequency of leukemia among radiologists was noticed [9]. This was not regarded as a warning sign but, at best, as an indication of the possible hazards arising from the long-term exposure to high doses of radiation.

The positive expectations that were aroused by this new agent are reflected in the application of X rays and natural radioactivity (which was discovered just a year later) in medicine within few weeks after the discovery by RÖNTGEN. X rays were being used extensively in the examination of the human body and first in simple medical diagnoses. Radioactivity was also quickly applied for all kinds of medical therapy and especially radium, with its penetrating  $\gamma$  radiation, was frequently and indiscriminately used at the start of this century in a large number of diseases and for the supposed stimulation of the organism. For instance, the application in the form of radium pillows was

common, even in the absence of disease and without medical supervision.

Early fundamental work in radiation biology, e.g., by the young FRIEDRICH DESSAUER [10], showed that higher doses of ionizing radiation destroy living cells. This finding quickly led to the introduction and subsequent improvement of radiation therapy for cancer patients. In spite of the accumulated results on the biological effects of ionizing radiation, the belief in the harmlessness of low doses of radiation persisted for decades.

The fate of hundreds of young women, especially in the United States, who painted the faces of clocks and instruments with luminous paint containing the long-lived,  $\alpha$ -emitting  $^{226}\text{Ra}$  was one of the first great tragedies resulting from unprotected exposure to radionuclides. Since they had not been warned of possible hazards, the workers sharpened their brushes soaked in luminous paint with their mouths, thus incorporating considerable amounts of activity. Many of them died of bone tumors [11, 12]. A young doctor published his suspicions, that the severe lesions in the jaws of the young women could be caused by radiation. In response, he was called a charlatan by a reader because, as was explained in the reader's letter, it was common knowledge that radiation was dangerous only in massive overdoses over long periods of time. The letter was written by the great scientist Marie Curie, who herself fell victim to radiation exposures later.

These and similar examples illustrate the consequences of the uncritical contact with ionizing radiation which took place in the first half of this century. A fundamental change in assessment of radiation hazards occurred, when the long-term effects of radiation exposure were discovered in the survivors of the atomic bombings of Hiroshima and Nagasaki. The possibility that leukemia might result from a single and relatively small dose of radiation was proposed by Lewis in the 1950s [13]. He inferred from the increased frequency of leukemia among the survivors of the atomic bombings—about a dozen cases per year—that leukemia could result from somatic muta-

tions, i.e., individual alteration in the DNA of single cells. This finding became the basis for the present philosophy of radiation protection, which holds the principle that unnecessary exposure to radiation should be prevented and unavoidable exposures should be reduced as far as possible.

The recognition that even the smallest doses of radiation can—with correspondingly low probability—cause hereditary defects or cancers and the fact that this possibility was recognized first for radiations, and only later for chemical carcinogens, may have led to the amazing change in the attitude to ionizing radiation. In the past, people had blind faith in the mysterious biopositive effects of radiation, but now the risks, which must indeed be taken seriously, are often overestimated in comparison with other risk factors.

**Physical Radiation Effects.** Several levels can be distinguished in the effects of ionizing radiation: physical, molecular, cellular, and tissue effects.

In spite of considerable differences in the energy transport and interactions with matter, all types of ionizing radiation act through the same physical primary processes and, as discussed later, they all act predominantly by damaging the DNA, i.e., the genetic material of the cell. *Indirectly ionizing radiation*, i.e., photons and neutrons, release fast particles in matter. The charged particles are, in turn, ionizing and produce secondary electrons which cause the major part of the ionizations and excitations. In the case of excitation, the excited molecule dissociates into radical or nonradical products or it gives up its energy to the environment without disintegrating. In comparison with ionizations, however, electron excitations are of secondary importance for radiation effects. In the case of *directly ionizing radiation*, such as electrons or  $\alpha$  particles, charged particles are present from the start.

The photons of X rays or  $\gamma$  rays generated in nuclear decay and energy-rich neutrons have substantial penetrating power in tissue. The high-energy electrons produced in an accelerator can also penetrate deeply into tissue.

In contrast the electrons of  $\beta$  radiation, which are produced in radioactive decay, have a range of only a few millimeters in tissue. For this reason,  $\beta$  emitters are active primarily when they are incorporated. The same applies to  $\alpha$  emitters. As a result of their short range, they are of importance only in the case of inhalation or ingestion of radionuclides.

Since the primary physical and chemical effects are identical for all types of ionizing radiation, the same quantity can be used to measure the extent of a radiation exposure. This quantity is called the *adsorbed dose*,  $D$ , or simply the dose. The unit used, to express the absorbed dose, is J/kg, or gray (Gy). In spite of the identity of the physical primary processes, the various types of radiation have, even at the same absorbed dose, different efficiency in the cell or tissue. The reason for the differences lies in the varying microscopic concentration of the energy transferred along the tracks of the various particles. *Sparsely ionizing radiations*, such as  $\gamma$  rays, X rays, or fast electrons, cause only a few dozen ionizations along their path through the cell. The resulting direct and indirect damage to DNA can be largely repaired. *Densely ionizing particles*, such as the relatively slow, heavy  $\alpha$  particles or recoil nuclei triggered by neutrons, cause thousands of ionizations as they pass through the cell. The clustered DNA damage produced within a small site can often be only imperfectly repaired. The difference between the various types of radiation is quantified by the linear energy transfer (LET), i.e., the rate of energy loss per unit distance.

In the application of ionizing radiation in *tumor therapy*, the different efficiency of the various types of radiation must be carefully evaluated. Moreover, the effect ratio depends in a complicated manner on the dose and the dose distribution in time. Simplified evaluations of radiation quality are adequate for the purpose of *radiation protection*, where low doses are involved and, furthermore, only summary estimates are required of effects that are possible, but less likely to occur.

Radiation protection summarily takes into account the different efficiency of densely and

sparsely ionizing radiation through the *quality factor*,  $Q$ . This factor represents the relative biological effectiveness of the different types of radiation with regard to the production, through DNA damage, of stochastic, long-term effects, i.e., hereditary damage or carcinogenesis. The International Commission for Radiation Protection (ICRP) has defined the quality factor as a function of the LET [14] (Figure 40.2). The *dose equivalent*,  $H$ , is the product of the absorbed dose,  $D$ , times the quality factor,  $Q$ :

$$H = D \times Q$$

To differentiate between the absorbed dose and the dose equivalent, the latter is expressed in the unit sievert (Sv).

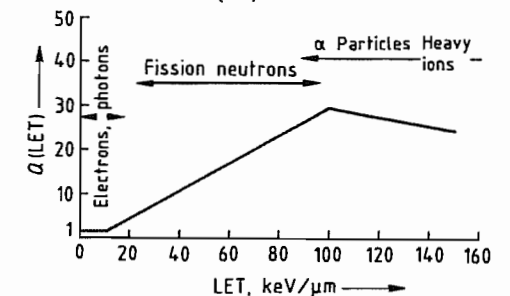

Figure 40.2: Quality factor as a function of the linear energy transfer, LET [14]. The corresponding ranges of LET are shown for some types of radiation.

## 40.6 References

1. *Gmelin*, 8th ed., Technetium, System no. 69, Suppl. vol. 1 and 2 (1982).
2. *Gmelin*, 8th ed., Polonium, System no. 12, Suppl. (1990).
3. *Gmelin*, 8th ed., Francium, System no. 25a, Suppl. (1983).
4. *Gmelin*, 8th ed., Radium, System no. 31, Suppl. vol. 1 and 2 (1977).
5. *Gmelin*, 8th ed., Actinium, System no. 40, Suppl. (1981).
6. *Gmelin*, 8th ed., Protactinium, System no. 51, Suppl. vol. 1 and 2 (1977).
7. E. J. Wheelwright: *Promethium Technology*, American Nuclear Society, Winsdale, IL, 1977.
8. F. Weigel, *Chem. Ztg.* **102** (1978) 287–299.
9. N. von Jagle, G. Schwarz, L. von Sienbenrock: "Blutbefunde bei Röntgenologen", *Berl. Klin. Wochenschr.* **48** (1911) 1220–1222.
10. F. Dessauer: "Über einige Wirkungen von Strahlen", *Z. Phys.* **12** (1922) 38.
11. H. S. Martland: "The Occurrence of Malignancy in Radioactive Persons: A General Review of Data

- Gathered in the Study of the Radium Dial Painters with Special Reference to the occurrence of osteogenic Sarcoma and the Interrelationship of Certain Blood Diseases", *Am. J. Cancer* 15 (1931) 2435-2516.
12. D. M. Taylor, C. W. Mays, G. B. Gerber, R. G. Thomas: "Risk from Radium and Thorotrast", *BIR Report* 21, EUR 12088, Brussels 1989.
13. E. B. Lewis: Leukemia and Ionizing Radiation", *Science (Washington, DC)* 125 (1957) 965-972.
14. International Commission on Radiological Protection, ICRP Publication 60. 1990 Recommendations of the International Commission on Radiological Protection, Pergamon Press, Oxford 1991.

## 41 Uranium

MARTIN PEEHS, SABINE WALTER, THOMAS WALTER

41.1 Introduction .....	1599	41.7.4.8 Complete Plant for Production of $UF_6$ from Uranyl Nitrate .....	1626
41.2 History .....	1600	41.7.4.9 Enrichment of $^{235}U$ .....	1627
41.3 Physical Properties .....	1601	41.7.4.10 Production of $UO_2$ Pellets from $UF_6$ .....	1631
41.3.1 Radioactivity .....	1601	41.7.4.11 Production of Uranium Metal .....	1635
41.3.2 Modifications .....	1601	41.8 Compounds .....	1637
41.3.3 Mechanical Properties .....	1604	41.8.1 Halides .....	1637
41.3.4 Thermal Properties .....	1604	41.8.1.1 Trivalent Halides .....	1637
41.3.5 Electrical and Electrochemical Properties .....	1605	41.8.1.2 Uranium Tetrahalides .....	1638
41.3.6 Magnetic Properties .....	1605	41.8.1.3 Uranium Pentafluoride .....	1638
41.4 Chemical Properties .....	1605	41.8.1.4 Uranium Hexafluoride .....	1638
41.5 Occurrence, Requirement, and Production Figures .....	1606	41.8.2 Carbides .....	1639
41.5.1 Occurrence .....	1606	41.8.3 Nitrides .....	1640
41.5.2 Resources, Requirement, and Production Figures .....	1607	41.8.4 Oxides .....	1640
41.6 Uses .....	1611	41.8.4.1 Uranium Dioxide .....	1640
41.7 Production .....	1612	41.8.4.2 Uranium Trioxide .....	1641
41.7.1 From Crude Ore to Yellow Cake ..	1612	41.8.4.3 Triuranium Octaoxide .....	1641
41.7.2 From Yellow Cake to $UF_6$ .....	1612	41.8.4.4 Peroxides .....	1642
41.7.3 From $UF_6$ to the Nuclear Fuel $UO_2$	1612	41.8.5 Nitrates .....	1642
41.7.4 Detailed Description of the Processes .....	1613	41.8.6 Sulfates .....	1643
41.7.4.1 Digestion and Leaching of Ores ..	1613	41.8.7 Tricarbonatodioxouranate .....	1643
41.7.4.2 Treatment of the Solution .....	1614	41.9 Safety .....	1643
41.7.4.3 Production of Uranium Concentrate .....	1617	41.9.1 Radiation Shielding .....	1643
41.7.4.4 Final Purification of Uranium Concentrate .....	1617	41.9.2 Safety Against Uncontrolled Criticality .....	1644
41.7.4.5 Production of $UO_3$ and $UO_2$ from Purified Uranyl Nitrate Solution ..	1619	41.9.3 Geometrically Safe Vessels .....	1644
41.7.4.6 Production of $UF_4$ .....	1623	41.9.4 Apparatus with Heterogeneous Neutron Absorbers .....	1645
41.7.4.7 Production of $UF_6$ from $UF_4$ .....	1625	41.9.5 Neutron Interactions in the $UO_2$ Fabrication Plant .....	1645
		41.9.6 Transportation .....	1645
		41.10 References .....	1646

The following abbreviations are used:

ADU	ammonium diuranate
AUC	ammonium uranyl carbonate
AVLIS	Atomic Vapor Laser Isotope Separation
BNFL	British Nuclear Fuels Limited
DC	Direct Conversion
GECO	General Electric Dry Conversion
DEHPA	2-ethylhexyl phosphate
IDR	Integrated Dry Route
LWR	light-water reactor
MLIS	Molecular Laser Isotope Separation
MTR	materials testing reactor
RIP	resin in pulp
TBP	tributyl phosphate
TOPO	trioctylphosphine oxide
USW	uranium separative work

UTK uranium tetrafluoride in kilns

### 41.1 Introduction

Uranium, atomic number 92, is a radioactive element that is transformed into the stable element lead via many intermediate stages involving the emission of  $\alpha$ - and  $\beta$ -radiation. Uranium has the probable electronic configurations  $4s^2p^6d^{10}f^4$ ,  $5s^2p^6d^{10}$ ,  $6s^2p^6d^4$ , and  $7s^2$ , and is a member of the actinides in which the  $6d$  shell is filled until uranium is reached, and the  $5f$  shell is then filled from neptunium on-

ward to  $5f^4$ . Natural uranium consists of three isotopes whose concentrations in different resources are usually the same, even to the fourth decimal:  $^{238}\text{U}$ , 99.2762 at%;  $^{235}\text{U}$ , 0.7182 at%;  $^{234}\text{U}$ , 0.0056 at%. However, uranium from one deposit in Gabon (the Oklo mine) is exceptional [8], the proportion of  $^{235}\text{U}$  being lower (see below [9]):

Expected $^{235}\text{U}$ content	0.711 %
Measured $^{235}\text{U}$ content (July 7, 1972)	0.7078 %
Absolute discrepancy	0.0032 %
Relative discrepancy	0.45 %
Accuracy of measurement	$\pm 0.0001$ %

The somewhat lower percentage of  $^{235}\text{U}$  in the Oklo deposit led to the discovery of natural reactors and the revelation that the first nuclear fission chain reaction was not brought about by humans in 1942 but by nature long before this. Since its discovery, the Oklo phenomenon has been investigated in great detail, and the results are documented in almost 100 papers. At least ten different reactor zones have been identified in Oklo. The individual reactors were active for 100 000 to 800 000 years. These periods of activity, which occurred  $1.8 \times 10^9$  years ago, resulted in the release of  $100 \times 10^9$  kWh thermal energy, equaling the output of a large-capacity power reactor over a three-year period. These natural reactors are the only ones discovered thus far in the world. During these periods of activity, natural uranium still had a  $^{235}\text{U}$  content of ca. 3%; geochemical processes caused the U content to increase to 30% and higher. The thickness of the natural deposits reached 50 cm, and the presence of water as a moderator and coolant caused the configuration to become critical. The nuclear fission that then occurred was controlled by the properties of water. High power output led to evaporation of water, with consequent reduction of the moderating effect; lower power led to condensation and increased moderation. Decay products from earlier fission products and from the plutonium formed in the active zones of the natural Oklo reactor are still present without losses. This shows that these elements have not been dispersed but have been immobilized by simple geological barriers.

## 41.2 History

Uranium was discovered in 1789 by MARTIN HEINRICH KLAPROTH, who extracted it from pitchblende. He precipitated the yellow uranate and reduced this with charcoal, but obtained only a black oxide, probably  $\text{UO}_2$ . In 1790, he named the putative metal uranium after the planet Uranus, which had been discovered in 1781 by HERSCHEL. In 1841, E. M. PÉLIGOT reported that he had obtained uranium metal by thermal reduction of anhydrous uranium tetrachloride with potassium in a platinum crucible. In 1856, he succeeded in producing the pure metal in compact form by reducing uranium tetrachloride with sodium with complete exclusion of air. A worth mentioning quantity of uranium metal was put on display at the Paris World Exhibition of 1867.

In the 1890s, H. MOISSAN developed new processes for producing metallic uranium. He obtained the purest metal (> 99% uranium) by electrolysis of sodium uranyl chloride. At the end of the 19th century, uranium found some almost unnoticed industrial applications, e.g., in glass and ceramics because of the beautiful colors of its different compounds.

The discovery of radioactivity by A. H. BECQUEREL on March 1, 1896, resulted from experiments with uranium. The fluorescence and phosphorescence of uranium compounds had been studied from about the mid-1800s. Following the discovery of X rays, the question arose of whether substances showing strong fluorescence or phosphorescence emitted penetrating rays of a similar kind. BECQUEREL exposed potassium uranyl sulfate to sunlight and observed that it emitted rays that darkened photographic plates. An interruption of these investigations due to cloud cover led to the discovery of intense darkening of the plates by uranium salts that had not been exposed to light. He concluded from this that uranium salts produced a special kind of radiation independent of light exposure.

The history of uranium is closely linked to the discovery of polonium and radium in pitchblende by P. and M. CURIE in 1898. The induced fission of the isotope  $^{235}\text{U}$  was discov-

ered in 1938 by O. HAHN and F. STRASSMANN. This discovery was followed by intense research activity, that led to the first man-made nuclear chain reaction, which was brought about in Chicago by E. FERMI on December 2, 1942. World War II and U.S. decision to have a nuclear weapon led to intense activity in uranium research and nuclear development. Uranium enrichment plant based on the electromagnetic process was started in 1943 in Oak Ridge, Tennessee, followed a year later by another plant based on the gas diffusion principle.

After World War II, the search for uranium ores for the peaceful utilization of nuclear energy was intensified in most countries, and some large deposits were discovered. In the 1960s, military applications predominated; the peaceful use of nuclear energy gradually gained in importance in the late 1970s. Enriched uranium was required for the light-water reactors favored for energy production; thus, enrichment processes and techniques to manufacture fuel elements became important research and development topics. Enrichment by gas diffusion processes was used in the United States and France, whereas Germany, The Netherlands, and the United Kingdom developed a cooperative program based on three enrichment plants using the ultracentrifuge principle. The jet nozzle separation process, developed in Germany, is used in a demonstration plant in Brazil and South Africa.

Literature searches carried out for the present article have revealed that research and development of nuclear energy production and related technologies were largely complete in Western societies by the early 1980s. However, research continued into the technology of enrichment (laser and chemical processes), along with fundamental research into the band structure of uranium.

## 41.3 Physical Properties

### 41.3.1 Radioactivity

The natural uranium isotopes ( $^{238}\text{U}$ ,  $^{235}\text{U}$ ,  $^{234}\text{U}$ ) are  $\alpha$ -emitters. Tables 41.1 and 41.2 show the decay chains of the two most important isotopes. These chains terminate with the nonradioactive isotopes  $^{206}\text{Pb}$  and  $^{207}\text{Pb}$ .

Artificial uranium isotopes are formed in a nuclear reactor (e.g., by irradiation or decay of transuranics). Thus, after reprocessing of spent fuel elements, the following uranium isotopes are found in the purified uranium for a uranium burnup of 36 GW·d/t and an initial enrichment in the fuel elements of 3.5%:

$^{232}\text{U}$ :	concentration 0.71 mg per tonne U; half-life 74 a; $\rightarrow$ $^{228}\text{Th}$
$^{233}\text{U}$ :	concentration 7.4 mg per tonne U; half-life 1.6 $\times 10^5$ a; $\rightarrow$ $^{229}\text{Th}$
$^{234}\text{U}$ :	concentration 137 g per tonne U; half-life 2.5 $\times 10^5$ a; $\rightarrow$ $^{230}\text{Th}$
$^{236}\text{U}$ :	concentration 4490 g per tonne U; half-life 2.4 $\times 10^7$ a; $\rightarrow$ $^{232}\text{Th}$

All four artificial isotopes are  $\alpha$ -emitters with a certain amount of  $\gamma$ -emission and are transformed into the thorium isotopes indicated. Because of the comparatively short half-life of  $^{232}\text{U}$ , associated  $\gamma$ -emission requires heavily shielded equipment for radiation protection. This hot-cell technology is also needed to handle the radioactive fission products in the reprocessing of spent fuel. Because it has an odd atomic number,  $^{233}\text{U}$  is fissile by capture of a thermal neutron when it is reused in the reactor. However,  $^{236}\text{U}$  in particular is purely a neutron absorber, so that on use of the reprocessed uranium, the fissile fraction ( $^{235}\text{U}$ ) must be increased by ca. 0.15% to compensate for neutron capture by the 0.45%  $^{236}\text{U}$ .

### 41.3.2 Modifications

The phase diagram of uranium is shown in Figure 41.1 [10, 11]. At atmospheric pressure, uranium occurs in three modifications with different crystal structures, depending on temperature [12]:

$\alpha$ -Uranium,  $T < 942$  K, orthorhombic  
Lattice constants:  $a = 0.2858$  nm,  $b = 0.5876$  nm,  $c =$

0.4955 nm at 298.15 K.

$\beta$ -Uranium,  $T = 942\text{--}1049$  K, tetragonal  
Lattice constants:  $a = 1.0759$  nm,  $c = 0.5656$  nm at 942 K (lower transformation point).

$\gamma$ -Uranium,  $T = 1049\text{--}1408$  K, body-centered cubic  
Lattice constants:  $a = 0.3524$  nm at 1049 K (lower transformation point).

The triple point of the three modifications is at  $3.6 \pm 0.2$  GPa and  $1078 \pm 3$  K [10]. Figures quoted for the  $mp$  at atmospheric pressure

cover the relatively narrow range between 1398 K (1125 °C) [13] and 1408 K (1135 °C) [14]. These small discrepancies are due to extremely low levels of impurities that cannot be avoided completely. The  $bp$  is said to be 4407 K. The theoretical density of  $\alpha$ -uranium is  $19.13$  g/cm<sup>3</sup>, small variations in the experimental value again being due to impurities.

Table 41.1: Radioactive decay of <sup>238</sup>U.

	Atomic number	Relative atomic mass	Penetration of $\alpha$ -particles in air at 15 °C and 0.1 MPa, cm	Half-life	Amount in radioactive equilibrium with <sup>238</sup> U contained in 1000 kg uranium, g
<sup>238</sup> U	92	238.05	2.63	$4.515 \times 10^9$ a	$9.93 \times 10^3$
$\alpha \downarrow$ <sup>234</sup> Th	90	234		24.10 d	$1.426 \times 10^{-5}$
$\beta \downarrow$ <sup>234</sup> Pa	91	234		1.16 min	$4.76 \times 10^{-10}$
$\beta \downarrow$ <sup>234m</sup> Pa	91	234		6.7 h	$2.5 \times 10^{-10}$
$\beta \downarrow$ <sup>234</sup> U	92	234	3.22	$2.32 \times 10^5$ a	50.1
$\alpha \downarrow$ <sup>230</sup> Th	90	230	3.13	$8.3 \times 10^4$ a	17.6
$\alpha \downarrow \gamma$ <sup>226</sup> Ra	88	226.03	3.30	1590 a	$3.32 \times 10^{-1}$
$\alpha \downarrow \gamma$ <sup>222</sup> Rn	86	222	4.06	3.825 d	$2.147 \times 10^{-6}$
$\alpha \downarrow$ <sup>218</sup> Po	84	218	4.67	3.05 min	$1.17 \times 10^{-9}$
$\alpha \downarrow$ <sup>214</sup> Pb	82	214		26.8 min	$1.01 \times 10^{-8}$
$\beta \downarrow \gamma$ <sup>214</sup> Bi	83	214	4.1	19.7 min	$7.4 \times 10^{-9}$
$\beta \downarrow \gamma$ <sup>214</sup> Po	84	214	6.95	$1.45 \times 10^{-4}$ s	$9.1 \times 10^{-16}$
$\alpha \downarrow$ <sup>210</sup> Tl	81	210		1.32 min	$1.95 \times 10^{-13}$
$\beta \downarrow \gamma$ <sup>210</sup> Pb	82	210		22.3 a	$4.32 \times 10^{-3}$
$\beta \downarrow \gamma$ <sup>210</sup> Bi	83	210		4.95 d	$2.63 \times 10^{-6}$
$\beta \downarrow \gamma$ <sup>210</sup> Po	84	210	3.85	138.8 d	$7.37 \times 10^{-5}$
$\alpha \downarrow \gamma$ <sup>206</sup> Tl	81	206		4.23 min	$7.6 \times 10^{-16}$
$\beta \downarrow$ <sup>206</sup> Pb	82	205.97		stable	$\infty$

\*99.96%.

Table 41.2: Radioactive decay of <sup>235</sup>U.

	Atomic number	Relative atomic mass	Penetration of $\alpha$ -particles in air at 15 °C and 0.1 MPa, cm	Half-life	Amount
<sup>235</sup> U	92	235.04	2.7	$7.07 \times 10^8$ a	$7.06 \times 10^3$
$\alpha \downarrow$ <sup>231</sup> Th	90	231		24.6 h	$2.75 \times 10^{-8}$
$\beta \downarrow$ <sup>231</sup> Pa	91	231.04	3.62	$3.2 \times 10^4$ a	$3.14 \times 10^{-1}$
$\alpha \downarrow$ <sup>227</sup> Ac	89	227		21.7 a	$2.09 \times 10^{-4}$
$\beta \downarrow$ <sup>227</sup> Tl	90	227	4.67	18.6 d	$4.85 \times 10^{-7}$
$\alpha \downarrow$ <sup>223</sup> Ra	88	223	4.33	11.3 d	$2.93 \times 10^{-7}$
$\alpha \downarrow$ <sup>219</sup> Rn	86	219	5.75	3.92 s	$1.16 \times 10^{-12}$
$\alpha \downarrow$ <sup>215</sup> Po	84	215	6.49	0.00183 s	$5.30 \times 10^{-16}$
$\alpha \downarrow$ <sup>211</sup> Pb	82	211		36.1 min	$6.15 \times 10^{-10}$
$\beta \downarrow \gamma$ <sup>211</sup> Bi	83	211	5.46	2.16 min	$3.68 \times 10^{-11}$
$\beta \downarrow$ <sup>211</sup> Po	84	211	6.59	ca. 0.005 s	$4.5 \times 10^{-18}$
$\alpha \downarrow$ <sup>207</sup> Pb	82	206.98		stable	$\infty$

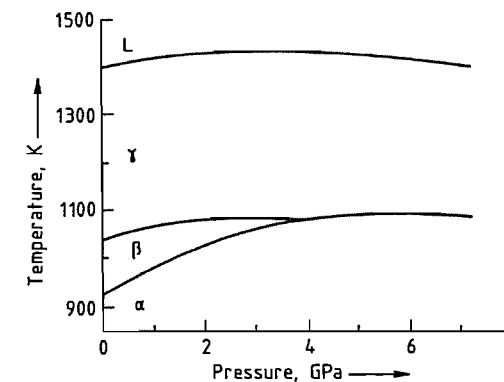

Figure 41.1: Phase diagram of uranium [10, 11]. Ranges of the  $\alpha$ -,  $\beta$ -, and  $\gamma$ -modifications and of the liquid are shown.

Table 41.3: Mechanical strength of rolled uranium metal products annealed in the  $\alpha$ - or  $\beta$ -region before measurement [15].

	Test temperature, °C	0.2% yield strength, MPa	Ultimate tensile strength, MPa	Elongation, %
Rolled at 570 °C	$\alpha$ -annealed	298.6	766.0	6.8
	$\beta$ -annealed	169.3	439.9	8.5
Rolled at 1110 °C	$\alpha$ -annealed	179.3	609.5	13.5
	$\beta$ -annealed	169.6	425.4	6.0
Rolled at 570 °C, $\alpha$ -annealed	299	120.7	242.7	49.0
	299	129.6	217.7	43.0
Rolled at 570 °C, $\alpha$ -annealed	499	35.2	76.7	61.0
	499	37.6	72.0	57.0



**Table 41.4:** Hardness of annealed uranium metal.

Annealed for 1 h at	Rockwell hardness		Brinell hardness number
	150-kg weight	100-kg weight	
310 °C	36.6	109	341
490 °C	24.0	101	247
600 °C	22.0	99	240
720 °C	9.0	90	185
770 °C	0	92	152

### 41.3.3 Mechanical Properties

In the  $\gamma$ -phase (1049 K < T < 1408 K), the metal is soft, ductile, and easily worked. However, since this phase is readily oxidized in an oxidizing environment (e.g., air), uranium usually must be worked while in the  $\alpha$ -phase at lower temperature (at 563 K).

Mechanical strength data for the  $\alpha$ - and  $\beta$ -phases are given in Table 41.3 [15].

The hardness of the metal depends strongly on the annealing temperature (Table 41.4). The Rockwell hardness was measured at applied weights of 100 and 150 kg, and the Brinell hardness is given in Brinell numbers (applied weight of 300 kg divided by the penetration area of a 10-mm steel sphere).

The modulus of elasticity is also very dependent on the history of the material; it ranges between 155 GPa ( $\alpha$ -phase, rolled;  $\beta$ -phase, annealed) and 207 GPa ( $\gamma$ -phase, extruded).

### 41.3.4 Thermal Properties

The specific and molar heat capacities of the three uranium modifications are given in Table 41.5 [12].

**Table 41.5:** Specific and molar heat capacities of uranium modifications.

	$c_p, \text{Jkg}^{-1}\text{K}^{-1}$	$C_p, \text{Jmol}^{-1}\text{K}^{-1}$
$\alpha$ -Uranium (298.15 K)	116	27.666
$\beta$ -Uranium (942 K)	180	42.928
$\gamma$ -Uranium (1049 K)	161	38.284

In the  $\alpha$ - and  $\beta$ -phases, uranium is anisotropic; i.e., thermal expansion depends on direction. Thus, a crystal of  $\alpha$ -uranium expands in only two directions and contracts in the third (Figure 41.2). The expansion coefficients for

$\alpha$ -uranium in the various crystal directions are given in Figure 41.3 [16, 17].

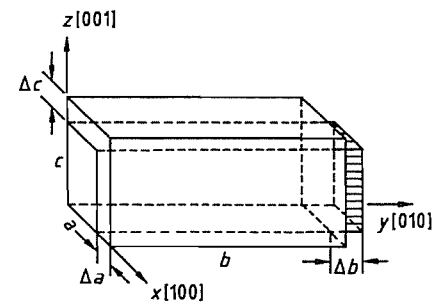
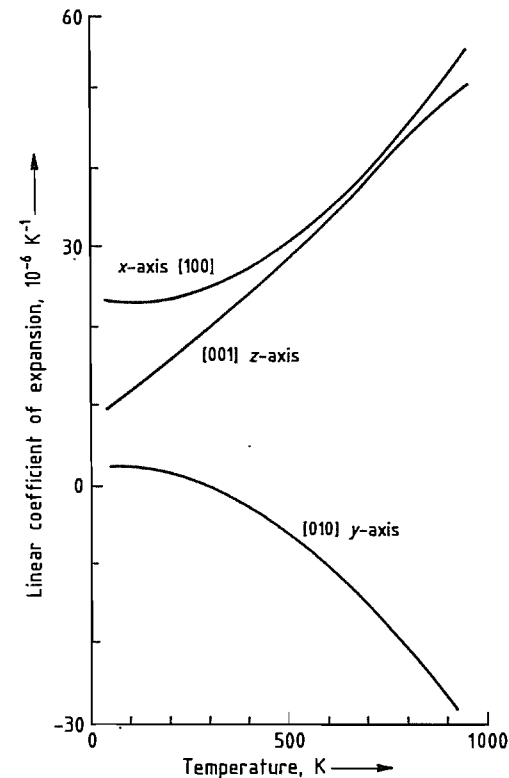
**Figure 41.2:** Dimensional change of  $\alpha$ -uranium from 0 to 300 °C. Original dimensions:  $a = 0.2832$  nm;  $b = 0.5985$  nm;  $c = 0.4945$  nm;  $\Delta a = +0.0015$  nm;  $\Delta b = -0.0006$  nm;  $\Delta c = +0.0339$  nm.**Figure 41.3:** Linear expansion coefficient of  $\alpha$ -uranium [16, 17].

For  $\beta$ -uranium in the range 959–998 K, the linear coefficients of expansion are

$z$ -axis,  $4.6 \times 10^{-6} \text{ K}^{-1}$   
 $x$ -axis,  $23.0 \times 10^{-6} \text{ K}^{-1}$

$y$ -axis,  $16.9 \times 10^{-6} \text{ K}^{-1}$

The linear coefficient of expansion of  $\gamma$ -uranium is the same for all three axes (i.e., ca.  $18 \times 10^{-6} \text{ K}^{-1}$ ).

The thermal conductivity of uranium at 298 K is  $27.60 \text{ Wm}^{-1}\text{K}^{-1}$ .

### 41.3.5 Electrical and Electrochemical Properties [18]

The specific electrical conductivity of uranium has been determined by several authors. The variations in the value obtained ( $3.0$ – $3.38 \times 10^4 \Omega^{-1}\text{cm}^{-1}$ ) are due to variations in the purity and history of the metal. The values determined for specific electrical resistance naturally show similar variation, the mean value at room temperature being ca.  $30 \mu\Omega\text{cm}$ . The specific electrical resistance increases with increasing temperature to ca.  $55 \mu\Omega\text{cm}$  at 873 K. At the transformation points of  $\alpha$ - to  $\beta$ -uranium and of  $\beta$ - to  $\gamma$ -uranium, the curve shows a downward discontinuity but then rises again. The temperature coefficient of the specific electrical resistance in the range 273–373 K is  $2.61$ – $2.76 \times 10^{-3}$ .

Uranium becomes superconducting at very low temperature, but the transition temperature  $T_c$  is very pressure dependent [10]. At atmospheric pressure,  $T_c$  has its lowest value (0.2 K), it reaches its highest value (2.25 K) at 1 Gpa.

The standard electrode potential  $\epsilon_0$  for the reaction

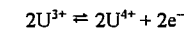
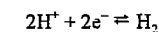

at 25 °C with a 1 mol/L solution of metal ions and a hydrogen electrode is with water  $-0.414$  V, with a 1 mol/L  $\text{HClO}_4$  solution  $-0.631$  V, and with a 1 mol/L  $\text{HCl}$  solution  $-0.640$  V. The thermoelectric potential with copper is ca.  $5 \text{ mV}$  [19].

### 41.3.6 Magnetic Properties

Uranium is paramagnetic. The paramagnetic susceptibility varies with temperature and exhibits discontinuities at the phase trans-

formation points (Figure 41.4). The specific magnetic susceptibility at 298 K is  $1.66 \times 10^{-6} \text{ cm}^3/\text{g}$ .

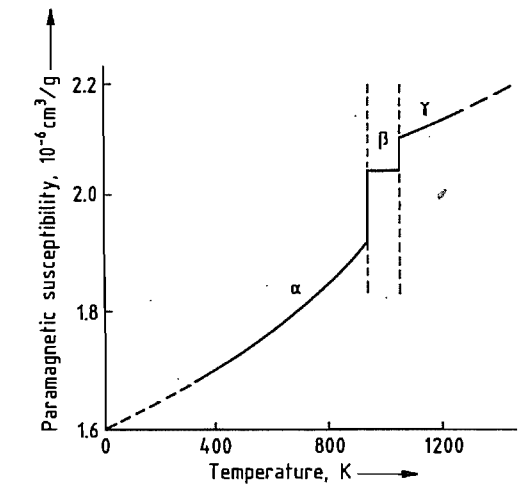
**Figure 41.4:** Paramagnetic susceptibility of uranium.

## 41.4 Chemical Properties

The freshly exposed surface of massive uranium metal has a silvery luster, but it is oxidized relatively rapidly in air. Within a few hours, the metal becomes covered with a thin oxide layer of iridescent colors and eventually turns black. The same mass of metal that is oxidized by steam at 593 K is oxidized by air only above 753 K. The enthalpy and the free energies of formation of oxides from the metal at 298 K are as follows [20]:

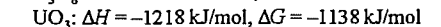
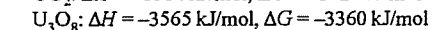
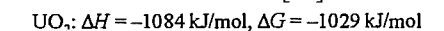

Uranium metal powder is pyrophoric and burns or smolders very readily in air, sometimes spontaneously if the powder has a large enough surface area. Mechanical machining of uranium metal by turning, lathing, and drilling must be carried out with adequate work fluids for lubrication of the cutting tools and for cooling the chippings formed. To store the chippings, they are wetted with a special oil or burned promptly in a controlled manner to form  $\text{U}_3\text{O}_8$ . Uranium does not react with hydrogen at room temperature but combines

readily with it at 498 K to  $\text{UH}_3$ , which decomposes again at 709 K. This behavior is utilized in the manufacture of the powdered metal from its compact form, in which  $\text{UH}_3$  is produced as an intermediate. Also, to reduce the hazard involved in transporting tritium gas, it is currently absorbed by depleted uranium powder in flasks.

Uranium reacts very vigorously with *halogens* and *hydrogen halides*. It burns in fluorine gas to form  $\text{UF}_6$  ("flame reactor"). The reaction with HF gas proceeds only to the  $\text{UF}_4$  stage; reaction with aqueous HF leads to hydrated  $\text{UF}_4$  ( $\text{UF}_4 \cdot 0.75\text{H}_2\text{O}$ ,  $\text{UF}_4 \cdot 2.5\text{H}_2\text{O}$ ). Uranium burns in a stream of chlorine to form  $\text{UCl}_6$  and  $\text{UCl}_4$ . With bromine and iodine, it reacts to only  $\text{UBr}_3$  and  $\text{UI}_3$ . With *sulfur*, grayish black  $\text{US}_2$  is formed, which is stable up to 1273 K.

Powdered uranium reacts very vigorously with *water*, above 308 K the compact metal also reacts with water. Uranium is attacked vigorously by *dilute acids*, with the formation of salts. *Strong solutions of alkali* also attack the metal to form uranates.

## 41.5 Occurrence, Requirement, and Production Figures

### 41.5.1 Occurrence

The mean concentration of uranium in the earth's crust is  $2 \times 10^{-4}\%$ . For comparison, the abundances of cobalt, lead, and molybdenum are similar. Uranium is a typical lithophilic element, occurring mainly in the silicates of the earth's crust. Most of the uranium is distributed widely in small concentrations, both in acidic rocks such as granite, gneiss, and pegmatite, and in sedimentary rock such as schist and phosphatic ores. Basic rocks (basalt) have a lower uranium content than granite, for example. The wide distribution of uranium and the low degrees of enrichment in ores compared with other metals of similar abundance are the result of its ability to form a wide range of chemical complexes. Uranium occurs in more than 100 minerals; those of industrial importance are listed in Table 41.6.

**Table 41.6:** Uranium minerals of industrial importance (detailed information on uranium minerals is given in [21]).

Mineral	Chemical formula	Origin
<i>Oxides, hydrates, simple silicates (uranium, completely or primarily tetravalent)</i>		
Pitchblende	$x\text{UO}_3 \cdot y\text{UO}_2$	Canada, Congo, Western and Central Europe
Uraninite	$\text{UO}_2$ (with $\text{UO}_3$ )	Canada, Colorado Plateau, Argentina
Coffinite	$x\text{USiO}_4 \cdot y\text{U}(\text{OH})_4$	Colorado Plateau
Uranothorite	$x\text{ThSiO}_4 \cdot y\text{USiO}_4$	Canada, Madagascar
<i>Complex deposits of uranium oxides with rare earths (titanates, etc.)</i>		
Brannerite	$(\text{U}, \text{Ca}, \text{Fe}, \text{Y}, \text{Th})_3\text{Ti}_5\text{O}_{16}$	Canada
Betafite (similar to apatite)	$(\text{U}, \text{Ca})(\text{Nb}, \text{Ta}, \text{Ti})_3\text{O}_9 \cdot x\text{H}_2\text{O}$	Madagascar
Davidite	$(\text{Fe}, \text{rare earths}, \text{U}, \text{Ca}, \text{Zr}, \text{Th})_x(\text{Ti}, \text{Fe}^{3+}, \text{V}, \text{Cr}, \text{Y})_y\text{O}_z$	
<i>Secondary minerals with hexavalent uranium</i>		
Gummite	$\text{UO}_3 \cdot x\text{H}_2\text{O}$ (also silicate, phosphate, of indefinite composition)	
Uranophane	$\text{CaO} \cdot 2\text{UO}_3 \cdot 3\text{SiO}_2 \cdot 6\text{H}_2\text{O}$	Colorado Plateau, Argentina
Schrockeringerite	$\text{Na}_2\text{O} \cdot 3\text{CaO} \cdot \text{UO}_3 \cdot 3\text{CO}_2 \cdot \text{SO}_3 \cdot \text{F} \cdot 10\text{H}_2\text{O}$	Joachimsthal, Colorado Plateau, Argentina
Carnotite	$\text{K}_2\text{O} \cdot 2\text{UO}_3 \cdot \text{V}_2\text{O}_5 \cdot 3\text{H}_2\text{O}$	Colorado Plateau, Australia, Argentina
Tjujamunite	$\text{CaO} \cdot 2\text{UO}_3 \cdot \text{V}_2\text{O}_5 \cdot 8\text{H}_2\text{O}$	Turkestan, Colorado Plateau, Argentina
Autunite (torbernite)	$\text{CaO} \cdot 2\text{UO}_3 \cdot \text{P}_2\text{O}_5 \cdot 12\text{H}_2\text{O}$	

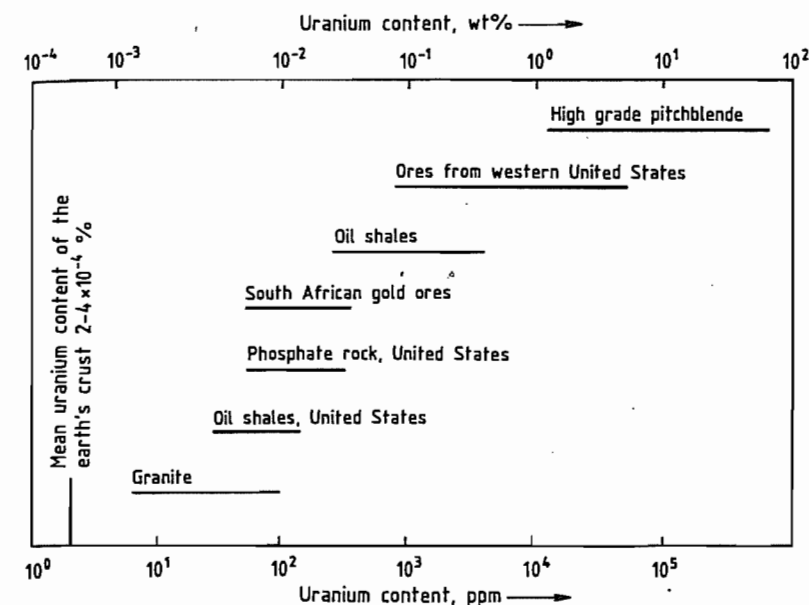

**Figure 41.5:** Uranium concentration in important uranium minerals.

Some materials not regarded as true uranium minerals are the poorly defined uranium-containing bituminous products known as kolm (Sweden), thucholite (Sweden, Canada, South Africa), and asphalt or asphaltite (Colorado Plateau, Argentina). An industrially important mineral, which contains uraninite or pitchblende as accompanying mineral, is monazite. Large deposits of monazite are found in India and Brazil.

Large reserves are also present in seawater because of its enormous volume. However, the uranium level (ca. 3 ppb = 3  $\mu\text{g/L}$ ) is very low. Nevertheless, attempts have been made since the 1950s to extract uranium from seawater. An enrichment factor of  $10^5$  has been achieved. However, the processes will be economical only if enrichment can be increased to ca.  $10^6$ ; the concentration would then correspond to that in a minable ore [22]. Uranium concentrations in the most important uranium-bearing ores in the earth's crust are shown in Figure 41.5 [23]. Approximately half of the annual uranium production comes from secondary minerals. One-third comes from conglomerates in which unweathered rock has been sedimented together with oxidized ura-

nium. The remaining uranium production is from veins or lodes and syngenetic-sedimentary ore deposits.

### 41.5.2 Resources, Requirement, and Production Figures

A 1991 report with data valid for January 1, 1991, issued jointly by the Nuclear Energy Agency of the OECD and the IAEA, gives data on deposits, production, and uranium requirements for 44 countries [24]. This report, for the first time, includes countries from the former Eastern Bloc.

Since then, the data from the former Eastern bloc have become more precisely known and have been more thoroughly evaluated. The development of uranium supply and demand has also changed considerably. Thus considerable quantities of uranium from military projects are now available for civil nuclear energy generation as a result of worldwide nuclear disarmament. Hence OECD/NEA [25] and The Uranium Institute [26] have revised and re-issued their existing reports. The market perspectives have been studied with respect to the question of how the

ever-increasing gap between uranium demand and uranium production can only be bridged by the release of military reserves [27–29].

The known world uranium resources, classified according to the IAEA system by the state of exploration and the anticipated costs per kilogram of uranium extracted, are listed in Table 41.7. The reserves of the following countries are not included in the IAEA classification:

Chile	$0.23 \times 10^3$ t
China	$55.1 \times 10^3$ t
India	$66.15 \times 10^3$ t
Romania	$26.0 \times 10^3$ t
Former Soviet Union	$685.6 \times 10^3$ t
Bulgaria	$45.0 \times 10^3$ t
Former Czechoslovakia	$145.0 \times 10^3$ t
Poland	$20.0 \times 10^3$ t
Total	$1038.98 \times 10^3$ t

On the basis of reports on estimated and speculative reserves, it is assumed that worldwide reserves amount to  $(8-13) \times 10^6$  t of uranium.

Table 41.7: World uranium reserves according to IAEA classification [24], in  $10^3$  t uranium.

Country	Reasonably assured resources		Estimated additional resources (category I)	
	up to \$80/kg U	\$80–130/kg U	up to \$80/kg U	\$80–130/kg U
North America (total)	247.90	323.90	149.00	80.70
Canada	146.00	68.00	149.00	80.00
Mexico	0.00	1.70	0.00	0.70
United States	101.90	254.20	0.00	0.00
Africa (total)	547.02	138.70	380.57	75.50
Algeria	26.00	0.00		
Central African Republic	8.00	8.00		
Gabon	11.00	4.65	1.30	8.30
Namibia	84.75	16.00	30.00	23.00
Niger	166.07	6.65	295.77	10.00
Somalia	0.00	6.60	0.00	3.40
South Africa	247.60	96.80	51.80	30.80
Zaire	1.80	0.00	1.70	0.00
Zimbabwe	1.80	0.00		
Europe (total)	58.27	74.25	23.05	51.35
Austria			0.70	1.00
Denmark	0.00	27.00	0.00	16.00
Finland	0.00	1.50		
France	23.80	15.70	4.20	3.90
Germany	0.60	4.00	1.60	5.70
Greece	0.30	0.00	6.00	0.00
Hungary	1.62	1.50	9.10	9.15
Italy	4.80	0.00	0.00	1.30
Portugal	7.30	1.40	14.45	0.00
Spain	17.85	21.15	0.00	9.00
Sweden	2.00	2.00	1.00	5.30
Australia	469.00	60.00	264.00	126.00
South America (total)	172.53	2.19	96.26	2.09
Argentina	8.74	2.19	0.54	1.95
Brazil	162.00	0.00	94.00	0.00
Peru	1.79	0.00	1.72	0.14
Asia (total)	4.32	27.53	0.00	3.20
Indonesia	4.32	0.00		
Japan	0.00	6.60		
Korea	0.00	11.80	0.00	3.00
Turkey	0.00	9.13		
Vietnam			0.00	0.20
Total	1449.04	626.57	912.88	338.84

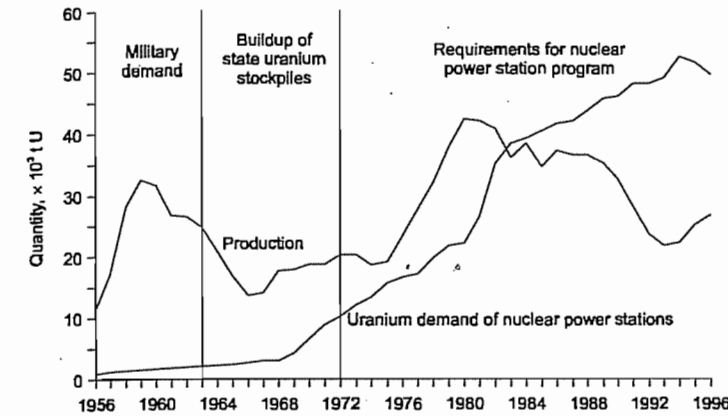

Figure 41.6: Uranium production and demand of the Western World (1956–1996).

**Uranium Production of the Western Countries.** Figure 41.6 shows the uranium production and uranium demand of the Western world in the period 1956 to 1995. In this part of the world, the uranium industry experienced its first boom in the early 1960s. At that time, almost the entire uranium production was consumed by the weapons programs of the western nuclear powers (United States, United Kingdom, France). The civil uranium demand for nuclear power stations began in the late 1960s and early 1970s. This was stimulated by the expansion programs that were established as a result of the oil crisis of 1973. However, the actual expansion in Europe and the United States failed to meet the planned level. Nevertheless, between 1975 and 1980, uranium production grew to meet the increased demand from civil nuclear energy generation. At this time, production of uranium as a by-product of phosphate-rock mining became important. The dramatic decrease in production since 1989 is due to increasing oversupply. Thus, in 1980 the uranium production of the western world was ca. 44 000 t U, but demand was only ca. 22 000 t U. While uranium production continued to decrease, the uranium demand of the civil nuclear energy program grew worldwide. The difference between supply and demand was covered by uranium from stockpiles.

The price development for uranium shows clearly that sufficient quantities of previously

produced uranium are reaching the market, since the uranium price has dropped (Figure 41.7) despite the fact that production has failed to meet demand. Up to 1973, the uranium price remained at a constant \$7/lb U but then increased greatly due to the oil crisis, reaching a peak of \$45/lb U in 1976. The overcapacity existing at this time led to a price drop and eventual stabilization at ca. \$23/lb in 1982. For the reasons discussed above, the uranium price fell slowly up to 1994 and has currently reached temporary stability at a low level.

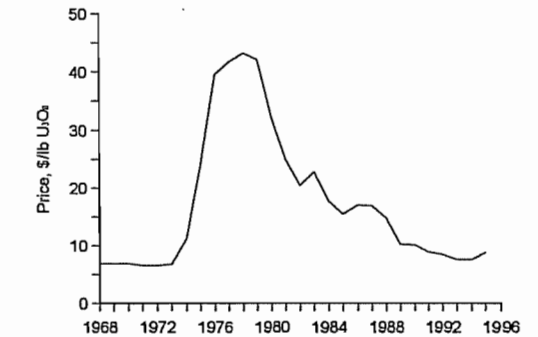

Figure 41.7: Uranium spot market price for European buyers (1968–1995).

**Uranium Production of the Former Eastern Bloc.** In the former Soviet Union, its satellite states, and China, ca. 630 000 t of uranium have been produced since the 1940s (Figure 41.8). Prior to the political and economic liberation of Eastern Bloc in 1989/90, the majority of the uranium produced in the Soviet

sphere of influence was transported to the Soviet Union as a strategic material. Only Romania retained a few thousand tonnes for its CANDU reactor program. Of the uranium produced in the Soviet Union and imported from its satellites up to 1994, probably 450 000 t U was made available for military purposes, and 115 000 t U was used for the nuclear reactor program of the Soviet Union and Eastern Europe. Thus, today Russia should possess a stockpile of ca. 75 000 t U in the form of natural and enriched uranium. Figure 41.9 shows the uranium production of the CIS since 1991. Two of the largest producers, Kazakhstan and Uzbekistan, have essentially no nuclear energy program, so that their entire production should become available to the world market in the form of exports.

**Uranium Production Today.** World uranium production in 1995 was ca. 34 200 t U, 75% of which came from the Western countries and 25% from Eastern Europe, the CIS, and China (Figure 41.10). The 13 largest mines accounted for 70% of world uranium production. The three largest western uranium producers — Cogemá, Cameco, and Uranerzbergbau — were responsible for ca. 44% of world uranium production. Figure 41.11 shows 1994 uranium production divided according to mine owners.

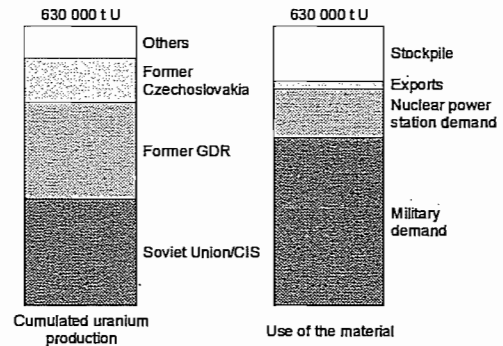

Figure 41.8: Cumulated uranium production in the former Eastern bloc and use of the material (1945–1994).

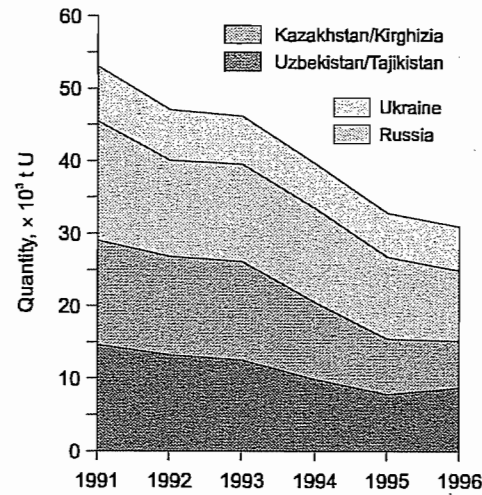

Figure 41.9: Uranium production in the CIS (1991–1996).

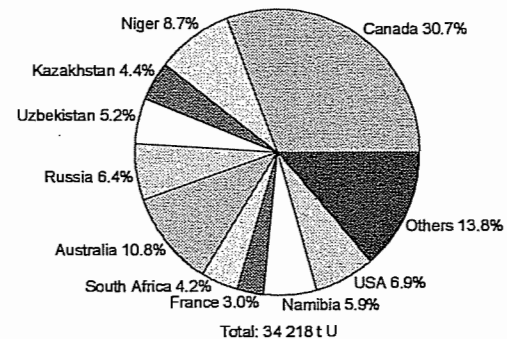

Figure 41.10: World uranium production in 1995 by countries.

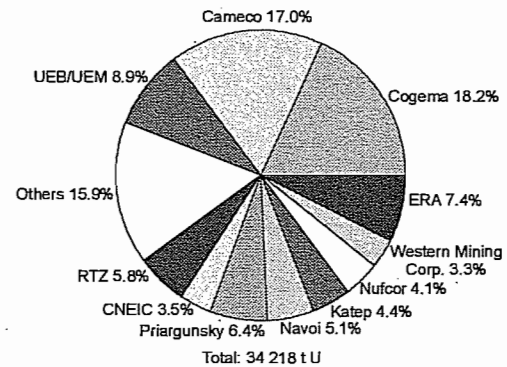

Figure 41.11: World uranium production in 1995, broken down by owners of mines.

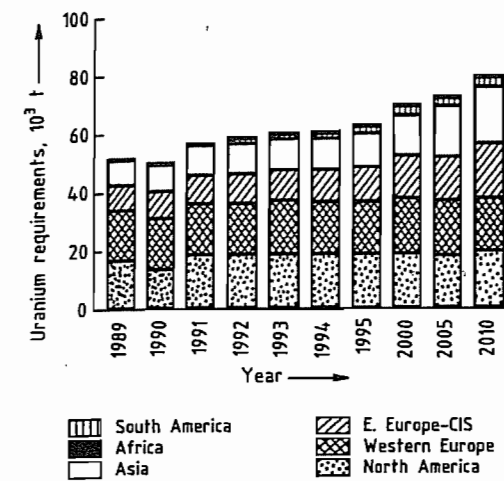

Figure 41.12: Projected uranium consumption for nuclear reactors [24].

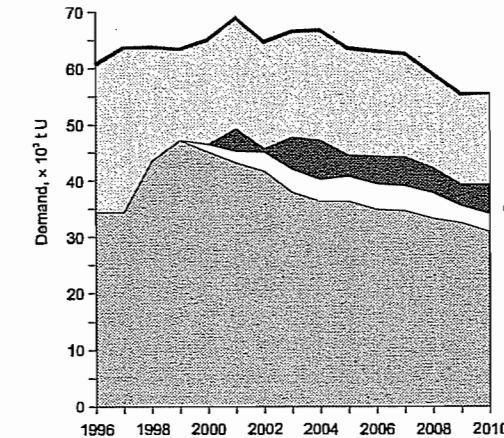

Figure 41.13: Contributions of the production of fresh uranium and uranium inventories to future uranium supply (1996–2010).

**Future Supply/Demand Pattern.** Figure 41.6 shows uranium demand and uranium production up to 1996. Figure 41.12 shows an OECD/IAEA estimate of future uranium demand dating from 1991. World uranium demand in 1991 was 49 300 t U, and this was distributed between the continents as shown in

Figure 41.12. On the basis of planned nuclear energy generating capacity, a uranium demand of ca. 77 700 t U is expected in the year 2010. New investigations of various reference scenarios of The Uranium Institute [26] give values between 70 000 and 80 000 t U. SCHREIBER [29] assumes a demand of less than 60 000 t U and predicts the uranium supply situation shown in Figure 41.13.

World uranium demand will increase slowly for about a decade, after which a downward trend can be expected if it is assumed that nuclear power stations are removed from the grid and not replaced when their licenses expire. This assumption is based on a projection of current energy policies.

Figure 41.13 compares world uranium demand with maximum achievable production capacity. Production capacity is divided into potential projects, mines held in reserve, and plants in operation or for which concrete plans exist. Figure 41.13 shows that world uranium production could double by 2002, but also that the operating, planned, and potential projects will not be sufficient to cover the uranium demand of the nuclear power stations. Hence, in future the existing civil uranium inventories and those that become available from military programs as a result of disarmament will have to be used to meet these demands.

### 41.6 Uses

The intermediate product “yellow cake” is produced from uranium ore. The industrially most important end product is  $UO_2$ , which is the only nuclear fuel used in power station reactors, although uranium carbide (UC) is sometimes used in sodium-cooled fast breeder reactors because of its higher density and superior thermal conductivity compared with  $UO_2$ .

Uranium metal is used as the fuel in materials testing reactors and Magnox reactors. Because of its extremely high density, it is also used in depleted form for trimming weights in large aircraft. A Boeing jumbo jet contains 360 kg of depleted uranium metal. The high

density of uranium metal also utilized in shielding materials for protection against radiation sources (e.g., in portable equipment for weld radiography and medical X-ray equipment).

*U-Zr alloys* are used as nuclear fuel in marine reactors and in research and materials testing reactors. *Hydrogenated U-Zr alloys* ( $UZrH_x$ ) are used as combined fuel-moderator systems in spacecraft reactors. *Uranium silicides* could in principle be used as fuel in light-water reactors. However, uranium silicides are not utilized because undesired reactions with water, the cooling medium, can occur as a result of defects in the fuel elements. *Uranium-aluminum alloys* are used in materials testing and research reactors.

*Uranium salts* are now rarely added to ceramic products to produce luminous colors (e.g., in Merano glassware or tiles) because of the radiation problems involved.

## 41.7 Production

### 41.7.1 From Crude Ore to Yellow Cake

Mined crude ores are prepared for leaching by crushing and grinding. The chemical leaching process is selected according to the mineralogical nature of the ore. Acidic ores are treated with dilute  $H_2SO_4$ , and alkaline ores with an aqueous solution containing sodium carbonate and sodium bicarbonate. Phosphatic ores are treated with acid.

Solid-liquid separation of leached ore is achieved by standard processes such as filtration, multistage decantation, and hydrocyclone separation; uranium is recovered from the solution by ion exchange or solvent extraction. Combining these two techniques, as in the Eluex process, is also advantageous. Yellow cake is then produced by precipitation from the acid liquor with ammonia or  $Mg(OH)_2$  or by precipitation from the alkaline liquor with NaOH.

Uranium is obtained as an accompanying element from phosphatic ores in which the

uranium content is very low (see Section 41.5.2). After acid treatment, uranium is purified and recovered by the stripping process. Uranium is precipitated as ammonium uranyl carbonate (AUC).

### 41.7.2 From Yellow Cake to $UF_6$

In the wet treatment process, yellow cake is dissolved in  $HNO_3$  and purified by solvent extraction. The resulting solution of uranium in nitric acid can then be reacted chemically to form  $UO_2$  or  $UO_3$  by using either the ammonium diuranate (ADU) or the AUC process, or by denitrating evaporation.

$UO_2$  is converted into  $UF_6$  in two stages: first  $UF_4$  is produced by treatment with HF;  $UF_4$  is then converted into  $UF_6$  by treatment with fluorine gas. In principle, yellow cake can also be processed in the dry state. After size reduction and preliminary purification, yellow cake is calcined to form  $UO_2$ , which is then converted into  $UF_6$  as described above. However, the dry  $UF_6$  so obtained must then be purified by fractional distillation.

### 41.7.3 From $UF_6$ to the Nuclear Fuel $UO_2$

If  $UF_6$  is to be converted to the nuclear fuel  $UO_2$  for light-water reactors, an enrichment process must be carried out for reasons of reactor physics until the  $^{235}U$  isotope content is between 2 and 6%. Enrichment processes commonly used include the diffusion process, the nozzle process, and centrifugation.

Enriched  $UF_6$  can be processed by either wet methods (e.g., AUC, ADU) or dry methods [e.g., Integrated Dry Route (IDR), Direct Conversion (DC), General Electric Dry Conversion (GECO)] to obtain  $UO_2$  powder. After chemical conversion and before pelletization, the powder must be pretreated (except in the case of precipitation by the AUC process). Only after pretreatment do the various steps of pelletization (compression, sintering, and grinding) give an end product with the desired spectrum of properties.

## 41.7.4 Detailed Description of the Processes

### 41.7.4.1 Digestion and Leaching of Ores

Before ore digestion appropriate pretreatment is essential. This includes size reduction for which several stages are necessary. In the first stage, lumps of ore ca. 1 m in diameter are passed through gyratory or jaw crushers with a power consumption of 250–350 kW. These reduce the ore to lumps of ca. 200 mm diameter. Cone crushers with a power consumption of 30–40 kW are used in the second stage, giving pieces of ore ca. 65 mm in diameter. Particle sizes of < 10 mm are obtained in the third stage, in which fine cone crushers or roller crushers with power consumption of 15–20 kW are used [30, 31]. This degree of size reduction is adequate with most types of ore for which the much more usual sulfuric acid process is used. Finer grinding is necessary only for alkali treatment. Here screen mills and ball mills are used in succession to reduce the particle size of the ore to ca. 0.5 mm.

Consideration of the economics of the complete process of grinding and chemical treatment must include the question of whether preliminary removal of worthless material (gangue) might be beneficial. However, except for visual hand sorting of lump materials, no industrial process has thus far been used. Pilot-scale experiments in Elliot Lake, Canada, have been reported (Table 41.8) [32].

Table 41.8: Separation methods: amounts of worthless material removed and consequent uranium loss [32].

Method	Worthless material removed, %	$U_3O_8$ loss, %
Flotation after grinding to < 0.3 mm	62–80	8
Gravitational method	ca. 35	8
Radiometry method	ca. 20	8
Magnetic separation	ca. 85	14

### Acidic Ores

Dilute sulfuric acid is always used for the acid treatment of ores. The rate of dissolution

depends on acid concentration, temperature, and surface area of the ore particles. If the ore contains feldspar and clay, highly concentrated acid should not be used since it will dissolve aluminum silicates. If the particles are ground too finely, clarification of the cloudy solution can present some problems. If tetravalent uranium is present, an oxidizing agent (sodium chlorate or manganese dioxide) is added to the liquor, with dissolved iron acting as a catalyst. The following reactions occur during the dissolution process:

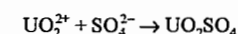
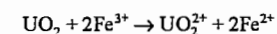
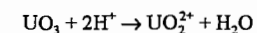

At higher acid concentration, complex anions such as  $[UO_2(SO_4)_3]^{4-}$  are also formed, but these do not cause problems in later processing.

### Alkaline Ores

Alkaline ores require treatment with alkaline solutions. Alkaline leaching is considerably slower than acid leaching, but is more effective for ores in which the gangue materials contain calcium compounds or other acid-consuming components. For alkaline treatment the ore must be more finely ground. Since carbonate solution does not attack this type of gangue, uranium is dissolved much more selectively than when acidic solutions are used, and the subsequent concentration stage is easier. The dissolution of uranium is due to the formation of a tricarbonato complex:

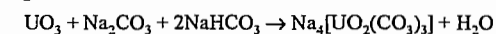

The above ratio of carbonate to hydrogen carbonate should be maintained. If tetravalent uranium is present, oxygen is used as an oxidizing agent, and higher temperature and pressure are applied. This oxidation is catalyzed by copper sulfate and ammonia.

### Digestion of Phosphate Rock

Uranium is present in phosphate rock at a mean concentration of 100–150 mg/kg. Flor-

ida phosphate rock, for example, contains 110 mg/kg uranium. Total uranium reserves in phosphate rock are currently estimated at ca.  $7.1 \times 10^6$  t [24], which is nearly twice as much as the world reserves with beneficiation costs of < \$130 per kilogram uranium.

Most phosphate rock minerals are members of the apatite group, having the typical composition  $\text{Ca}_{10}(\text{PO}_4)_6(\text{OH}, \text{F}, \text{Cl})_2$ , in which calcium is replaced to a small extent by  $\text{U}^{4+}$ , which is of similar size ( $\text{U}^{4+}$ , 0.097 nm;  $\text{Ca}^{2+}$ , 0.099 nm). The presence of uranium is due to the formation of phosphate deposits from seawater, which contains 3  $\mu\text{g/L}$  uranium. In the presence of organic reducing agents or Fe(II) ions, U(VI) is reduced to U(IV), which is incorporated into the apatite lattice.

When apatite is treated with dilute sulfuric acid at 80–135 °C to form crude phosphoric acid, uranium also goes into solution. However, if apatite is treated by the dry method or with concentrated sulfuric acid to form superphosphate, uranium is not dissolved but remains in the product. In Israel (only), uranium is first dissolved with hydrochloric acid when using the dry method. Two processes for extracting uranium from phosphoric acid solution have been put into practice, oxidation stripping and reduction stripping.

#### 41.7.4.2 Treatment of the Solution

Uranium can be removed from the solution by ion exchange, solvent extraction, or a combination of the two processes known as the Eluex process. Undissolved solids, which would have a detrimental effect, are usually removed first from the liquor by sedimentation or decantation, or with hydrocyclones, filters, or centrifuges. The best process is vacuum filtration using plane, band, or drum filters, because the solution should be diluted as little as possible by washing of the filter cake.

Whereas slight cloudiness is tolerable for the ion-exchange process, the liquor must be clarified as much as possible before solvent extraction is carried out, because the expensive extraction agent can be lost by adsorption

by the solids, which can lead to environmental pollution.

#### Uranium Recovery by Ion Exchange

Anionic complexes of uranium are present in both acid and alkaline uranium solutions. Strongly basic ion exchangers are generally used to extract these complexes:

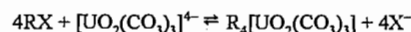
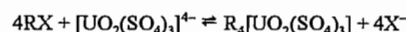

where R denotes the matrix and X the functional basic group of the ion exchanger.

The pH is adjusted to 1.5–2 in sulfuric acid solutions and to 9–10 in alkaline solutions for the ion-exchange process, which can be operated batchwise (fixed-bed process) or continuously.

**Fixed-Bed Process.** In the fixed-bed process, cylindrical columns of diameter 2–3 m, height 4–5 m, containing 10–30 m<sup>3</sup> resin are used. The ion-exchange resin is loaded at a flow rate of 5–20 m<sup>3</sup>/h and eluted at 1–5 m<sup>3</sup>/h. The resin pebble bed usually consists of spherical particles of diameter 0.3–0.8 mm, but 2-mm-diameter granules may be needed to prevent blockage of the columns if solutions are incompletely clarified. For such solutions, the resin in pulp (RIP) process was developed, in which large resin granules are held in sieve baskets that are moved to and from in a horizontal flow of unclarified liquor.

Elution can be carried out with 1 mol/L solutions of chlorides and nitrates. However, these anions interfere with subsequent loading of the resin, so elution with sulfates is often preferred. This proceeds more slowly but does not affect loading of the resin and is more cost-effective. The resin is first eluted with a 1 mol/L sulfate solution and subsequently treated with 10% sulfuric acid or, in the case of alkaline uranium solutions, with 1–2 mol/L sodium carbonate–sodium hydrogencarbonate solution.

**Continuous Ion-Exchange Processes.** Several types of columns have been developed for continuous ion exchange. The first is exempli-

fied by the *Higgins column*, which has been operated successfully in Texas and Wyoming since 1955 [33]. Resin is loaded as it is pushed slowly upward through the column. It is washed at the overflow at the top and then passed to elution columns. Similar columns have been used successfully by the Bureau of Mines in South Dakota. In 1977, the *Himsley column* was installed in Ontario, Canada, and the *Cloete-streat column* in South Africa. In the *Porter column*, which was installed in Namibia in 1978, uranium solution flows upward and overflows from the top into a second ion-exchange column at a slightly lower level. The laden resin is drawn off from the bottom by means of compressed air and fed via an intermediate tank into elution columns.

Although ion-exchange resins have been improved considerably in recent years, the trend now is toward solvent extraction or a combination of ion exchange and solvent extraction (Eluex process) because these processes give better selectivity and, hence, improved product purity.

#### Uranium Recovery by Solvent Extraction

Two types of extraction solvents are used: the first includes alkylated phosphoric acids and pyrophosphoric acids; the second, higher aliphatic amines. Both types are dissolved in inert hydrocarbons, mostly high-purity kerosene. The mechanism of extraction is based on ion exchange in the liquid phase. Tributyl phosphate (TBP), which is used in the production of high-purity uranium, cannot be used for liquid–liquid extraction of sulfuric acid liquors because neutral extraction media are not suitable for uranyl sulfate solutions.

**Solvent Extraction with Phosphoric Acids.** The following three phosphoric acids have been found suitable for extraction of uranium:

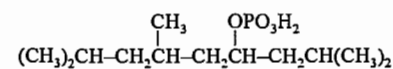

Isododecyl phosphate

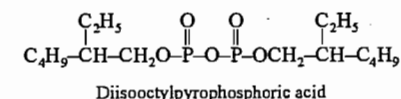
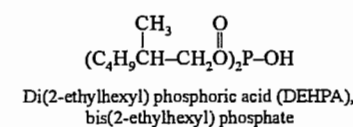

In the extraction process, acidic hydrogen atoms of phosphoric acids are replaced by the uranyl ion. The exchange therefore also depends on the pH of the solution. The complexes formed are soluble in the organic phase. In contrast to extraction with neutral organophosphorus compounds, the anion of the uranyl salt is not extracted at the same time:

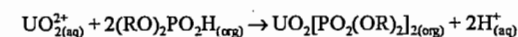

Extraction can be much improved by adding tributyl phosphate to the phosphoric acid (synergistic effect). Concentrated mineral acids or sodium carbonate solutions are used to strip uranium from the organic solvent.

**Solvent Extraction with Amines.** Newer uranium processing plants use mainly amines as extraction solvents. These are usually commercially available mixtures of either highly branched dialkylamines or straight-chain trialkylamines. Solutions of these amines in hydrocarbons have a strong affinity for uranyl sulfate and form addition complexes of the type  $(\text{R}_3\text{NH}^+)_2[\text{UO}_2(\text{SO}_4)_2]^{2-}$  that are soluble in organic solvents. Uranium can be stripped from these solutions by simple ion exchange with solutions of the nitrate or chloride of sodium or ammonium. Sodium carbonate solutions, which are sufficiently basic to convert the amine salt into free base, can also be used.

**Technique of Solvent Extraction.** Only a few column types are suitable for solvent extraction; these include the rotating disk column and the Scheibel column. However, the most suitable type is the mixer–settler in its various forms. A continuous mixer–settler consists of a mixing chamber and a settling chamber. The mixing chamber is provided with an agitator to mix the two phases (aqueous and organic).

The organic phase is fed by gravity from the preceding settling chamber into the inlet at the top of the mixing chamber, while the aqueous phase from the next settling chamber enters the mixing chamber from below. The mixed phases pass through an outlet at an intermediate height into the settling chamber in which the two phases separate. Thus, the phases flow countercurrently, and each mixer-settler constitutes one stage of the exchange process. Mixer-settlers are used for both the extraction and the stripping stages.

Four-stage mixer-settlers of various designs are used for industrial-scale solvent extraction. For example, in the Davy Power Gas mixer-settler, the mixed phases flow out centrally in upward direction. The Israel Mining mixer-settler contains lamellar internals to promote rapid phase separation [34]; these enable throughput rates to be improved by a factor of 20. The Lurgi MultiTray settler is aimed at a similar result [35]. Optimization of design and operation is described in [36].

### Eluex Process

In the combined Eluex process, uranium is crudely separated by means of an ion-ex-

change resin, followed by solvent extraction [37]. The ion-exchange resin is designed so as to tolerate as much "cloudiness" as possible, and uranium is collected almost quantitatively. Breakthrough of foreign ions is acceptable since these are removed easily in the second (solvent extraction) stage. In this combined process, the first stage has the useful effect of increasing the concentration of uranium, with consequent reduction in the mass flow. This enables the second stage to be smaller by a factor of 20–30, and also improves the purification effect of this step as the uranium concentration in the feed is higher. An additional advantage is that the process can be used with relatively low uranium concentrations in the leach liquor (low-grade uranium ore). Thus, for example, the ion-exchange stage increases the concentration of a starting solution containing 0.02–0.5 g/L  $U_3O_8$  to 9–12 g/L  $U_3O_8$  and reduces the mass flow by the same factor. Four industrial plants processing 1000–1200 t/d ore are operating in the United States [38]. In South Africa, the technique was developed in 1963 under the name "BuMex Process", and full-scale operation followed.

Table 41.9: Specifications for uranium concentrate (yellow cake), contents in %.

	British Nuclear Fuel (UK)	Comurhex (France)	Eldorado (Canada)	Allied Chemical (USA)	Kerr McGee (USA)
U	40	60	50	75	60
Moisture	10	5	5.0	2.0	
Insolubles in $HNO_3$		0.1	0.1		0.1
Granulation, m	6.68	6	6.25	6.25	6.25
Th	not available	not available	2.0		2.0
Mo	< 0.6	0.45	0.15*	0.1	0.15*
$V_2O_5$	< 1.00	1.80	V = 0.1	0.1*	0.1*
Ca		1.15	1.0	0.05	1.0
$P_2O_5$	< 6	1.1	P = 0.35	$PO_4 = 0.1$	P = 0.35
Cl, Br, I	< 0.5	0.25	0.25*	0.05	0.25
F		0.15	0.15*	0.01	0.15
$SO_4$		10.50	S = 3.5	S = 3.00	S = 3.5
Fe				0.15	
As	< 2.00	1.0	1.0	0.05	1.00
$CO_3$	< 2.00	2.0	2.00	0.20	2.00
B	< 0.2	0.15	0.15	0.005	0.15
Na		not available		0.50*	
K		not available		0.1	
$SiO_2$	< 4.00				
Zr					2.00

\*Maximum concentration without cost penalties.

### 41.7.4.3 Production of Uranium Concentrate

#### From Precipitation to Yellow Cake Production

Solutions obtained by the above processes contain uranium in the form of its sulfate or the carbonate complex  $Na_4[UO_2(CO_3)_3]$ . Uranium is precipitated from this as a uranate by addition of base, filtered, and dried. The uranium concentrate obtained, known as "yellow cake" because of its color and form, is the basic material for the production of nuclear fuels. Commercial uranium concentrates of various origins are listed in Table 41.9. Precipitation is carried out in large, agitated vessels. The precipitating agent for acidic, sulfate-containing solutions is ammonia or  $Mg(OH)_2$ , whereas carbonate complexes are precipitated by a 50% solution of NaOH.

#### Processing of Phosphate Liquor and Precipitation of AUC

**Oxidation Stripping Process.** In oxidation stripping, U(VI) is first converted into U(IV) by adding Fe(II) salts to the phosphoric acid; uranium is then extracted from the orthophosphoric acid by mono- and dioctylphenyl esters mixed with kerosene. Stripping is by oxidative treatment with phosphoric acid and sodium chlorate ( $NaClO_3$ ). The U(VI) is again extracted from the stripping solution at 40–50 °C, this time by trioctylphosphine oxide (TOPO) and 2-ethylhexyl phosphate (DEHPA) dissolved in kerosene; it is then reductively stripped from this extract by addition of Fe(II). Multiple recycling of the stripping solution gives an enrichment factor of 40. The stripping solution is then reoxidized by  $NaClO_3$  and extracted with DEHPA–TOPO–kerosene. Phosphoric acid is washed out of the extract, which is then stripped with  $(NH_4)_2CO_3$  solution. An excess of ammonium carbonate is added in the cold to the complex salt solution obtained, precipitating ammonium uranyl carbonate,  $(NH_4)_4UO_2(CO_3)_3$ .

This is filtered off, washed, and calcined to give  $UO_{2+x}$ .

**Reduction Stripping Process.** Reduction stripping proceeds in an almost identical manner, except that only one extraction medium (DEHPA–TOPO–kerosene) is used. Uranium from the first stage is thus not reduced but extracted as U(VI). Both stripping stages are therefore reductive. Uranium does not require further purification in these cases and is usually purer than normal yellow cake.

### 41.7.4.4 Final Purification of Uranium Concentrate

#### Dissolution of Yellow Cake

Yellow cake produced by mining companies is not a single chemical substance, but a mixture of uranates. Its composition depends on the mined ores, as mentioned above, and on the chemistry of the treatment process suitable for those ores. The uranium content and the nature and concentration of impurities vary. However, the manufacture of nuclear fuel requires a product of high purity and constant composition, and the fine purification processes are intended to achieve this aim.

On an industrial scale, wet processes are used mainly to treat yellow cake, which must therefore first be brought into solution. This is achieved with hot nitric acid, which dissolves the uranium as uranyl nitrate. Impurities settle out to some extent or may also be dissolved as nitrates.

#### Extractive Purification

In the extractive stage of purification, uranium is separated from the accompanying impurities as far as possible. Removal of elements with a high cross section for thermal neutrons (e.g., boron, rare earths, cadmium, and lithium) is especially important.

Purification is carried out by dissolving the uranium concentrate in nitric acid and extracting uranium with selective solvents. Currently, TBP diluted with hydrocarbons is used in al-

most all known purification plants. A complex is formed according to



The complex is neutral, anhydrous, and undissociated, and has a higher solubility in the organic than in the aqueous phase. The uranyl nitrate solutions contain an excess of free nitric acid (sometimes nitrates of alkali metal, alkaline-earth metal, or aluminum are added), which has a salting-out effect and improves the distribution coefficient between the organic and inorganic phases. The tributyl phosphate solution is then treated with pure water, and uranyl nitrate is transferred back to the aqueous phase. The distribution coefficient is temperature dependent, and hot water (50–60 °C) is preferred for this stripping process.

Other heavy-metal nitrates can also form complexes with TBP. The more completely the amount of tributyl phosphate present in solution is bonded to  $\text{UO}_2(\text{NO}_3)_2$ , the smaller is the extent to which other heavy-metal nitrates are extracted. Therefore, a high degree of saturation of tributyl phosphate with uranyl nitrate is necessary. To reduce the density of tributyl phosphate (which is close to that of water) and to lower its relatively high viscosity, it is diluted with inert, saturated hydrocarbons. Kerosene and *n*-hexane are generally used, giving solutions that usually contain 25–35% TBP.

Harmful impurities in uranium solutions include gypsum and soluble silica, which can be deposited in the solvent extraction apparatus and reduce the efficiency of extraction. Also, some anions, especially sulfate and phosphate, cause problems by forming complexes with uranium. These complexes are not extracted and therefore lead to uranium losses. Fluorides and chlorides in the presence of nitric acid can cause severe corrosion of the vessel material.

Tributyl phosphate also contains impurities that interfere with extraction. Some of these are present in the commercial product as supplied; others are formed by chemical attack and by radiation. The main impurities are dibutyl- and monobutylphosphoric acids. Although dibutylphosphoric acid extracts ura-

nium more effectively, it is less selective than tributyl phosphate (i.e., impurities are extracted at the same time). These make the stripping of uranium more difficult. Acids can be removed by washing them out of the tributyl phosphate (e.g., with sodium hydroxide solution).

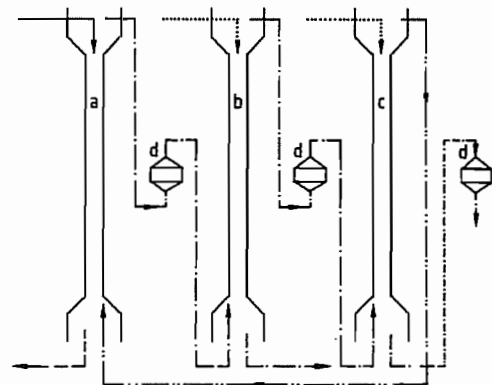

**Figure 41.14:** Schematic of a solvent extraction plant: a) Extraction column; b) Washing column; c) Stripping column; d) Diatomite filter. — Impure  $\text{UO}_2(\text{NO}_3)_2$  solution containing 275 g/L U, 3 mol/L  $\text{HNO}_3$ ; — Depleted solution (0.1 g/L U) passing out of extraction column; - - - Solution of uranyl nitrate in TBP; - · - · Depleted solution (1–3 g/L U) of uranyl nitrate in TBP; ···· Water; - - - Aqueous solution of  $\text{UO}_2(\text{NO}_3)_2$ .

**Technique of Solvent Extraction.** The concentrate is dissolved in nitric acid, and the concentrations of uranium and nitric acid in the unfiltered solution are adjusted to the desired values, usually 250–350 g/L uranium and 1–3 mol/L free nitric acid. Before being fed to the solvent extraction plant, the solution is filtered in some plants. Various types of extractors (Figure 41.14) are used in solvent extraction plants. Pulsed sieve tray columns are the most popular, but mixer-settlers are also used in some cases. Pulsed columns and mixer-settlers are used both for solvent extraction and for washing and stripping. The columns contain perforated stainless steel plates ca. 50 mm apart. The holes are 3–5 mm in diameter, and the total area of all the holes is ca. 23–25% of the area of the plate. In the first column, uranyl nitrate is extracted by the solvent (25% TBP in kerosene). The volume ratio of the two phases is set such that maximum

saturation of the organic phase with uranyl nitrate, together with almost quantitative extraction (> 99.9%) is achieved. In the second column (washing column), the organic phase is washed with a small amount of deionized water to remove impurities extracted at the same time. A volume ratio of organic phase: water = 10:1 is adequate. In this washing process, uranium is also partly transferred into the washing water. This solution is therefore recycled to the process. After the organic phase has been washed, it passes into the stripping column where uranyl nitrate is stripped out by hot (60 °C) deionized water. After treatment of the organic solvent with  $\text{Na}_2\text{CO}_3$  to remove hydrolysis products of tributyl phosphate and the remaining uranium (a step not always included in the process), the organic solution is fed back to the first column.

#### 41.7.4.5 Production of $\text{UO}_3$ and $\text{UO}_2$ from Purified Uranyl Nitrate Solution

Two different methods have been developed for the production of  $\text{UO}_3$  and  $\text{UO}_2$  from uranyl nitrate solution. In the first of these, the uranyl nitrate solution is evaporated until uranyl nitrate hexahydrate is completely crystallized; and this is then converted into uranium trioxide by thermal decomposition. Alternatively, uranium is precipitated in the form of an insoluble compound, and this precipitate (usually an ammonium salt) is converted into uranium trioxide. Common to both processes is reduction of the uranium trioxide  $\text{UO}_3$  obtained to uranium dioxide  $\text{UO}_2$ . The two processes are compared in Figure 41.15.

#### Evaporation of Uranyl Nitrate Solution and Denitration by Thermal Decomposition

Solutions of uranyl nitrate are evaporated until uranyl nitrate hexahydrate,  $\text{UO}_2(\text{NO}_3)_2 \cdot 6\text{H}_2\text{O}$ , begins to crystallize. Further evaporation leads to the liberation of nitrogen oxides and water:

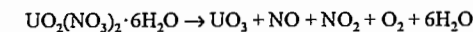

This decomposition and the phase diagram of the hydrated uranyl nitrate have been investigated thoroughly. The phase diagram (Figure 41.16) shows that the hexahydrate and the trihydrate have incongruent melting points at 60 and 113 °C, respectively. The uranyl nitrate–water system is stable up to 184 °C, the melting point of the dihydrate. Above this temperature, decomposition to uranium trioxide occurs with liberation of nitrogen oxides. This reaction becomes much more rapid above 300 °C. Since uranium trioxide loses oxygen above 430 °C [39], 400 °C is considered the optimum temperature for producing  $\text{UO}_3$ . In order not to reduce the reactivity of  $\text{UO}_2$  in later process steps (reduction, sintering, or hydrofluorination), avoiding higher temperatures, at which the  $\text{U}_3\text{O}_8$  phase could be formed, is desirable.

**Evaporation.** The design of evaporation plants depends on the initial concentration of solutions to be evaporated. Since nitric acid at low concentration (up to 0.05 mol/L) is handled, the construction material is stainless steel. Vertical tube evaporators and evaporation tanks heated by internal steam pipes are commonly used. The final concentration of uranyl nitrate for the subsequent denitration stage is established by means of temperature control. Thus, a temperature of 120 °C corresponds to a uranium concentration of ca. 1000 g/L, and 143 °C to ca. 1285 g/L, the solution fed to the denitration stage being produced at a concentration between these two. The melting point of the less concentrated solution is 60 °C, and that of the more concentrated solution 116 °C. Because these melting points are relatively high, care must be taken to prevent the melt from solidifying in any part of the system (e.g., by heating the pipework). Concentrated uranyl nitrate solution is stored in heated tanks before being pumped to the denitration stage.

**Denitration.** *Batchwise denitration* was carried out in stainless steel pots containing fairly powerful agitators but the batch process is rarely used today.



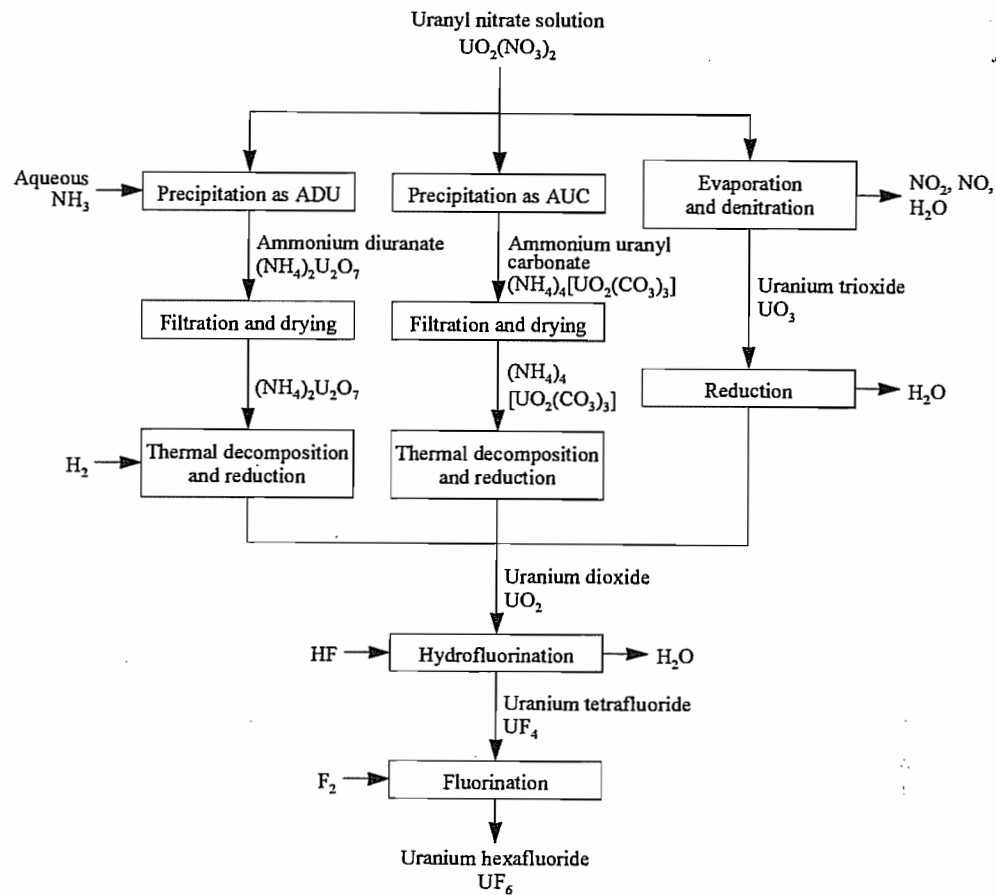

Figure 41.15: Methods for the production of  $UF_6$ .

**Continuous Denitration.** The continuously operating furnace first used in 1956 in a plant in Hanford (Washington) consists of a horizontal trough with a central stirring device. Uranyl nitrate is fed via rotameters through the inlets to the decomposition trough, and the  $UO_3$  formed flows out over a weir into a powder receiving vessel.

The temperature in the bed of powder largely determines the water and nitrate content of the powder. The nitrate content varies between 1.1% at 242 °C and 0.02% at 454 °C. At these temperatures, the water contents are 2.6 and 0.1%, respectively. Here, too, higher bed temperature leads to powder with lower reactivity.

The mean particle diameter of the powder is ca. 150  $\mu m$ . In comparison to  $UO_3$  powder produced by other processes, all powder produced by thermal decomposition of uranyl nitrate has a relatively high bulk density (ca. 3.5–4.3  $g/cm^3$ ) (i.e., the individual particles are very dense).

In the course of development work on equipment, Argonne National Laboratory started to develop a *fluidized-bed denitration furnace* as early as 1953. Fluidized-bed furnaces are now used widely not only in this stage but also in the reduction stage, for example.

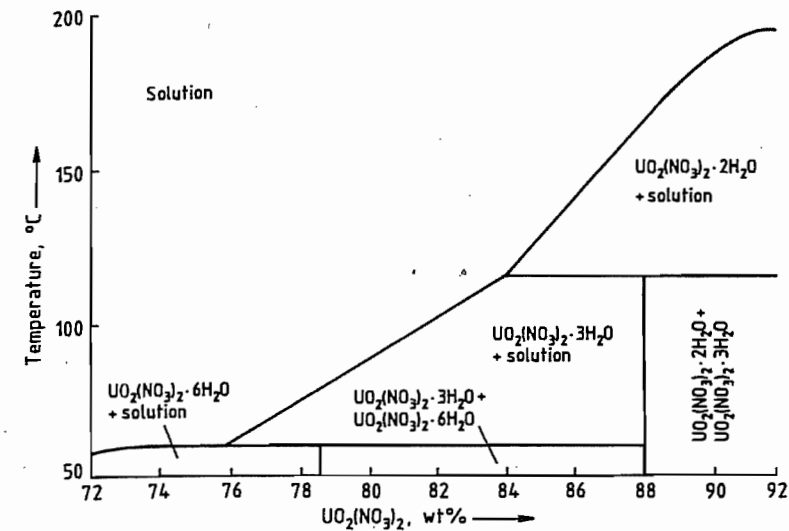

Figure 41.16: Phase diagram of the system  $UO_2(NO_3)_2-H_2O$ .

Denitration is carried out by spraying uranyl nitrate solution onto a fluidized bed of hot particles of  $UO_3$ . Carrier air is introduced from below through a porous metal filter and into the reaction tube where it fluidizes the bed of powder. Gaseous reaction products pass through sintered metal cartridges at the top of the reaction tube, and the nitrogen oxides are subsequently absorbed in water. The mean particle diameter is 150–200  $\mu m$ . A fluidized-bed reactor of a type still often used today is illustrated in Figure 41.17.

### Precipitation of Uranium by the ADU and AUC Processes

The sparingly soluble compounds ammonium diuranate (ADU),  $(NH_4)_2U_2O_7$ , tetraammonium diooxocarbonatouranate or ammonium uranyl carbonate (AUC),  $(NH_4)_4[UO_2(CO_3)_3]$  and uranium peroxide,  $UO_4 \cdot 2H_2O$ , can all be used to precipitate uranium. All three compounds form uranium trioxide on thermal decomposition in air,

although precipitation of uranium peroxide is now rarely used industrially.

**The ADU process** was the first to be operated on an industrial scale and is still used widely today [40]. Precipitation of uranium from aqueous solution by ammonia gives a nonstoichiometric precipitate whose composition does not correspond to the chemical formula. Instead, the molar ratio  $NH_3:U$  varies between 0.3 and 0.45. The properties of ammonium diuranate and of uranium dioxide produced from it can be influenced within limits by changing the operating conditions. Important parameters that determine particle size and particle-size distribution include temperature, precipitation time, initial concentration, and intensity of agitation. A relatively large size of agglomerated particles is obtained by using urea as the precipitating agent [41] or by passing a mixture of  $NH_3$  and air into the solution [42]. Depending on the plant, precipitations can be carried out continuously or batchwise. The precipitate is separated from the mother liquor with the aid of continuous filters and centrifuges.

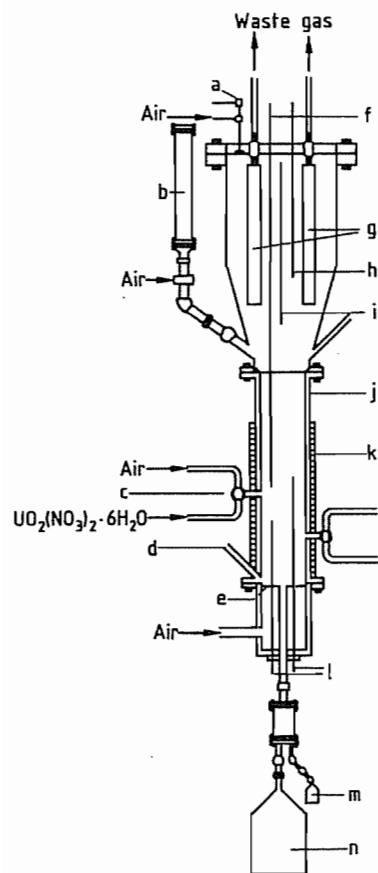

**Figure 41.17:** A 10-inch fluidized bed for denitration of  $\text{UO}_2(\text{NO}_3)_2 \cdot 6\text{H}_2\text{O}$  (laboratory plant): a) Safety valve; b)  $\text{UO}_3$  for charging; c) Spray nozzle; d) Pressure compensation; e) Porous filter plate (steel); f) Bed level detector; g) Porous filter; h) Separating plate; i) Thermocouple; j) Reaction tube; k) Heating element; l) Thermocouples; m) Sampling device; n) Receiver.

**AUC Process** [43, 44]. The AUC process was developed for precipitating uranium from fluoride-containing solutions (from the hydrolysis of  $\text{UF}_6$ ) because the fluoride contained in precipitated AUC (produced by addition of  $\text{NH}_3$  and  $\text{CO}_2$ ) can be removed nearly completely by washing, in contrast to ammonium diuranate precipitated by  $\text{NH}_3$ . Because of the high-quality  $\text{UO}_2$  powder obtained from the precipitated product, this process was also used for uranyl nitrate solutions. The equations of these reactions are as follows:

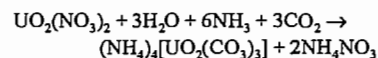
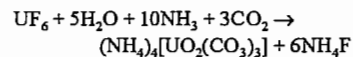

Ammonia and carbon dioxide pass through a system of jets into a reaction tank filled with water, and uranyl nitrate solution is added at the same time at a controlled rate. The aqueous solution is pumped around a circulating system for the entire period during which reactants are added. The temperature of the water and the suspension increases because of liberation of heat of solution and reaction. When it reaches  $60^\circ\text{C}$ , the suspension is cooled to prevent excessive decomposition of the ammonium carbonate formed. After cooling to room temperature, the suspension is fed to a rotary disk filter, and after washing the precipitate with water, residual water is removed by suction until the moisture content is ca. 8%. If desired, the product can be dried further by washing with alcohol. The filter is discharged by rotating it while a knife fixed to a moving arm travels from the center to the edge of the filter over a period of up to 3–4 h, removing the filter cake in a thin layer. The powder is fed by a pneumatic suction device through the air lock of the fluidized-bed furnace.

### Reduction of Precipitated Product to $\text{UO}_2$ Powder

Ammonium diuranate or ammonium uranyl carbonate can be reduced to uranium dioxide either immediately or after drying. The reduction temperature is  $500\text{--}700^\circ\text{C}$ . Hydrogen or cracked ammonia (i.e., an  $\text{N}_2\text{--H}_2$  mixture) can be used as reducing agent. Most reducing furnaces used today are continuously or discontinuously operated fluidized-bed furnaces.

**Batchwise Process.** A discontinuously operated fluidized-bed furnace is used in the AUC process (Figure 41.18). The precipitated product in powder form is fed in small portions of ca. 0.5 kg through a cellular wheel sluice into the furnace, where it decomposes to uranium dioxide in the hot, reducing atmosphere of the

furnace. The gases liberated are passed through porous metal filter cartridges. Water vapor is used as the carrier gas for fluidization, and hydrogen is the reducing gas; these are fed through a fritted metal plate.

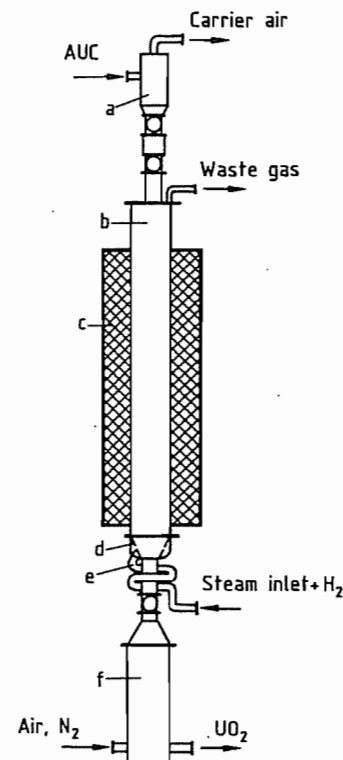

**Figure 41.18:** Fluidized-bed furnace for reduction of  $(\text{NH}_4)_2\text{U}_2\text{O}_7$  (ADU) or  $(\text{NH}_4)_4[\text{UO}_2(\text{CO}_3)_3]$  (AUC): a) Feed; b) Fluidized-bed furnace; c) Electrical heating; d) Sintered metal cone; e) Exterior heating coil for steam and  $\text{H}_2$ ; f) Discharge vessel.

**Continuous plants** usually consist of several fluidized beds. The product is fed by a screw feeder into the first reactor where only partial reduction takes place; the powder then passes over an overflow into the second reactor where reduction is completed. *Moving-bed furnaces*, which are electrically heated cylindrical shafts through which a powder-granular material migrates continuously downward from above, produce a heterogeneous powder because of large temperature gradients in the furnace; these are now seldom used. However,

*rotary kilns* are sometimes employed and, like fluidized-bed furnaces, are in widespread use for other process stages in the thermal treatment of uranium compounds.

### 41.7.4.6 Production of $\text{UF}_4$

Uranium hexafluoride has always been produced on an industrial scale via the intermediate  $\text{UF}_4$ , which is produced in a dry process by reaction of  $\text{UO}_2$  with anhydrous hydrogen fluoride. If  $\text{UO}_3$  is the starting material, it is first reduced to  $\text{UO}_2$ . Uranium hexafluoride is then produced by reaction of  $\text{UF}_4$  with elementary fluorine.

### Hydrofluorination of $\text{UO}_2$

The reaction

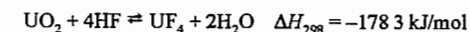

is carried out at  $300\text{--}600^\circ\text{C}$ , depending on the reactivity of the  $\text{UO}_2$  powder and the desired bulk density of the  $\text{UF}_4$  product. Some difficulties are encountered due to the reversible nature of the hydrofluorination reaction and the possibility that eutectic  $\text{UF}_4\text{--UO}_2$  mixtures may be formed that can lead to plastic flow and, hence, sintering at higher temperature. Uranium tetrafluoride always contains a small proportion of  $\text{UO}_2\text{F}_2$  formed from the reaction of uranium trioxide with HF:

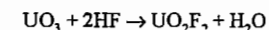

Fluidized-bed furnaces and rotary kilns are generally used to carry out the reaction. The LC reactor, which was developed in France, is of a special type (Figure 41.19), part of which resembles a moving-bed reactor (a) in which granulated uranium trioxide is reduced to uranium dioxide. The latter is then converted to  $\text{UF}_4$  by passing anhydrous hydrogen fluoride over it in the next part of the equipment (d), which has vertical and horizontal sections. The powder flows by gravity through the moving bed and is then propelled forward in the horizontal section by a built-in screw feeder.

### Hydration and Hydrofluorination of $UO_3$

In a process developed by British Nuclear Fuels Limited (the BNFL process) [44], uranyl nitrate solutions are concentrated continuously and denitrated to form  $UO_3$ .

Reduction of  $UO_3$  to  $UO_2$  was formerly carried out in semicontinuous fluidized-bed reactors, and hydrofluorination of  $UO_2$  to  $UF_4$  in batch-operated fluidized-bed reactors. For economic and technical reasons, a change to continuous rotary kilns was made.

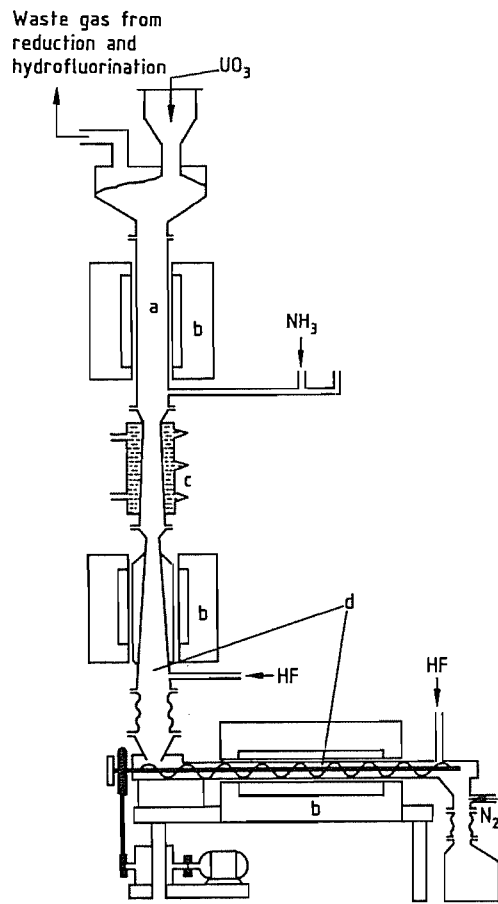

Figure 41.19: LC reactor for  $UF_4$  production: a) Reduction section; b) Heating; c) Cooling; d) Hydrofluorination section.

The so-called UTK process (uranium tetrafluoride in kilns) has three principal stages (Figure 41.20):

- Exothermic hydration:  
 $UO_3 + xH_2O \rightarrow UO_3 \cdot xH_2O$
- Endothermic dehydration and exothermic reduction:  
 $UO_3 \cdot H_2O + H_2 \rightarrow UO_2 + 2H_2O$
- Exothermic hydrofluorination:  
 $UO_2 + 4HF \rightarrow UF_4 + 2H_2O$

Uranium trioxide as produced by denitration in the fluidized bed consists of hard spherical particles with low surface area and inner porosity. To increase both of these parameters and thereby ensure rapid diffusion of the reacting gases,  $UO_3$  is hydrated in jacketed vessels made of special steel. These contain screw feeders that operate intermittently, bringing the powder into contact with metered quantities of steam. Careful control of contact time and temperature ensures that the product is a dry, free-flowing powder.

Hydrated  $UO_3$  powder is reduced in stainless steel rotary kilns (b) containing a system of pushers and retaining rings to give intimate contact with the countercurrent flow of hydrogen. The  $UO_2$  formed is fed pneumatically under nitrogen into the feeder tank (c) of the hydrofluorination stage. The reaction temperature over the entire length of the kiln must be controlled carefully to ensure complete reduction of the product without any decrease in its chemical reactivity during the endothermic dehydration and exothermic reduction. Waste gases leaving the kiln contain nitrogen, steam, and excess hydrogen; they are passed first through filters that remove suspended particles of powder and then through water-cooled condensers and a flame. The gases are then discharged into the atmosphere.

$UO_2$  is converted into  $UF_4$  in a rotary kiln (h) containing similar powder feeding equipment, the material of construction being Inconel. Waste gases (nitrogen and small amounts of excess HF) are filtered and scrubbed with sodium hydroxide solution before being released to the atmosphere. The

$NaF$  solutions produced are treated with hydrated lime.

### 41.7.4.7 Production of $UF_6$ from $UF_4$

#### Process Description

The only processes used on an industrial scale involve the use of elementary fluorine. Uranium tetrafluoride reacts with fluorine according to

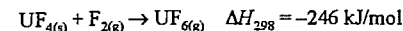

The reaction proceeds fairly rapidly above  $250^\circ\text{C}$ . Reaction temperatures of  $400^\circ\text{C}$  are used for fluorination in fluidized-bed reactors, while name reactors operate at  $1100^\circ\text{C}$ .

If the conversion to  $UF_4$  is incomplete, the product will contain  $UO_2$  and  $UO_2F_2$ , which also react with elementary fluorine. Large amounts of fluorine are consumed in these reactions, so the concentration of these compounds in  $UF_4$  should be kept low. All metallic impurities react to give fluorides in which the metals are at their maximum oxidation states. Nonvolatile fluorides (e.g.,  $AlF_3$ ,  $FeF_3$ , and  $ThF_4$ ) remain behind with unreacted  $UF_4$ ; the volatile compound  $UF_6$  contains volatile fluoride impurities ( $MoF_6$ ,  $VF_6$ ,  $SiF_4$ ,  $CF_4$ ,  $SF_6$ , etc.). These impurities can be removed by dis-

tilling  $UF_6$  and condensing it as a solid. For this, several condensers are used in series. Volatile fluorides of other elements contained as impurities (C, P, Si, B, and S) can be removed without problem during crystallization of  $UF_6$ ; nonvolatile fluorides remain behind as solids at the bottom of the reactor. Most of the  $UF_6$  can be recovered between  $+5$  and  $-15^\circ\text{C}$  in relatively large condensers; the remaining  $UF_6$  is collected in much smaller condensers at ca.  $-50^\circ\text{C}$ . Uranium hexafluoride is then melted out of the filled condensation vessels and collected in storage cylinders.

The heat-exchange surfaces of the condensers consist of nat ribbed plates that are fixed with baffles to the coolant pipes and steam pipes to give good contact. The tubes are U-shaped to reduce thermal stress to a minimum and to enable the condenser contents to be removed easily from the vessel.

#### Chemical Reactors

Fluidized beds can be used for all stages of the process, i.e., the production of  $UO_3$  and its further reaction to  $UO_2$ ,  $UF_4$ , and  $UF_6$ . All of these are gas-solid reactions for which the fluidized-bed reactor is ideally suited, providing rapid mixing of the components and having only small temperature gradients within the bed volume.

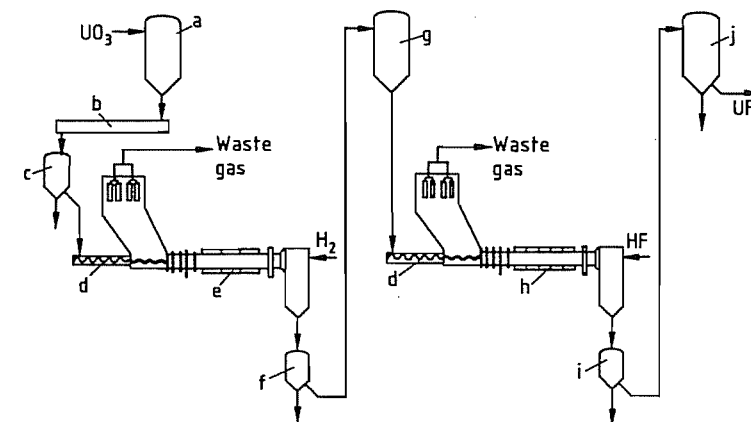

Figure 41.20: Flow diagram of  $UF_6$  production plant in Springfield, United Kingdom: a)  $UO_3$  storage vessel; b)  $UO_3$  hydrator; c)  $UO_3 \cdot H_2O$  storage vessel; d) Screw feeder; e) Rotary kiln for reduction; f)  $UO_2$  intermediate storage vessel; g)  $UO_2$  storage vessel; h) Rotary kiln for hydrofluorination; i) Intermediate storage vessel for  $UF_4$ ; j)  $UF_4$  receiver.

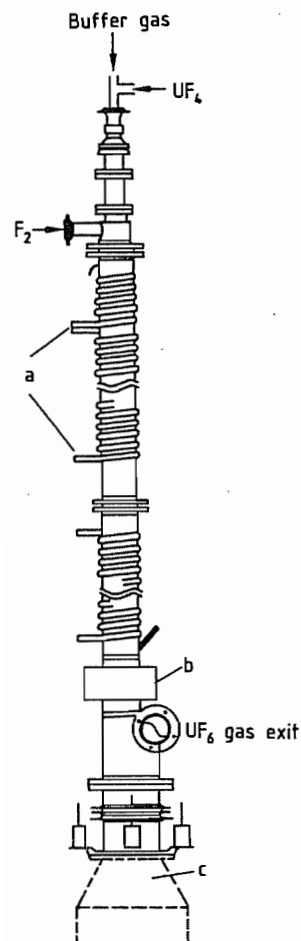

Figure 41.21: Flame reactor for fluorination of  $UF_4$ : a) Cooling coils; b) Expansion compensator; c) Ash receiver.

Flame reactors, developed by Union Carbide Nuclear Corp., are also used. These reactors (Figure 41.21) consist of a vertical Monel tube surrounded by a cooling coil, with a device at the top to give good distribution of  $UF_4$ , which is fed by a screw feeder. Fluorine, which is in excess, is fed through nozzles to the top of the reactor. Reaction of the two components produces a name at ca. 1100 °C inside the reactor. The upper part of the reactor, where most of the reaction occurs, must be cooled to give a wall temperature between 450 and 540 °C. This both minimizes corrosion of

the structural materials and prevents the formation of low-valence uranium fluorides.

#### Removal of Excess Fluorine from $UF_6$

To achieve complete fluorination of uranium, excess fluorine must be used; therefore, excess fluorine will still be present in the reaction gas after it has passed through the condenser. This fluorine comprises ca. 20–40% of the reaction gas and must be removed in an additional chemical reactor. This is similar to the fluorination reactor and operates with an excess of  $UF_4$ . Not only is  $UF_6$  formed, but also lower-valence intermediates such as  $UF_5$ ,  $U_2F_9$ , and  $U_4F_{17}$ .

#### 41.7.4.8 Complete Plant for Production of $UF_6$ from Uranyl Nitrate

##### French Process in Pierrelatte [45]

Uranyl nitrate solution (Figure 41.22) is pumped into a precipitation vessel (a) together with ammonia and water, which react to form ammonium diuranate. Temperature and pH are controlled during precipitation. The precipitate is filtered off by using a vacuum drum filter (b) and is transferred from this to a mixer (c), which converts it into a pumpable slurry by utilizing the thixotropic properties of the material. Ammonium diuranate is calcined to  $UO_3$  in the first rotary kiln (d) and then reduced by a countercurrent flow of hydrogen further down this kiln. Uranium dioxide passes through a seal into a second rotary kiln where hydrofluorination occurs. A third kiln containing a screw feeder completes this reaction. The HF required for fluorination is fed from the exit end of the third rotary kiln in countercurrent flow to the solid. The  $UF_4$  formed is conditioned in drums and then burned in a name reactor (a vertical Monel tube 4.40 m in length) to form  $UF_6$ . The solid by-products  $UF_5$  and  $U_2F_9$ , which are formed in very small quantities, are removed by a screw and recycled to the top of the reactor.

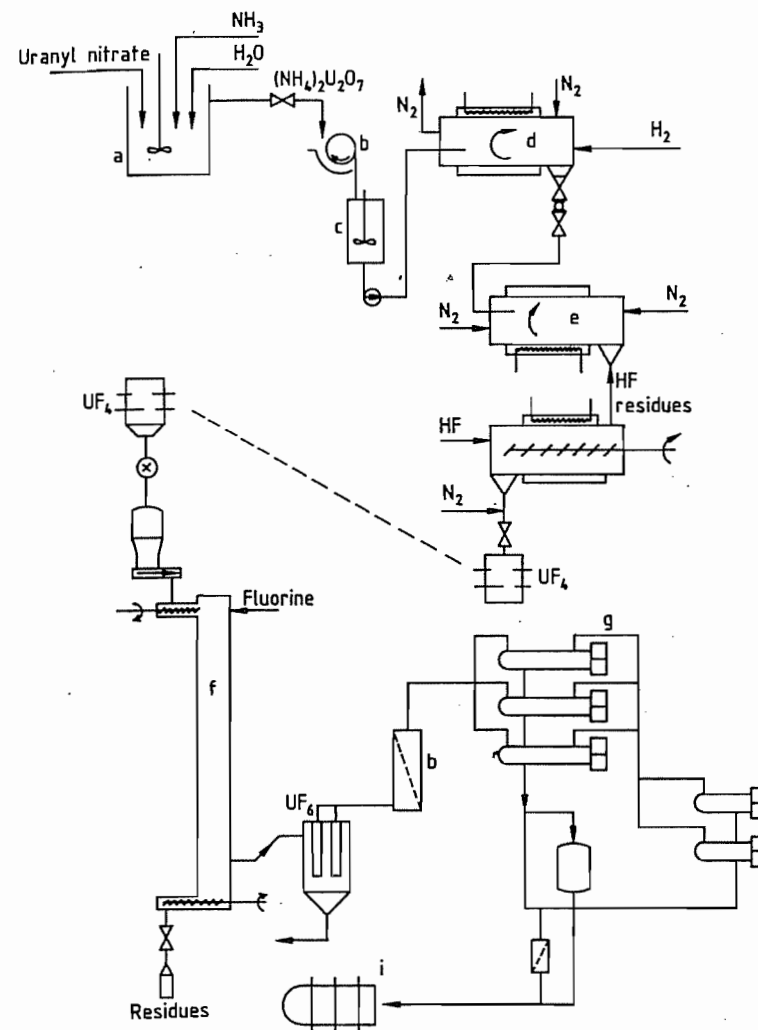

Figure 41.22: French process for  $UF_6$  production: a) Precipitation; b) Filters; c) Mixer; d) Calcination and reduction; e) Hydrofluorination; f) Flame reactor; g) Primary crystallizers; h) Secondary crystallizers; i)  $UF_6$  receiver.

#### Allied Chemical Process

Unlike the processes described above, the Allied Chemical process does not include final purification of uranyl nitrate by liquid–liquid extraction [46]. Instead,  $UF_6$  is purified by distillation [46] at a pressure and temperature above the triple point of  $UF_6$  (64.05 °C at 151.1 kPa). Schematics of  $UF_6$  production and distillation plants are shown in Figures 41.23 and 41.24, respectively.

#### 41.7.4.9 Enrichment of $^{235}U$

Three industrial processes are currently used for enrichment of uranium: the diffusion process, the ultracentrifuge process, and the less important jet nozzle process. Chemical enrichment, laser separation, and the plasma process are used on an experimental or laboratory scale. The three industrial processes employ gaseous  $UF_6$ . Chemical enrichment requires the uranium to be in solution. Two la-

ser separation processes are in competition with each other. Metallic uranium is used in one of these, and gaseous  $UF_6$  in the other. Metallic uranium is used in the plasma process as well.

### Diffusion Process

Separation by diffusion occurs because isotopes diffuse through a semipermeable membrane at different rates owing to the  $\sqrt{m}$  effect. A schematic diagram of the process is given in Figure 41.25 [47]. The separation factor is small (i.e., 1.002–1.004 per stage). Many separation stages (1000–1500) are arranged in series in cascade to give an integral separation

effect. For improved maintenance and ease of replacement, 5, 8, 10, 16, or 20 separation cells are combined as a module. The heavier fraction (depleted in  $^{235}U$ ) that did not diffuse goes back to the previous stage. The heart of the separation cell is the diffusion membrane, which usually has a tubular shape. Diffusion is accelerated by a concentration difference between the outside and the inside induced by a pressure. The pressure difference is 1–10 kPa, depending on the membrane material, and the operating pressure in a cell is 10–30 kPa. Many materials have been tested as membrane materials, including Au, Ag, Ni, Al, Cu, Monel, Teflon, and  $Al_2O_3$ .

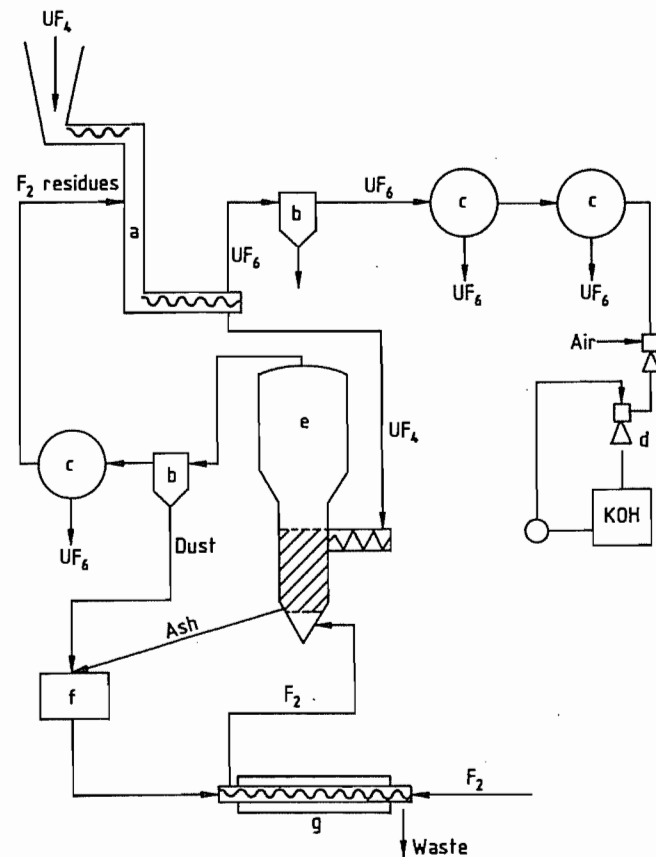

Figure 41.23: Flow diagram of an Allied Chemical  $UF_6$  production plant: a) Tower reactor; b) Filter; c) Condenser; d) Scrubber; e) Fluorinator; f) Mill; g) Ash treatment.

Details of membranes are kept secret. They must be as thin as possible and have a pore size of 10 nm, but they must also have sufficient mechanical stability to withstand the pressure difference for years. One method of producing pores is to dissolve out a component of alloy foils (Ag–Zn, Au–Ag) selectively.  $Al_2O_3$  membranes are produced from aluminum foil (13–30  $\mu m$  thick) by anodically oxidizing it to completion in 5–10% sulfuric acid and then heat treating at 500–530  $^{\circ}C$ . Water is evolved, and a porous membrane is formed with a permeability of ca.  $0.1 \text{ cm}^3 \text{ cm}^{-2} \text{ s}^{-1}$ . In the EURODIF plant in Tricastin, France, diffusers (diffusion cells) and compressors have been joined to form a single unit. The main disadvantage of the diffusion process is the high energy requirement for the work of compression. For example, the EURODIF plant, which provides 10 800 t USW/a (tonnes of uranium separative work per year), requires ca. 3000 MW electric power, for which four nuclear power stations, each of 925 MW capacity, have been constructed [48].

### Ultracentrifuges

In 1942, P. HARTECK and W. GROTH first used centrifuge technology to separate uranium isotopes. The countercurrent centrifuge is illustrated in Figure 41.26 [47]. The separation factor of 1.2 formerly achieved has now been increased to 1.5 in modern equipment of this type. In Germany in 1970, a trilateral centrifuge project among the United Kingdom, The Netherlands, and West Germany was inaugurated (foundation of URENCO), and construction of three plants each with an enrichment capacity of 200 t USW/a was agreed upon. The German and Dutch plants are in Gronau, Lower Saxony, and Almelo, The Netherlands, respectively; the British plant is in Capenhurst, United Kingdom. Over the long period of operation, 99% plant availability has been achieved [49]. Ultracentrifuge plants of capacity > 100 t USW/a are competitive with diffusion plants and have two important advantages:

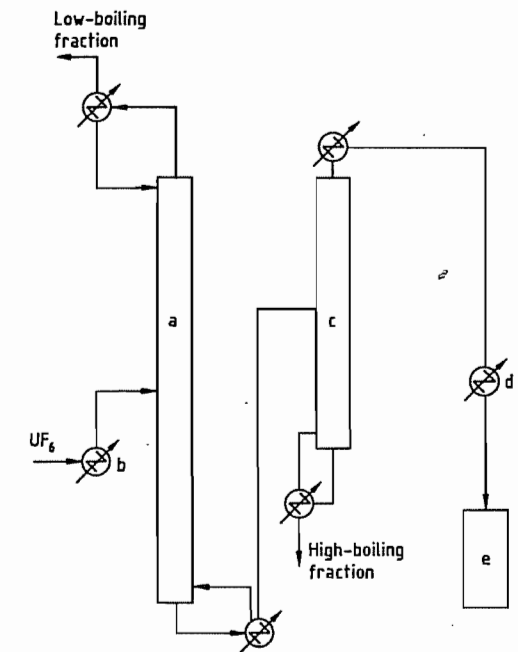

Figure 41.24: Flow diagram of the fine purification of  $UF_6$  by the Allied Chemical process: a) Column I for low-boiling fraction; b) Evaporator; c) Column II for high-boiling fraction; d)  $UF_6$  cooler; e)  $UF_6$  receiver.

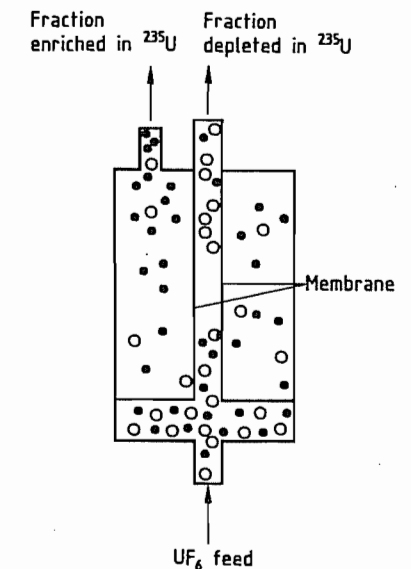

Figure 41.25: Schematic of a diffusion cell [47].

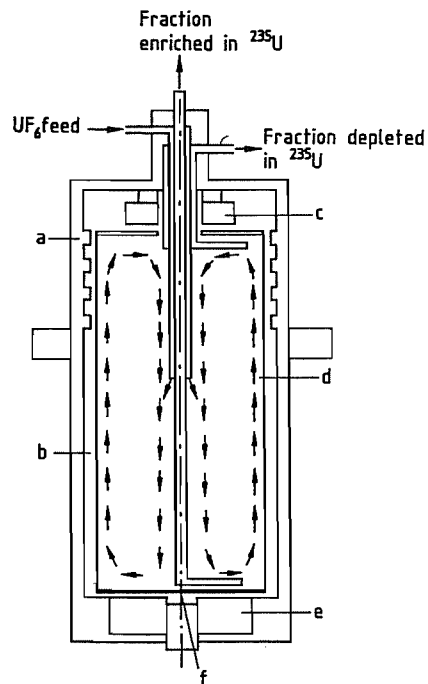

Figure 41.26: Cross section of a centrifuge [47]: a) Housing; b) Vacuum; c) Magnetic holding device; d) Rotor; e) Electrical drive; f) Needle bearing.

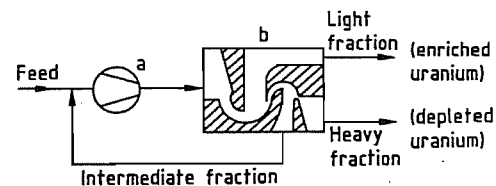

Figure 41.27: Schematic of the Brazilian nozzle separation system [47]: a) Compressor; b) Double deflecting system.

- The specific energy consumption using the centrifuge technique is 200 kWh/kg USW.
- The cascade for a low degree of enrichment (e.g., for light-water reactors) has only 15–20 separation stages, but diffusion equipment requires 1200 stages (EURODIF). A plant using the ultracentrifuge technique can be extended easily by the modular method using parallel connections.

## Nozzle Process

This process, which was developed by E. W. BECKER in Karlsruhe, is the only one to which secrecy restrictions do not apply [50]. A modern nozzle with dimensional data is described [51]. The separation effect is improved by addition of a light gas. The nozzle principle is illustrated in Figure 41.27 [47].

A mixture of 4% gaseous  $UF_6$  and 96% of a light carrier gas (e.g.,  $H_2$  or  $He$ ) is expanded in the first jet. Due to the flow deflection in the carrier stream the heavier uranium isotopes become enriched in the outer flow region. Subsequently the outer flow region is separated by specially designed separation geometry from the inner flow region. The second jet works similar and is used to improve the efficiency of the stage.

The production of enriched uranium for light-water reactors requires several hundred stages in a cascade; i.e., the separation effect (0.015–1.026) is better than that obtained by the diffusion process and worse than that obtained by ultracentrifugation. The energy requirement is comparable to that of the diffusion process since high energies of compression are required. The process is operated on an industrial scale in Brazil and South Africa (the Helikon process).

## Chemical Enrichment

The principle of chemical enrichment is based on the fact that in some chemical exchange processes (e.g.,  $UX + Y \rightleftharpoons UY + X$ ), different uranium isotopes have different tendencies to bond to substances X and Y. This mechanism is based on small differences in the preferred mean oxidation states of the particular isotopes in the given reaction environment. For industrial operation, the reaction must be rapid; the separation factor for the reaction must be acceptable; and the reverse reaction must occur readily. A pilot plant in operation in Japan [52] depends in principle on the equilibrium between  $U^{4+}$  and  $UO_2^{2+}$  in aqueous solution in the presence of an ion-exchange material. In this environment, the pre-

ferred valence of  $^{238}U$  is 4 and that of  $^{235}U$  is 6. The ion-exchange material has no preference for either isotope, but it preferably adsorbs hexavalent uranium isotopes. So the overall effect is a slight increase in  $^{235}U$  concentration. Since the enrichment factor is very small (1.001 to 1.0014), many stages in the sequence are necessary. The integration of many stages into a continuously operating column was achieved in the pilot plant with the development of the self-generation reaction (Adox reaction) between the deactivated redox agents. A regeneration of ca. 70% is achieved in a semi-commercial plant. Figure 41.28 shows a schematic diagram of the plant.

In the column the zones are migrating continuously from top to bottom. In the adsorption zone the ion exchanger is loaded with  $^{235}U$ . If the adsorption zone arrives at the valve, the adsorber is removed together with enriched uranium. The acceptor zone contains the depleted uranium. Uranium and regenerated ion exchanger material are introduced at the donor zone. The redox agents are regenerated in the adox boundary zone. Hydrogen and oxygen are fed in the area of the valve to complete regeneration of the redox agent.

In France, the equilibrium between  $U^{3+}$  and  $U^{4+}$  is utilized [53]. Separation occurs between an aqueous hydrochloric acid phase retaining trivalent  $^{238}U$  and the phase of an organophosphorus compound, retaining  $^{235}UCl_4$ . The enrichment factor is ca. 1.025. This process also requires several thousand stages.

## Laser Separation Process

Laser separation of isotopes is based on the fact that small differences exist between the absorption spectra of  $^{235}U$  and  $^{238}U$ . By using lasers of suitable wavelength, one isotope can be excited selectively. Two methods have been investigated, in one of which selective excitation is applied to uranium metal vapor, and in the other to gaseous  $UF_6$ . The first of these is known as the Atomic Vapor Laser Isotope Separation (AVLIS) process. Here, the selectively excited uranium atom is ionized and then separated electrostatically from the

stream of metal vapor [54]. In the Molecular Laser Isotope Separation (MLIS) process, selectively excited  $UF_6$  molecules dissociate into  $UF_5$  and F. Fluorine must be bonded rapidly to suppress the reverse reaction. The  $UF_5$  can then be separated from the stream of molecules [54]. Both processes require several stages despite the high separation factor. The AVLIS process is currently regarded as the most promising because the sequence of stages can be put together without problems. However, in the MLIS process,  $UF_5$  must be converted back to  $UF_6$  after each stage [54]. For this reason, research in the United States was formerly concentrated on the AVLIS process.

Two possible methods of incorporating the AVLIS process into the series of operations to convert uranium ore into nuclear fuel are illustrated in Figure 41.29.

## Plasma Processes

Two effects suitable for isotope separation are under investigation.

The first utilizes the fact that uranium plasmas rotating in magnetic fields achieve considerably higher rotational speeds than those produced by a centrifuge. Thus, uranium isotopes can be separated by gravity. The second effect utilizes that in a homogeneous magnetic field the cyclotron frequency of the ions in the plasma depends only on magnetic field strength and ionic mass. Hence, the isotopes have different circulation paths in the cyclotron. Thus, isotopes are separated in a rotating plasma and collected separately by different collecting devices.

### 41.7.4.10 Production of $UO_2$ Pellets from $UF_6$

#### Conversion of $UF_6$ to $UO_2$

The industrially important processes for producing  $UO_2$  pellets from  $UF_6$  may be divided into wet and dry processes.

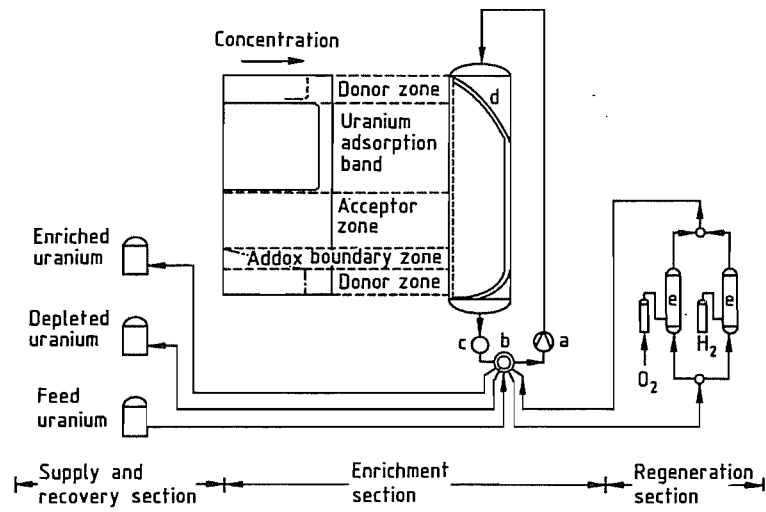

Figure 41.28: Schematic of the Japanese chemical enrichment plant: a) Pump; b) Valve; c) Detector; d) Enrichment column; e) Regeneration reactors.

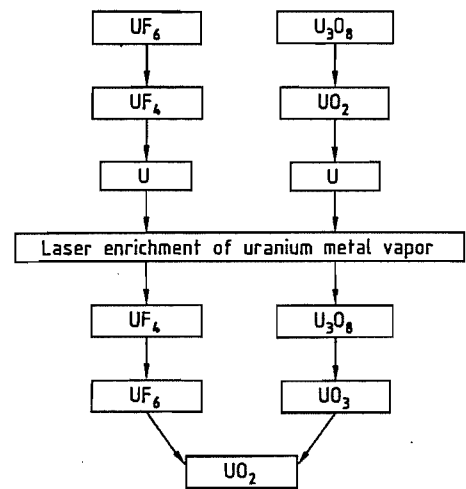
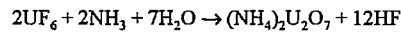

Figure 41.29: Example of incorporation of the AVLIS process into the chemical process chain of fuel element production.

**Wet Processes.** Wet processes include the precipitation of ADU and AUC, as described in Section 41.7.4.5 for obtaining UO<sub>2</sub> from high-purity uranyl nitrate. The apparatus for converting UF<sub>6</sub> to UO<sub>2</sub> is illustrated in Figures 41.30 and 41.31. The difference from the processes described in Section 41.7.4.5 is that the starting material is UF<sub>6</sub>. The following two reactions occur:

ADU process



AUC process

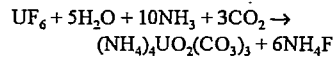

Subsequent conversion of ammonium diuranate or ammonium uranyl carbonate to UO<sub>2</sub> powder is carried out by methods similar to those already described. However, since conditions in the calcination stage significantly affect the properties of the powder for later finishing operations, properties are optimized by controlling those conditions.

**Dry Processes.** Reaction equations for dry processes are given below in simplified form:

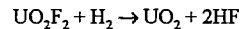
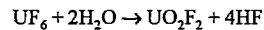

However, these dry processes vary considerably with respect to processing details and design of the chemical reactors. In the older processes, up to four separate reaction chambers were required, whereas modern processes use one or at most two reaction chambers. A schematic diagram of the Direct Conversion (DC) process is given in Figure 41.32. Construction materials must be chosen very carefully because of the corrosive properties of the

hot, gaseous hydrofluoric acid produced. However, satisfactory experience with this plant shows that reliable solutions to these problems have now been achieved by materials technology.

*Possible Future Developments in the Conversion of UF<sub>6</sub> to UO<sub>2</sub> Powder*

The wet ADU and AUC processes are used worldwide to convert UF<sub>6</sub> to UO<sub>2</sub> powder for the production of nuclear fuel pellets for light-water reactors. The combination of processes has been optimized within the limits of process parameters to enable the pellets to be pro-

duced economically and in accordance with quality specifications. The standards established are applicable to all later production developments, especially the dry conversion processes.

However, assessment of the wet processes shows that the following fundamental improvements are desirable:

- Avoidance of open-air handling of the powder in all process steps
- Reduction of radioactive secondary waste when treating process waste and purifying process materials from uranium

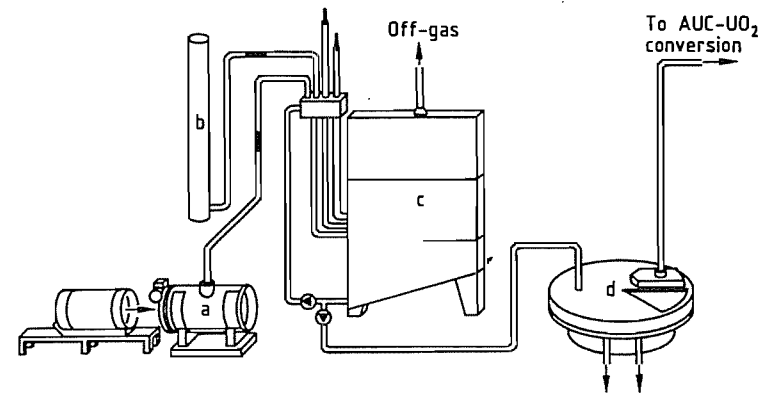

Figure 41.30: Conversion of UF<sub>6</sub> into AUC: a) UF<sub>6</sub> evaporation; b) NH<sub>3</sub>, CO<sub>2</sub> supply; c) Reaction tank; d) Rotating filter for AUC collection.

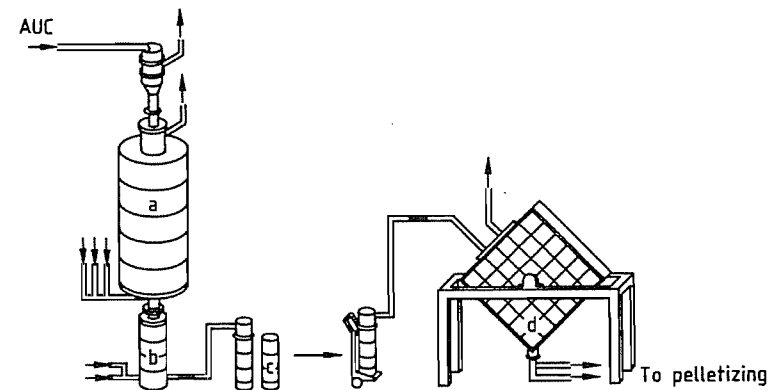

Figure 41.31: Conversion of AUC into UO<sub>2</sub> powder: a) Fluidized bed; b) Stabilization; c) Storage container; d) Homogenizer.

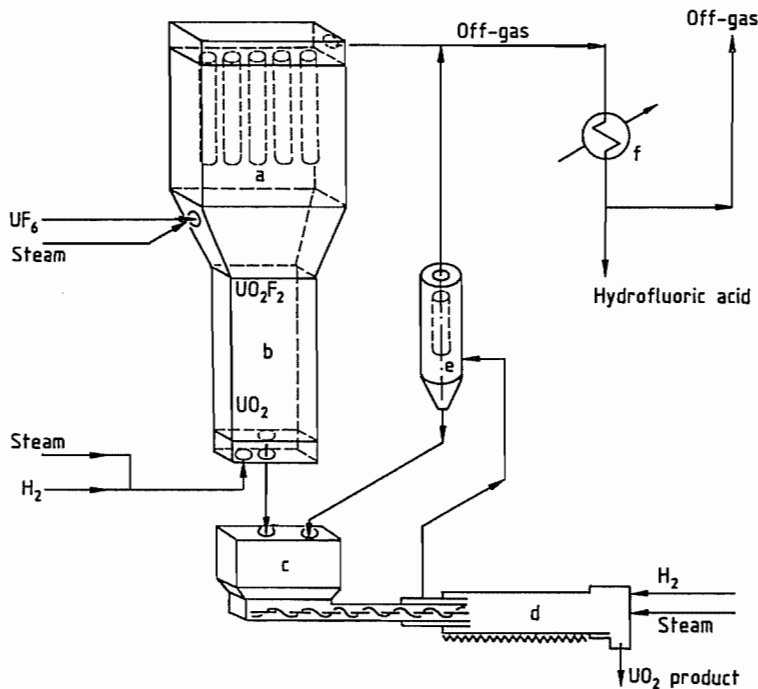

Figure 41.32: Schematic of Direct Conversion process: a) Reactor; b) Fluidized bed; c) Feed bin; d) Rotary kiln; e) Filter; f) Condenser.

**Future Processes.** In the production of  $UO_2$  pellets, intermediate products in powder form can of course be avoided only by using *wet processes*. A possible approach is to use the sol-gel process [55–57] in which  $UF_6$  is dissolved in aqueous uranyl nitrate solution and mixed with poly(vinyl alcohol). This solution is then sprayed into a second liquid with a very different surface tension, and ammonia is added. This causes hardening of the droplets to form particles, which are then washed in aqueous  $NH_3$  solution to remove the undesired by-product  $NH_4NO_3$ . A calcination process in air then decomposes the poly(vinyl alcohol) and the ammonium diuranate to  $UO_2$ . The solid particles obtained can then be compressed directly into pellets. The process is carried out in such a way that the  $UO_2$  pellets are of similar quality and have similar properties to those produced by conventional processes.

However, analysis of this process shows that the many washing and purification steps

and the considerable volume of materials used lead to a large volume of process and waste materials that must be cleaned and disposed of. Although very little dust is produced, the cost of cleaning and waste disposal is high. For this reason, the main interest in process development has now reverted to *dry processes* such as IDR, DC, and GECO, the industrial handling of dusts and aerosols having meanwhile been greatly improved.

All these processes convert  $UF_6$  to  $UO_2$  by the following reactions

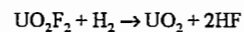
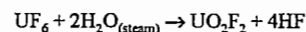

These two reaction steps can be combined in one process as realized by the BNFL IDR process. Siemens prefers a two-step procedure. In a flame reactor  $UO_2$  is formed together with minor amounts of  $UO_2F_2$ . In a subsequent rotary kiln the  $UO_2$ - $UO_2F_2$  mixture is converted to  $UO_2$ , which contains negligible impurities of fluorine. A common

feature of all processes is to provide a  $UO_2$  powder with an acceptable sinterability and a low F content. Reducing the fluorine content requires a hydrogen treatment at higher temperature (500–800 °C), which results in an optimization of fluorine depletion and sinterability.

Table 41.10: Treatment of processing materials and residues in the AUC process (simplified).

Process step	Residual material <sup>a</sup>	Treatment	Disposal route
Precipitation	g: $NH_3$ g: $CO_2$	Waste-gas scrubbing	Stack
Filtration	l: $NH_4F$ l: $H_2O$ l: U (traces) l: Other activity	Peroxide precipitation Lime precipitation	Utilization
Washing	l: $(NH_4)_2CO_3$ l: $H_2O$ l: U (traces)	ADU precipitation	Wastewater
AUC feed (AUC → $UO_{2+x}$ )	g: $NH_3$ g: $CO_2$ g: $H_2O$	Waste-gas scrubbing	Stack
Calcination	g: $H_2$ g: $H_2O$ g: HF		

<sup>a</sup> g = gaseous phase; l = liquid phase.

**Chemicals and Residues in the AUC and DC Processes.** Table 41.10 shows how the treatment (not presented in detail here) of processing chemicals and residues is integrated in such a way that it is compatible with the main process of  $UF_6 \rightarrow UO_2$  conversion. Material flows are suitably interlinked to minimize consumption of raw materials and processing chemicals, and to recycle usable materials. At the same time, individual process steps must be optimized continuously to ensure compliance with steadily decreasing pollution limits.

In the *DC process*, the processing materials are steam,  $H_2$ , and  $N_2$ . In addition, HF is formed in amounts corresponding to the amounts of  $UF_6$  treated. Gas streams passing from the reaction vessels are filtered several times to remove solids. After condensation of HF, the gas is recycled as far as possible for use as a processing material. Residual gas is passed over  $CaCO_3$  to remove HF completely, the traces of HF reacting to form  $CaF_2$ . The gas so obtained is flared off to remove  $H_2$ , and

the waste-gas stream can be released from a stack since it contains only residual  $H_2$  and  $H_2O$ . Fluorine introduced into the process in the form of  $UF_6$  can be reused in the form of pure hydrofluoric acid. The small amounts of  $CaF_2$  in  $CaCO_3$  can be dumped without further treatment.

A comparison of the aqueous AUC process and the dry DC process shows that for the same product quality, the dry process has considerable advantages in the treatment of processing and waste materials. The DC process is consequently growing in importance, which shows how ongoing efforts to reduce pollution can also lead to process rationalization.

### Pelletizing of $UO_2$ Powder

Some processes require preparation of the powder by compaction and granulation. When the AUC process is used, the  $UO_2$  powder obtained can be compressed and sintered without any intermediate steps.

### 41.7.4.11 Production of Uranium Metal

The requirement for uranium metal is limited. Only Magnox reactors for power generation require uranium metal as fuel. Uranium metal is also needed for the production of U-Zr, U-Zr hydride, uranium silicide, and uranium-aluminum alloys. If laser enrichment processes such as the AVLIS process attain industrial importance, the requirement for elementary uranium will increase. Uranium metal is produced from  $UF_6$  by a two-stage reduction; the intermediate product is  $UF_4$ .

#### Reduction of $UF_6$ to $UF_4$

Two principal routes are used:

- Reduction of  $UF_6$  by  $H_2$  in the gas phase
- Reduction of  $UF_6$  with chlorinated hydrocarbons (mainly unsaturated)

**Reduction with Hydrogen.** The throughput and degree of enrichment required are important considerations when selecting a process. Reduction of  $UF_6$  by hydrogen in so-called



hot-wall and cold-wall reactors was reported at the Geneva Conference of 1958 [58]. The reaction is exothermic:



The heat of this reaction is not sufficient to give quantitative conversion. The *hot-wall reactor* is therefore provided with external heating to give a wall temperature of 630 °C. The *cold-wall reactor* obtains its energy from the highly exothermic reaction of fluorine (mixed directly with  $\text{UF}_6$ ) with excess hydrogen.

**Reduction with Tetrachloroethylene.** Reaction of  $\text{UF}_6$  with tetrachloroethylene ( $\text{C}_2\text{Cl}_4$ ) in a fluidized-bed furnace was developed by United Nuclear Corp. [59]:

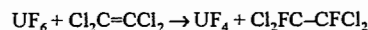

The reaction temperature is 260–295 °C. Nitrogen is added to tetrachloroethylene to act as a carrier gas.

### Reduction of $\text{UF}_4$ to Uranium Metal

Calcium, magnesium, and sodium are thermodynamically suitable agents for the reduction of  $\text{UF}_4$  to uranium metal, but only calcium and magnesium are of practical importance—calcium for small batches because of its higher heat of reaction, and magnesium for larger quantities because it is the cheaper metal.

**Reduction with Calcium.** The heat of reaction of reduction with calcium is very large:

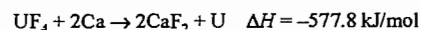

With a calcium excess of 15% and adiabatic conditions during reduction, the temperature of the reaction mixture can rise to 1800 °C. This temperature is high enough to melt the slag formed (*mp* of  $\text{CaF}_2$  1418 °C). Calcium granules (ca. 5 mm) are used, which must be very pure. High magnesium content may cause a violent reaction because the reaction temperature is higher than the boiling point of magnesium.

A mixture of  $\text{UF}_4$  and calcium is charged into a steel reaction vessel whose inner walls are lined with high-purity  $\text{CaF}_2$  (Figure 41.33). This interior lining prevents the container material from reacting with molten ura-

nium metal. Before reduction, the reaction apparatus is evacuated and filled with argon. The reaction mixture is then ignited electrically with an ignition pellet, and the reaction is complete after a few seconds. Molten uranium collects at the bottom of the reaction vessel and can be separated easily from the slag after the vessel is cooled. The yield of metal is ca. 98–99% of theory.

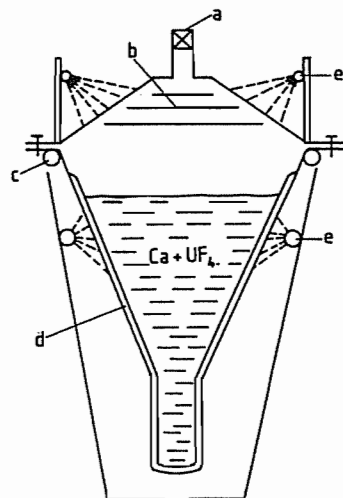

**Figure 41.33:** Reactor for reduction of  $\text{UF}_4$  with calcium: a) Pressure control valve; b) Heat protection shields; c) Circular water pipe for flange cooling; d)  $\text{CaF}_2$  lining; e) Circular pipe for water jets.

**Reduction with Magnesium.** Uranium reduction on a larger scale (several hundred kilograms of metal) is usually carried out with the much cheaper magnesium. Also, since its relative atomic mass is only about half that of calcium, the amount of magnesium required is smaller. However, the price advantage is counterbalanced partly by the lower heat of reaction:

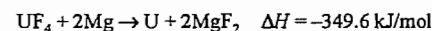

which makes it necessary to heat the reaction mixture to ca. 600 °C. If the mixture is at room temperature when it is ignited, the melting point of uranium metal and of the  $\text{MgF}_2$  slag (1263 °C) is not reached. By using an excess of 15% magnesium, the temperature reached is only ca. 900 °C under adiabatic conditions.

The interior walls of the reactor are often lined with dolomite. To obtain a good yield, the bulk density of  $\text{UF}_4$  must be relatively high ( $> 3 \text{ g/cm}^3$ ), giving good thermal conductivity. Briquetting the reaction mixture before loading it into the reactor vessel is therefore advantageous.

### Production of Uranium Powder

Uranium powder can be obtained by reduction of  $\text{UO}_2$ , electrolysis of fused salts, or decomposition of uranium hydride.

**Reduction of  $\text{UO}_2$ .** Reduction of  $\text{UO}_2$  with calcium or magnesium has not become widely established in industry because separation of the product from the slag is difficult. Also, the demand for uranium powder is limited.

**Reduction with Calcium.** The best reducing agent for  $\text{UO}_2$  is calcium. A carefully prepared mixture of calcium granules and  $\text{UO}_2$  is charged to a reactor whose walls are lined with  $\text{CaO}$ . The mixture is heated to 1200 °C under argon and kept at this temperature for at least 30 min. The temperature should reach the melting point of uranium (1132 °C) but should not cause  $\text{CaO}$  to melt. The uranium particles therefore become embedded in unmelted  $\text{CaO}$ . Excess calcium, which has low solubility in  $\text{CaO}$ , acts as a grain growth accelerator of the uranium.

After reaction, the mixture, which contains uranium and  $\text{CaO}$  together with excess calcium, is broken up and slurried with water. After careful addition of acetic acid (to buffer the solution at pH 5.5 by formation of calcium acetate), dilute nitric acid is added to leach out calcium. A temperature of 30 °C should not be exceeded in this leaching process because higher temperatures cause oxidation of the surface of the metal powder.

**Reduction with Magnesium.** The temperature during reduction with magnesium must be kept below 1270 °C; however, it should be above 1133 °C, which is higher than the *bp* of magnesium, so that large enough metal particles will be formed. The metal powder produced by reduction with magnesium is much finer than that obtained by reduction with cal-

cium. Magnesium chloride is often added to the reaction mixture to act as a flux.

**Electrolysis of Fused Salts.** The electrowinning of metal powder is carried out in fused fluoride or chloride salts.  $\text{KUF}_5$  or  $\text{UF}_4$  is dissolved in a molten salt mixture of 80%  $\text{CaCl}_2$  and 20%  $\text{NaCl}$ , and electrolyzed at 900 °C in a graphite crucible, which forms the anode. When withdrawing the cathode from the molten salt, appropriate precautions must be taken to prevent burning of powdered metal that adheres to it. After cooling, soluble chlorides can be removed from the metal by washing with water.

**Decomposition of Uranium Hydride.** Hydrogen reacts very readily with uranium metal, forming uranium hydride ( $\text{UH}_3$ ). The optimum hydrogenation temperature is 220 °C. Because of the large density difference between the hydride (10.8  $\text{g/cm}^3$ ) and the metal (19.06  $\text{g/cm}^3$ ), the brittle hydride breaks down during the reaction into a fine pyrophoric powder. This is decomposed thermally at 310 °C with application of a vacuum to draw off hydrogen. The metal powder so obtained is strongly pyrophoric and can be handled only under an inert gas atmosphere.

## 41.8 Compounds

### 41.8.1 Halides

The most important halides (Table 41.11) are the fluorides; polymers such as  $\text{U}_4\text{F}_{17}$  and  $\text{U}_5\text{F}_{22}$  are not included in this table because they have little technical importance.

#### 41.8.1.1 Trivalent Halides

In general, trivalent halides may be prepared by reduction of the tetravalent compounds with hydrogen, e.g., [60]:

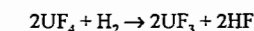

At 950 °C all of the  $\text{UF}_4$  does not react; above 1080 °C, disproportionation of  $\text{UF}_3$  into  $\text{UF}_4$  and uranium occurs. Preparation of chlorides, bromides, and iodides involves similar problems.

**Table 41.11:** Halogen compounds of uranium (excluding polymeric compounds).

		Structure
Fluorides	UF <sub>3</sub>	hexagonal, LaF <sub>3</sub> type
	UF <sub>4</sub>	triclinic (pseudomonoclinic), isomorphous with ThF <sub>4</sub>
	U <sub>2</sub> F <sub>9</sub>	cubic
	α-UF <sub>5</sub>	tetragonal, chain structure
	β-UF <sub>5</sub>	tetragonal, three-dimensional lattice
	UF <sub>6</sub>	rhombic, molecular lattice
Chlorides	UCl <sub>3</sub>	hexagonal, La(OH) <sub>3</sub> type
	UCl <sub>4</sub>	tetragonal
	UCl <sub>6</sub>	hexagonal, molecular lattice
Bromides and iodides	UBr <sub>3</sub>	hexagonal, La(OH) <sub>3</sub> type
	UI <sub>3</sub>	rhombic, LaI <sub>3</sub> type

**Uranium trifluoride**, UF<sub>3</sub>, forms red-violet crystals. It is stable to moist air at room temperature, but is converted to oxide fluorides on heating and is oxidized to U<sub>3</sub>O<sub>8</sub> above 900 °C. It is insoluble in cold water but is slowly oxidized to uranyl fluoride in boiling water, further oxidation to uranyl fluoride occurs.

**Uranium trichloride**, UCl<sub>3</sub>, forms dark red, very hygroscopic needles, *mp* 842 °C. In aqueous HCl solution, rapid transformation into a tetravalent green compound occurs, with liberation of hydrogen according to:

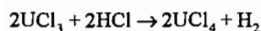

**Uranium Tribromide and Triiodide.** Uranium tribromide, UBr<sub>3</sub>, *mp* 730 °C, and uranium triiodide, UI<sub>3</sub>, *mp* 506 °C, are formed similarly to UF<sub>3</sub>, and are also soluble in water.

#### 41.8.1.2 Uranium Tetrahalides

Uranium tetrafluoride is a very important intermediate in the production of UF<sub>6</sub> for enrichment plants (see Section 41.7.2) and for production of the metal. It is a highly polymeric green solid that melts at 1034 [61] to 1036 °C [62]. Gaseous UF<sub>4</sub> is monomeric. The stability of solid UF<sub>4</sub> is explained by its complex crystal lattice (α-ZrF<sub>4</sub> structure). However, oxidation occurs in a stream of oxygen at 700–850 °C:

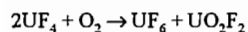

Uranium tetrafluoride is almost insoluble in water and is dissolved only by oxidizing acids and some concentrated acids.

*Hydrated UF<sub>4</sub>* can also be prepared by precipitation from U(IV) solutions with hydrofluoric acid. At room temperature, the very pale green UF<sub>4</sub>·2.5H<sub>2</sub>O [63] is formed, but at 80–100 °C the grass green compound UF<sub>4</sub>·0.75H<sub>2</sub>O is obtained. Both can be converted into anhydrous UF<sub>4</sub> by careful dehydration in a vacuum.

**Other Halides.** Uranium tetrachloride (*mp* 569 °C), UBr<sub>4</sub> (*mp* 518 °C), and UI<sub>4</sub> (*mp* 706 °C) can be produced by heating a mixture of uranium oxides and carbon in a stream of halogen. Uranium tetrachloride dissolves very readily in water, with evolution of heat; UBr<sub>4</sub> and UI<sub>4</sub> behave similarly.

#### 41.8.1.3 Uranium Pentafluoride

The reaction of UF<sub>4</sub> with UF<sub>6</sub> produces UF<sub>5</sub>, which is formed together with U<sub>2</sub>F<sub>9</sub> and U<sub>4</sub>F<sub>17</sub> as an intermediate in the production of UF<sub>6</sub> (see Section 41.7.4.7). UF<sub>5</sub> is now also important as an intermediate product formed during uranium enrichment using lasers (see Section 41.7.4.9). Other pentahalides are known but are of only theoretical interest.

#### 41.8.1.4 Uranium Hexafluoride

Many possible methods can be used to produce UF<sub>6</sub>, the more important are listed below:

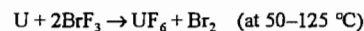
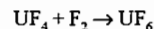
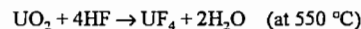
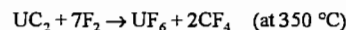
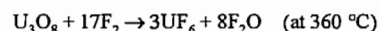
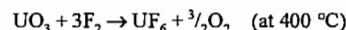
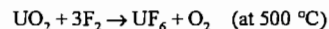
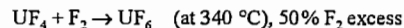
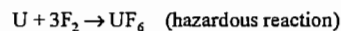

The only industrial route is from pure UF<sub>4</sub>. The phase diagram of UF<sub>6</sub> is shown in Figure 41.34. At normal pressure, UF<sub>6</sub> sublimates at

56.54 °C and melts only under a pressure of  $1.517 \times 10^5$  Pa at 64.05 °C.

The critical constants for UF<sub>6</sub> are [64] – *T<sub>c</sub>*, 230.5 ± 0.2 °C; *p<sub>c</sub>*, (45.50 ± 0.50) × 10<sup>5</sup> Pa; *p<sub>c</sub>*, 1.375 g/m<sup>3</sup>; *V<sub>c</sub>*, 0.256 L/mol.

Solid UF<sub>6</sub> has similarities to white phosphorus, having a colorless to yellowish appearance and being easily cut into pieces. However, in contrast to phosphorus, it reacts rapidly with moisture, hydrolyzing even in moist air to form the bluish compound UO<sub>2</sub>F<sub>2</sub>, which resembles cigarette smoke:

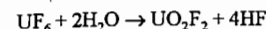

This fine bluish smoke enables the smallest UF<sub>6</sub> leak in pipework to be detected immediately. At increased temperatures, UF<sub>6</sub> gas reacts violently or explosively with organic substances, but metal and glass are not attacked in the absence of moisture. Comprehensive data on UF<sub>6</sub> can be found in [64].

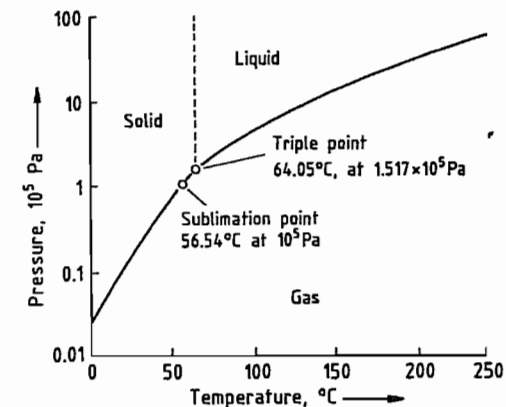
Figure 41.34: Phase diagram of UF<sub>6</sub> [64].

#### 41.8.2 Carbides

The three carbides UC, U<sub>2</sub>C<sub>3</sub>, and UC<sub>2</sub> appear in the U–C phase diagram [65]. Both UC and UC<sub>2</sub> are stable up to their melting points; U<sub>2</sub>C<sub>3</sub> is an intermediate phase that disproportionates above 1800 °C into UC and UC<sub>2</sub> [66]. The carbide UC<sub>2</sub> is unstable below 1275–1500 °C, disproportionating to form U<sub>2</sub>C<sub>3</sub> and carbon [67]. Above 1800 °C, UC<sub>2</sub> has the composition U/C = 1.86 ± 0.02 (atomic ratio) and a cubic structure, whereas a tetragonal

form exists between 1600 and 1800 °C with composition U/C = 1.96 ± 0.04. Various temperatures are quoted for the melting point. According to [68], the *mp* of UC is ca. 2350 °C, and that of UC<sub>2</sub> with the composition U/C = 1.9 is 2475 °C.

The carbides react very vigorously with water, and are therefore not used in water-cooled nuclear reactors because secondary damage could occur in the event of a defective fuel rod. However, they can be used as nuclear fuel if cooling is by gas or sodium, two generations of reactors that could be important in the future. Carbide fuels are therefore not yet available on the market except for testing purposes. In experimental fuel elements, UC is used mainly in the form of pellets, rods, or coated particles.

Uranium carbide is produced by three main methods:

#### Reaction of Uranium Metal with Carbon.

Stoichiometric UC is obtained when a mixture of uranium powder with carbon is compressed at 800–1000 °C [69]. The material so produced has a density of 98% of the theoretical value and a Vickers hardness of 700 kg/mm<sup>2</sup>, a figure normally only obtainable with UC sintered at 2000 °C. A somewhat lower-density UC is formed by compressing uranium powder with carbon at 700–800 °C and then sintering the pellets at 1100 °C [70].

Very pure and dense UC is obtained by arc melting of uranium and carbon under vacuum or argon. This method gives densities of 98–99.5% of theory [71].

#### Reaction of Uranium Metal with Alkanes.

Very fine uranium powder (produced by decomposition of uranium hydride) is reacted with methane at 600–900 °C to give very pure and dense UC [72]. Reaction times are 0.5–2 h. Propane has also been used successfully.

**Reaction of Uranium Oxides with Carbon.** This is the only reaction of industrial importance. The following reactions can occur:

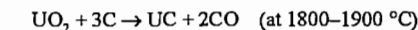
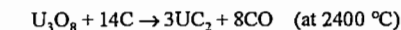
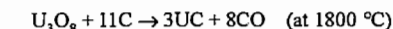

Nuclear fuels are produced by this method in a vacuum furnace or under a protective gas since UC is pyrophoric.

**Production of UC Fuel Rods.** Uranium carbide rods are produced by melting UC at ca. 2500 °C and casting in rod-shaped molds [73]. Of the possible melting processes (i.e., electron beam melting, induction melting, and arc melting), only the last has been developed to an industrial scale. Induction melting is particularly unsuitable because reaction with the walls of the graphite crucible occurs, converting UC to UC<sub>2</sub>.

The process of melting UC in an electric arc furnace is known as skull melting; a solid shell of UC forms between the water-cooled copper crucible and the melt, preventing molten UC from reacting with the metal crucible. This ensures the required purity of the nuclear fuel. To be able to cast the melt, tilting furnaces or centrifugal casting furnaces are used.

### 41.8.3 Nitrides

The nitrides UN, U<sub>2</sub>N<sub>3</sub>, and UN<sub>2</sub> are analogous to the carbides. The mononitride has a theoretical density of 14.32 g/cm<sup>3</sup> [74]. Under N<sub>2</sub> at normal pressure (100 kPa), UN decomposes at 2800 °C in a uranium-rich melt with liberation of N<sub>2</sub>. If the N<sub>2</sub> pressure is reduced to 10 Pa, the decomposition temperature decreases to 2080 °C. Above 2.5 × 10<sup>5</sup> Pa, UN melts without decomposition [75]. At nitrogen pressures above atmospheric and 1300 °C, U<sub>2</sub>N<sub>3</sub> disproportionates into UN + UN<sub>2</sub> with a 13% decrease in volume [76].

The mononitride is produced by three main methods [77]:

#### 1. Reaction of uranium metal with nitrogen

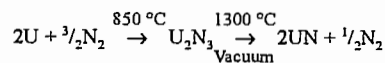

#### 2. Reaction of UH<sub>3</sub> with nitrogen

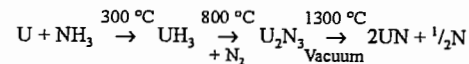
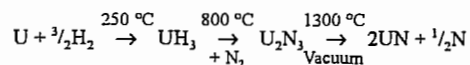

#### 3. Reaction of uranium oxide with carbon and nitrogen

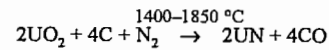

If method 3 is used, the nitride always contains some carbon and oxygen [77].

The nitrides have not yet become important nuclear fuels for power reactors, but the properties of uranium nitrides have recently been investigated again in detail with the aim of using them as nuclear fuels for special reactors (e.g., in space applications) [78–81].

### 41.8.4 Oxides

The following oxides of uranium are known:

- Uranium monoxide, UO, discovered by X rays, of no industrial importance
- Uranium dioxide, UO<sub>2</sub>, an important reactor fuel
- UO<sub>2.3</sub>, stable only above 500 °C, tetragonal crystal structure
- UO<sub>2.33</sub>–U<sub>3</sub>O<sub>7</sub>, tetragonal crystal structure
- U<sub>4</sub>O<sub>9</sub>, formed as an intermediate from UO<sub>2</sub> at high temperature
- U<sub>2</sub>O<sub>5</sub>, monoclinic crystal lattice, red-brown
- U<sub>3</sub>O<sub>8</sub>, stable in all temperature regions (U<sub>2</sub>O<sub>5</sub>·UO<sub>3</sub>), black
- UO<sub>3</sub>, stable up to ca. 300 °C, orange
- Uranium peroxide, UO<sub>4</sub>, light yellow

#### 41.8.4.1 Uranium Dioxide

Production of the industrially important uranium dioxide is described in Section 41.7.4.5. Important physical properties are

Theoretical density	10.96 g/cm <sup>3</sup>
mp	2860 ± 70.5 °C
Thermal conductivity at 500 °C	4.3 W m <sup>-1</sup> K <sup>-1</sup>
at 1100 °C	2.6
at 1650 °C	2.15
at 2200 °C	4.3
Linear coefficient of expansion (4–2800 °C)	1.1 × 10 <sup>-5</sup> K <sup>-1</sup>
Specific heat capacity (32–315 °C)	237.4 J kg <sup>-1</sup> K <sup>-1</sup>

The crystal lattice of UO<sub>2</sub> is face-centered cubic of the CaF<sub>2</sub> type. Stoichiometric UO<sub>2</sub> powder is pyrophoric and is oxidized in air to intermediate products (UO<sub>2.30</sub> and UO<sub>2.33</sub>) or to U<sub>3</sub>O<sub>8</sub>.

UO<sub>2</sub> powder with a large specific surface area is self-igniting. Therefore, handling of UO<sub>2</sub> powders with BET surfaces ≥ 2 mm<sup>2</sup>/g requires special precaution measures, e.g., surface oxidation in a controlled manner.

#### 41.8.4.2 Uranium Trioxide

Normal decomposition at 300 °C of intermediate products obtained during uranium production always leads to orange-colored UO<sub>3</sub>. At > 400 °C, this begins to change into black U<sub>3</sub>O<sub>8</sub>. Uranium trioxide occurs in five forms:

- α-UO<sub>3</sub> is formed by careful decomposition of UO<sub>4</sub> at 450–500 °C [82].
- β-UO<sub>3</sub> is formed by slow decomposition of ammonium diuranate at 450–500 °C [83].
- γ-UO<sub>3</sub> is formed by slow decomposition of uranyl nitrate hexahydrate (e.g., 4 h at 550 °C) [84].
- δ-UO<sub>3</sub> is red and is formed by dehydration of UO<sub>3</sub>·H<sub>2</sub>O in air at 375 °C [83].
- ε-UO<sub>3</sub> is brick red and is formed in a few minutes by oxidation of U<sub>3</sub>O<sub>8</sub> with NO<sub>2</sub> at 350 °C [83].
- ζ-UO<sub>3</sub> is a brown powder produced by rapid decomposition of uranyl nitrate hexahydrate in the presence of 0.6% sulfamic acid [85]. The existence of this compound is not yet certain.

Uranium trioxide can be an intermediate in the production of nuclear fuel, but it is not itself used.

#### 41.8.4.3 Triuranium Octaoxide

The polymorphism of U<sub>3</sub>O<sub>8</sub> is extremely complex, and the data are to some extent conflicting. A summary is given below:

At normal pressure, four modifications exist denoted by α, α', α'', and β. Of these, α and β are base-centered rhombic, α' is body-cen-

tered rhombic, and α'' is hexagonal. The α-forms are stable at low temperature (room temperature) and the β-form at high temperature (> 730 °C). At 50 °C, the α-form changes to the α'-form [86]. The α-form changes to the β-form at high pressure or under shear forces at 1100–1500 °C in the presence of atmospheric oxygen [87]. However, β-U<sub>3</sub>O<sub>8</sub> has a lower density and changes back to α-U<sub>3</sub>O<sub>8</sub> at 50 °C. Therefore, the reported phase transitions depend on temperature, pressure, and redox reactions, which cause changes in density. The interrelationships between the different phases are thus very complex.

Another U<sub>3</sub>O<sub>8</sub> (or UO<sub>2.67</sub>) phase has been described, which is formed only at high pressure at ca. 627 °C and has a face-centered cubic structure. The combination of pressure and shear stress is said to be important for formation of this phase [86]. Thus, cubic U<sub>3</sub>O<sub>8</sub> is obtained from α-U<sub>3</sub>O<sub>8</sub> by prolonged milling in a ball mill, conversion being almost complete after one week. Considerable amounts of water are taken up during milling. Therefore, to obtain a pure product, α-U<sub>3</sub>O<sub>8</sub> is first milled for 72 h; the mixture of α-U<sub>3</sub>O<sub>8</sub> and cubic U<sub>3</sub>O<sub>8</sub> obtained is heated to 750 °C; this is then milled again for 24 h in the absence of moisture. After milling for another 30 h in contact with atmospheric oxygen, an amorphous variety of α-UO<sub>3</sub> is formed.

Of four other possible modifications, the existence of two is fairly well established: γ-U<sub>3</sub>O<sub>8</sub> is said to be formed at 940 °C from β-U<sub>3</sub>O<sub>8</sub> with a heat of transformation of 4.63 ± 0.06 kJ/mol [88]. At 120 °C, this changes back irreversibly to α-U<sub>3</sub>O<sub>8</sub>, the heat of transformation being 4.40 ± 0.21 kJ/mol. The δ-U<sub>3</sub>O<sub>8</sub> modification is formed above 1050 °C [89]. It crystallizes in a rhombic structure with unit cell dimensions a = 0.670 nm, b = 1.246 nm, and c = 0.851 nm. The density is said to be 7.86 g/cm<sup>3</sup>.

Oxygen is evolved when U<sub>3</sub>O<sub>8</sub> melts, so the melting point cannot be determined; U<sub>3</sub>O<sub>8</sub> vaporizes at 925–1525 °C with formation of mainly monomeric gaseous UO<sub>3</sub> [90].

The specific magnetic susceptibility of U<sub>3</sub>O<sub>8</sub> does not obey the Curie law or the Cu-

rie-Weiss law; this indicates that  $U_3O_8$  should be written as  $U_2O_5 \cdot UO_3$ . The electrical conductivity of  $U_3O_{8\pm x}$  depends strongly on temperature and the O:U ratio, so a generally valid value cannot be given. The oxide  $U_3O_8$  is an *n*-type semiconductor. Conduction is thought to occur by electrons and also by holes. Because of its mixed oxide properties, electron transport from U(V) to U(VI) is assumed.

**Chemical Properties.** Triuranium octaoxide dissolves readily in oxidizing acids and is oxidized to the hexavalent state and hydrolyzed to uranyl salts [e.g.,  $UO_2(NO_3)_2$ ] in the aqueous phase. Uranyl chloride,  $UO_2Cl_2$ , is formed by passing HCl gas over  $U_3O_8$  at 700 °C. Triuranium octaoxide is insoluble in water and is oxidized rapidly to  $UO_4$  (uranium peroxide) by hydrogen peroxide; it is reduced by hydrogen or ammonia to  $UO_2$  at > 500 °C.

#### 41.8.4.4 Peroxides

Of the uranium oxides containing a peroxide group, the existence of two is well established:  $UO_4$  (crystallizing with two or four molecules of water) and  $U_2O_7$  with or without water of crystallization.

The hydrate  $UO_4 \cdot xH_2O$  can be precipitated easily from aqueous uranyl nitrate solutions at room temperature by addition of  $H_2O_2$ :

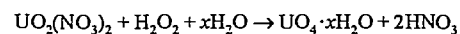

This precipitation easily can be performed continuously, and the precipitate can be dried to give a powder with good flow properties [91].

A  $UO_4$  powder with good sintering properties is prepared from a solution of uranyl nitrate (90–120 g/L) in 0.5 mol/L  $HNO_3$  to which ammonium nitrate (80 g/L) has been added. Precipitation at pH 1.5 and 40 °C occurs at a uranium:hydrogen peroxide ratio of 1:3. The  $UO_4$  powder formed is a spheroidal to spherical agglomerate with a maximum particle size of 50  $\mu m$ , although most particles are

ca. 20  $\mu m$ . Calcination of this powder gives a product with good sintering properties.

The hydrate  $UO_4 \cdot xH_2O$  is pale yellow;  $UO_4 \cdot 4H_2O$  is the main product at a precipitation temperature of < 50 °C,  $UO_4 \cdot 2H_2O$  at higher temperature. Careful dehydration in a vacuum at ca. 130 °C gives hydrated  $U_2O_7$ , which decomposes with liberation of oxygen above 150 °C.

The structure of  $UO_4 \cdot xH_2O$  has not yet been established, but  $U_2O_7$  probably has the following structure [92]:

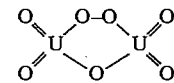

This is a brick-red to orange hygroscopic substance [93].

#### 41.8.5 Nitrates

Uranium and its oxides dissolve in nitric acid to form uranyl nitrate:

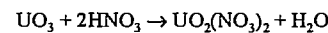

The hexahydrate crystallizes from weakly acidic supersaturated solutions, but tri- and dihydrates can be obtained at higher concentration of  $HNO_3$  (Figure 41.35). Upon evaporation of uranyl nitrate solutions to > 450 g/L uranium,  $UO_2(NO_3)_2 \cdot 6H_2O$  (mp 60 °C) crystallizes on cooling [94]. The uranium content of a solution boiling at 120 °C is ca. 1000 g/L. The trihydrate melts at 113 °C, and the dihydrate at 184 °C. No decomposition occurs up to this temperature, but denitration begins above 300 °C. The  $UO_3$  so produced has a relatively high bulk density (3.5–4.3 g/cm<sup>3</sup>) and, after reduction to  $UO_2$ , is not very suitable for the production of compressed and sintered pellets. The nitrate of U(IV),  $U(NO_3)_4$ , can be obtained by treatment of uranyl nitrate with reducing agents such as hydrazine, iron(II) formate, or  $SO_2$ , or by electrolytic reduction. Uranium(IV) nitrate is a green substance, in marked contrast to yellow  $UO_2(NO_3)_2$ . It oxidizes readily to U(VI) in air.

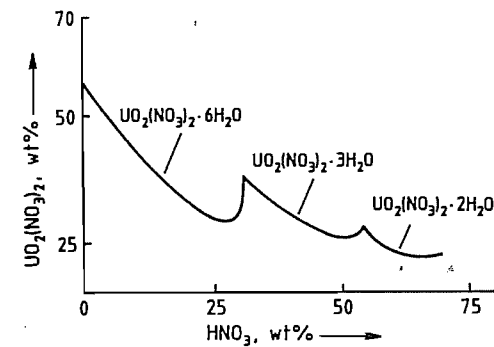

Figure 41.35: The  $UO_2(NO_3)_2$ - $HNO_3$ - $H_2O$  system.

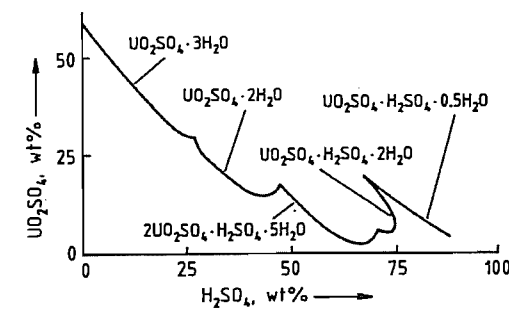

Figure 41.36: The  $UO_2SO_4$ - $H_2SO_4$ - $H_2O$  system.

#### 41.8.6 Sulfates

The sulfates of uranium are important because uranium ores are usually digested with sulfuric acid (see Section 41.7.4.1), which generally leads to the formation of uranyl sulfate,  $UO_2SO_4$ . The nature of the hydrates formed depends on the  $H_2SO_4$  concentration (Figure 41.36). Sulfates of tetravalent uranium are more stable than nitrates. The following hydrates are known:  $U(SO_4)_2 \cdot 8H_2O$ ,  $U(SO_4)_2 \cdot 4H_2O$ ,  $U(SO_4)_2 \cdot 9H_2O$ , and  $U(SO_4)_2 \cdot 2H_2O$ .

#### 41.8.7 Tricarbonatodioxouranate

Tricarbonatodioxouranate,  $[UO_2(CO_3)_3]^{4-}$ , is formed by alkaline digestion and in the AUC process. The ammonium salt of this anion (AUC) decomposes above 80 °C, liberating  $CO_2$  and forming ammonium diuranate.

## 41.9 Safety

The normal safety precautions taken in the chemical industry when handling toxic, liquid, volatile, and gaseous substances must be observed also in the case of uranium, but in addition radiation protection and criticality safety must be included. These affect plant and equipment design and may necessitate the use of apparatus with dimensions not generally employed in chemical technology (see Section 41.9.3), but reflecting all considerations as regards chemical, nuclear, and radiological safety.

### 41.9.1 Radiation Shielding

Handling natural uranium that has not been irradiated does not present special problems. The danger of unacceptable emission of radiation is generally small, nevertheless, all processes are generally emboxed. Special attention must be given to cleaning  $UF_6$  cylinders because buildup of  $^{234}Th$ , which is in equilibrium with  $^{238}U$ , can occur. After evaporation of  $UF_6$ , the cylinder still contains residues in the form of uranium decay products. However, providing shielding against the intense  $\beta$ -radiation and bremsstrahlung emitted by these residues while they are being treated is not difficult.

In addition, the uranium content of atmosphere and contamination of the workplace are measured and controlled to protect personnel from uptake of or contamination by uranium. If legal limits are exceeded, respiratory protection must be provided. Workers must also be examined with a lung monitor at regular intervals, and the uranium content of urine must be determined. If uptake of uranium is suspected, whole-body measurements must be carried out.

Maximum permitted uranium concentrations in air at the workplace and in the form of surface contamination are given in Table 41.12.

**Table 41.12:** Maximum permitted uranium concentrations in the workplace (with figures for other toxic elements for comparison) [95].

	Outside atmosphere, mg/m <sup>3</sup>	In the workplace	
		Inactive area, mg/cm <sup>3</sup>	Active area <sup>a</sup> , mg/cm <sup>3</sup>
Natural uranium	180	150	1500
Uranium with 5% <sup>235</sup> U	42	35	350
Uranium with 10% <sup>235</sup> U	24	20	200
HF	2000		
Pb	200		
Be	2.0		
<sup>239</sup> Pu	0.000032	0.00017	0.0017

<sup>a</sup>Workplace where radioactive materials are processed.

### 41.9.2 Safety Against Uncontrolled Criticality

Criticality safety includes all technical and organizational measures taken to prevent an uncontrolled chain reaction. Uranium with its natural isotopic composition becomes critical only under special reactor conditions. This means that a spontaneous chain reaction under the conditions of uranium processing is impossible. However, in contrast to uranium with a natural isotopic composition, enriched uranium can have a critical configuration under considerably simpler circumstances (e.g., during manufacture or storage of fuel elements). The critical mass depends mainly on the degree of enrichment of <sup>235</sup>U, the composition of the material, and the moderating effect of the geometrical configuration.

In Germany, for example, plants for processing nuclear fuels can, therefore, be operated only if they are licensed under §7 of the Atomic Energy Law, which specifies essential criteria for the nuclear safety of personnel and of the environment. Similar regulations apply in other countries.

In older plants, the observance of limit values was ensured mainly by measures under the control of plant personnel, but in newer plants this has been superseded by automatic control

and is largely independent of human error. Exact and in licensing approved and validated computer codes enable a reduction of extra safety margins, so that larger vessels can be used with the knowledge that they are geometrically safe with respect to permitted criticality dimensions. In addition, more precise calculation of neutron interactions between individual vessels can be carried out with these methods; hence, a space-saving arrangement of components is possible.

### 41.9.3 Geometrically Safe Vessels

The nuclear safety of a critically safe ( $k_{\text{eff}} < 0.95$ ) thickness of material is achieved by increasing the surface of a vessel, thereby increasing the loss of neutrons to the environment and preventing the neutron population necessary to reach a critical condition. The safe geometry is determined as follows:

A hypothetical optimum neutron reflector is assumed to be present at the vessel, whether or not this assumption corresponds to actual conditions. This assumed reflector reduces calculated neutron loss considerably, and, therefore, causes a calculated increase in activity exceeding that of the actual arrangement. The smallest dimensions of the vessel in which a self-sustaining chain reaction can occur are found, based on the combined effects of concentration of fissile material, degree of moderation, and neutron loss by leakage by using this conservative method of calculation. From these conservatively smallest critical dimensions for ideally reflected uranium-water systems, the largest safe subcritical dimensions for  $k_{\text{eff}} = 0.95$  can be deduced, including safety factors (Table 41.13). Safe maximum amounts of uranium under all circumstances are listed in columns 2 and 3 of Table 41.13. The geometric dimensions in columns 4–6 apply to any amounts of uranium, provided  $\rho_U < 3.5 \text{ g/cm}^3$ .

**Table 41.13:** Safe masses and geometries for uranium salts and solutions as a function of degree of enrichment for a total density  $< 3.5 \text{ g/m}^3$ .

Degree of enrichment, % <sup>235</sup> U	Mass of <sup>235</sup> U max., kg	Total mass of U max., kg	Safe volume, L	Safe cylinder diameter, cm	Safe thickness of material, cm
100	0.350	0.35	4.4	12.70	3.81
75	0.360	0.46	5.0	13.21	4.06
50	0.390	0.76	6.0	14.48	4.83
40	0.410	1.025	6.7	5.24	5.08
30	0.440	1.467	7.7	16.00	5.59
20	0.480	2.4	9.5	17.53	6.86
15	0.520	3.467	11.0	18.80	7.87
12	0.583	4.858	12.5	19.81	8.64
10	0.600	6.0	14.0	20.83	9.14
8.0	0.6650	8.125	16.0	22.10	9.91
6.0	0.710	11.833	20.5	24.38	11.43
5.0	0.800	16.0	27.0	26.04	12.70
4.0	0.930	23.25	33.8	28.45	13.97
3.5	1.04	29.714	40.0	30.48	15.24
3.0	1.20	40.0	49.2	32.51	16.51
2.5	1.47	58.8	64.6	35.56	18.03
2.0	2.0	100.0	95.1	40.64	22.10
1.75	2.56	146.286	126	44.70	24.38

### 41.9.4 Apparatus with Heterogeneous Neutron Absorbers

The dimensions of safe vessels are often too small to allow desired throughputs to be achieved. In these cases, considerable benefit can be obtained by incorporating heterogeneous neutron absorbers (nuclear poisons), such as boron carbide or cadmium, into the equipment. Their effect is very dependent on the spatial arrangement of the no-absorption or intermediate vessel walls. For example, fluidized-bed furnaces are provided with a nuclear poison consisting of a central boron carbide rod with double cladding, and rotary  $\text{UO}_2$  mixers with a surface covering or cladding consisting of securely attached cadmium sheets. This ensures nuclear safety even if water penetrates the fluidized bed or rotary mixer (accident safety).

### 41.9.5 Neutron Interactions in the $\text{UO}_2$ Fabrication Plant

A nuclear fuel production plant contains many individual processing stations. Therefore demonstrating that these will remain subcritical as individual units is not sufficient. Equally important is ensuring that no increase

in criticality is caused by interactions of the systems, plant, and equipment due to the way in which they are arranged. The entire layout of processing and storage operations must therefore be in the form of subcritical geometry.

### 41.9.6 Transportation

Plants for ore extraction, processing, and concentration are usually geographically remote from those for fuel assembly production; thus, uranium and its compounds must be transported between these plants. Since the materials being transported are often fissile and radioactive, special precautions must be taken and rules observed. For this reason, the IAEA has issued guidelines that are updated continuously according to the latest knowledge (Regulations for the Safe Transport of Radioactive Materials, IAEA, Vienna), in which national safety regulations are also considered. In its "Safety Series" of publications, the IAEA includes recommendations for methods of transporting radioactive materials, taking international and national regulations into account.

Since shipments often cross international boundaries, international harmonization of

rules and licensing procedures is necessary. This is controlled under the UNO umbrella [96]. The aim of the recommendations, guidelines, and regulations is to protect the general public, transport operatives, and private property from both the direct and the delayed effects of radiation during transportation [96].

This protection is secured by

- Restriction of the nature and activity of the radioactive material, which must be transported only in packaging of a specified type
- Specification of design criteria for each type of packaging
- Rules for handling and storage during transportation

The regulations are intended to prevent the release and uptake of radioactive materials into the human organism, to protect against radiation emitted by the materials being transported, and to ensure that unforeseen criticality events do not occur.

These aims are achieved in practice by

- Containment of the material being transported, the design and sturdiness of the packaging depending on the activity and nature of this material
- Limitation of the maximum dose level at the outer surface of the item being transported, by taking account of the contents of the package and storage techniques used in the transport system
- Protection of the transport container from external effects of an accident, again by taking into account the nature and activity of the material being transported
- Prevention of a criticality event by very restrictive assumptions with respect to the items being transported and the conditions that could arise from an accident

Experience with the transport of radioactive goods has justified the practices used internationally. In industrialized Western countries, no case of injury or death has resulted due to the release of radioactive materials in a transportation accident. This is supported by data from the following countries:

United States: A detailed study of 811 reported incidents between 1971 and 1981

United Kingdom: A study of 330 000 shipments of radioisotopes

Germany: A study of shipments up to 1984 [97]

The positions are underlined when assessing the Mont-Louis incident. In August 1984, the freighter Mont Louis, with a cargo of 350 t  $UF_6$ , sank in 15 m water. Within 40 days, all of the containers were recovered undamaged from the wreck without any release of radioactivity.

## 41.10 References

1. Gmelin, Uranium, Part A: The Element, Part B: The Alloys, Part C: The Compounds, Part D: The Chemistry in Solution, Part E: The Coordination Compounds.
2. Uranium Ore Processing Panel Proceedings Series, printed by IAEA (Internat. Atomic Energy Agency) Vienna, Dec. 1976.
3. S. Villani: Uranium Enrichment, *Topics in Applied Physics*, vol. 35, Springer Verlag, Berlin-Heidelberg-New York 1979.
4. *The Chemical Thermodynamics of Actinide Elements and Compounds*, part I, 1976; part II, 1976; part III, 1978, IAEA, Vienna.
5. Advances in Uranium Refining and Conversion, IAEA-TECDOC-420, Vienna 1987.
6. J. H. Cavendish in W. W. Schulz, J. D. Navratil, T. Bess (eds): *Science and Technology of Tributyl Phosphate*, vol. 2: "Selected Technical and Industrial Uses", CRC Press, Boca Raton, FL, 1987.
7. W. D. Müller: *Geschichte der Kerntechnik in der Bundesrepublik Deutschland*, Schäffer Verlag für Wirtschaft und Steuern, Stuttgart 1990.
8. Int. Symposium on the Oklo-Phänomen, Libreville, Gabon, June 23-27, 1975; IAEA Proc. Series—STI/PUB/405.
9. C. Keller: "Das Oklo Phänomen", *GIT Fachz. Lab.* 30 (1986) no. 5, 423-433; no. 6, 581-585.
10. P. C. Sahu, M. Yousuf, K. Govinda Rajan, *Physica B + C* 183B (1993) 145-155.
11. J. F. Cannon, *J. Phys. Chem. Ref. Data* 3 (1974) 801.
12. ES Microware, TAPP, Thermochemical and Physical Properties, Hamilton, OH, 1991.
13. J. D. Grogan, *J. Inst. Met.* 77 (1950) 571.
14. B. Blumenthal, *J. Nucl. Mater.* 2 (1960) 23.
15. A. N. Holden, US-Report KAPL-480 (1950).
16. R. W. Logan, *Metall. Trans. A* 14A (1983) 2337.
17. L. T. Lloyd, C. S. Barrett, *J. Nucl. Mater.* 18 (1966) 55.
18. M. A. Filyand, E. I. Seminova: *Handbook of the Rare Elements III*, Boston Technical Publ., Cambridge, MA, 1970 (translated by M. E. Alferieff).
19. A. F. Hollemann, E. Wiberg: *Lehrbuch der Anorganischen Chemie*, Walter de Gruyter Verlag, Berlin 1976.
20. J. P. Coughlin, Bulletin 542 U.S. Bureau of Mines, "Contribution to the Data on Theoretical Metallurgy

- X, Heats and Free Energies of Formation of Inorganic Oxides", Washinton, DC, 1954.
21. E. Kohl: *Uran*, Enke Verlag, Stuttgart 1954.
- M. Rauboult: *Géologie de l'uranium*, Paris 1958.
22. Gmelin, A1, 75-77.
23. M. Benedict: *Nuclear Chemical Engineering*, McGraw-Hill, New York 1957.
24. OECD and IAEA: *Uranium, Resources, Production and Demand*, 1991.
25. OECD/NEA, *Uranium 1995 — Resources, Production and Demand*, Paris 1996.
26. *The Uranium Institute Market Report*, Uranium Institute Report 1996.
27. A. Max, T. Mason, *Vergangenheit und Zukunft der U-Produktion* 41 (1996) no. 2, February, p. 79.
28. *Uranversorgung der Welt* 41 (1996) no. 7, Juli, p. 479.
29. K. Schreiber, *Stand und Perspektiven der Uranversorgung. Vortrag Jahrestagung Kerntechnik*, 23.5.1996, Mannheim.
30. H. Kirchberg: *Aufbereitung bergbaulicher Rohstoffe*, Gronau, Jena 1953.
31. E. J. Pryor: *Mineral Processing*, 3rd ed., Elsevier, Amsterdam-London-New York 1965.
32. M. E. Grimes, *Trans. Am. Inst. Min. Metall. Pet. Eng.* 254 (1973) 312-318.
33. I. Higgins, *Environ. Sci. Technol.* 7 (1973) 1100-1140.
34. P. Pfüller, F. J. Gogke, *Aufbereit. Tech.* 14 (1973) 555-560.
35. G. Ritcey: "Extractive Metallurgy of Uranium", *Short Course Toronto Solvent Extraction 1978* 23-31.
36. P. Niederer, *Verfahrenstechnik (Mainz)* 4 (1970) np. 12, 548-554.
37. J. Wyllie, *World Min.* 32 (1979) 58.
38. J. B. Rosenbaum: *Uranium Ore Processing*, IAEA Meeting, Nov. 24-26, 1975 Paper IAEA-AG/33-8, p. 6, Vienna 1976.
39. J. K. Dawson, E. Wait, K. Alock, D. R. Chilton, *J. Chem. Soc.* 1956, 3531-3540.
- W. Biltz, H. Müller, *Z. Anorg. Allg. Chem.* 163 (1927) 257-296.
40. General Electric Co., US 3579311, 1968.
- C. D. Harrington, A. E. Rühle, *Chem. Eng. Prog.* 54 (1958) no. 3, 65-70.
- C. H. Chilton, *Chem. Eng. (N.Y.)* 65 (1958) no. 21, 138-141.
41. P. S. Gentils, L. H. Talley, T. J. Coloppy, *J. Inorg. Nucl. Chem.* 10 (1959) 110-113.
42. G. Wirths, L. Ziel, *Proc. U.N. Int. Conf. Peaceful Uses At. Energy 2nd*, 4 (1958) 16-21.
43. Nukem, DE 1126363, 1960/62; DE 1592477, 1966; DE 1592478, 1967.
- F. Plöger, H. Vietzke, *Chem. Ing. Tech.* 37 (1965) 692-699.
- K. G. Hackstein, F. Plöger, *ATW Atomwirtsch. Atomtech.* 12 (1967) 524-526.
44. T. J. Heal, J. E. Littlehild, H. Page, *Nucl. Eng. Int.* 25 (1980) 48-51.
45. A. Ducouret, B. Kalthoff, *Ber. Jahrestag. Kerntech. Kerntech. Ges. Dtsch. Atomforum* 1980, 405-408.
46. W. C. Ruch, D. A. Peterson, E. A. Gaskil, H. G. Tepp, *Chem. Eng. Prog. Symp. Ser.* 56 (1960) no. 28, 35-41.
47. F. K. Pickert, H. J. Zech: *Brennstoffkreislauf*, Deutsches Atomforum, Bonn 1981.
48. Urenco-Werkzeitschrift, Panorama, Gronau-Almelo-Capenhurst, Dec. 1980.
49. H. Mohrhauer, E. Coester, *Atomkernenerg. Kerntech.* 35 (1980) no. 3, 161-165.
50. W. Becker, K. Bier, *Chem. Ing. Tech.* 39 (1967) no. 1, 1-7.
51. P. Bley, W. Ehrfeld, U. Heiden, KFK report no. 2580, Kernforschungszentrum, Karlsruhe 1978.
52. K. Takeda, H. Onitsuka, H. Obanawa in M. Abe, T. Kataoka (eds.): *New Developments in Ion Exchange*, Kodensha Ltd., Tokyo 1991, pp. 583-589.
53. J. M. Lerat, C. Lorrain, *Conference on Solvent Extraction and Ion Exchange in the Nuclear Fuel Cycle*, Harwell, UK Sep. 3-6, 1985, pp. 53-61.
54. I. D. Heriot: *Uranium Enrichment by Gas Centrifuge*, Commission of the European Communities 1988.
55. H. Kühn, M. Peehs, K. Reichardt: "Thermische Bruterstudie", part 2, *Forschungsber. BMWF Inv. Reaktor 37*, April 1969.
56. M. Peehs et al., *IAEA Tech. Committee on Utilization of Th-based Nuclear Fuel*, Vienna, Dec. 1985.
57. M. Peehs, W. Dörr, M. Hrovat, *IAEA Advisory Group Meeting on Advanced Fuel Technology and Performance*, EIR Würenlingen, Dec. 1984.
58. S. H. Smiley, D. C. Brater, US-Report K-1379 1/18 (1958).
59. J. A. Rode, US 594201, 1966.
60. U. Berndt, B. Erdmann, *Radiochim. Acta* 19 (1973) 45-46.
61. R. J. Sheil, US-Report ORNL-2061-Pt. 1-2-3 Del. 71 (1959).
62. S. Langar, F. E. Blankenship, *J. Inorg. Nucl. Chem.* 14 (1960) 26-31.
63. J. K. Dawson, R. W. M. D'Eye, E. A. Truswell, *J. Chem. Soc.* 1954, 3922-3929.
64. R. DeWitt, US-Report GAT-280, p. 102 (1960).
- G. D. Oliver, H. T. Milton, J. W. Grisard, *J. Am. Chem. Soc.* 75 (1953) 2827-2829.
65. M. W. Mallett, A. F. Gerds, H. R. Nelson, *J. Electrochem. Soc.* 99 (1952) 197-204.
66. W. B. Wilson, *J. Am. Ceram. Soc.* 43 (1960) 77.
67. J. M. Leitnacker, W. G. Wittemann, *J. Chem. Phys.* 36 (1962) 1445.
68. S. Imoto et al., *Proc. of the Symposium at Harwell 1963*, vol. 1, McMillan, Basingstoke 1963, pp. 7-20.
69. J. Dubuisson et al., *Proc. U.N. Int. Conf. Peaceful Uses At. Energy 2nd* 6 (1958) 551.
70. E. Barnes, *Prog. Nucl. Energy Ser. I* 1 (1956) 61.
71. J. K. Dawson, R. G. Sowden: *Chemical Aspects of Nuclear Reactors*, vol. 1, Butterworths, London 1963.
72. H. S. Kalish, US-Report TID-7614 (1961) 99-110.
73. P. Himmelstein, H. Kühn, O. Pfahls, R. Lucas: "Verbesserung der Technologie bei der Fabrikation gegossener Urancarbidge", *Euratom-Report EUR-4273d*.
74. P. D. Shalek, *J. Am. Ceram. Soc.* 46 (1963) 155.
75. R. M. Dell, M. Albutt, UKEA-Report AERE-R 4253 (1963).
76. R. E. Rundle, N. C. Baenziger, A. S. Wilson, R. A. McDonald: "The Structure of Carbides, Nitrides and

- Oxides of Uranium", *J. Am. Chem. Soc.* **70** (1948) 99–105.
77. M. Smith, R. I. Honeycombe, *J. Inst. Met.* **83** (1954/1955) 421–426.
78. T. Matsui, R. W. Ohse, Commission of the European Communities, report EUR-10858, Order no. PB88-125356, 1986.
79. R. B. Matthews, *Space Nucl. Power Syst.* **8** (1989) 201–205.
80. S. L. Hayes, J. K. Thomas, K. L. Peddicord, *J. Nucl. Mater.* **171** (1990) nos. 2/3, 271–288.
81. G. Ledergerber, Z. Kopajtic, F. Ingold, R. W. Stratton, *J. Nucl. Mater.* **188** (1992) 28–35.
82. V. J. Wheeler, R. M. Dell, E. Wait, *J. Inorg. Nucl. Chem.* **26** (1964) 1829–1845.
83. H. R. Hoestra, S. Siegel, *J. Inorg. Nucl. Chem.* **18** (1961) 154–165.
84. V. G. Vlasov, Y. N. Semavin, *Zh. Prikl. Khim. (Leningrad)* **40** (1967) 1210–1215.
85. V. J. Wheeler, R. M. Dell, E. Wait, *J. Inorg. Nucl. Chem.* **26** (1964) 1829–1845.
86. A. N. Tsvigunov, L. M. Kuzvetsov, *Radiokhimiya* **16** (1974) 882–885.
87. H. R. Hoekstra, S. Siegel, L. H. Fuchs, J. J. Katz, *J. Phys. Chem.* **59** (1955) 136–138.
88. G. K. Khomyakov, V. I. Spitsyn, S. A. Zhvanko, *Issled. Obl. Khim. Urana* **1961**, 141–144.
89. A. F. Bessonov, *Kristallografiya* **15** (1970) 62–67.
90. H. Powers, E. Welch, J. B. Trice, NEPA-934-SCR-34 (1949 and 1961).
91. Nukem, DE 2623977, 1976 (P. Börner, H. Vietzke).
92. M. El-Chehabi, Dissertation University of Texas, 1957.
93. J. E. Boggs, M. El-Chehabi, *J. Am. Chem. Soc.* **79** (1957) 4258–4260.
94. W. L. Marshall, J. S. Gull, C. H. Secoy, *J. Am. Chem. Soc.* **73** (1951) 1867.
95. A. Pilgenröther, W. Thomas, *ATW Atomwirtsch. Atomtech.* **16** (1971) 74–77.
96. Bundesminister für Verkehr (eds.), bulletin "Die Beförderung radioaktiver Stoffe", Oct. 19, 1984.
97. Deutscher Bundestag, Drucksache no. 10/2160 Oct. 19, 1984.

## 42 Thorium

WOLFGANG STOLL

42.1 Introduction .....	1649	42.7 Metalworking .....	1673
42.2 Properties .....	1650	42.8 Intermetallic Compounds .....	1675
42.2.1 Physical Properties .....	1650	42.8.1 Thorium and Carbon .....	1675
42.2.2 Chemical Properties .....	1653	42.8.2 Thorium and Nitrogen .....	1675
42.3 Occurrence and Raw Materials .....	1654	42.9 Uses .....	1675
42.4 Production .....	1656	42.9.1 Nuclear Technology .....	1675
42.4.1 Concentration .....	1656	42.9.2 Conventional Applications .....	1678
42.4.1.1 Ore Preparation .....	1656	42.9.2.1 Illuminants .....	1678
42.4.1.2 Ore Digestion and Thorium Recovery .....	1656	42.9.2.2 Electron Emitters .....	1678
42.4.2 Fine Purification by Solvent Extraction .....	1661	42.9.2.3 Ceramics and Glass .....	1678
42.5 Compounds .....	1663	42.9.2.4 Catalysts .....	1679
42.5.1 Oxides .....	1663	42.9.2.5 Medicine .....	1679
42.5.2 Halides .....	1665	42.9.2.6 The Demand for Thorium .....	1679
42.5.2.1 Tetrafluoride .....	1665	42.10 Product Quality and Analytical Methods .....	1679
42.5.2.2 Tetrachloride .....	1667	42.11 Toxicology .....	1681
42.5.2.3 Tetraiodide .....	1667	42.12 Industrial Safety .....	1681
42.5.3 Other Compounds .....	1668	42.13 Environmental Protection .....	1682
42.6 Production of Pure Thorium Metal .....	1669	42.14 Legal Aspects .....	1683
		42.15 References .....	1683

### 42.1 Introduction

Thorium was originally placed in group 4 of the periodic table under titanium, zirconium, and hafnium, following  $_{89}\text{Ac}$ . However, the 5f electron shell is filled in the series of elements from  $_{90}\text{Th}$  to  $_{103}\text{Lr}$ . In analogy to the lanthanides, in which the 4f shell is filled, these elements are therefore referred to as the actinides, thorium being the first in the series [1, 2]. Its similarity to cerium and its mineralogical occurrence in association with the rare earths and uranium confirm this placing. The number of thorium isotopes known thus far, all radioactive, is 25 [3]. The most common of these has the relative atomic mass 232, and five others occur naturally in the decay chains of uranium and thorium. First isolated by BERZELIUS in 1828 from the silicate mineral thorite, thorium attained industrial importance in the late 1800s as a component of gas mantles. By World War II, total consumption world-

wide had amounted to ca. 8000 t, mainly for the production of gas mantles, reaching 250 t in some years. Thorium occurs in only a few regions of the earth's crust in minable amounts, although its average abundance is three to four times that of uranium [4]. After absorbing a neutron, thorium is transformed in several steps into fissile (i.e., fissionable by thermal neutron)  $^{233}\text{U}$ . Thorium thus represents quantitatively by far the greatest energy reserve based on nuclear fission. Therefore, in the early years of nuclear technology, up to 900 t/a thorium was extracted and stockpiled as a strategically important raw material, and some hundreds of tonnes were irradiated in reactors although less than 3 t of  $^{233}\text{U}$  was obtained from this.

However, for partly technical and partly economic reasons this route to energy production is now of little importance except in India. Therefore, since thorium is little utilized in the

nonnuclear field, consumption since 1990 has declined to a few tens of tonnes per year.

## 42.2 Properties

### 42.2.1 Physical Properties

**Formation and Decay.** The most abundant thorium isotope (exceeding the abundance of the other isotopes by a factor of several millions) is  $^{232}\text{Th}$ . Its concentration in the earth's crust obeys Harkins' rule, which states that even-numbered isotopes are more abundant than odd-numbered ones [5]. However, its concentration overall is more than twice that expected from the decrease in abundance of nuclides with increasing atomic number. The half-life of  $^{232}\text{Th}$  (a decay) is  $1.4 \times 10^{10}$  a, the longest of all actinides, and a calculation based on the half-lives of higher actinides shows that this concentration excess must be a result of the decay of primordial actinides such as plutonium and curium in the initial phases of the earth's history. Mineralogical evidence is provided by the fact that the very old thorium mineral bastnaesite, a thorium fluorocarbonate, is so far the only mineral in which traces of the longest-lived transuranic, the isotope  $^{244}\text{Pu}$  with a half-life of  $8.26 \times 10^7$  a, have been detected [6].

As early as 1922, the isotopic ratio  $^{208}\text{Pb}$ : $^{206}\text{Pb}$  and the age-proportional Th:U ratio in old ores were thought to indicate that a parent nuclide to thorium must have existed, whose half-life was estimated to be  $(5.9\text{--}6.3) \times 10^7$  a [7]. This closely matches that of  $^{244}\text{Pu}$ .

Alpha decay of  $^{232}\text{Th}$  leads to  $^{228}\text{Th}$ , while in the uranium decay chain,  $^{238}\text{U}$  gives the short-lived  $^{234}\text{Th}$  and  $^{230}\text{Th}$ , and decay of  $^{235}\text{U}$  gives  $^{231}\text{Th}$  and  $^{227}\text{Th}$ . Because of the low concentration of  $^{235}\text{U}$  (0.711%) in natural uranium and the short half-lives of the last two thorium isotopes, these are of little quantitative significance.

The thorium decay chain from  $^{232}\text{Th}$  to  $^{208}\text{Pb}$  is shown in Figure 42.1 [8].

The concentration ratio of  $^{232}\text{Th}$  to  $^{228}\text{Th}$  at equilibrium corresponds to the ratio of their

half-lives. In  $^{232}\text{Th}$  irradiated in a reactor, an even higher proportion of  $^{228}\text{Th}$  and of the follow-on daughter nuclides from  $^{232}\text{U}$  decay chain is present, which is indicated, e.g., by the intensified 2.6-MeV  $\gamma$ -radiation from  $^{208}\text{Tl}$ .

Neutron absorption leads to the formation of  $^{233}\text{Th}$  from  $^{232}\text{Th}$ . By two subsequent  $\beta$  decays  $^{233}\text{U}$  is formed which decays to form the long-lived  $^{233}\text{Th}$  (half-life 7340 a). The other thorium isotopes with mass numbers 212–225 are very short-lived  $\alpha$ -emitters formed by decay of the corresponding uranium isotopes, and the isotopes  $^{235}\text{Th}$  and  $^{236}\text{Th}$  are short-lived  $\beta$ -emitters; all are produced by artificial transmutation and are of no industrial importance.

Like all other actinides,  $^{232}\text{Th}$  also undergoes spontaneous fission with neutron emission, although, being the first member of the series, it has the longest half-life (i.e.,  $> 10^{21}$  a). The xenon isotopes expected as fission products can be found in old thorium ores, which also contain 1–10 cm<sup>3</sup> of helium per gram from  $\alpha$ -decay. The helium can be boiled out with water.

Where tetravalent uranium is present in primary ores, it is usually associated with thorium, whose principal valence is also 4. Therefore, the thorium isotopes present come from all three decay chains ( $^{235}\text{U}$ ,  $^{238}\text{U}$ ,  $^{232}\text{Th}$ ). The isotope  $^{230}\text{Th}$  (ionium), a decay product of  $^{234}\text{U}$ , is important because of its relatively long half-life (75 400 a) and, at equilibrium, is present at a level of  $1.76 \times 10^{-3}\%$  of the proportion of uranium in the thorium.

The activity of freshly separated  $^{232}\text{Th}$  passes through two activity maxima due to the formation of decay products. The first of these, which gives approximately a threefold increase in activity, is due to the six short-lived decay products of  $^{228}\text{Th}$  (half-life 1.9 a) and occurs after ca. 5 weeks. The second increase begins after ca. 4 a when  $^{228}\text{Th}$  is formed from  $^{228}\text{Ra}$  (half-life 5.75 a), and the original radiation level increases almost five-fold after 40 a (Figure 42.2).

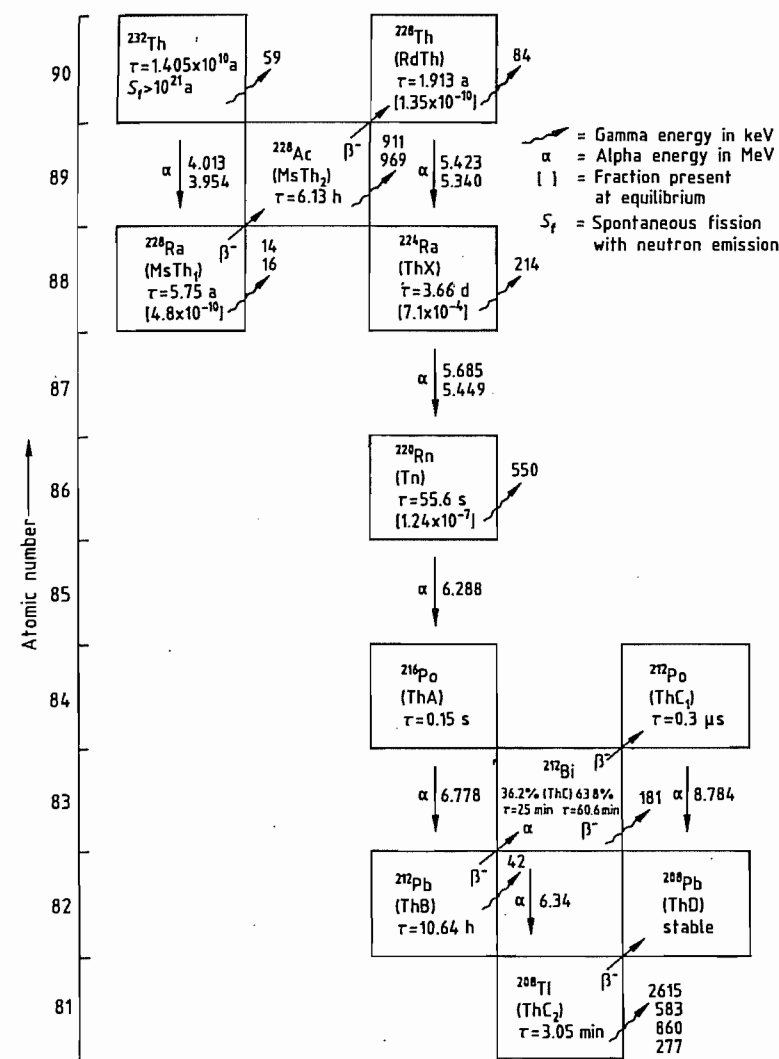

Figure 42.1: Thorium decay chain.

Pure thorium is a silvery-white, ductile metal, with low strength properties and chemical resistance [9]. It becomes gray on exposure to air. Finely divided thorium is pyrophoric. These disadvantages can be mitigated slightly by adding alloying elements. Solid thorium has the highest atomic density of all thorium compounds, which favors its use in nuclear reactors.

The physical properties and thermodynamic data of thorium are listed below. Tho-

rium exists in two solid phases, the  $\alpha$ -phase (lattice constant 0.5068 nm) is stable at room temperature and is transformed to the  $\beta$ -phase (lattice constant 0.411 nm) at  $1360 \pm 10$  °C (heat of transformation  $3600 \pm 125$  J/mol). The phase transformation  $\beta$ -phase-liquid occurs at 1750 °C. Thorium has a  $b_p$  of 4702 °C. The molar heat capacities are as follows:

$\alpha$ -phase  $a$ : 25.5 J/mol  
 $b \times 10^3$ : 4.48 J/mol  
 $c \times 10^{-5}$ : -0.51 J/mol



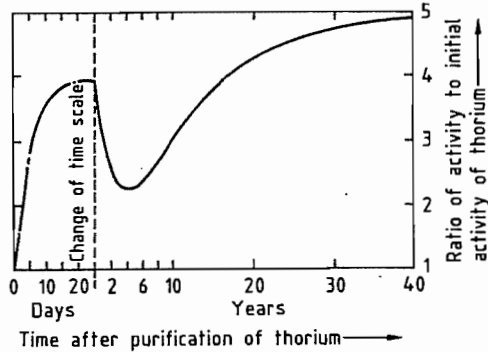

Figure 42.2: Change in reactivity with time of natural  $^{230}\text{Th}$  plus  $^{228}\text{Th}$  after separation from their daughters at time zero.

where  $a$  denotes the linear,  $b$  the quadratic, and  $c$  the cubic term in the equation for the heat of transformation ( $Q = at + bt^2 + ct^3$ )

$\beta$ -phase  $a$ : 15.70 J/mol

$b$ : 11.97 J/mol

liquid 46.06 J/mol

The vapor pressure  $p$  (atm) is given by

$$\log p = a - \frac{b}{T}$$

where  $T$  is the temperature in kelvin, and  $a$  and  $b$  are 27.84 and 129.67 J/mol for the  $\alpha$ -phase and 25.10 and 124.02 J/mol for the liquid.

Thorium crystals have a density of 11.72 g/cm<sup>3</sup> at 25 °C; the apparent density of the cast metal is only 11.5–11.6 g/cm<sup>3</sup>.

Mechanical, thermal, and electrical properties of thorium metal are very sensitive to the level of impurities, especially the carbon content. The level of impurities typically varies according to the method of production. The purest and hence most ductile metal, prepared from the iodide by the van Arkel process (see Section 42.6), is used only in exceptional cases.

The effect of the thorium production process on strength properties is shown in Table 42.1.

The dependence of Brinell hardness (N/mm<sup>2</sup>) on the metal treatment process is given below:

Annealing or sintering	400–600
Moderate deformation (50–80%)	600–800
Strong deformation (10 × elongation)	1100–1500

Table 42.1: Effect of production process on strength properties.

Production process	Ultimate tensile strength, MPa	Tensile strength (0.2% offset), MPa	Elongation, %
From iodide	125	42	40
By Ca reduction	175	105	60
Compressed and sintered thorium	245	175	35

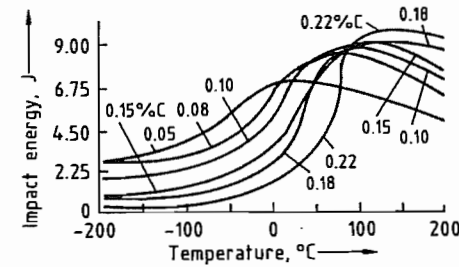

Figure 42.3: Effect of carbon content of thorium on impact energy [10].

Table 42.2: Linear thermal coefficient of expansion ( $\alpha$ ) of thorium.

Temperature range, K	$\alpha \times 10^6, \text{K}^{-1}$	
	Westinghouse Th	Ames Th
298–473	11.2	10.8
473–948	12.3	11.8
948–1273	13.8	13.4
298–1273 <sup>a</sup>	12.6	12.4

<sup>a</sup>Mean value.

Figure 42.3 shows the temperature dependence of the mechanical impact strength as a function of carbon content. The linear coefficient of expansion of Westinghouse and Ames thorium is listed in Table 42.2. As in the case of carbon-containing steels, marked cold embrittlement occurs with carbon-containing thorium over a certain range of carbon content, whereas with pure thorium, embrittlement increases continuously with decreasing temperature.

The variation of thermal conductivity ( $\text{Wcm}^{-1}\text{K}^{-1}$ ) with temperature is given below [11]

100 °C	0.377
200 °C	0.389
300 °C	0.402
400 °C	0.419
500 °C	0.427
600 °C	0.444
650 °C	0.452

This property is affected only slightly by the content of impurities, whereas the electrical conductivity is much reduced by impurities. At room temperature, pure thorium has an electrical resistance of  $14 \pm 1 \times 10^{-6} \Omega/\text{cm}$ . With 0.03% C, the figure is  $18 \times 10^{-6} \Omega/\text{cm}$ , and with 0.2% C,  $37 \times 10^{-6} \Omega/\text{cm}$ —the temperature coefficient of resistivity being  $(3.6\text{--}4) \times 10^{-3} \text{K}^{-1}$ .

Thorium metal is superconducting below 1.368 K.

Thorium has a very low work function of thermal electrons [9] (Figure 42.4). The emission of electrons from “thoriated” tungsten wires is up to four orders of magnitude higher than that from pure tungsten in the lower temperature region. (For further details, see Section 42.9.2.)

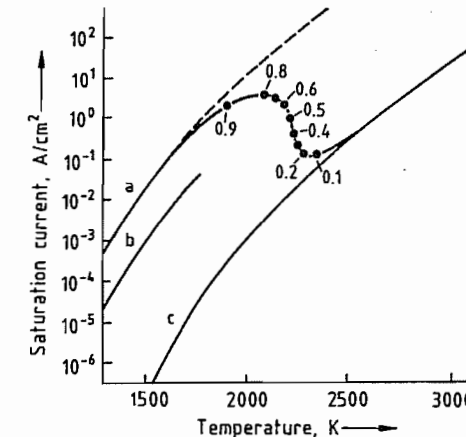

Figure 42.4: Effect on temperature on state of activation: a) Thoriated tungsten (monoatomic layer); b) Thorium; c) Pure tungsten.

This low work function is in fact more likely to be a property of the oxidized surface of thorium, possibly formed by a suboxide such as “ThO”, rather than of the pure metal. This is suggested by the fact that in  $\text{Th}^{2+}$  the electronic transition from  $5f$  to  $6d$  is facilitated by the extremely small difference in bonding energies (i.e., only  $570 \text{ cm}^{-1}$ ), which is better than an order of magnitude less than the  $5f$ – $6d$  transition in neighboring elements and is a result of the interaction of a valence electron with the empty  $5f$  shell, which can occur only with thorium (Figure 42.5) [1, p. 144].

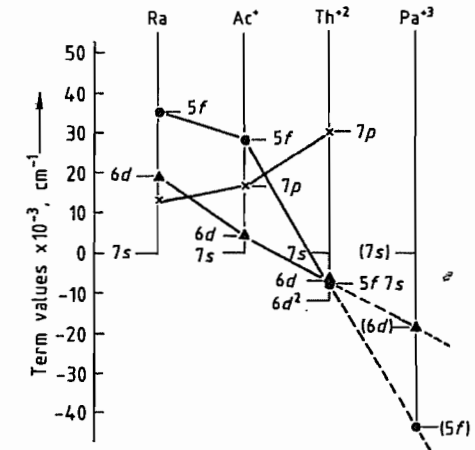
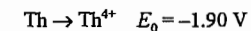

Figure 42.5: Relative binding energies in the radium iso-electronic sequence.

The standard electrode potential of thorium is



It is therefore somewhat more negative than zirconium or aluminum. The overvoltage of  $\text{H}_2$  on thorium is  $0.38 \pm 0.01 \text{ V}$ . Thorium cannot be deposited electrolytically from aqueous solutions, and its deposition at a mercury electrode is also doubtful. Oxide-aquates are formed instead. The production of thorium metal by fused salt electrolysis is described in Section 42.6.

## 42.2.2 Chemical Properties

Thorium is nearly always tetravalent but, exceptionally, can have a valence of two (thorium hydride) or three.

In moist air, thorium metal oxidizes slowly at its surface even at room temperature. Oxidation proceeds in two stages. First, a surface layer of the dark gray hydride is formed by reaction with atmospheric moisture, the hydride is then oxidized, with formation of a strongly bonded oxide layer. Above 130 °C the rate of oxidation increases together with ablation of the oxide film, and at 450 °C, rapid oxidation begins with the evolution of heat. Thorium burns like magnesium, with an intense flame—pulverized thorium ignites spontaneously. Above 670 °C, thorium reacts with ni-

trogen to form  $\text{Th}_2\text{N}_3$ . Thorium reacts with hydrogen at 300–400 °C, with the evolution of heat, to form  $\text{Th}_4\text{H}_{15}$ , which itself decomposes above 1100 °C, probably forming  $\text{ThH}_2$ , a gray-black powder that ignites spontaneously and is isomorphous with  $\text{ZrH}_2$ . Thorium can therefore be melted only in an inert-gas atmosphere or in a vacuum.

Thorium reacts violently with the halogens and with sulfur on heating to 450 °C, producing a flame, and it reacts with fluorine even in the cold. The oxidation state of thorium is 4 in all the compounds formed. Thorium is hardly attacked at all by water, even when hot, but reacts at 800–900 °C with water vapor to form  $\text{ThO}_2$ .

On heating with phosphorus, finely divided boron, or carbon, tetravalent compounds are formed immediately, as in the reaction with nitrogen. Alloys are formed with all actinides and lanthanides, iron- and platinum-group metals, alkali metals (except Li), Mo, W, Ta, Zn, Zr, Hf, Be, Al, and Si.

Thorium is stable toward dissolved or molten alkali and is attacked only slowly by dilute mineral acids. It is passivated in  $\text{HNO}_3$ , but the effect disappears in the presence of small concentrations of HF or  $\text{H}_2\text{SiF}_6$  (0.05 mol/L), and thorium is then dissolved rapidly. Thorium dissolves in aqua regia and concentrated HCl. Thorium salts generally contain tetravalent thorium. They have only a slight tendency to hydrolyze. A pH of 3.7 is required to remove the first hydrogen ion from the water molecule according to

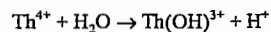

The thorium ion forms anionic complexes with a large number of ions in acidic or neutral solution (e.g.,  $\text{CO}_3^{2-}$ ,  $\text{C}_2\text{O}_4^{2-}$ ,  $\text{SO}_4^{2-}$ ,  $\text{HSO}_4^-$ ,  $\text{PO}_4^{3-}$ , citrate, and tartrate). Thorium forms positively charged complexes with  $\text{F}^-$  if the molar ratio of  $\text{F}^-$  to  $\text{Th}^{4+}$  is  $< 2$ . Complexes are also formed with an excess of thiocyanide and nitrate. Thorium has a strong tendency to form double salts such as  $\text{K}_2\text{ThF}_6 \cdot 4\text{H}_2\text{O}$ ,  $\text{NaTh}_2(\text{PO}_4)_3$ ,  $\text{MnTh}(\text{SO}_4)_3 \cdot 7\text{H}_2\text{O}$ , and  $\text{ThSO}_4\text{HPO}_4 \cdot 4\text{H}_2\text{O}$ ; it also forms basic salts such as  $\text{ThOCO}_3 \cdot 2\text{H}_2\text{O}$ . The strong adsorptive

forces of the  $\text{Th}^{4+}$  ion, which are exemplified by the formation of stable colloidal solutions in salt solutions with full gel-sol reversibility, especially in the system  $\text{Th}^{4+}\text{-NO}_3\text{-OH}^-$ , is used in industrial production of  $\text{ThO}_2$ -particles of high density.

Some of the salts have very low solubility in acids (e.g., the iodates, peroxides, oxalates, fluorides, phosphates, complex sulfophosphates, ferrocyanides, and the double salt potassium thorium sulfate); these are used industrially to separate thorium. For more recent separation processes, the fact that thorium nitrate forms complexes with tributyl phosphate (TBP) and other organophosphates that are soluble in organic solvents is of great importance. These are useful for separating thorium from the rare earths (RE).

Although the readiness of the valence electrons to occupy the empty inner 5f shell is too small for any oxidation states other than 4 to be stable, it is deemed to be sufficient for covalent bonding. This gives thorium also a remarkable catalytic activity.

### 42.3 Occurrence and Raw Materials

Primary thorium deposits occur in acidic granitic magmas and pegmatites. They are locally concentrated, but of a small size. Secondary deposits are found in placer deposits at the mouths of rivers in granitic mountain regions (e.g., in India, Indonesia, and Brazil). In these deposits, thorium is enriched along with other heavy minerals.

Thorium, together with the related rare earths, is believed to have remained in the silicate layers during the phase separation of the earth because of their affinity for oxygen. Wherever these elements have not become bonded in the apatites formed in the initial crystallization, thorium became concentrated in the acidic residual magmas, especially in the nepheline syenite pegmatites, where it can be found at concentrations of ca. 80 mg/kg (Hungary) compared with the average level in granites (5–15 mg/kg Th). If these minerals

have been formed at high temperature, uranium is also present because of the isomorphism of  $\text{UO}_2$  and  $\text{ThO}_2$ , although at lower temperature in the presence of oxygen and water, uranium can migrate away as a hexavalent ion.

Since thorium minerals are attacked only slightly by reactive components of the atmosphere (e.g., oxygen, nitrogen) and by aqueous solutions, they have been deposited in a sedimentary sequence (monazite has a density of 4.3–5.6) along with other heavy minerals such as magnetite, rutile, cassiterite, garnet, ilmenite, and zircon in placer deposits, which sometimes also contain gold. If any thorium was present in the rivers in solution, it was precipitated together with dissolved iron as carbonate and fluoride on entering the sea.

Because of its low water solubility, thorium is scarcely present in water, soil, plants, or ani-

mals, even if the sand under a biotope contains thorium.

More than 100 different ores contain thorium minerals. The most important are listed in Table 42.3. No deposits exist that are worth extracting for thorium alone, so it is almost always extracted as a coupled product with the rare earths, which themselves can be a side product of the production of other heavy minerals when they are in the form of monazite from a gravity concentration process.

The most widely occurring and important mineral is monazite, a phosphate of rare earths and thorium, in which the content of individual metals varies with the origin of the mineral (Section 44.3). Typical compositions of monazite concentrates from five important deposits are given in Table 42.4 [12].

Table 42.3: Thorium minerals containing > 3% Th (mean value).

Name	Formula	Th content, %	Principal deposits
<b>Oxides</b>			
Thorianite	$\text{ThO}_2$	45.3–87.9	Sri Lanka
Uranothorianite	$(\text{U}, \text{Th})\text{O}_2$	15–48	Canada, Madagascar
<b>Phosphates/silicates, carbonates</b>			
Thorite	$\text{ThSiO}_4$	25.2–62.7	Langesundfjord (Norway)
Orangite	$\text{ThSiO}_4$		Madagascar, Idaho
Huttonite	$\text{ThSiO}_4$		New Zealand
Uranothorite	$(\text{U}, \text{Th})\text{SiO}_4$	20–42	Mid-Norway, Blind River (Canada)
Cheralite	$(\text{Ce}, \text{La}, \text{Pr}, \text{Nd}, \text{Th}, \text{Ca}, \text{U})(\text{PO}_4, \text{SiO}_4)$	25.9–27.7	Travancore (India)
Monazite	$(\text{Ca}, \text{La}, \text{Y}, \text{Th})\text{PO}_4$	3–26	India, Brazil, and most other deposits
Thorogummite	$\text{Th}(\text{SiO}_4)_{1-2}(\text{OH})_2$	18.2–50.8	Brazil, Jisaka (Japan)
Tscheffkinitite	silicates of RE, Fe, Mn, Mg, Ca, Al, Ti, Th, U	$\leq 18.4$	Madagascar
Pilbarite	$\text{PbO} \cdot \text{UO}_3 \cdot \text{ThO}_2 \cdot 2\text{SiO}_2 \cdot 4\text{H}_2\text{O}$	$\leq 27.4$	Western Australia
Allanite	$(\text{Ca}, \text{Ce}, \text{Th})_2(\text{Al}, \text{Fe}, \text{Mn}, \text{Mg})_3(\text{SiO}_4)_3\text{OH}$	$\leq 3.2$	Montana, Sri Lanka
<b>Niobates/tantalates</b>			
Pyrochlore	$(\text{Na}_4, \text{Ca}_2, \text{U}, \text{Th})(\text{Nb}, \text{Ta})_4\text{O}_{12}$	$\leq 10$	Colorado
Euxenite	$(\text{Y}, \text{Ca}, \text{Ce}, \text{U}, \text{Th})(\text{Nb}, \text{Ta}, \text{Ti})_2\text{O}_6$	$\leq 4.5$	Western Australia, Nigeria

Table 42.4: Composition of monazite concentrates (in %).

Constituent	India	Brazil	Florida beach sand <sup>a</sup>	South Africa Monazite Rock	Malagasy Republic
$\text{ThO}_2$	8.88	6.5	3.1	5.9	8.75
$\text{U}_3\text{O}_8$	0.35	0.17	0.47	0.12	0.41
$(\text{RE})_2\text{O}_3^b$	59.37	59.2	40.7	46.41	46.2
$\text{Ce}_2\text{O}_3$	(28.46)	(26.8)		(24.9)	(23.2)
$\text{P}_2\text{O}_5$	27.03	26.0	19.3	27.0	20.0
$\text{Fe}_2\text{O}_3$	0.32	0.51	4.47	4.5	
$\text{TiO}_2$	0.36	1.75		0.42	2.2
$\text{SiO}_2$	1.00	2.2	8.3	3.3	6.7

<sup>a</sup>Florida beach sand contains about 70% monazite.

<sup>b</sup>Rare earth oxides, including  $\text{Ce}_2\text{O}_3$ .

The currently known and extracted deposits amounting to ca.  $1.3 \times 10^6$  t are in India and Malaysia (30%); Egypt (20%); Canada and the United States (15%); and Brazil, Russia, and Australia (5%); the remainder is in Indonesia, Nigeria, Nyasaland, and South Africa. These deposits can meet the demand for the foreseeable future, so new deposits are not being sought.

The largest mining areas are in India in the province of Travancore, where the coastal sands over a distance of > 70 km contain monazite in the form of honey-yellow grains up to several millimeters in size.

The sands are usually subjected first to simple gravity concentration, which yields a concentrate containing 65–80% ilmenite ( $\text{FeTiO}_3$ ), 3–6% rutile ( $\text{TiO}_2$ ), zircon ( $\text{ZrSiO}_4$ ), 1–5% sillimanite ( $\text{Al}_2\text{SiO}_5$ ), and garnet [ $\text{Fe, Ca, Mg}_3\text{Al}_2\text{SiO}_4$ ], as well as some cassiterite ( $\text{SnO}_2$ ) and a small amount of gold, together with 0.5–1% monazite.

## 42.4 Production [13]

The principal production stages are the concentration of thorium minerals, extraction of thorium from them, purification, and conversion to the metal or desired compounds, usually  $\text{ThO}_2$ . Whereas up to 0.2% impurities, including rare earths, have no detrimental effects on conventional applications, nuclear technology demands a much lower level of impurities (by one or more orders of magnitude), especially of neutron-absorbing elements such as rare earths and boron, for which additional purification processes have been developed.

### 42.4.1 Concentration

#### 42.4.1.1 Ore Preparation

The methods used for ore concentration are different for primary and secondary deposits. The process used by Molybdenum Corp. in the United States is described here as a typical example of beneficiation of a primary deposit. The pegmatites, which are usually obtained by

mining, are first coarsely and then finely ground. The ores are then subjected to a flotation process at 60 °C. This gives a 63% concentrate of rare earths and thorium. The alkaline-earth carbonates are dissolved out of this with HCl, further concentrating the ore to 73%. Thickening, filtration, and calcination yield a concentrate containing almost 90% Th and RE suitable for further processing.

For ore preparation from Indian coastal sands (*secondary deposit*), the sand is subjected to gravity separation on dredges just off the coast; i.e., the sand that is collected from the seabed is wet sorted in batteries of separators. Alternatively, after removal of the coarse fraction, the sand is sorted in a dry state on the coast. The second step is magnetic sorting using a series of magnets of increasing strength. Magnetite and ilmenite are first removed by the weakest magnets; garnet is removed by magnets of the next higher strength; and coarse and fine monazite is successively removed in the next two stages, the paramagnetism of monazite being due to its rare-earth content. The monazite concentrate obtained has a purity of up to 98%. Nonmagnetic residues are then usually treated by flotation to recover rutile, zircon, and gold, which are valuable by-products.

#### 42.4.1.2 Ore Digestion and Thorium Recovery

Monazite is fairly inert chemically. The industrial chemical ore digestion process, which was started in the last century, was first based on the simplest possible methods (i.e., treatment with hot, concentrated sulfuric acid in cast iron vessels, followed by selective precipitation by dilution with water). Because of the low rate of solution and the simultaneous presence of rare earths, thorium, and the complexing ions phosphate and sulfate in the solution, only slight variation in operation was possible, and success depended on following the formulations precisely and also on the composition and grain size of the monazite. A number of other processes were therefore developed to avoid these problems. For eco-

nomics reasons, the only successful alternative method was to use alkaline digestion with hot sodium hydroxide solution. Although the process itself is a little more expensive than acid digestion, it removes phosphate and is therefore more suitable as a first stage before extractive separation to produce high-purity thorium. After some process development, it has been used mainly in the United States, India, and Brazil, where one of the target products is (or was) thorium of nuclear purity [14].

### Acid Digestion

Digestion with sulfuric acid is usually carried out in two stages with 93% acid at 210–230 °C (see Figure 42.6). In the first stage, in which an acid excess of ca. 60% is used, the reaction mixture thickens as reaction products are formed—first to a slurry and then to a solid gray mass. Then, fuming sulfuric acid is added, and treatment is continued for additional 5 h at the same temperature. The acid concentration chosen is the result of a compromise between the reaction rate (which increases with concentration) and the viscosity (which also increases with concentration, thereby retarding the reaction). The completeness of the reaction depends on the grain size of the monazite sand, sand:acid ratio, temperature, and reaction time. Unfortunately, increasing the reaction temperature to 300 °C brings a risk of formation of insoluble thorium pyrophosphate and must therefore be avoided. Since the dissolution reaction is strongly exothermic, an upper limit exists to the rate of addition of monazite to the acid. In contrast, below 200 °C the reaction proceeds too slowly. If stoichiometric amounts of sand and acid could be used, the required amount of acid added would be only 60% of the sand mass. However, to keep the salts formed in solution and prevent blockage of the reactive surface of sand by the formation of precipitates, the mass of acid used must be twice the mass of sand (see Figure 42.7). To reduce acid consumption, reaction times of > 5 h are used to minimize the volume of solution after dilution. After the pasty mixture is cooled to 70 °C, it is diluted

with ten times its volume of cold water. The salts of rare earths and thorium remain in solution, while undissolved monazite rapidly settles out because of its high density. This can be recycled, and the finer and lower-density gangue materials are filtered off.

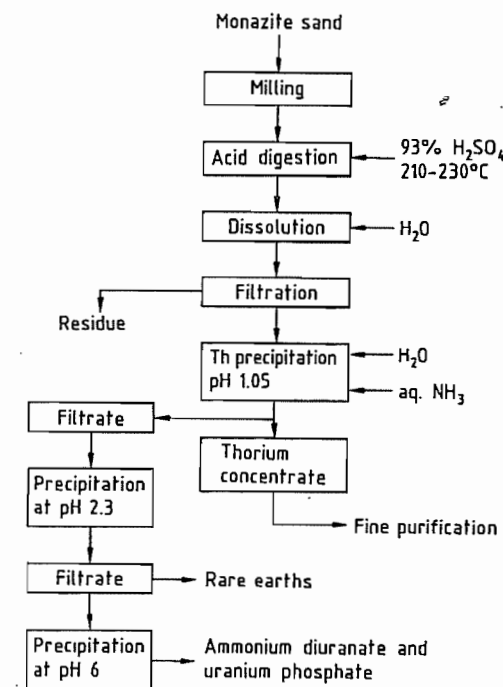

Figure 42.6: Digestion with sulfuric acid and thorium concentration.

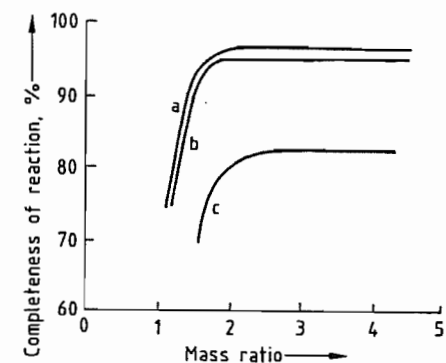

Figure 42.7: Effect of mass ratio of  $\text{H}_2\text{SO}_4$ :monazite sand at 300 °C and 30-min digestion on completeness of reaction: a) Completeness of reaction of thorium fraction; b) Completeness of reaction of sand (overall); c) Completeness of reaction of uranium fraction.

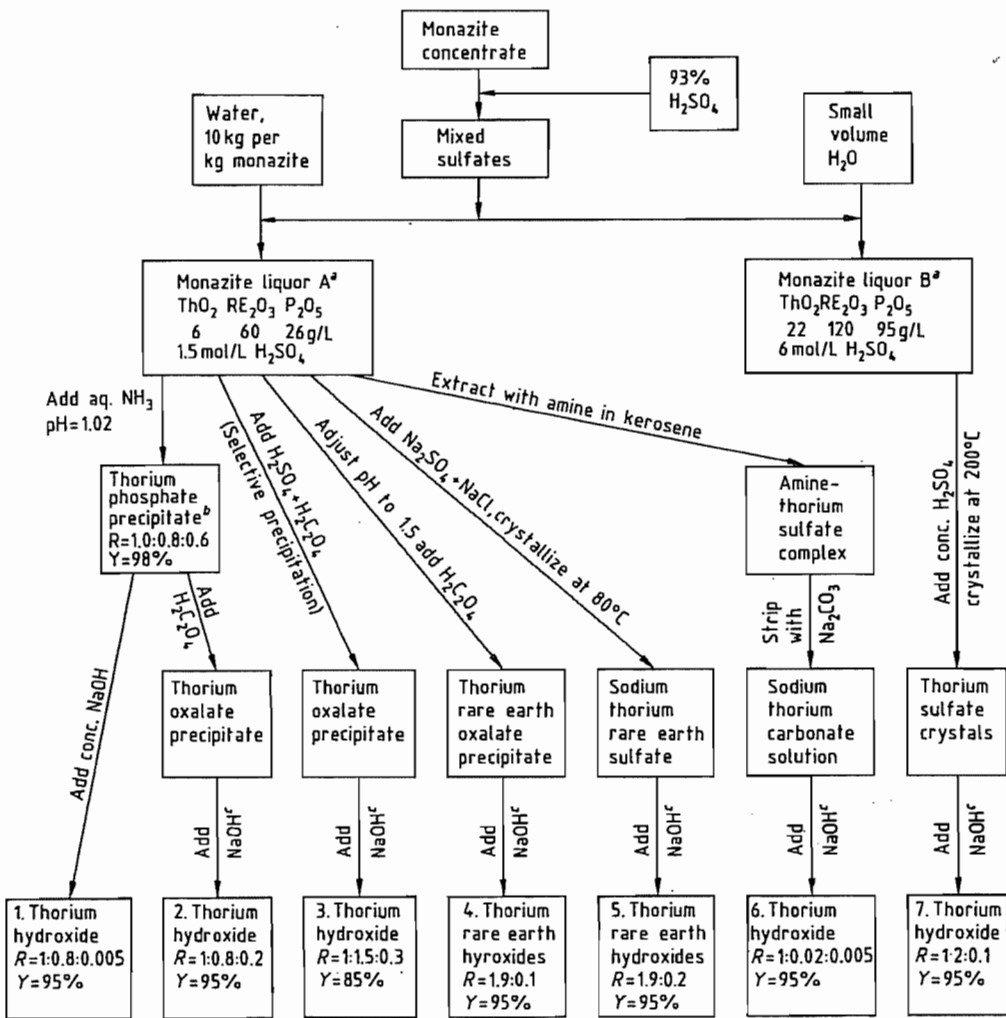

Figure 42.8: Principal processes for extracting thorium from monazite acid leach solution. R = Mass ratio ThO<sub>2</sub>:RE<sub>2</sub>O<sub>3</sub>:P<sub>2</sub>O<sub>5</sub>; Y = Approximate overall ThO<sub>2</sub> yield in concentrate. <sup>a</sup> Filtered. <sup>b</sup> Washed. <sup>c</sup> 10% excess.

The subsequent separation of thorium and rare earths is based on the fact that thorium is almost completely precipitated as phosphate at pH values of ca. 1.3, while the main quantity of rare earths is precipitated later at a pH of ca. 2. Neutralizing agents such as sodium carbonate and ammonia must be added slowly and distributed homogeneously so that the pH limit is never exceeded, thus preventing local precipitation of rare earths, which do not redissolve. Furthermore, the slow rate of precip-

itation and the occlusive properties of the finely divided thorium precipitate must be kept in mind. The most uniform results would be obtained by diluting with pure water, but this is ruled out for practical reasons (i.e., excessive volume increase).

If the solution contains much uranium, simultaneous precipitation of thorium and rare earths by oxalic acid can be used—a selective, but expensive method of separation. Attempts have also been made to precipitate the rare

earths first as double sulfates by adding sodium sulfate; to selectively precipitate thorium along with uranium from the solution as peroxides; or to precipitate rare earths from the concentrated solution by phosphoric acid and then evaporate the solvent to achieve precipitation of thorium as a double salt (sulfate-phosphate) [15].

An overview of the principal proven process variations is given in Figure 42.8. None of the processes is sufficiently selective to be used without subsequent removal of the rare earths from thorium and vice versa. Also, sometimes one or more rare earths are the most marketable products and sometimes thorium is, the purity requirements being different in each case.

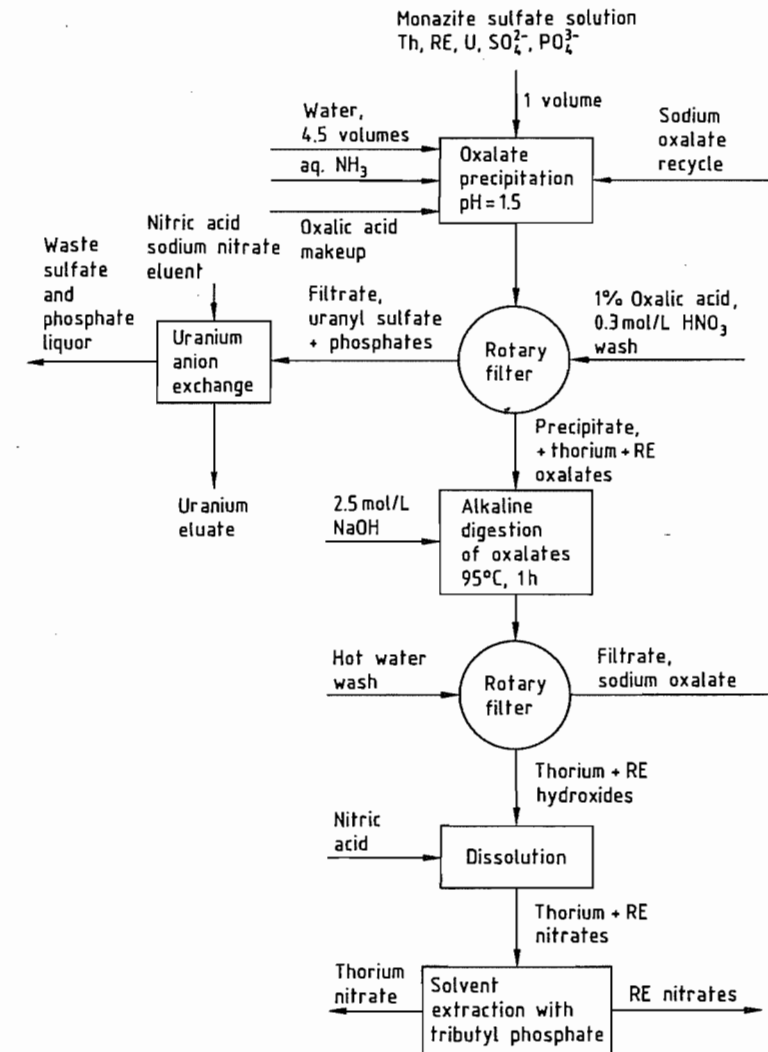

Figure 42.9: Iowa process for separating thorium, rare earths, and uranium from monazite sulfate.

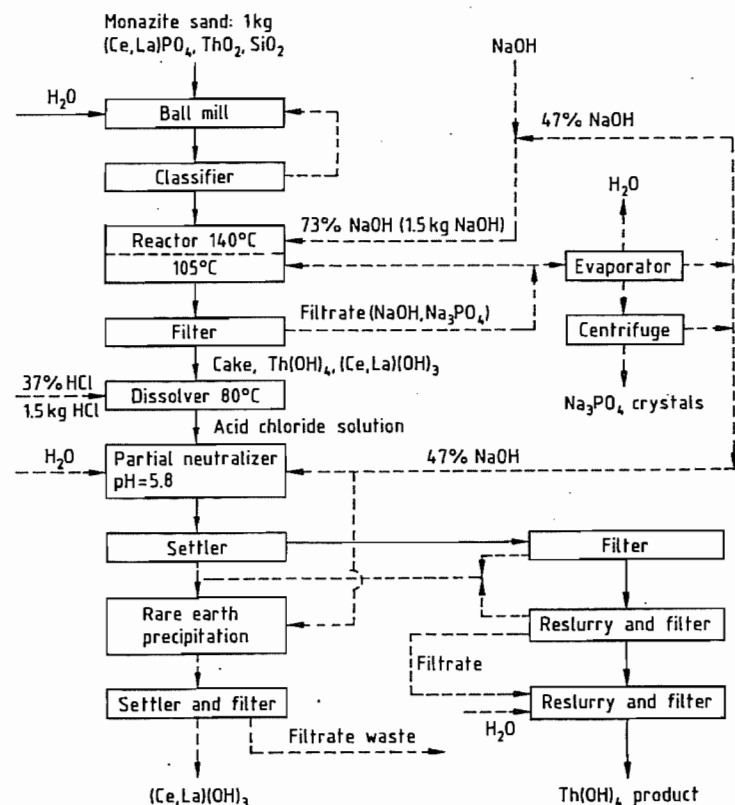

Figure 42.10: Caustic soda process for recovery of thorium from monazite.

In the early 1950s, interest in thorium of nuclear purity suddenly increased in the United States. This led to the development of the Iowa process in the Ames Laboratories of the USAEC [16] in which  $\text{H}_2\text{SO}_4$  digestion was linked with purification by solvent extraction of the Th and RE nitrates with TBP. After acid digestion, phosphate and sulfate were removed by oxalate precipitation; the oxalates were digested with alkali to form hydroxide precipitates, which were subsequently dissolved in  $\text{HNO}_3$ . The process was functionally reliable, but expensive, and produced a number of waste streams (variation 4 in Figure 42.8, with details in Figure 42.9).

### Alkaline Digestion

As with acid digestion, treatment with sodium hydroxide solution (Figure 42.10) is lim-

ited by a number of factors. If the temperature is too high, a difficultly soluble thorium oxide is formed and too much uranium appears in the filtrate. If alkali concentrations are too low, the dissolution process takes too long. The optimum values appear to be 30–45% sodium hydroxide solution at ca. 140 °C and a reaction time of 3 h. However, these comparatively mild reaction conditions require finely ground monazite sand (particle size < 45  $\mu\text{m}$ ) to ensure adequate reaction. After filtration the filter cake contains rare earths and thorium as hydroxides and uranium as sodium diuranate; all of the phosphate is present in solution in the filtrate as trisodium phosphate. On cooling this below 60 °C,  $\text{Na}_3\text{PO}_4 \cdot 10\text{H}_2\text{O}$  crystallizes. The uranium content of trisodium phosphate increases with the amount of dissolved  $\text{SiO}_2$ , and it must be recrystallized before it becomes a saleable by-product.

Table 42.5: Distribution coefficients for uranium, thorium, and cerium between organic amines and aqueous sulfate solution.

Amine type	Examples of amines	Distribution coefficient <sup>a</sup>		
		U(VI)	Th(IV)	Ce(III)
Branched primary	primary JM <sup>b</sup> and 1-(3-ethylpentyl)-4-ethyloctylamine	5–30	> 20 000	10–20
Secondary with alkyl branching distant from the nitrogen	di(tridecyl)amine <sup>c</sup>	80	> 500	< 0.1
Secondary with alkyl branching on the first C	amberlite LA-1 <sup>d</sup> and bis(1-isobutyl-3,5-dimethylhexyl)amine	80–120	5–15	< 0.05
Tertiary with no branching or branching no closer than the third C	alamine 336 <sup>e,f</sup> and triisooctylamine <sup>g,h</sup>	140	< 0.03	< 0.01

<sup>a</sup> 0.1 mol/L  $\text{SO}_4^{2-}$ ; pH = 1; = 1 g metal per liter; 0.1 mol/L amine in kerosene; 1:1 phase ratio.

<sup>b</sup> Trialkylmethylamine, homologous mixture, 18–24 carbons.

<sup>c</sup> Mixed  $\text{C}_{13}$  alkyls from tetrapropylene by oxo process.

<sup>d</sup> Dodecyltrialkylmethylamine, homologous mixture, 24–27 carbons.

<sup>e</sup> Trialkylamine with mixed *n*-octyl and *n*-decyl radicals.

<sup>f</sup> Kerosene diluent modified with 3 vol% tridecanol.

<sup>g</sup> Mixed  $\text{C}_8$  alkyls from oxo process.

The hydroxides are dissolved in 37% HCl at 80 °C. After filtering off the undissolved material, 47% NaOH is added, and thorium along with uranium almost completely precipitates at pH 5.8. However, the alkaline filter cake must not be completely dried; otherwise, some  $\text{Ce}^{4+}$  is formed by contact with air, and this liberates chlorine from HCl. The rare earths are precipitated by further increasing the pH. Neutralization can be carried out with NaOH residues from the filtrate from alkaline digestion, provided concentrations of phosphate are low enough as not to precipitate insoluble RE phosphates.

If thorium and uranium are to be separated from rare earths by solvent extraction, the filter cake from alkaline digestion is preferably dissolved immediately in  $\text{HNO}_3$ . However, complete dissolution of thorium cannot always be guaranteed, especially in the presence of titanium hydroxides, which bind large amounts of thorium. The good solubility of  $\text{ThO}_2$  at 10 bar and 230 °C in  $\text{HNO}_3$  was only discovered in 1986 [17], and has hitherto not yet been utilized on an industrial scale.

### 42.4.2 Fine Purification by Solvent Extraction

In recent decades, purification of chemically similar substances by techniques involving repeated transitions between solid and liquid phases has been replaced by technologi-

cally simpler liquid–liquid extractions. At the same time, purity requirements for thorium and its compounds have become more strict. Especially in nuclear technology, concentrations of elements with a high parasitic neutron capture cross section must be low. (For example, the maximum permitted concentrations equivalent to 4 mg/kg boron are only 8 mg/kg Sm, 2 mg/kg Er, or 1 mg/kg Gd.) Thus, the process of multiple solution and precipitation or recrystallization to separate rare earths from each other or from thorium and uranium has been replaced by multistage countercurrent solvent extraction methods. However, to give suitable distribution coefficients between the aqueous and organic systems, the chemical bonding of the ions that take part in the exchange must not be too different in the two systems. Thus, stable complexes of thorium and uranium that are soluble only in water, especially those with sulfate and phosphate ions, are unsuitable.

Hence, attempts to extract thorium and uranium directly from monazite sulfate solutions with TBP in organic solution were unsuccessful. Only the use of extraction media with strongly cationic character enabled successful extraction from these solutions to be carried out. Whereas the anionic character of  $\text{UO}_2^{2+}$  is strong enough for it to bond to quaternary nitrogen (in amines dissolved in organic solvents), the situation is less favorable in the

case of Th<sup>4+</sup>. Some distribution coefficients are given in Table 42.5, which also shows the clear difference between thorium and uranium. This difference favors branched primary amines.

**Amex Process.** The use of a combination of different amines in three consecutive cycles (see Figure 42.11) is the basis of the prototype scale Amex process [18], which enables pure products (U, Th, RE) to be obtained directly from diluted solutions of monazite in sulfuric acid. However, in the absence of any large demand, this flow scheme has not yet been tested on a full scale.

**Solvent Extraction with TBP.** In the absence of phosphate ions (e.g., in the case of oxidic and carbonate-containing thorium ores) or if phosphate ions have been previously removed in the alkaline treatment method, the U, Th,

and RE nitrate complexes can be separated and purified by extraction with TBP in an organic solvent, preferably in kerosene. The overall process is simple and easily controlled. The effect of the molarity of nitric acid on the distribution coefficients of rare earths, uranium, and thorium is shown in Figure 42.12. With a mean acid concentration of 3 mol/L, the distribution coefficient\* (organic/aqueous) for rare earths is 0.02, for thorium 1, and for uranium 20, so that a multistage separation is possible [19]. Trivalent metallic ions such as Fe<sup>3+</sup> can mask residues of phosphate. A suitable flow scheme is shown in Figure 42.13. Solvent extraction, which is optional in the purification of natural thorium compounds, is the only feasible method of separating thorium, <sup>233</sup>U, and fission products after irradiation in a reactor.

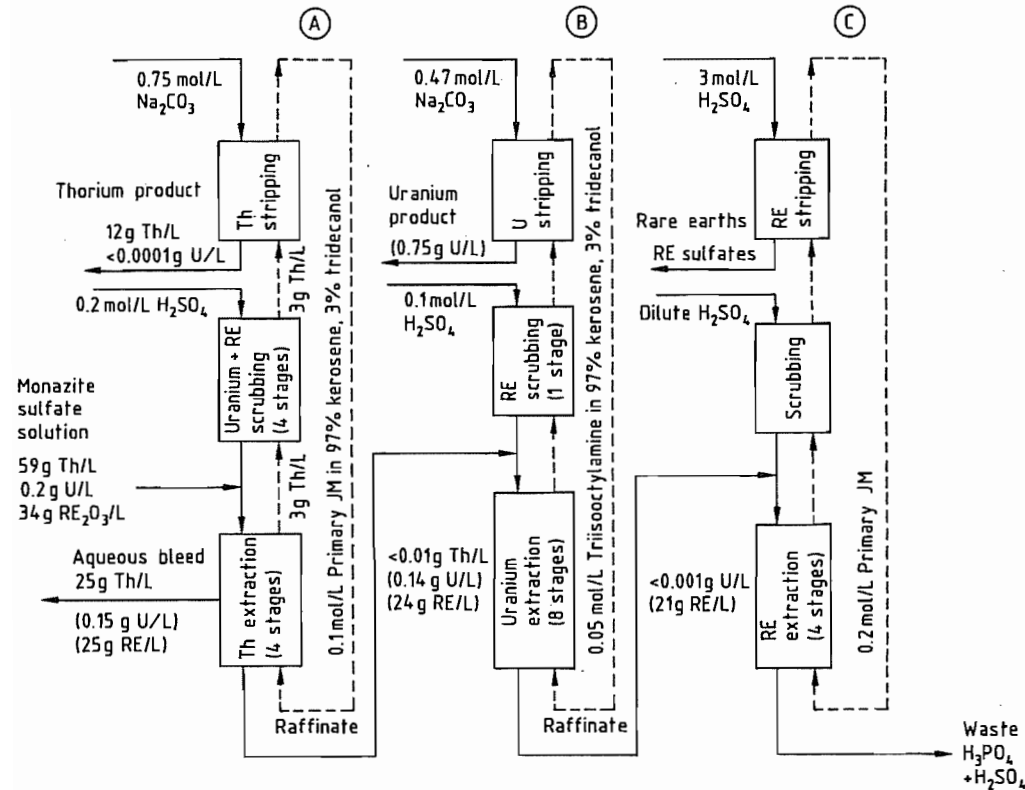

Figure 42.11: Separation of thorium, uranium, and rare earths from monazite by solvent extraction in Amex process. A) Thorium separation; B) Uranium separation; C) Rare earth separation.

Canadian Blind River district), thorium is extracted with di(2-ethylhexyl)phosphoric acid.

## 42.5 Compounds

### 42.5.1 Oxides [20]

Two compounds, ThO and ThO<sub>2</sub>, exist in the oxygen–thorium system. The black compound ThO, which crystallizes with the sodium chloride lattice, is known only from coatings on the metal. It is probably an interstitial compound with an electron deficit structure. When ThO<sub>2</sub> is heated in an electric arc, ThO band structures appear in the spectrum.

The compound ThO<sub>2</sub> is the stable, well-known oxide, being formed if either a salt that contains a volatile anion or the oxidaquate is strongly heated. It is obtained as a very fine powder by precipitating and then strongly heating thorium oxalate, according to

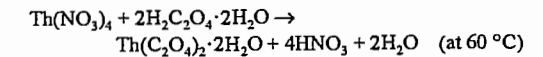

and

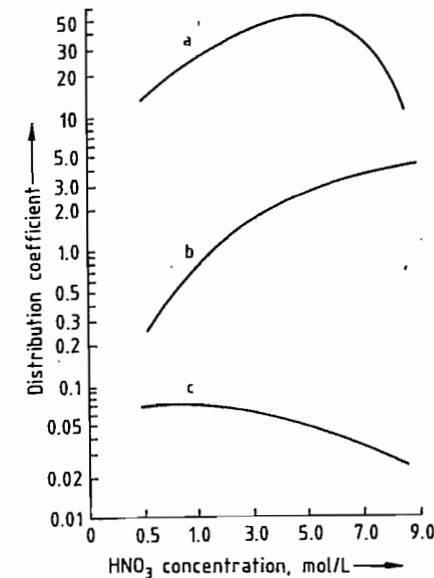
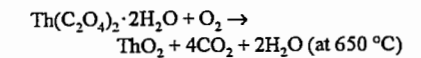

Figure 42.12: Effect of acid molarity on distribution coefficients (organic–aqueous phase) of nitrate complexes in TBP–kerosene extraction: a) Uranium; b) Thorium; c) Rare earths.

In an intermediate route that can be used in the presence of high concentrations of sulfate but in the absence of phosphate (e.g., in residual solutions from uranium extraction in the

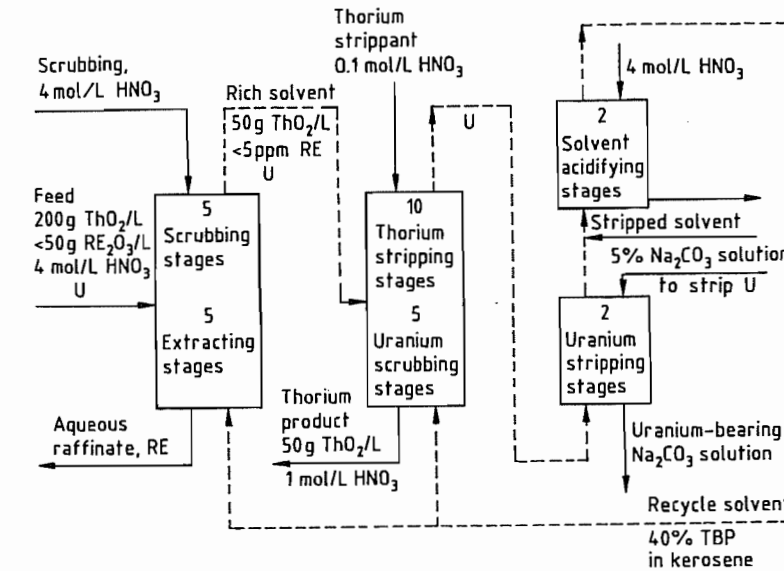

Figure 42.13: Thorium purification by solvent extraction with TBP — Aqueous phase; --- 40 vol% TBP in kerosene.

At pH 1 and with careful temperature control, the reaction with oxalic acid leads to a crystalline precipitate with good filtering properties. Precipitation can be carried out selectively also in the presence of trivalent metals, uranium, and titanium. Several other 1,2-dicarboxylic acids have been tested as alternatives, but only tetrachlorophthalic acid gave significantly improved selectivity against the rare earths [21].

The structure, decomposition temperature used, and calcination temperature can affect the rate of reaction of  $\text{ThO}_2$  in other reactions. For example,  $\text{ThO}_2$  freshly prepared by low-temperature thermal decomposition of thorium oxalate (meta- $\text{ThO}_2$ ) is catalytically active and fairly soluble in acids, whereas thorium oxide calcined at high temperature is very slowly attacked by acids. It can be dissolved only in hot, concentrated  $\text{H}_2\text{SO}_4$  or in concentrated  $\text{HNO}_3$  in the presence of  $\text{F}^-$  ions. Physical properties of  $\text{ThO}_2$  are listed below [22]:

Color	white
Crystal system	face-centered cubic
Density (X ray, 25 °C)	10.00 g/cm <sup>3</sup>
Linear expansion from 25 °C	$9 \times 10^{-3}$ at 1000 °C $20 \times 10^{-3}$ at 2000 °C
Thermal conductivity (100 °C) (600 °C)	0.10 Wcm <sup>-1</sup> K <sup>-1</sup> 0.04
Melting point	3370 ± 30 °C
Entropy (25 °C)	65.3 JK <sup>-1</sup> mol <sup>-1</sup>
Heat of formation from elements (25 °C)	-1227.6 kJ/mol
Free energy of formation from elements (25 °C)	-1170.0 kJ/mol

The vapor pressure (atm) between 2180 and 2865 K can be calculated according to:

$$\log p = 8.00 - 3517/T$$

( $\text{ThO}_2$  dissociates partially into  $\text{ThO}$  and  $\text{O}$ ; at low oxygen pressure the vapor pressure is somewhat higher.) The temperature dependence of the molar heat capacity (J/mol) between 298 and 3000 K is

$$C_p = 69.3 + 9.71 \times 10^{-3}T - 9.19 \times 10^{-5}T^2$$

Two crystal forms are known, i.e., a tetragonal modification similar to rutile that crystallizes from borate melts and a cubic form that crystallizes from phosphate melts. The lattice constants and densities are very similar

to those of the metal since the oxygen occupies interstitial locations. However, these densities are not reached by sintered oxides (maximum values: ca. 10.2 g/cm<sup>3</sup>). Thorium dioxide melts at 3370 °C and thus has the highest melting point of all ceramic materials. The tendency of meta- $\text{ThO}_2$  to form colloidal solutions (thorium oxidaquate) in the presence of nitrate ions is important, because these can be dried to form stable gels that can be sintered to give high-density ceramic bodies. Another important property of  $\text{ThO}_2$  is the emission of long-wave red light on heating (a historical test of purity), and the shifting of the emitted wavelength further into the visible region by the addition of rare earths, especially cerium, which is an essential feature of gas mantle technology (see Section 42.9.2 for further details).

Coatings of  $\text{ThO}_2$  on tungsten are used to promote the emission of electrons from incandescent cathodes. These coatings must be thin and uniform; they are produced by a simple process of dipping the cathodes into suspensions of thorium oxidaquate and various finely dispersed thorium oxide slurries or by electrophoretic deposition of the oxide from alcoholic suspensions. They must be "formed" by heating the cathodes to 2900–3000 °C.

Thorium oxide forms mixed crystals with a number of oxides of the actinides (e.g., U, Np, and Pu), with no miscibility gap. No phase transformation occurs up to the melting point.

When  $\text{ThO}_2$  is used to form ceramics, for dimensional accuracy of the preformed bodies (crucibles, nuclear fuel pellets) the powders used must shrink by a small but definite amount during sintering/densification. Choice of the powder involves a compromise between less good sintering properties and minimized shrinkage. The meta- $\text{ThO}_2$  is preferably precalcined in an atmosphere of steam at 800–1000 °C before it is formed by pressing or slip casting. The effect of precipitation temperature and calcination temperature on the specific surface area of the powder is shown in Figure 42.14 [23].

Table 42.6: Physical properties of thorium tetrahalides.

Property	$\text{ThF}_4$	$\text{ThCl}_4$	$\text{ThBr}_4$	$\text{ThI}_4$
Color	white	white	white	yellow
Density at 25 °C, g/cm <sup>3</sup>	6.12	4.62	5.72	6.00
Crystal system				
Low-temperature form	monoclinic	tetragonal	orthorhombic	monoclinic
High-temperature form		orthorhombic	tetragonal	orthorhombic
Transition temperature, °C		(406)	≈ 420	?
Melting temperature, °C	1110	770	679	570
Normal boiling point, °C	1782	942	905	853
Vapor pressure, atm				
$\log p = A - B/T$				
Solid, A	9.345	9.426	9.498	9.747
B, K	17 089	10 630	10 151	9894
Liquid, A	6.395	5.229	5.260	5.714
B, K	13 080	6346	6187	6425
Heat capacity, $C_p = A + 10^{-3}BT - 10^{-5}CT^2$				
Solid, A, Jmol <sup>-1</sup> K <sup>-1</sup>	112.0	120.4	127.7	129.8
B, Jmol <sup>-1</sup> K <sup>-1</sup>	24.51	23.84	15.1	13.0
C, Jmol <sup>-1</sup> K <sup>-1</sup>	7.56	6.15	6.15	6.15
Liquid, Jmol <sup>-1</sup> K <sup>-1</sup>	152.8	167.5	171.7	175.9
Heat of transition, J/mol		5.02	4.2	?
Heat of fusion, kJ/mol	44.0	61.5	(54.4)	48.1
Heat of vaporization at normal boiling point, kJ/mol	233.2	?	111.0	115.1
Heat of formation at 25 °C, kJ/mol	-2112.8	-1187.4	-966.3	-664.9
Free energy of formation $\Delta G = A + BT$				
Solid, A, kJ/mol	-2102.5	-1177.0	-1019.3	-783.1
Solid, B, Jmol <sup>-1</sup> K <sup>-1</sup>	293.6		283.5	290.8
Liquid, A, kJ/mol	-2031.0	-1093.3	-942.9	-716.0
B, Jmol <sup>-1</sup> K <sup>-1</sup>	240.3	201.4	211.7	210.4

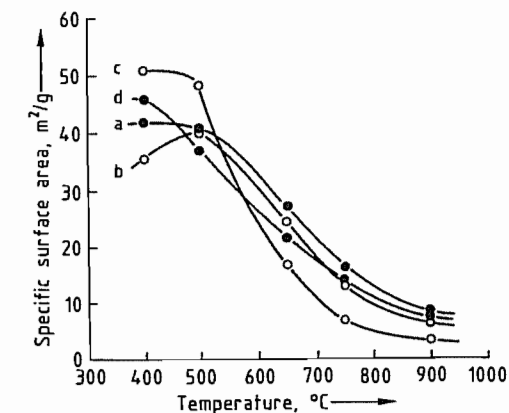

Figure 42.14: Effect of temperature on the specific surface of thorium oxide from thermal decomposition of thorium oxalate: a) 40% Precipitation; b) 10% Precipitation; c) 100% Precipitation; d) 70% Precipitation.

## 42.5.2 Halides

An overview of the properties of thorium halides is given in Table 42.6.

### 42.5.2.1 Tetrafluoride

Precipitation of thorium salt solutions with HF leads to the formation of gelatinous, white precipitates of  $\text{ThF}_4$  hydrates with 8, 4, or 2 molecules of water of crystallization, but these hydrolyze to form mixtures of  $\text{ThO}_2$  and  $\text{ThOF}_2$  even on careful drying. Anhydrous  $\text{ThF}_4$  can be obtained only by fuming  $\text{ThF}_4$  hydrates many times with  $\text{NH}_4\text{F}$  or by dehydration in a stream of dry HF at 300–400 °C. Thorium tetrafluoride is therefore produced industrially by reaction of  $\text{ThO}_2$  and HF in the gas phase:

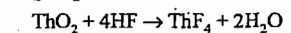

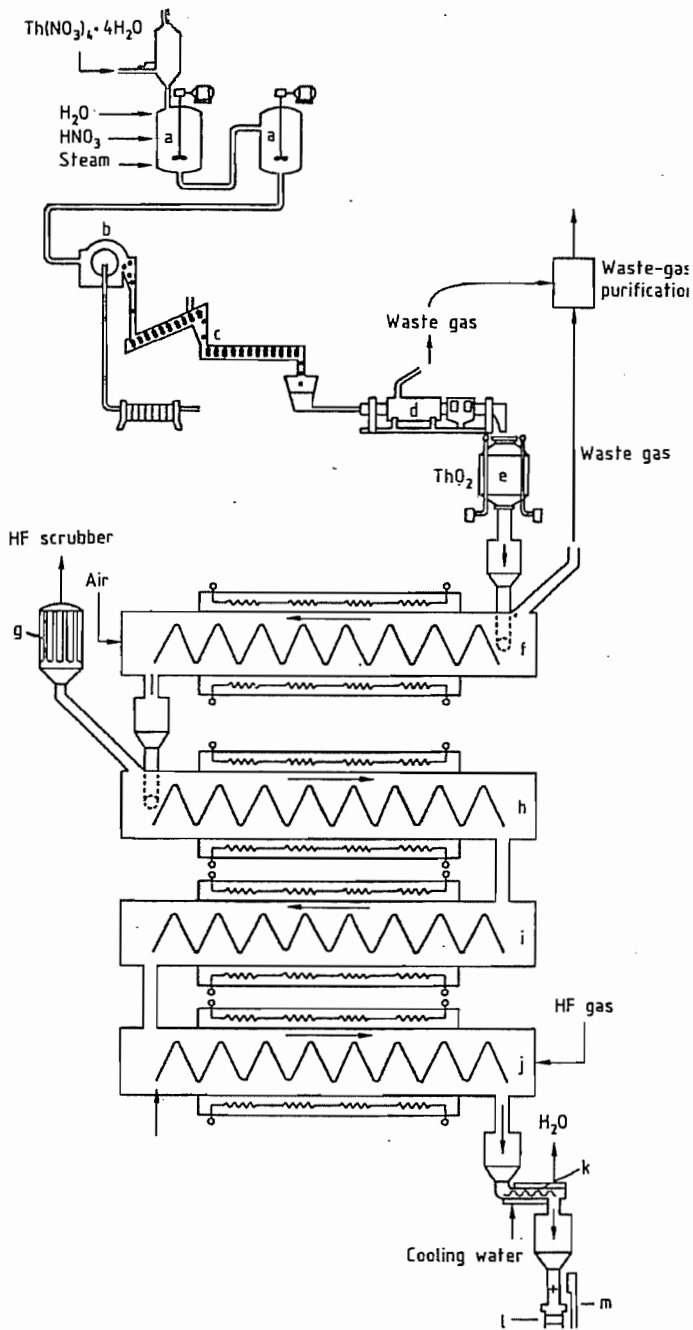

**Figure 42.15:** Production of  $\text{ThF}_4$  by calcination and fluorination: a) Thorium oxalate precipitation; b) Drum filter to filter off  $\text{Th}(\text{C}_2\text{O}_4)_2$ ; c) Band dryer; d) Calcination; e) Weighing; f) Calcination ( $650\text{--}675\text{ }^\circ\text{C}$ ); g) HF scrubber; h) Hydrofluorination ( $370\text{ }^\circ\text{C}$ ); i) Hydrofluorination ( $370\text{ }^\circ\text{C}$ ); j) Hydrofluorination ( $566\text{ }^\circ\text{C}$ ); k) Cooling trough; l)  $\text{ThF}_4$  collector; m) Weighing.

At  $566\text{ }^\circ\text{C}$  the reaction is exothermic and at first proceeds rapidly, but thermodynamic equilibrium is attained very quickly, leaving an unreacted excess of HF. At lower temperature, the reaction goes to completion but proceeds much more slowly. A schematic of the production of thorium fluoride from the nitrate via the oxalate, as carried out by the National Lead Company (Fernald, Ohio), is shown in Figure 42.15 [11, p. 153]. The plant consists of four stainless steel tubular reactors arranged in series, each provided with exterior heating and interior screw conveyors made of Inconel. A countercurrent flow system with graded temperature increases utilizes HF to give complete conversion of  $\text{ThO}_2$ . However, to obtain  $\text{ThF}_4$  that does not contain oxide-fluoride, it was necessary to use excess anhydrous HF and produce and sell by-product aqueous HF (70%). New plants will probably be operated as fluidized-bed reactors following experience with uranium.

Thorium tetrafluoride is formed as a solid residue when enriched  $^{235}\text{UF}_6$  is stored. The  $^{234}\text{U}$  contained in uranium, which is also enriched, decays to form  $^{230}\text{ThF}_4$ . This remains behind after steaming out the  $\text{UF}_6$  container and must be scrupulously removed because of its high  $\alpha$ -toxicity.

In the electrolytic production of thorium from a fluoride melt, the double fluoride  $\text{KThF}_5$  can be used as the starting material. The  $\text{KThF}_5$  can be precipitated by adding KF to a solution of thorium nitrate according to

$$\text{Th}(\text{NO}_3)_4 \cdot 4\text{H}_2\text{O} + 5\text{KF} \cdot 2\text{H}_2\text{O} \rightarrow \text{KThF}_5 + 4\text{KNO}_3 + 6\text{H}_2\text{O}$$

and is dried at  $120\text{ }^\circ\text{C}$  to give a product free of water of crystallization.

#### 42.5.2.2 Tetrachloride

Depending on conditions, thorium tetrachloride crystallizes from aqueous solution with 11, 9, 8, 7, 4, or 2 molecules of water of crystallization, but oxide-chlorides are formed on drying. Anhydrous  $\text{ThCl}_4$ , like anhydrous  $\text{ThF}_4$ , can be produced only by reaction in the gas phase. All reactions that simultaneously reduce and chlorinate  $\text{ThO}_2$

are suitable (see overview in Table 42.7), for example, chlorination of a mixture of  $\text{ThO}_2$  and C above  $600\text{ }^\circ\text{C}$ :

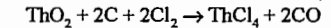

**Table 42.7:** Reaction of chlorine and  $\text{ThO}_2$  with reducing agents.

$\text{ThO}_2$ type	Reducing agent	Temp., $^\circ\text{C}$	Time, h	Yield, %
$\text{Th}(\text{C}_2\text{O}_4)_2$	carbon	700	2	99
	$\text{CCl}_4$	800	4	10
$\downarrow > 675\text{ }^\circ\text{C}$	sulfur	800	2	98
	$\text{C}_3\text{Cl}_8$	400	5	25
$\text{ThO}_2$	$\text{NH}_4\text{Cl}$	425	4	0
$\text{Th}(\text{C}_2\text{O}_4)_2$	carbon	600	2.5	99
	$\text{CCl}_4$	300	5.5	92
$\downarrow 445\text{ to }525\text{ }^\circ\text{C}$	sulfur	500	3	99
	$\text{C}_3\text{Cl}_8$	400	4	92
$\text{ThO}_2$	$\text{NH}_4\text{Cl}$	500	1.5	99

Because the  $\text{ThCl}_4$  formed contains carbon as an impurity, it must be distilled at  $942\text{ }^\circ\text{C}$ . This step is complex due to the very hygroscopic and aggressive nature of the chloride. Distillation is not necessary if thorium oxalate is chlorinated with  $\text{CCl}_4$  with a small addition of chlorine as a catalyst according to

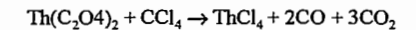

The reaction is carried out at temperatures up to  $525\text{ }^\circ\text{C}$  in several stages in a graphite reactor.

#### 42.5.2.3 Tetraiodide

Thorium tetraiodide has an intense yellow color, an *mp* of  $566\text{ }^\circ\text{C}$ , and a *bp* of  $837\text{ }^\circ\text{C}$ , and can be produced by reaction of the elements. Thorium tetraiodide reacts with excess thorium to give subiodides of trivalent and divalent thorium, depending on the relative amounts of reactants and the temperatures and pressures used. Like the other halides, it can in principle be produced by reaction of intimate mixtures of carbon and  $\text{ThO}_2$  with elementary iodine. In the production of pure metallic thorium, the main use of  $\text{ThI}_4$ , it is not isolated as a separate product but is used only as an intermediate for gas-phase matter transfer between crude and pure thorium in the van Arkel-de Boer process [24].



### 42.5.3 Other Compounds

**Thorium Nitrate.** The compound from which almost all other thorium compounds are produced is thorium nitrate,  $\text{Th}(\text{NO}_3)_4 \cdot 6\text{H}_2\text{O}$ , which is highly soluble in water at room temperature (65%). Evaporation of the aqueous solution yields the tetrahydrate (one of seven hydrates) in the form of a finely crystalline white powder [25].

**Thorium Hydrides.** The hydrides  $\text{ThH}_2$  and  $\text{ThH}_4$  are known. On reduction of  $\text{ThO}_2$  with excess magnesium in the presence of  $\text{H}_2$ , a somewhat substoichiometric, highly flammable powder is formed, which is isomorphic with  $\text{ZrH}_2$  and pseudoisomorphic with  $\text{ZrC}_2$  and  $\text{ThC}_2$ . The other compound, which is also substoichiometric,  $\text{ThH}_{3.75}$ , has a cubic crystal structure that does not resemble that of the metal. Both compounds can be used to produce finely divided thorium metal since they release all their hydrogen at 900 °C. Anhydrous thorium halides can be obtained by reaction of the hydrides with hydrogen halides.

**Thorium hydroxide,**  $\text{Th}(\text{OH})_4$ , is formed by precipitation from solutions of salts by adding alkali. This compound is not a true hydroxide, but an oxidaquate ( $\text{ThO}_2 \cdot x\text{H}_2\text{O}$ ), a stable colloid that remains amorphous up to 340 °C.

**Thorium peroxide,**  $\text{Th}_2\text{O}_7 \cdot 4\text{H}_2\text{O}$ , is formed as a sparingly soluble precipitate when  $\text{H}_2\text{O}_2$  is added to thorium salt solutions. Only the actinides react in this way. The reaction can be used to separate thorium from the rare earths.

**Thorium Nitrides.** The compounds  $\text{Th}_2\text{N}_3$  and  $\text{ThN}$  are known. The first,  $\text{Th}_2\text{N}_3$ , is a hexagonal, dark red compound, which is formed from the elements, and decomposes in the presence of water to form  $\text{NH}_3$  and  $\text{ThO}_2$ .

$\text{ThN}$  has the face-centered cubic structure like the nitrides of uranium, lanthanum, and cerium, in which nitrogen has a quasimetallic character similar to that of carbon.

**Thorium Phosphide and Borides.** The corresponding phosphide  $\text{ThP}_4$  is stable toward all the usual solvents. The two borides  $\text{ThB}_4$  and

$\text{ThB}_6$  are also very stable, hard materials, the latter forming dark red crystals.

**Thorium Carbides.** The mono- and dicarbide exist, although both compounds have a substoichiometric composition (i.e., 0.97 and 1.90). The monocarbide crystallizes with a face-centered cubic structure. The dicarbide is monoclinic up to 1410 °C and tetragonal above this temperature. The densities of  $\text{ThC}$  and  $\text{ThC}_2$  are 9.6 and 8.76, respectively, and the melting points 2500 °C and 2640 °C. Depending on the availability of carbon, the carbides are formed readily from the elements or by reaction of an intimate mixture of graphite and thorium oxide at 1400 °C:

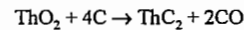

$\text{ThC}$  has a metallic appearance and a thermal conductivity comparable to that of thorium metal. The dicarbide is readily oxidized to  $\text{ThC}$  at high temperature in the presence of oxidic substances. Partial mutual substitution of  $\text{O}_2$ ,  $\text{N}_2$ , and carbon is possible, leading to relatively thermally stable compounds of the type  $\text{Th}(\text{O}_{1-(x+y)}\text{C}_x\text{N}_y)$  when the sum of  $x$  and  $y$  is  $< 0.6$ . The formation of solutions of carbon in thorium is described in Section 42.8.1.

**Thorium sulfides** are not readily formed from aqueous solution, but are formed by reaction of the elements. The compound  $\text{ThS}$ , which has a metallic appearance, is formed first and then converted in several stages to  $\text{ThS}_2$  via the orthorhombic  $\text{Th}_4\text{S}_7$  and other intermediates.

**Thorium sulfate** is important mainly because it is formed when monazite is digested with  $\text{H}_2\text{SO}_4$ . Thorium sulfate forms five different hydrates, which contain up to nine molecules of water of crystallization. Also, sparingly soluble double salts are formed with alkali-metal sulfates.

**Thorium Carbonate.** When thorium salt solutions react with alkali-metal carbonate, a poorly defined basic carbonate of the type  $\text{ThOCO}_3 \cdot 8\text{H}_2\text{O}$  precipitates. It dissolves in an excess of alkali-metal carbonate (similarly to the corresponding uranium) to form relatively stable complex double carbonates of the type

$\text{Na}_6\text{Th}(\text{CO}_3)_5$  or  $(\text{NH}_4)_2\text{Th}(\text{CO}_3)_3 \cdot 6\text{H}_2\text{O}$ . Thorium hydroxide does not precipitate from solutions of these substances.

## 42.6 Production of Pure Thorium Metal

Because of thorium's strongly negative standard electrode potential, its compounds cannot be reduced to the metal with carbon or hydrogen. The route to thorium metal is therefore reaction of the oxide or a halide with metals, electrolysis in molten salts, or thermal decomposition of a halide. The principal reactions that have led to production processes are summarized below:

- Electrolysis of fused salts:
  - $\text{KThF}_5$  in  $\text{NaCl}$
  - $\text{ThF}_4$  in  $\text{NaCl-KCl}$
  - $\text{ThCl}_4$  in  $\text{NaCl-KCl}$
- Reduction with reactive metals:
  - $\text{ThO}_2$  with  $\text{Ca}$
  - $\text{ThCl}_4$  with  $\text{Mg}$
  - $\text{ThF}_4$  with  $\text{Ca}$
- Thermal dissociation of  $\text{ThI}_4$

The results of the processes are listed in Tables 42.8–42.11 [11, pp. 170–171].

The tolerable impurity level of intermediate products to be met when thorium metal is used in the nuclear industry are given in Table 42.12. In the production of thorium metal, problems arose because of its highly reactive nature and sensitivity to both air and moisture, as well as its high melting point (1750 °C). The following four production methods have been tested on a full scale.

**Reduction of  $\text{ThO}_2$  with calcium metal** was first carried out in the United Kingdom at 1200 °C on a pilot plant scale in a reactor lined with  $\text{CaO}$ . In the United States, the reaction was carried out in molten  $\text{CaCl}_2$  in an argon atmosphere to provide a more coarse-grained product, the heat of reaction being insufficient to melt the thorium. Both processes give thorium sponge, which requires many further

processing stages. These production processes were abandoned because of the high temperatures required and the cost of the apparatus.

**Fused Salt Electrolysis.** In fused salt electrolysis,  $\text{KThF}_5$  is used as a 15–20% mixture with  $\text{NaCl}$  to give a eutectic. Thorium is produced in an argon atmosphere as a nonadherent finely crystalline powder deposited on molybdenum cathodes in graphite cells at 900 °C, using a current density of 20 A/dm<sup>2</sup>. In fused salt electrolysis, only  $\text{Cl}_2$  is formed at the anode, and the buildup of thorium powder in the electrolysis vessel causes short circuits. Thus, batchwise operation must be used. A continuous method of operation is possible if  $\text{ThCl}_4$  is used in a mixture of  $\text{NaCl}$  and  $\text{KCl}$  as electrolyte at 800 °C with strict exclusion of moisture. A very pure, coarse-grained thorium metal is obtained. Plants of this type were operated briefly in the United Kingdom, the United States, and the Soviet Union.

**Table 42.8:** Production of thorium metal by reduction of halides or double halides.

Thorium halide	Reducing agent	Product
$\text{ThCl}_4$	Na or K	Th powder
$\text{KThCl}_6$	Na or K under $\text{H}_2$ atmosphere	Th powder
$\text{NH}_4\text{ThCl}_5$	Al	alloy
$\text{ThCl}_4$ (70%) in $\text{ThOCl}_2$ (30%)	Ca	powder
$\text{ThCl}_4$	Mg	powder
$\text{ThCl}_4$	$\text{Na}(\text{Hg})_2$	Th–Hg alloy
$\text{ThF}_4$	Ca with $\text{ZnCl}_2$ booster	Zn–Th alloy biscuit (sponge)

**Table 42.9:** Production of thorium metal by reduction of the oxide.

Thorium source	Reducing agent	Product
$\text{ThO}_2$	Mg	impure alloy
$\text{ThO}_2$	Al	Th beads
$\text{ThO}_2$	Ca	Th powder
$\text{ThO}_2$	Ca and $\text{CaCl}_2$	Th powder

**Table 42.10:** Production of thorium metal by thermal decomposition of halides.

Thorium source	Reducing agent	Product
$\text{ThI}_4$	hot-wire technique	crystal bar of thorium
	$\text{ThI}_4 \xrightarrow{\text{heat}} \text{Th} + 2\text{I}_2$	

Table 42.11: Production of thorium metal by electrolytic methods.

Thorium source	Electrolyte	Product
<b>Aqueous solution</b>		
Th(OH) <sub>4</sub>	HBF <sub>4</sub>	?
Thorium salts	HSO <sub>3</sub> ·NH <sub>2</sub>	?
<b>Organic solution</b>		
Thorium salts	C <sub>2</sub> H <sub>5</sub> OH, CH <sub>3</sub> OH, and other alcohols	thorium organic compounds
Complex Th salts	organic acids	?
Th(NO <sub>3</sub> ) <sub>4</sub>	C <sub>2</sub> H <sub>5</sub> O with 15–20% Me <sub>2</sub> CO <sub>3</sub>	ThO <sub>2</sub>
<b>Fused salt solution</b>		
ThCl <sub>4</sub>	KCl–NaCl	Th with ThO <sub>2</sub> and C
KThF <sub>3</sub>	NaCl–KCl	Th powder
KThF <sub>3</sub>	NaCl	Th powder
ThCl <sub>4</sub>	NaCl and KCl–NaCl	Th powder
ThF <sub>4</sub>	NaCl–KCl	Th powder or Th in liquid Zn cathode

Table 42.12: Typical analyses of pure thorium products.

Element	Th(NO <sub>3</sub> ) <sub>4</sub>	ThO <sub>2</sub>	ThF <sub>4</sub>
Th, % <sup>a</sup>	40.3	86	75.4
U, mg/kg <sup>a</sup>	8	2.5	16.3
Traces, mg/kg <sup>b</sup>			
Al	13	< 10	< 10
B	5.5	0.4	1.2
Ba	< 20		< 20
Be	< 1	< 1	< 1
Bi	< 2	< 2	< 2
Ca	< 200	< 200	
Cd	< 0.2	< 0.2	< 0.2
Co	< 1	< 1	
Cr	< 4	8.1	38
Cu	2	46	81
Fe	26	46	161
Mg	25	8	24
Mn	< 1	2	6
Mo	< 1	< 1	5
Ni	3	15.6	338
P	< 40	< 40	< 40
Pb	2	27	24
SiO <sub>2</sub>	109	207	33
Sn	< 1	6	
V	< 10	< 10	
Zn	< 10	< 10	29

<sup>a</sup> Chemical analysis.<sup>b</sup> Spectrochemical analysis.

**Thermal decomposition of ThI<sub>4</sub>** yields an extremely pure, ductile thorium metal. Thorium iodide is usually produced from impure metal pieces, which are first heated in a muffle furnace to > 500 °C for 24 h in a vacuum, and then reacted with iodine vapor, which is vaporized at 260 °C. Thorium iodide is formed between 450 and 480 °C, and purified by distillation. Thorium metal is deposited from the iodide on incandescent filaments of tungsten

or thorium at 900–1700 °C. The temperature range between 500 and 900 °C must be avoided because the tetraiodide decomposes to form thorium and nonvolatile ThI<sub>3</sub> at a little over 600 °C. The total reaction (formation of ThI<sub>4</sub> and decomposition) is carried out in long, stationary, heated tubes filled with iodine vapor. Concentric perforated sheet metal tubes retain unreacted pieces of crude thorium at the walls of the tube, and pure thorium is deposited on heated filaments at the center. The thickness of the thorium rod that forms in the center is limited only by the electric current used, which eventually reaches several hundred amperes. Both decomposition of the iodide and electrolysis give very pure metal, but these processes do not give high throughputs or yields in the present state of the technology.

**Reduction of Halides.** The larger quantities of thorium metal used in the nuclear industry are produced on an industrial scale mainly by the reduction of halides. The fluoride and chloride are not equivalent, as can be seen from the reaction enthalpies (Table 42.13). Thorium fluoride can be reduced only by calcium, whereas a choice of sodium, calcium, and magnesium exists for the reduction of the chloride. Two processes were developed in the United States almost simultaneously: the reduction of ThCl<sub>4</sub> with sodium amalgam (Metallex process, Oak Ridge, 1954 [26]) and reduction with magnesium in the Kroll process, which was favored because of the price of magnesium and its lower sensitivity to oxygen (1956).

Table 42.13: Free-energy change in reduction of thorium compounds to metallic thorium.

Reaction temperature <i>T</i> , K	Oxide		ThF <sub>4</sub>		ThCl <sub>4</sub>	
	1223		2023		1150	
Free energy of formation from elements at <i>T</i> , kJ/mol	ThO <sub>2(s)</sub>	-998.4	ThF <sub>4(l)</sub>	-1545.7	ThCl <sub>4(l)</sub>	-831.8
	2Na <sub>2</sub> O <sub>(s)</sub>	-487.7	4NaF <sub>(l)</sub>	-1303.0	4NaCl <sub>(l)</sub>	-1219.7
	2MgO <sub>(s)</sub>	-934.4	2MgF <sub>2(l)</sub>	-1472.1	2MgCl <sub>2(l)</sub>	-931.9
	2CaO <sub>(s)</sub>	-1015.7	2CaF <sub>2(l)</sub>	-1774.5	2CaCl <sub>2(l)</sub>	-1241.2
Free-energy change in reaction, kJ/mol						
Th reduced with						
4 mol Na		+510.6		+243.4		-357.9
2 mol Mg		+64.0		+73.6		-70.1
2 mol Ca		-17.3		-255.5		-379.4

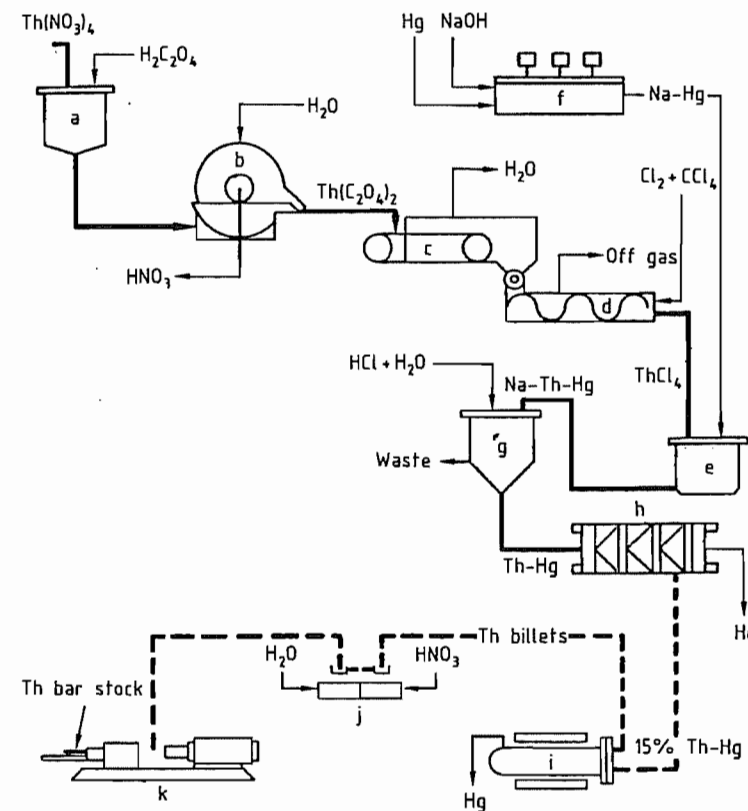

Figure 42.16: Schematic of Metallex process: a) Precipitator; b) Filter; c) Dryer; d) Chlorinator; e) Contractor; f) Electrolyzer; g) Scrubber; h) Hydraulic filter press; i) Retort; j) Pickler and washer; k) Extrusion.

**Metallex Process.** The flow diagram of the Metallex process, which requires relatively simple equipment, is shown in Figure 42.16. Originally, ThCl<sub>4</sub> was dissolved in propylene-diamine and reacted with liquid sodium amalgam. However, this step was then replaced for cost reasons by direct reaction of solid thorium chloride with the amalgam at 180–

300 °C in a kneader mixer, a conversion of 97% being obtained after 30 min. Excess sodium and sodium chloride were removed by washing with dilute HCl, and solid ThHg<sub>3</sub> was removed from excess Hg (in which thorium metal is soluble to < 0.1% at room temperature) by means of a filter press. Thorium amalgam was then decomposed in a steel retort at

1100 °C in vacuum, to remove mercury and produce a sintered solid. Since mercury as a high parasitic neutron capture cross section and can also attack the aluminum cladding on thorium rods in the reactor, it must be rigorously excluded. The process is consequently not without risk.

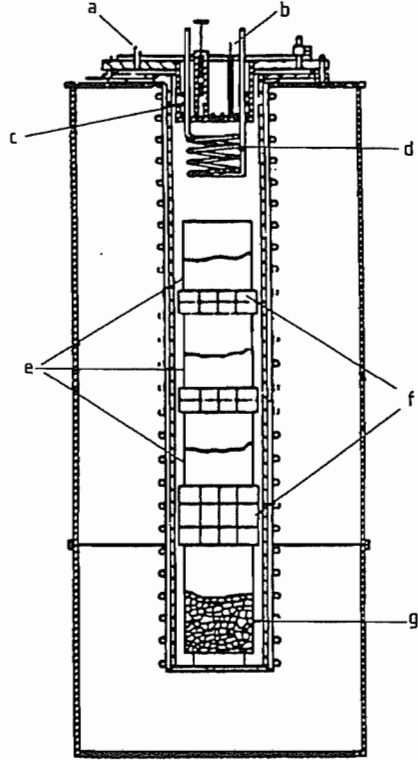

Figure 42.17: Furnace for  $\text{ThCl}_4$  reduction (Kroll furnace): a) Vacuum connection; b) Thermocouple; c) Lift heater; d) Air-cooled condenser; e)  $\text{ThCl}_4$  container; f) Distance disks; g) Melting crucible containing magnesium.

**Kroll Process.** The Kroll process, in which thorium chloride is reduced with magnesium [27], was developed at about the same time by the National Lead Company of Ohio. Although this process was originally expected to have a wide application for the treatment of all air-sensitive transition metals, it has in fact become widely used only for titanium, zirconium, hafnium, and thorium. In further development of the process by Ames Laboratories, thorium chloride is completely reacted

at 850–950 °C in a furnace provided with exterior heating, by using twice the stoichiometric quantity of magnesium to give a Th–Mg alloy (Figure 42.17). This alloy melts and forms a compact regulus. Magnesium chloride and excess magnesium are then distilled off at 950 °C in a high-vacuum furnace (Figure 42.18) and collected in collection vessels.

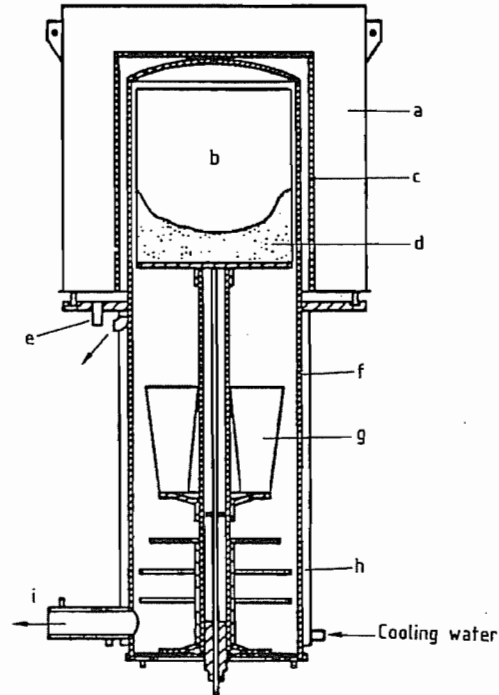

Figure 42.18: High-vacuum distillation furnace: a) Furnace; b) Distillation crucible; c) Heating element; d) Thorium sponge; e) Furnace vacuum connection; f) Inner wall of reactor; g) Collecting vessel; h) Cooling jacket; i) Reactor vacuum connection.

**Reduction of  $\text{ThF}_4$  with Calcium.** Quantitatively, the most important method for producing thorium of nuclear purity in the United States was reduction of  $\text{ThF}_4$  with calcium metal. The process developed by Ames Laboratories and Iowa State University [28] was analogous to the production of uranium metal. However, when calcium metal reacts with  $\text{ThF}_4$ , the heat of reaction is insufficient to melt the thorium metal. Additional heat is therefore generated by reacting  $\text{ZnCl}_2$  with calcium metal. This also produces a lower-

melting thorium–zinc alloy and a lower melting point eutectic of  $\text{CaF}_2$  and  $\text{CaCl}_2$ . The process requires careful preparation of the reactants since most of the metallic impurities in the reactants end up in thorium. Calcium metal must be sieved to remove fine-grained material after preliminary size reduction because this material contains most of the impurities. Zinc chloride must also be of high purity; it must be anhydrous and not too fine grained, otherwise the reaction with calcium can take place prematurely. The reduction furnace is illustrated in Figure 42.19. The furnace pot (e), which is made of nonscaling steel, is placed inside the muffle (g). This is heated by three heating elements (d, f, h), outside which is a lining of calcined dolomite. The reaction mixture consists of 75.3 kg of  $\text{ThF}_4$ , 27.22 kg of granulated calcium metal, and 7.26 kg of anhydrous  $\text{ZnCl}_2$ . A layer of dolomite powder is placed above and below the reactants to protect the walls. The furnace is heated to 660 °C, and when the contents reach 475 °C a strongly exothermic reaction begins, producing a Zn–Th alloy containing 18 mol% Zn. The furnace is operated behind safety walls because deflagrations occasionally occur. After cooling, the slag is removed, and 90% of the zinc can be distilled off in vacuum (< 27 Pa). The thorium sponge is cooled in a protective gas and then inductively melted in a BeO crucible in vacuum. The remaining zinc evaporates, and the thorium is cast in graphite molds (yield 94–86%).

## 42.7 Metalworking [11, pp. 222ff; 29; 30]

Most production processes lead to thorium powder or sponge. This must therefore be compacted by sintering or melting before it can be worked in a metal-forming process. In the literature, densification by powder metallurgy is described in less detail than melting and casting.

**Melting and Casting.** To cast thorium metal, it is first melted at 1800 °C by inductive heat-

ing in vacuum to avoid the danger of picking up  $\text{O}_2$  and  $\text{N}_2$ . Also, zinc left behind from the production process (reduction of  $\text{ThF}_4$  with Ca, see earlier) must be evaporated, and pickup of impurities from the crucible material must be as low as possible. For this, either zinc is removed first in graphite crucibles at a temperature at which thorium hardly picks up any carbon from graphite (1300 °C) and the actual melting is carried out later in BeO crucibles, or both processes are carried out together in a stabilized  $\text{ZrO}_2$  crucible. Thorium metal has a very low heat of fusion and, when fused, attacks all known crucible materials, so that excessive heating must be avoided. Both the service life of the BeO crucible and the limitation of pickup of impurities by thorium are only moderately satisfactory.

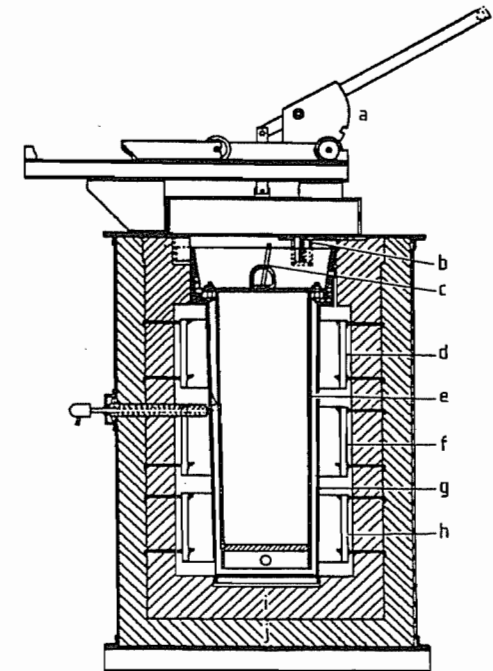

Figure 42.19: Section view of reduction furnace pot: a) Cover lifting mechanism; b) Muffle hanger; c) Pot alignment bar; d) Top element; e) Furnace pot (steel); f) Center element; g) Muffle; h) Bottom element; i) 2600 °C insulation brick; j) 1600 °C insulation brick.

Table 42.14: Average analyses of thorium ingots.

Type of analysis	Impurity	Induction melted; charge; 40% scrap, 60% virgin metal	Arc melted	
			Charge: virgin metal	Charge: virgin and scrap metal
Chemical	ThO <sub>2</sub> , %	2.8	1.34	2.42
	ZrO <sub>2</sub> , %	0.14		
	N, mg/kg	290	142	211
	C, mg/kg	465	211	193
Spectrochemical	Al, mg/kg	370	20	13
	B, mg/kg	3.9	0.4	0.5
	Fe, mg/kg	600	243	441
	Ni, mg/kg	520	324	486
	SiO <sub>2</sub> , mg/kg	500	34	30
	Zn, mg/kg	10	128	43
	U, mg/kg	20	10	6
Hardness, BHN <sup>a</sup> , 500-kg load		64	54	56
Density, g/mL		11.52	11.57	11.64

<sup>a</sup>BHN = Brinell hardness number.

Table 42.15: Effect of carbon content on mechanical properties of iodide-source thorium (cold rolled to 85% reduction and annealed 30 min at 650 °C).

Carbon content, %	Yield strength (0.2% offset), MPa	Tensile strength, MPa	Elongation, %	Reduction of area, %	Hardness, VHN <sup>a</sup>
0.015	52.4	124.1	27.0	60	40
0.022	44.8	121.3	50.0	62	34
0.047	113.1	179.3		43	60
0.070	185.5	237.2	46.0	51	83
0.130	242.0	302.7	41.0	46	109
0.187	346.8	369.6	38.0	39	125
0.22	346.8	418.5	30.0	39	140

<sup>a</sup>VHN = Vickers hardness number.

A two-stage electrode-consuming arc melting process is a better alternative for producing the cylindrical ingots generally used in nuclear technology. The molten thorium metal is subsequently solidified in water-cooled copper crucibles. The pieces of thorium sponge obtained from the first dezincification are sawed into strips in chambers filled with inert gas and then welded together to form electrodes. However, metal is lost in this laborious operation, and attempts have therefore been made to replace it by hot plastic forming of the sponge (casting or compaction). The properties of the ingots obtained by induction and arc melting are listed in Table 42.14.

In subsequent metalworking, thorium resembles soft iron in its ductile behavior. Even the presence of several percent oxygen does not cause problems, because oxygen is virtually insoluble in thorium and therefore only contained in inclusions of ThO<sub>2</sub>. To prevent

surface oxidation—especially of the small pieces used during hot working by, e.g., rolling, hammering, or extruding—the pieces are encased in soft copper or iron cladding, which is later dissolved in acid. Welding of thorium is possible only in an inert-gas atmosphere. Thorium can be soft-annealed after cold working (e.g., rolling) by heating to 500–700 °C. No problems occur due to phase transition since these occur only above 1400 °C. Impurities picked up during the various production processes affect workability. Small amounts of oxygen and beryllium have little effect, but carbon causes hardening. As with steel, considerable precipitation hardening occurs on quenching from the soft-annealed state at 600–800 °C (see Table 42.15). Elements that form carbides (e.g., titanium, niobium, and tantalum) considerably counteract this effect.

The dimensionally accurate tubes—required for fuel elements used in breeder reac-

tors—were usually extruded at 600–700 °C, using a protective coating of copper or soft iron. Both of these metals form reaction zones with thorium that must subsequently be machined off. To prevent this, oxidic coatings on thorium were investigated. Alternatively thorium can also be preheated in a molten salt bath consisting of nitrites and cyanides of alkali metals. The adherent salt film acts as a protective and lubricating film. The method eventually favored was to coextrude thorium with an inner and outer cladding of aluminum. Zirconium of similar plasticity obtained by preheating zirconium ingots was used as cladding at a later stage. Process details are unknown for reasons of military secrecy.

## 42.8 Intermetallic Compounds

Thorium has limited solubility in carbon and nitrogen, and can form compounds of metallic character with both elements. These are described below and in Section 42.5.

### 42.8.1 Thorium and Carbon

Carbon is usually present as an impurity in thorium. Thorium produced by decomposition of thorium iodide contains 0.01–0.05% C, and from halide reduction 0.03–0.12% C. As mentioned in Section 42.7, carbon is one of the few elements that increases hardness and age hardening properties of thorium. Of all the elements that improve steel properties, only chromium can by itself (and even more in combination with carbon) produce comparable effects in thorium. Only indium seems to be more effective but is excluded from nuclear applications due to its neutron absorption. The other metals investigated (Ti, V, Mo) have a minor hardening effect, probably due to the formation of carbides with the carbon in thorium. However, the effect is partially negated by the hardness reduction caused by removal of carbon. The Th–C constitutional diagram (Figure 42.20) shows the two compounds ThC

and ThC<sub>2</sub> (see Section 42.5). The effect of temperature on the solubility of carbon in thorium is given below:

20 °C	0.35%
800 °C	0.43%
1018 °C	0.57%
1215 °C	0.91%

### 42.8.2 Thorium and Nitrogen

The compounds ThN and Th<sub>2</sub>N<sub>3</sub> are described in Section 42.5. The solubility of nitrogen in thorium increases linearly with temperature, being 0.05% at 850 °C and 0.35% at 1500 °C. In thorium formed by halide reduction, nitrogen is usually present only at levels of 0.02%. The strength of thorium–nitrogen alloys increases moderately with increasing nitrogen content. Precipitation hardening (age hardening) of the alloy after annealing at 850 °C occurs only with quenching temperatures of < 300 °C.

## 42.9 Uses

### 42.9.1 Nuclear Technology [31]

**Production of <sup>233</sup>U.** Use of thorium in the nuclear industry is based on its ability to behave as a breeder. It absorbs neutrons and forms <sup>233</sup>U by successive release of two β-particles according to

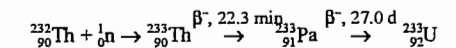

The isotope <sup>233</sup>U is notable for the fact that the ratio of neutrons liberated on fission to those absorbed is more favorable than the corresponding ratio of <sup>235</sup>U and <sup>239</sup>Pu. This has aroused interest in this nuclide—which is complicated to produce—in both the military and the civil areas. The <sup>233</sup>U formed from thorium can either be separated from the breeder material by chemical methods or undergo fission in situ by absorption of further neutrons, thereby releasing energy. Both methods are subject to a number of limitations.

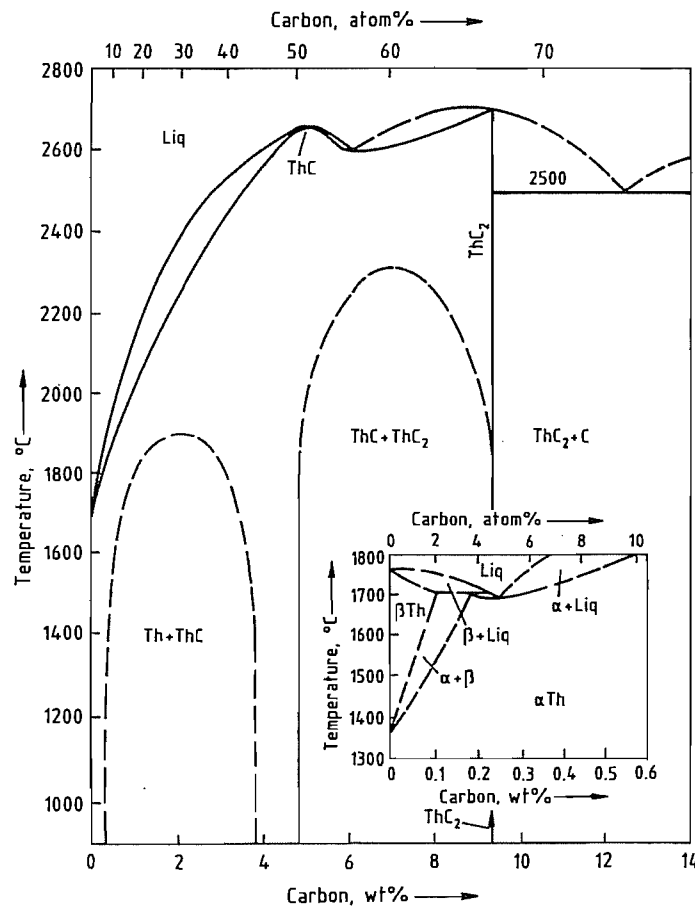

Figure 42.20: Phase diagram of the thorium-carbon system.

**Chemical Separation of  $^{233}\text{U}$ .** In separating  $^{233}\text{U}$ , it must be kept in mind that  $^{232}\text{U}$  can be formed in an  $n,2n$  reaction with neutrons with an energy of  $> 6.27$  MeV from the  $^{233}\text{U}$  already formed, and mainly from  $^{232}\text{Th}$  via  $^{231}\text{Th}$  and  $^{231}\text{Pa}$  by further neutron capture. To avoid this reaction, thorium must be allowed to interact only with low-energy thermal neutrons. The same isotope  $^{232}\text{U}$  is also formed with a cross section 14 times as large by low-energy neutron capture by  $^{230}\text{Th}$ . Although  $^{230}\text{Th}$  is present in thorium at a level of only a few parts per million, its concentration can be higher if thorium is a by-product of uranium production, in which case  $^{230}\text{Th}$  is present as an  $\alpha$ -decay daughter of  $^{234}\text{U}$ .

Whereas  $^{232}\text{U}$  is not itself harmful, a serious handling problem arises from the fact that it decays relatively rapidly to its daughter product  $^{208}\text{Tl}$ , which emits penetrating  $\gamma$ -radiation with an energy of 2.62 MeV.

In practice, this means that thorium must not be used in a thermal neutron flux in molecular proximity to neutron sources (e.g., as a U-Th alloy, mixed oxide, or mixed carbide)—which would give optimum neutron capture—but should be kept separate from the neutron source  $^{235}\text{U}$  (or  $^{239}\text{Pu}$ ) in breeder rods covered with a layer of moderator.

To give an idea of quantities, if 1 t of thorium is irradiated for some weeks in the carefully thermalized neutron flux and then cooled

for 150 d to enable the fission product iodine, which interferes with the separation process, to decay, this forms ca. 1 kg  $^{233}\text{U}$  containing ca. 8 mg/kg  $^{232}\text{U}$ . This then remains in a handleable state for some weeks without complicated gamma shielding. The overall complexity of this operation can be reduced by replacing the thorium metal rods with ceramic  $\text{ThO}_2$  tablets, which are easier to produce but more difficult to dissolve later since  $\text{HF} + \text{HNO}_3$  must be used. Even under these conditions, with a handling concentration limit of 10–20 mg/kg  $^{232}\text{U}$ , an optimistic price estimate for  $^{233}\text{U}$  is still twice that of highly enriched uranium [32]. According to published data, no more than 3 t  $^{233}\text{U}$  has been produced worldwide, of which  $\leq 800$  kg in the United States. New fuel rods have been produced from this in only one full-scale experiment (Kilorod Facility, Oak Ridge, Tennessee [33]).

Attempts to irradiate thorium in the form of a fluid medium or of  $\text{ThF}_4$  dissolved in fused salts [34] were finally not successful.

**"In Situ" Fission.** In an alternative method,  $^{233}\text{U}$  is caused to undergo fission with generation of heat at the place where it is formed. Here, fewer possibilities exist for controlling the nuclear reaction, and thorium is by no means completely consumed, but the system is technically easier to realize. Also, a particular property of thorium can be utilized—i.e., its ability to form a series of solid solutions with other actinide oxides ( $\text{UO}_2$ ,  $\text{PuO}_2$ )—thereby stabilizing them at high temperature. This is mainly a property of  $\text{ThO}_2$ , to a lesser extent of the carbide, and to a small extent of the metal. Also, since the formation of  $^{232}\text{U}$  does not present a problem, the higher neutron flux (by at least an order of magnitude) of the fast breeder reactor is advantageous.

Thorium oxide forms a series of mixed crystals with a cubic fluorite structure with both  $\text{UO}_2$  and  $\text{PuO}_2$ , so that fuel elements can be produced in which thorium is the main component and which are stable when heated in air to  $> 1200$  °C. This facilitates both production and safety analysis. The mixed crystals show no phase transformation up to their

melting point of  $> 2600$  °C. However, used fuel elements of this type can be dissolved only in mixtures of  $\text{HNO}_3$  and  $\text{HF}$ , which attack most available containment materials. Except in India where much thorium but comparatively little uranium is available, all fast breeder programs currently in operation are based on the uranium-plutonium cycle, and no thorium is used.

Thorium could be used in thermal reactors to extend the use of  $^{239}\text{Pu}$ , which is produced as a fuel by transformation of  $^{238}\text{U}$ . However, continuous hydrogenation of the cladding material (Zircaloy) limits the burnup in water reactors to ca. 50 000 MW·d/t, so that there is little advantage in using thorium, which is therefore limited to *graphite-moderated thorium-high-temperature reactors* (THTRs), which allow ten times the burnup. Here, the fuel elements consist of small particles of uranium and thorium oxide or uranium and thorium carbide, embedded in a graphite matrix [35].

Owing to parasitic neutron capture in the thorium cycle, Th-U fuel required highly enriched uranium (93%  $^{235}\text{U}$ ), and the possible consequent proliferation of weapons-grade material led to concern on the part of source countries (United States). Therefore, new fuel variations are no longer based on thorium. Slightly enriched uranium (10%  $^{235}\text{U}$ ), which is not suitable for weapons, is used instead.

So far, high-temperature reactors have not reached the threshold of economic viability achieved by other methods of generating electricity. The safety advantage has not compensated for this disadvantage, and no power stations of this type are currently under construction or being operated.

Because of the wide variations in targeted burnups and the question of whether—and to what extent—thorium is recycled to the reactor, figures for thorium consumption fluctuate not only with reactor capacity but also according to the mode of operation. In using the minimum consumption figures that correspond to maximum recycling, the THTR reactor requires 7.3 t/a thorium for each 1000-MWe capacity, 340 kg  $^{233}\text{U}$  can be recovered from the

used fuel elements, and 6.8 t Th (containing isotopes that interfere with a second burnup) must be disposed of as nuclear waste. The initial inventory of the reactor is ca. 60 t of thorium.

## 42.9.2 Conventional Applications

### 42.9.2.1 Illuminants

The most important application of thorium followed the discovery by AUER VON WELSBACH in 1892 that some rare earth oxides and thorium oxide, when introduced in the form of woven yarn into a gas flame, considerably increased the luminous efficacy of the flame. This emission of light is excited by cathode rays, heat, and UV radiation. Although pure cerium oxide converts the UV fraction of an oxidizing gas flame into visible light more efficiently than  $\text{ThO}_2$ , it is not used in practice because so much light is emitted in the IR region that "cooling" of the gas flame occurs. Excitation of cerium oxide gives a gas flame temperature of only 1500 °C, whereas thorium oxide gives 1930 °C. Maximum luminous efficacy occurs with 1% cerium oxide in  $\text{ThO}_2$  [36].

The requirements of maximum light-emitting surface area together with stability in a gas flame in which high flow rates occur at the zone of maximum temperature led to the development of the gas mantle, whose shape matches that of the combustion zone of the flame. Today, commercially available gas mantles are produced by soaking artificial silk (viscose or cellulose ester fibers) in a solution of thorium and cerium nitrates. The hydroxides are then formed by treatment with alkali and fixed to the fiber; the organic carrier material is burned off, and the remaining ash structure is fixed with collodion lacquer.

Modern gas mantles give a luminous efficacy of 3 lm/W with propane, which is even better than that produced by electric incandescent lamps. Gas mantles are expressly excluded from the restrictions on radioactive substances, although the inhalation of ash from used gas mantles, which can easily occur

on careless handling, can lead to harmful deposits in the lungs.

Thorium oxide also had limited application as a light converter (UV into visible light) in fluorescent lamps before modern oxide mixtures were developed.

### 42.9.2.2 Electron Emitters

In the production of incandescent filaments, the rate of recrystallization of tungsten is considerably reduced by adding 1%  $\text{ThO}_2$  to the tungsten sintering powder before drawing the filaments.

A side effect of this addition was noticed: i.e., that a small addition of thorium oxide to the tungsten used in heated electrodes considerably reduces the work function of electrons (see Figure 42.4) [37]. This is probably due to the formation of a ThO dipole layer, which is constantly renewed from the interior of the electrode. Therefore, since 1922, thoriated tungsten wires have been used in electronic tubes and in the cathodes and anticathodes of X-ray tubes and rectifiers. Owing to the reactivity of thorium with  $\text{O}_2$  and  $\text{N}_2$ , it also acts as a getter for impurities in the evacuated tubes.

These applications decreased very much following the introduction of transistors in the 1950s, but reduction of the electron work function is still a useful phenomenon, having a beneficial effect on the process of welding in an inert gas (argon, helium), for which thoriated tungsten electrodes are used.

### 42.9.2.3 Ceramics and Glass

Thorium oxide crucibles represent the most refractory material known and can be used for melting pure, carbon-sensitive metals at 2300 °C. The crucibles are produced by sintering fused and ground thorium oxide—small additions of  $\text{ZrO}_2$ ,  $\text{P}_2\text{O}_5$ , and cryolite being used as sintering aids. Although its application is very limited,  $\text{ThO}_2$  is also used to increase the density of  $\text{ZrO}_2$  crucibles.

Like  $\text{ZrO}_2$ ,  $\text{ThO}_2$  increases the hardness of dispersion-hardened alloys, e.g., in an Ni-16Cr-(3–5)Al alloy for gas turbine blades.

The addition of  $\text{ThO}_2$  to glass leads to extremely high refractive indices with low dispersions and densities lower than those of lead glass. However, this application is also limited because rare-earth oxides have a similar effect and are not  $\alpha$ -emitters.

### 42.9.2.4 Catalysts [38]

The catalytic effect of  $\text{ThO}_2$  seems to be due to an increase in the mobility of hydroxyl ions and hydrogen. Thus, a large number of hydroxylations, hydrogen additions, hydrogen eliminations, oxidations, and reductions have been documented in which thorium catalysts are used. The earliest use of thorium as a reactant and catalyst at the same time was the reaction of aliphatic dicarboxylic acids to give ring ketones (civetone, synthetic musk) by dry distillation of thorium salts [39].

Thorium oxide was used as a fixed-bed catalyst with nickel and cobalt on a kieselguhr carrier, first in ammonia synthesis and then in oil refining and the Fischer-Tropsch process. It was also employed in dehydrogenation, isomerization, and a number of other reactions.

An alloy of platinum with 10% thorium is a very good catalyst for the oxidation of ammonia to nitrogen oxides. However, a 5% rhodium alloy with platinum is now preferred because of its superior mechanical properties and longer lifetime in the form of a gauze.

In almost all cases,  $\text{ThO}_2$  has been replaced by cheaper catalysts (e.g., based on rare earths) and is now hardly used.

### 42.9.2.5 Medicine

Thorium dioxide was used as a contrast medium (Thorotrast) when making X-ray photographs of hollow organs but has been replaced by nonirradiating substances.

$^{225}\text{Ra}$  has been used experimentally for therapeutic irradiation, as this is the only isotope of radium that does not have a gaseous decay product. It is obtained either as a short-lived daughter nuclide of  $^{229}\text{Th}$ , which is the most stable daughter nuclide (half-life 7340 a)

in the  $^{233}\text{U}$  decay chain, or can be produced by neutron irradiation of  $^{226}\text{Ra}$ .

## 42.9.2.6 The Demand for Thorium

In the first phase of utilization from 1893 to 1940, mostly for the production of gas mantles, worldwide consumption was ca. 8000 t  $\text{ThO}_2$ , of which 3300 t came from India, 4000 t from Brazil, 370 t from the United States, 100 t from Indonesia, 60 t from Sri Lanka, and the rest from Norway, Australia, and a few other countries, together with a small amount of recycled material.

India, which produced 280 figures since development of the nuclear application. Nonnuclear use has in general decreased since 1950 [40].

In Germany in the 1990s, thorium consumption decreased to ca. 1.5 t/a, having been 3–5 t/a a few years before. Four companies produce thoriated tungsten electrodes, and one company produces electric discharge lamps. Gas mantles are mainly imported from France. Large quantities of thorium oxide, a coupled product from rare earth production, are stored in various parts of the former German Democratic Republic. This material will probably not be utilized but will be deposited as radioactive waste in a waste disposal site.

## 42.10 Product Quality and Analytical Methods

**Product Quality.** Thorium is commonly marketed in the form of solid thorium nitrate. Here, the thorium content and the level of certain impurities are important. Rare earths, magnesium, calcium, and heavy metals that can be precipitated by sulfide (mainly Fe) are determined.

Thorium nitrate used in the production of gas mantles is highly purified by multiple recrystallization or oxalate precipitation. Rare earths (except in concentrations < 1%) are undesirable because they stimulate the emission of IR radiation, thereby reducing the emission of visible light. Very small proportions

(> 0.02%) of SiO<sub>2</sub> lead to embrittlement of the gas mantle [41].

Sulfate in ThO<sub>2</sub> has a detrimental effect on crucible production and is removed by multiple dissolutions and precipitations of thorium as oxalate.

The rare earths are also undesirable in nuclear technology because some of them (e.g., erbium and gadolinium) are strong neutron absorbers. Therefore, these elements must be removed. If thorium is used in metallic form, the oxygen and carbon contents are important, the latter from the point of view of hardness properties. When processing irradiated thorium, uranium and thorium must be separated.

The determination of low concentrations of thorium is important in the quality control of alloys. Very low concentrations must be determined in geochemistry and environmental analysis, and when removing <sup>230</sup>Th from uranium compounds.

**Analytical methods** are based on the selective separation of thorium. The natural accompanying elements and compounds in thorium include La and lanthanides, Y, Sc, Ti, Zr, Hf, U, Fe, Al, Ca, SiO<sub>2</sub>, and P<sub>2</sub>O<sub>5</sub>. Only a few reactions exist that are specific for thorium; moreover, it has a stable valence of four so redox separations are impossible. The most difficult precipitation separation is that of scandium, although large amounts of this element are seldom associated with thorium.

**Precipitation processes** usually start with solutions in relatively strong mineral acids. Precipitation of thorium as the oxalate, fluoride, peroxide, iodate, and hypophosphate gives the best selectivity, the last of these even against rare earths. Some organic dicarboxylic acids, especially tetrachlorophthalic acid, are more selective than oxalic acid. Dimethyl oxalate, which slowly hydrolyzes in warm solutions of mineral acids, can also be used to give slow formation of a precipitate that is free of inclusions.

Most of the compounds soluble in organic solvents that are used for *liquid-liquid extractions* in nuclear technology have been tested for the selective separation of thorium, mainly

from solutions in nitric acid, for analytical purposes. They include 1-(2-thenoyl-3,3,3-trifluoroacetone (TTA), mesityl oxide, dibutoxytetraethylene glycol ("penta ether"), long-chain amines (trilaurylamine), TBP [42], and a series of organic phosphonium compounds, especially bis(dialkylphosphinyl)methane [43]. The latter extractants, in particular, separate uranium and thorium selectively from the rare earths. Uranium is most effectively separated from thorium by means of the appropriate choice of ligands (branched or straight-chain) and of the concentrations of the acid and salt in aqueous stripping. Bis(dialkylphosphinyl)methanes are more selective extractants than trialkylphosphine oxides. The branched-chain, sterically hindered phosphine oxides extract U(VI) more effectively, whereas the straight-chain compounds extract thorium more effectively.

Good selectivity against the rare earths and selectivity against uranium can also be obtained by extracting thorium with TBP from nitric acid solution if the TBP concentration is 40% in the organic solution (instead of 10% as used with uranium). In contrast to uranium, stripping is best carried out by salting out with nitrates in the presence of moderately concentrated HNO<sub>3</sub>.

Few selective *analytical reagents* for thorium in solution are known. Their selectivity is generally considered to depend on the bond formed with inner electrons of thorium, as in the case of precipitation with dicarboxylic acids. The compounds formed are generally more sparingly soluble than the corresponding rare earth compounds.

Reagents include a series of weak organic acids with acid groups on adjacent carbon atoms, and other compounds that can form chelate-like complexes. The pink coloration produced by the reaction of ammoniacal solutions of pyrogallol with Th<sup>4+</sup> has been known for some time, although this is only moderately stable and selective. The formation of star-shaped groups of red needles with Orange II (*p*-(2-hydroxy-1-naphthyl)azo]benzenesulfonic acid), is used for microchemical detection. The most selective reaction known is

the formation of a red coloration with thorin, 4-(2-arsonophenylazo)-3-hydroxy-2,7-naphthalenedisulfonic acid (in the absence of oxalate and fluoride). This coloration is measured at 54.5 nm in sulfuric acid solution, although a number of other compounds that react in a similar way (dibenzoylmethane, aurintricarboxylic acid, alizarin S) also give color reactions or form color lakes.

When impurities originating from production and processing of thorium metal and its compounds are to be analyzed most of the thorium must be separated first. The impurities can then be determined by the usual methods. This applies also to spectrographic analysis, for which most of the thorium should first be removed because of its complex line spectrum.

## 42.11 Toxicology

Thorium, its natural decay products, and its compounds are toxic both as heavy metals and as radioactive substances. However, their heavy-metal toxicity is low because of their low solubility in body fluids and organs, and has been compared with that of aluminum.

## 42.12 Industrial Safety

In addition to toxicological risks, the spontaneous flammability of thorium metal constitutes a handling hazard.

Thorium has been extracted and processed on an industrial scale since 1893, mostly as the oxide. However, the incidence of harmful effects associated with the handling of thorium is very low. In the absence of strong complex formers (e.g., citrates), water-soluble thorium compounds are immobilized close to the point of incorporation into the body in the form of insoluble hydroxides. Animal experiments first gave an LD<sub>50</sub> of 1–2 g/kg. The low water solubility also prolongs the excretion process, mainly via the feces, and to a lesser extent the kidneys. Exposure to thorium occurs mainly by inhalation of dust into the tracheobronchial tract and the lungs. No toxic chemical effect

has thus far been observed in these areas, but radiation damage can occur in the lungs and from the small amounts of thorium transported to the bones.

Thorium is often compared with uranium, which has been well investigated radiologically. Thorium differs from uranium in the more rapid buildup of its daughter nuclides, which also have chemically different properties (Figure 42.1). Important daughter nuclides are <sup>228</sup>Ra, <sup>228</sup>Ac, <sup>228</sup>Th, <sup>224</sup>Ra, and <sup>220</sup>Rn. Other decay products are of little radiological importance. As shown in Figure 42.2, freshly separated thorium passes through two activity maxima, one after ca. 5 weeks and a second after ca. 60 a, with an intermediate activity decrease after 3 a. In addition to the relatively low β- and γ-radiation, α-radiation has a significant effect on the living organism due to the high ionization density that it produces. During chemical isolation of thorium from ores or residues that have been stored for a long time, <sup>228</sup>Ra and <sup>224</sup>Ra become concentrated in the filtrate (to > 70% in oxalate precipitation). These nuclides are precipitated with sulfate to concentrate them in sediment and prevent them from passing into receiving waters. Furthermore, phase transformations and chemical changes of thorium and its compounds cause the release of all the <sup>220</sup>Rn formed in the solid up to that point, which can lead to the buildup of significant α-activity in poorly ventilated areas. Table 42.16 gives the maximum permissible concentrations of thorium and its decay products according to the USAEC Regulations of 1955 (still in curies). The German legal requirements for thorium according to the Strahlenschutzverordnung are listed in Table 42.17. The recommended annual limits for incorporation (ALI) in the International Commission on Radiological Protection (ICRP) 30 Regulations are based on a metabolic inhalation model. This has been used to test the relationship between the uptake of thorium and biological detection in a large group of workers in a monazite processing plant [44]. It showed that the analysis of urine and feces correlated only moderately well with the short-term uptake of thorium.

After inhalation of insoluble thorium compounds urine analyses showed a maximum thorium uptake fraction of  $1.4 \times 10^{-3}$ , up to 12% were found in feces, both at the second day after incorporation. Almost all measurements yielded higher figures than the ICRP recommendation, although there was no detectable damage to health. Cytogenetic studies in parallel with this showed no correlation between the frequency of chromosomal aberrations and the duration of contact. Clearance from the lungs has a biological half-life of > 500 d, and from bones ca. 200 a.

The workplace should therefore be kept as dust free as possible.

### 42.13 Environmental Protection

Thorium occurs almost ubiquitously in nature in low concentrations. Because of its poor

solubility in water, it occurs in extremely low concentrations in the biological cycle, and because its use in industry is not increasing, special environmental protection measures are unnecessary. Only in a few locations where thorium was used or processed in the past are soil remediation operations occasionally required.

**Table 42.16:** Maximum permissible concentrations of thorium and the daughter products radium-228 and radium-224.

Element	Body limit, $\mu\text{C}$	Water MPC <sup>a</sup> , $\mu\text{C}/\text{cm}^3$	Air MPC <sup>a</sup> , $\mu\text{C}/\text{cm}^3$
<sup>232</sup> Th (soluble)	0.01	$5 \times 10^{-7}$	$3 \times 10^{-13}$
<sup>232</sup> Th (insoluble)	0.002 <sup>b</sup>		$3 \times 10^{-13}$
<sup>228</sup> Ra (soluble)	0.04	$8 \times 10^{-8}$	$1 \times 10^{-11}$
<sup>228</sup> Ra (insoluble)	0.002 <sup>b</sup>		$2 \times 10^{-12}$
<sup>224</sup> Ra (soluble)	0.06	$5 \times 10^{-5}$	$8 \times 10^{-9}$
<sup>224</sup> Ra (insoluble)	0.003 <sup>b</sup>		$3 \times 10^{-10}$

<sup>a</sup>MPC = maximum permissible concentration.

<sup>b</sup>Lung only.

**Table 42.17:** Exposure and annual limits for inhalation and digestion of radon, radium, actinium, and thorium.

Atomic no.	Element	Radionuclide	Exposure limit, Bq	Annual limit	
				Inhalation, Bq	Ingestion, Bq
86	radon	<sup>220</sup> Rn	$5 \times 10^6$	$3 \times 10^8$	
		<sup>220</sup> Rn <sup>a</sup>		$5 \times 10^5$	
		<sup>222</sup> Rn		$2 \times 10^8$	
		<sup>222</sup> Rn <sup>a</sup>		$4 \times 10^6$	
88	radium	<sup>223</sup> Ra	$5 \times 10^3$	$9 \times 10^3$	$1 \times 10^5$
		<sup>224</sup> Ra		$2 \times 10^4$	$2 \times 10^5$
		<sup>226</sup> Ra		$9 \times 10^3$	$4 \times 10^4$
		<sup>228</sup> Ra		$2 \times 10^4$	$5 \times 10^4$
				$9^b$	$4 \times 10^3$
89	actinium	<sup>227</sup> Ac	$5 \times 10^3$	$40^c$	
				$100^a$	
		<sup>228</sup> Ac		$2 \times 10^5$ <sup>a,b</sup>	$6 \times 10^7$
90	thorium	<sup>227</sup> Th	$5 \times 10^3$	$4 \times 10^3$	$2 \times 10^6$
				$6 \times 10^3$	
		<sup>228</sup> Th		200	$1 \times 10^5$
		<sup>230</sup> Th		100	$9 \times 10^4$
				400	
		<sup>232</sup> Th		30	$2 \times 10^4$
		<sup>234</sup> Th		$2 \times 10^6$	$3 \times 10^6$
				$3 \times 10^6$	
		Th-nat		50	$3 \times 10^4$
				100	

<sup>a</sup>In equilibrium with decay products.

<sup>b</sup>All, except nitrates.

<sup>c</sup>Nitrates.

### 42.14 Legal Aspects

According to German atomic law (AtG), thorium that has not been irradiated is a "miscellaneous radioactive material" but is not a "nuclear fuel" so that according to § 3/§ 9 AtG it must be safely disposed of as a radioactive material. According to the nuclear nonproliferation treaty, thorium is classed as a controlled substance. Quantities of 20 t (source material) must be checked at least once per year, as also prescribed for Europe by Euratom Regulation no. 3227/76. Persons constructing and operating plants for the production, separation, utilization, and storage of thorium must report kilogram or higher quantities of thorium.

Exceptions to this duty to report include gas mantles, to which the limits imposed by the radiation protection regulations do not apply, although the amount of freshly purified thorium in a gas mantle represents the maximum permitted intake of activity for 100 person-years. Aged thorium contained in gas mantles could represent ten times this amount.

### 42.15 References

- G. T. Seaborg: *The Transuranium Elements*, Yale University Press, Washington 1958, p. 113.
- J. R. Naegle: "Surface Analysis of Actinide Materials," in U. Benedikt (ed.): *Transuranium Elements Today and Tomorrow*, North Holland Publ., Amsterdam 1989, p. 66.
- W. Seelmann-Eggebert, G. Pfennig, H. Münzel, H. Klewe-Nebenius: *Nuklidkarte*, Kernforschungszentrum, Karlsruhe 1981.
- S. Tilson: "The Earth's Crust," *Int. Sci. Technol. X* (1962) p. 24, Fig. 3.
- H. Remy: *Lehrbuch der Anorganischen Chemie II*, Akad. Verlagsgesellschaft, Leipzig 1942, p. 544.
- D. F. Peppard et al., *J. Am. Chem. Soc.* 73 (1951), 2529.
- G. Kirsch, *Ber. Wien. Akad.* 131, IIa (1922) 551-568.
- G. T. Seaborg, *Chem. Eng. News* 26 (1948) 1902-1906.
- H. J. Vink, *Chem. Weekbl.* 44 (1948) 685-688.
- H. A. Wilhelm: *The Metal Thorium*, Am. Soc. for Metals, Cleveland, OH, 1956.
- J. R. Murray: "The Preparation, Properties and Alloying Behavior of Thorium," Report AERE-M/TN-12, 1952.
- R. K. Garg et al.: "Status of Thorium Technology," in: *Nuclear Power and its Fuel Cycle*, vol. 2, International Atomic Energy Agency, Vienna 1977, p. 457.
- F. L. Cuthbert: *Thorium Production Technology*, Addison-Wesley-Publ. Comp., Reading, MA, 1958, pp. 62ff.
- P. Krumholz, F. Gottdenker: "The Extraction of Thorium from Monazite," *Proc. Int. Conf. At. Energy* 8 (1956) 126-133.
- F. Soddy, GB 572411, 1949; *Chem. Abstr.* 42 (1948) 731.
- J. Barghusen, Jr., M. Smutz: "The Ames Process," *Ind. Eng. Chem.* 50 (1958) 1754.
- M. Steinhauser: "Löslichkeit von PuO<sub>2</sub> und ThO<sub>2</sub> in HNO<sub>3</sub>," Ph.D. Thesis, Universität München 1987.
- D. J. Crause, K. B. Brown: "Recovery of Th, U, and SE from Monazite Sulfate Leach Liquors by the Amine Extraction (= Ames) Process," *Rep. Oak Ridge National Lab.*, no. 2720, July 16, 1959.
- R. A. Ewing et al.: "Purification of Thorium Nitrate by Solvent Extraction with TBP," *Fin. Rep. USAEC-BMI 946* (1952) pp. 3 ff.
- F. Sachs: "Preparation of ThO<sub>2</sub>," *Nucl. Sci. Abstr.* 6 (1952) 647ff.
- L. Gordon, C. H. Vanselow: "Precipitation of Th from Homogeneous Solution," *Anal. Chem.* 21 (1949) 1323-1325.
- IAEA: "Thorium, Physicochemical Properties of its Compounds and Alloys," *At. Energy Rev. Spec. Iss.* Vienna (1975) Nov. 5.
- V. D. Allred, S. R. Buxton, J. P. McBride, *J. Phys. Chem.* 61 (1957) 117.
- N. D. Veigel et al.: "The Preparation of High Purity Thorium by the Iodide Process," *USAEC-Rep. AEC-3586*, BMI 1953.
- R. J. Meyer, A. Gumperts: "Reinheitskriterien von Thoriumnitrat," *Ber. Dtsch. Chem. Ges.* 38 (1905) 817-825.
- R. E. Blanco: "Status of the Metallex Process," *USAEC-Rep. CF-55-1-53*, ORNL 1955.
- T. C. Runion et al.: "Production of Thorium by Kroll Technique," *USAEC-Rep. NLCO-616*, National Lead Comp. of Ohio, 1956.
- F. H. Spedding: "Progress-Report in Metallurgy," *USAEC-Rep. ISC-6*, Iowa State College, 1947.
- H. A. Wilhelm: *The Metal Thorium*, Am. Soc. for Metals, Cleveland, OH, 1956.
- H. A. Wilhelm, B. A. Rogers: "The Physical Metallurgy of Thorium," *AIIME-IMD Spec. Rep. Ser.* 1955, Oct. 17, 40.
- M. Benedict, T. Pigford, H. W. Levi: *Nuclear Chemical Engineering*, McGraw-Hill, New York 1981, pp. 283-317.
- E. D. Arnold: "Radiation Limitations on Recycle of Power Reactor Fuels," *Proc. 2nd Int. Thorium Fuel Cycle Symp.*, Gatlinburg, TN, May 3-6, 1966.
- R. E. Brooksbank, J. P. Nichols, A. L. Lotts: "The Impact of Kilorod Facility Operational Experience on the Design of Fabrication Plants for <sup>233</sup>U-Th-Fuels," *Proc. 2nd Int. Thorium Fuel Cycle Symp.*, Gatlinburg, TN, Feb. 1968, pp. 321-339.
- W. R. Grimes, D. R. Cuneo: "Molten Salt Reactor Fuels," chap. 17, in C. R. Tipton Jr. (ed.): *Reactor Handbook*, 2nd ed., Interscience Publ., New York 1960.



35. E. R. Merz, G. Kaiser, E. Zimmer: "Progress in Th-<sup>233</sup>U-Recycle Technology," *Am. Nucl. Soc. Topical Meeting*, Gatlinburg, TN, May 1974.
36. F. Möglich, *Angew. Chem.* 53 (1940) 405-409.
37. I. Langmuir, *J. Am. Chem. Soc.* 38 (1916) 2221-2295.
38. R. Bastasz, C. Colmenares: *Catalytic Uses of Thorium and Uranium*, UCID 17499, Lawrence Livermore Laboratories, Livermore, June 1977.
39. L. Rusicka in P. Karrer (ed.): *Lehrbuch der Organischen Chemie*, Thieme Verlag, Stuttgart 1948, p. 789.
40. J. E. Crawford: "Thorium, Minerals, Facts and Problems," *Bull. U.S.-Bur. Mines* 556 (1956) pp. 1ff.
41. H. V. Hodgson, *J.-Soc. Chem. Ind Trans.* 41 (1922) 284.
42. K. Pan, Y. Mao Chen, S. Ti Lee: "A Study of Extraction of Thoriumnitrate with TBP", *J. Chin. Chem. Soc. Taiwan* 7 (1960) pp. 36ff.
43. J. R. Parker, C. V. Banks: "Some Bis(Dialkyl-Phosphinyl)Methanes as Solvent Extractants", Contract W-7405-eng-82, Ames-Lab., Iowa, June 1964, OTS.
44. J. L. Lipstein et al.: "Bioassay Monitoring Studies for Thorium," *Radiat. Prot. Dosim. Ser.* 26 (1989) nos. 1-4, 57-60.

## 43 Plutonium

LOTHAR KOCH

43.1 Introduction .....	1685	43.3 Production .....	1688
43.2 Properties .....	1687	43.4 Compounds .....	1689
43.2.1 Physical Properties .....	1687	43.5 Toxicology .....	1691
43.2.2 Chemical Properties .....	1687	43.6 References .....	1692

### 43.1 Introduction

The first isotope of plutonium (Pu) to be discovered was <sup>238</sup>Pu, which was generated by SEABORG, McMILLAN, KENNEDY, and WAHL in 1940 by bombarding uranium with deuterons:

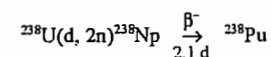

The natural occurrence of plutonium was discovered later. In 1942, SEABORG, PEPPARD, GARNIER, and BONNIER isolated Pu from Canadian pitchblende and Colorado carnotite, in which traces of plutonium (U:Pu = 1:10<sup>-12</sup>) are formed continuously by neutron capture. Primordial <sup>244</sup>Pu was isolated by HOFFMANN et al. from Precambrian bastnasite in 1971. In 1991, COWAN and ECONOMON discovered the double-beta decay of <sup>238</sup>U to give <sup>238</sup>Pu.

Larger quantities (ca. 10 t) of anthropogenic plutonium are distributed on earth as a

result of military activities (bomb tests, satellite accidents, bombers, rockets, etc.) and releases from nuclear facilities. Thus far, ca. 400 t of plutonium has been produced in nuclear power stations outside centrally planned economies (i.e., excluding the former Eastern-bloc countries). The <sup>239</sup>Pu stockpiled in weapons is estimated to exceed 100 t.

Fifteen isotopes of plutonium have been synthesized; long-lived isotopes are listed in Table 43.1. They can be produced by multiple neutron capture by <sup>238</sup>U and hence occur in spent nuclear fuel with varying abundances. Both <sup>239</sup>Pu and <sup>241</sup>Pu are readily fissile with thermal neutrons, for which the absorption cross sections are higher by about two orders of magnitude. Consequently they have lower critical masses in aqueous solution since water moderates the velocity of neutrons. For <sup>239</sup>Pu the critical mass given for metal spheres refers to H<sub>2</sub>O reflectors only (Table 43.1).

Table 43.1: Nuclear properties of long-lived plutonium isotopes.

Mass number	Half-life, a	Decay <sup>a</sup>	Main α-radiation, MeV	Thermal cross section, barn		Critical mass, kg
				Capture	Fission	
238	87.7	α	5.499 (70.9%)	500	17	7.8 (metal sphere reflected by 10 cm iron)
	4.80 × 10 <sup>10</sup>	s.f.	5.457 (29.0%)			
239	2.41 × 10 <sup>4</sup>	α	5.155 (73.3%)	271	742	0.531 (in aqueous solution, fully H <sub>2</sub> O reflected)
	5.50 × 10 <sup>15</sup>	s.f.	5.143 (15.1%)			
240	6.56 × 10 <sup>3</sup>	α	5.168 (72.8%)	290	< 0.08	
	1.34 × 10 <sup>11</sup>	s.f.	5.123 (27.1%)			
241	14.4	β > 99%	4.896 (83.2%)	370	1011	0.260 (in aqueous solution, fully H <sub>2</sub> O reflected)
		α = 2.41 × 10 <sup>-3</sup> %	4.853 (21.1%)			
242	3.76 × 10 <sup>5</sup>	α	4.901 (74%)	19	0.2	
	6.80 × 10 <sup>10</sup>	s.f.	4.857 (16%)			
244	8.26 × 10 <sup>7</sup>	α	4.589 (81%)	1.7		
	6.60 × 10 <sup>10</sup>	s.f.	4.546 (19%)			

<sup>a</sup> α = α-decay; β = β-decay; s.f. = spontaneous fission.

Table 43.2: Structural data for plutonium (see also Figure 43.1).

Phase	Symmetry	Unit cell dimensions, pm	X-ray density, g/cm <sup>3</sup>	Transformation temperature at STP, °C
α	simple monoclinic	at ca. 21 °C a = 618.3 ± 0.1 b = 482.2 ± 0.1 c = 1096.3 ± 0.1 β = 101.79 ± 0.01°	19.86	
β	body-centered monoclinic	at ca. 190 °C a = 928.4 ± 0.3 b = 1046.3 ± 0.4 c = 785.9 ± 0.3 β = 93.13 ± 0.03°	17.70	122 ± 4
γ	face-centered orthorhombic	at ca. 235 °C a = 315.9 ± 0.1 b = 576.8 ± 0.1 c = 1016.2 ± 0.2	17.14	207 ± 5
δ	face-centered cubic	at ca. 320 °C a = 463.71 ± 0.04	15.92	315 ± 3
δ'	body-centered tetragonal	at ca. 465 °C a = 334 ± 1 c = 444 ± 4	16.00	457 ± 2
ε	body-centered cubic	at ca. 490 °C a = 363.61 ± 0.04	16.51	479 ± 4

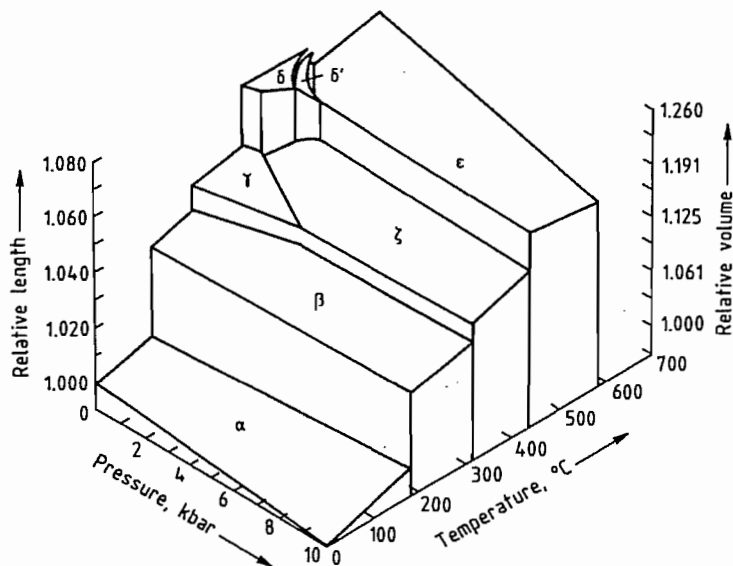

Figure 43.1: Pressure-temperature-volume diagram of plutonium.

## 43.2 Properties

### 43.2.1 Physical Properties

Plutonium is a silvery lustrous metal that exhibits five phase transitions (Table 43.2) between ambient temperature and its melting point (640 ± 2 °C). Under pressure an additional phase occurs.

Because of the different densities of each phase, large changes in expansion are observed during phase transitions, which complicates the use of plutonium for military purposes and as a fuel in nuclear power stations (Figure 43.1). Table 43.3 lists expansion coefficients, Figure 43.2 shows the heat capacity, and Figure 43.3 the magnetic susceptibility of the different phases. For further properties, see [1].

Measurements of the thermal conductivity of the different plutonium phases are not in agreement. For α-Pu at ambient temperature it ranges from 0.084 to 0.041 W cm<sup>-1</sup>K<sup>-1</sup>.

Table 43.3: Linear thermal expansion of plutonium [1].

Phase	Principal coefficient	Temperature range, °C	Mean coefficient, 10 <sup>-6</sup> °C <sup>-1</sup>
α	α <sub>a</sub>	-186 to +101	42.3
	α <sub>b</sub>	21-104	60
	α <sub>c</sub> = α <sub>b</sub>		75
	α <sub>β</sub>		29
	α <sub>γ</sub>		54
β	α <sub>β</sub>	93-190	94
	α <sub>γ</sub> = α <sub>β</sub>		14
	α <sub>δ</sub>		19
	α <sub>ε</sub>		42
γ	α <sub>δ</sub>	210-310	-19.7 ± 1.0
	α <sub>ε</sub>		39.5 ± 0.6
	α <sub>δ'</sub>		34.3 ± 1.6
	α <sub>ε</sub>		34.6 ± 0.7
δ	α	320-440	-8.6 ± 0.3
	α <sub>δ'</sub>		444.8 ± 12.1
δ'	α <sub>ε</sub>	452-480	-1063.5 ± 18.2
	α <sub>γ</sub>		-65.6 ± 10.1
	α <sub>β</sub>		
ε	α	490-550	36.5 ± 1.1
Liquid	α <sub>γ</sub>	664-788	93

### 43.2.2 Chemical Properties

Plutonium metal readily reacts with oxygen and moisture at ambient temperature, especially in bulk quantities due to self-heating.

The surface turns from grayish to dark blue and finally green oxide layers. In aqueous sodium chloride solution, it is converted to Pu(O)H. Plutonium dissolves rapidly in hydrochloric or hydrobromic acid but is only slowly attacked by hydrofluoric acid. It undergoes passivation in nitric acid but dissolves in the presence of fluoride ions. Sulfuric acid converts plutonium slowly to its sulfate.

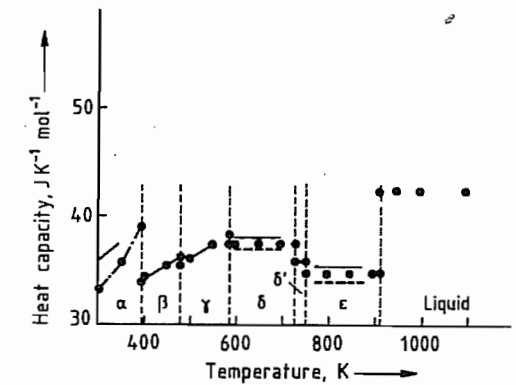

Figure 43.2: High-temperature heat capacity of plutonium metal. ● = Selected values.

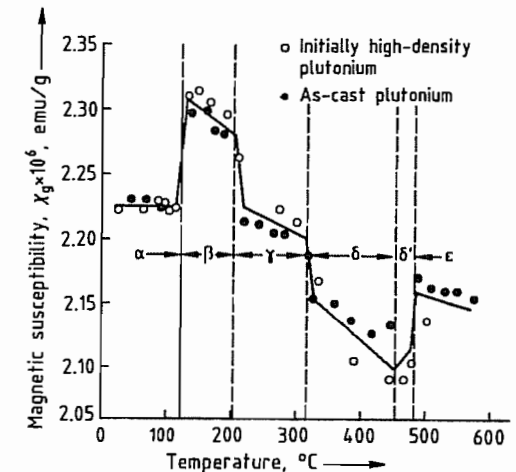

Figure 43.3: Magnetic susceptibility of plutonium as a function of temperature.

The behavior of plutonium in aqueous solution is unique. Five oxidation states exist: Pu<sup>3+</sup>, Pu<sup>4+</sup>, PuO<sub>2</sub><sup>+</sup>, PuO<sub>2</sub><sup>2+</sup>, and PuO<sub>5</sub><sup>3-</sup> (Table 43.4) of which up to four can be present simultaneously in significant quantities. The ions possess characteristic absorption bands that

are used in spectrophotometric analysis (Table 43.5). Standard potential schemes for plutonium in 1 mol/L HCl, neutral solution, and 1 mol/L OH<sup>-</sup> at 25 °C are shown below:

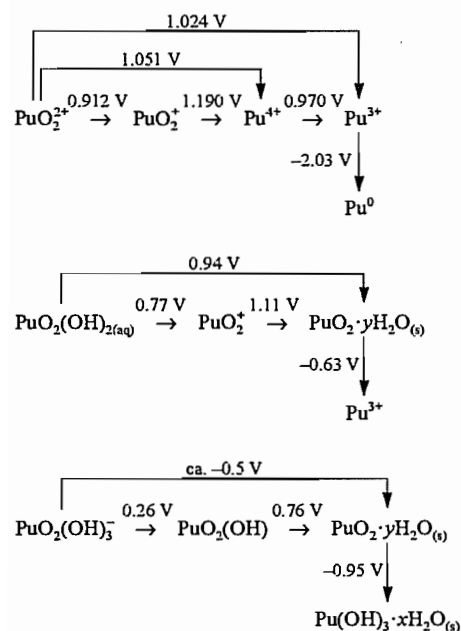

Table 43.4: Plutonium ions in aqueous solution.

Oxidation state	Form	Color
III	Pu <sup>3+</sup>	blue
IV	Pu <sup>4+</sup>	tan
IV	PuO <sub>2</sub> ·nH <sub>2</sub> O (polymer)	bright green, dark green
V	PuO <sub>2</sub> <sup>+</sup>	red-violet or pink
VI	PuO <sub>2</sub> <sup>2+</sup>	tan, orange (green)
VII	PuO <sub>5</sub> <sup>3-</sup>	blue

Table 43.5: Predominant absorption bands of plutonium ions.

Absorption bands, nm	Molal extinction coefficients			
	ε <sub>Pu(III)</sub>	ε <sub>Pu(IV)</sub>	ε <sub>Pu(V)</sub>	ε <sub>Pu(VI)</sub>
470	3.46	49.60	1.82	11.25
569	34.30	5.60	17.10	1.75
600	35.30	0.91	0.50	1.35
603	35.40	0.96	0.60	1.20
655	3.10	34.40	1.15	0.90
700	0.75	10.88	0.44	0.25
775	12.40	11.90	9.87	2.90
833	5.25	15.50	4.00	550
953	1.20	0.40	1.76	19.10

The plutonium cation Pu<sup>4+</sup> is initially hydrolyzed to a monomer before a colloidal polymer forms, preferably in slightly acidic solution. Depolymerization is very slow and requires heating in strong acid or oxidation.

The PuO<sub>2</sub><sup>+</sup> cation disproportionates readily at low acidity (Figure 43.4). The Pu<sup>4+</sup> cation forms complexes with anions of inorganic acids. The nitrate complexes Pu(NO<sub>3</sub>)<sub>x</sub><sup>(4-x)+</sup> (with x = 1–4) are employed for the separation of plutonium by solvent extraction and anion exchange. With organic compounds, various complexes have been observed. Ethylenediaminetetraacetic acid forms complexes with plutonium cations of all valences and is often used to decontaminate surfaces or to wash out ingested plutonium.

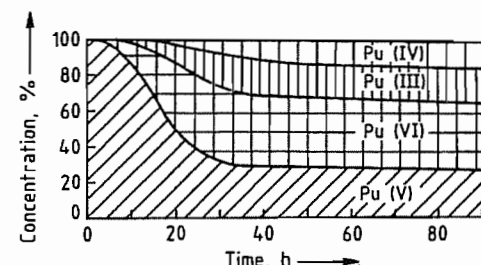
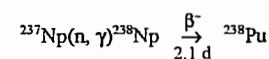

Figure 43.4: Change in composition of 0.1 mol/L HNO<sub>3</sub> Pu(V) solution by disproportionation.

### 43.3 Production

Bulk quantities of plutonium are produced through neutron capture by <sup>238</sup>U in nuclear reactors. Thus plutonium is a by-product of nuclear energy generation. The <sup>238</sup>Pu used as a heat source in nuclear batteries (for powering devices in space, pacemakers, etc.) is produced by the reaction



together with traces of <sup>239</sup>Pu, or by the reaction

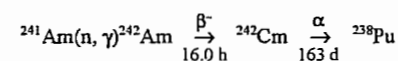

together with <sup>242</sup>Pu (17%), formed by branching decay of <sup>242</sup>Am.

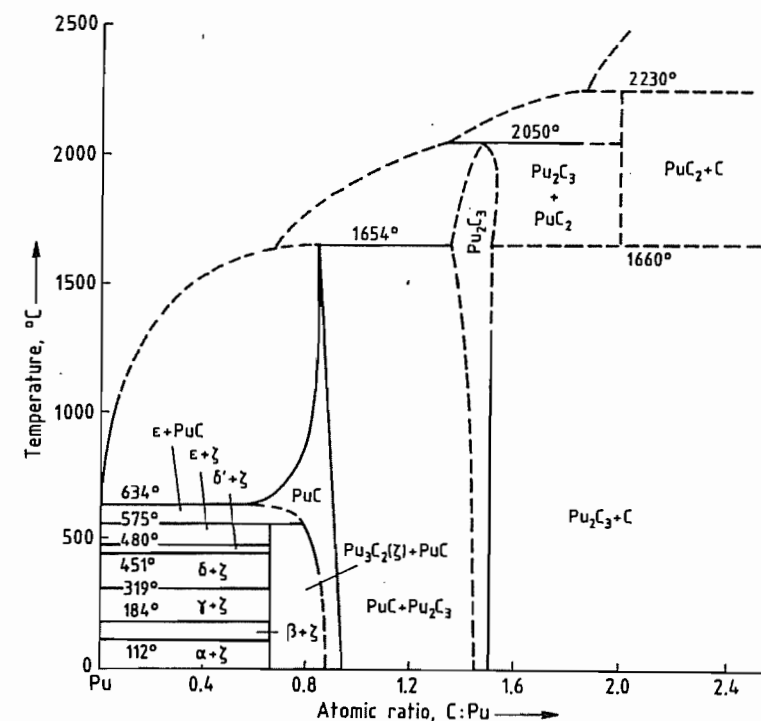

Figure 43.5: Phase diagram of plutonium-carbon system [4].

Plutonium from spent nuclear fuel is recovered by the PUREX process (liquid-liquid extraction of Pu with tri-*n*-butyl phosphate. Nonaqueous recovery by electrorefining from molten alkali-metal and alkaline earth metal chlorides is an alternative for metallic fuels. Plutonium metal is prepared from its oxide by reduction with calcium in molten CaCl<sub>2</sub> or CaCl<sub>2</sub>-CaF<sub>2</sub>.

### 43.4 Compounds [2, 3]

Like the other actinides, plutonium forms hard, black, metallic hydrides of the type PuH<sub>2+x</sub> and PuH<sub>3</sub>. They are inert to cold water but react slowly at 90 °C.

Four carbides of Pu exist: Pu<sub>3</sub>C<sub>2</sub>, PuC<sub>1-x</sub>, Pu<sub>2</sub>C<sub>3</sub>, and PuC<sub>2</sub> (Figure 43.5). They decompose at high temperature with peritectic reactions, are oxidized when heated, and dissolve in oxidizing acids with the formation of CO<sub>2</sub> and carboxylic acids (e.g., malonic acid).

Several silicides have been observed: PuSi, Pu<sub>3</sub>Si<sub>5</sub>, PuSi<sub>2</sub>, PuSi<sub>3</sub>, and Pu<sub>3</sub>Si<sub>2</sub>. They have a metallic appearance and are hard, brittle, and pyrophoric. They are oxidized in air and are attacked by water.

Pnictides exist for the elements N, P, As, Sb, and Bi: PuN is black (*mp* 2570 ± 30 °C, under 100 kPa N<sub>2</sub>), reacts slowly with cold but readily with hot water, and dissolves in mineral acids; PuP is a dark-gray compound that melts at 2600 °C under argon; PuAs has a gray metallic appearance; PuSb melts at 1980 ± 30 °C under 300 kPa Ar.

Chalcogenides exist for the elements O, S, Se, and Te: PuO<sub>2</sub> is a constituent of nuclear fuels. The plutonium oxygen phase diagram exhibits the existence of several oxides; their crystal data are listed in Table 43.6. The stoichiometric, metallically lustrous PuO, 5 melts at 2085 ± 25 °C and PuO<sub>2</sub> at 2390 ± 20 °C. Of technical relevance is the substoichiometric dioxide PuO<sub>2-x</sub> (x = 1.61–1.98), which acts as an oxygen sink in nuclear fuels, absorbing ox-

gen liberated during the fission process (and not bound by fission products). It is an olive-green compound like the stoichiometric  $\text{PuO}_2$ , which ranges in color from dull yellow to green and finally to black depending on the starting material that is converted to the oxide. Depending on the Pu:O ratio,  $\text{PuO}_{2-x}$  has a melting point ranging from 2430 to 2510 °C.

Plutonium hydroxides and hydrated oxides are obtained by precipitation from aqueous solution. With excess alkali-metal hydroxides or  $\text{NH}_4\text{OH}$ ,  $\text{Pu}^{3+}$  precipitates as blue or pale purple  $\text{Pu}(\text{OH})_3 \cdot x\text{H}_2\text{O}$ ,  $\text{Pu}^{4+}$  as olive-green  $\text{Pu}(\text{OH})_4 \cdot x\text{H}_2\text{O}$ , and  $\text{PuO}_2^{2+}$  as  $\text{PuO}_2(\text{OH})_2 \cdot \text{H}_2\text{O}$ . Addition of  $\text{H}_2\text{O}_2$  to solutions of  $\text{Pu}^{4+}$  in dilute acid leads to the formation of plutonium peroxide precipitates that contain about three peroxide groups per atom, together with varying amounts of anions (e.g.,  $\text{SO}_4^{2-}$ ,  $\text{NO}_3^-$ ).

Table 43.6: Crystal structure data for plutonium oxides.

Compound	Space group	Unit cell dimensions, pm	X-ray density, g/cm <sup>3</sup>	mp, °C
$\text{PuO}_{1.50}$	<i>P3m1</i>	$a = 384.1 \pm 0.6$ $c = 595.8 \pm 0.5$	11.47	2085 ± 25
$\text{PuO}_{1.51}$	<i>Ia3</i>	$a = 1104 \pm 2.0$	10.20	
$\text{PuO}_{1.61}$	<i>Ia3</i> or <i>Fm3m</i>	$a = 1095-1101$ or $a = 540.9$		
$\text{PuO}_2$	<i>Fm3m</i>	$a = 539.6 \pm 0.3$	11.46	2390 ± 20

Table 43.7: Annual limit of platinum uptake.

Radionuclide	Form <sup>a</sup>	Exposure of operators		Exposure of public	
		Annual limits of incorporation by inhalation, $10^{-9}$ Ci	Derived concentration limits in air for an exposure of 2000 h/a, $10^{-12}$ Ci/m <sup>3</sup>	Annual limits of incorporation by inhalation, $10^{-9}$ Ci	Annual limits of incorporation by ingestion, $10^{-6}$ Ci <sup>b</sup>
<sup>238</sup> Pu	W	5.4	2.4	0.54	
	Y	16	8.1	1.6	(a) 0.81 (b) 8.1
<sup>239</sup> Pu	W	5.4	2.2	0.54	
	Y	14	5.4	1.4	(a) 0.54 (b) 5.4
<sup>240</sup> Pu	W	5.4	2.2	0.54	
	Y	14	5.4	1.4	(a) 0.54 (b) 5.4
<sup>241</sup> Pu	W	270	110	27	
	Y	540	270	54	(a) 27 (b) 270
<sup>242</sup> Pu	W	5.4	2.4	0.54	
	Y	16	5.4	1.6	(a) 0.81 (b) 8.1

<sup>a</sup>W - week; Y = year.

<sup>b</sup>(a) = all compounds, except oxides and hydroxides; (b) = oxides and hydroxides.

Several plutonium sulfides exist, including  $\text{PuS}$ ,  $\text{Pu}_3\text{S}_4$ ,  $\text{Pu}_2\text{S}_3$ ,  $\text{PuS}_2$ , and various nonstoichiometric sulfides. All are black powders except  $\text{PuS}$ , which is brown. The following oxysulfides are known:  $\text{PuOS}$ ,  $\text{Pu}_4\text{O}_4\text{S}_3$ ,  $\text{Pu}_2\text{O}_2\text{S}$ , and  $\text{Pu}_2\text{O}_2\text{S}_3$ . Three selenides have been identified:  $\text{PuSe}$  (mp 2075 ± 30 °C, 300 kPa Ar);  $\text{Pu}_2\text{Se}_3$  ( $\eta$  and  $\gamma$  phase); and  $\text{PuSe}_{2-x}$  which decomposes above 600 °C.

In the Pu-Te system the following compounds have been observed:  $\text{PuTe}$  (mp 1870 ± 30 °C, 300 kPa Ar);  $\text{PuTe}_2$ , which decomposes when heated to give  $\text{PuTe}_{2-x}$ ; and two modifications of  $\text{Pu}_2\text{Te}_3$ . The compound  $\text{PuTe}_3$  is obtained by reacting plutonium hydride with excess tellurium.

The following halides and oxyhalides of plutonium are known:

$\text{PuF}_3$	violet-blue
$\text{PuF}_4$	pale brown
$\text{PuF}_4 \cdot n\text{H}_2\text{O}$	pink-white
$\text{PuF}_4 \cdot 2.5\text{H}_2\text{O}$	pink
$\text{PuF}_6$	reddish brown
$\text{PuCl}_3$	emerald green
$\text{PuCl}_3 \cdot 6\text{H}_2\text{O}$	blue
$\text{PuBr}_3$	green
$\text{PuBr}_3 \cdot 6\text{H}_2\text{O}$	blue
$\text{PuI}_3$	bright green
$\text{PuOF}$	metallic
$\text{PuOCl}$	blue-green
$\text{PuOBr}$	dark green
$\text{PuOI}$	green
$\text{PuO}_2\text{F}_2$	white
$\text{PuO}_2\text{Cl}_2 \cdot 6\text{H}_2\text{O}$	greenish yellow
$\text{PuO}_2\text{F}_4$	chocolate brown

The trifluoride and tetrafluoride hydrates are obtained by precipitation from aqueous solution. They undergo dehydration when heated in HF atmosphere to give  $\text{PuF}_3$  and  $\text{PuF}_4$ . Like its homologues,  $\text{PuF}_6$  is volatile (mp 52 °C, bp 62.15 °C).

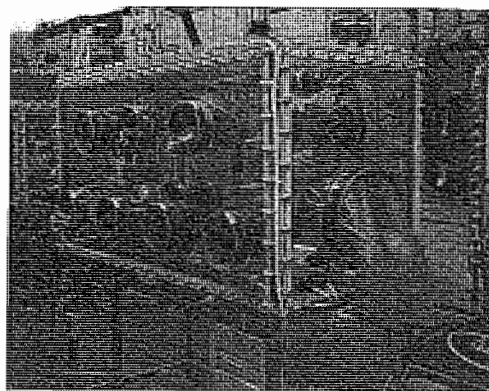

Figure 43.6: Glove box.

## 43.5 Toxicology

Because of its high radiotoxicity, plutonium is now handled exclusively in airtight glove boxes (Figure 43.6), which are under reduced pressure to prevent leakage of aerosols or volatile plutonium compounds in case of a containment rupture. Only very small quantities (in the range of microcuries) can be handled outside glove boxes with precautions, since the limits for ingestion and inhalation of plutonium are extremely low (Table 43.7). These limits [5] are based on the recommendations of the International Commission on Radiolog-

ical Protection. Compared to the radiological risks by incorporation, extracorporeal radiation by plutonium is relatively low. Here the same precautions are taken as for pure beta or gamma emitters.

**Control of the Risk by Incorporation.** In laboratories where plutonium is handled, personnel are protected against incorporation by

- Continuous monitoring of air
- Routine checks by body counters
- Routine urine analysis

For operations (e.g., bagging in and out of plutonium in glove boxes) where the risk of contamination exists, gas masks must be worn by the operator. Rooms housing glove boxes have reduced pressure and are vented through absolute filters. When leaving controlled laboratories, operators must check their clothing, hands, and feet for possible contamination.

### Release of Plutonium to the Environment.

In addition to stratospheric injection from nuclear weapons testing, plutonium may be released into the troposphere during routine or accidental release from nuclear reactor operation or fuel reprocessing. Simulation tests under typical meteorological conditions have found that 99% of 0.3- $\mu\text{m}$  particles are removed from the atmosphere in 3-60 d, whereas larger particles deposit more quickly. For plutonium deposited in the terrestrial ecosystem the transfer to humans via the food chain is reduced by a factor of at least  $10^8$  because of metabolic discrimination [6].

Characteristic discrimination factors (DF) for plutonium movement in the food chain are as follows:

$$\text{Soil} \rightarrow \text{plant and root uptake} \quad \text{DF}_{\text{plant/soil}} 10^{-4}-10^{-6}$$

$$\text{Crop plant} \rightarrow \text{humans} \quad \text{DF}_{\text{human/plant}} 10^{-4}$$

$$\text{Forage plants} \rightarrow \text{grazing animals} \quad \text{DF}_{\text{animal/plant}} 10^{-4}$$

$$\text{Plant} \rightarrow \text{grazing animal} \rightarrow \text{human beings} \\ \text{DF} = 10^{-4} \times 10^{-4} = 10^{-8}$$

where, for example,  $\text{DF}_{\text{plant/soil}}$  is the ratio of the plutonium concentration in the plant to the plutonium concentration in the soil.

Discrimination against plutonium also occurs at each level of the food chain for the up-

take from aquatic systems. A discrimination factor of  $10^{-4}$ – $10^{-5}$  was found between plankton and pelagic fish, depending on dietary habits. The ingestion of plutonium is different if it stems from the beginning of the food chain, such as algæ.

### 43.6 References

1. M. E. Hasbrouck: *Plutonium Metallurgy Notebook*, BNWL-37, Battelle Northwest Laboratory, Richland, WA, 1965.

2. J. J. Kak, G. T. Seaborg, L. R. Morss: *The Chemistry of the Actinide Elements*, 2nd ed., vol. 1, Chapman and Hall, London 1986.
3. *Gmelin*, vol. 7B.
4. H. Matzke: *Science of Advanced LMFBR Fuels*, Elsevier, Amsterdam 1986.
5. Official Journal of the European Communities, L265, vol. 27, 5th Oct. 1984.
6. *The Environmental and Biological Behaviour of Plutonium and some other Transuranium Elements*, OECD report, Paris 1981.

## Part Ten

### Rare Earth Metals

																			H	He				
Li	Be																		B	C	N	O	F	Ne
Na	Mg	Al																	Si	P	S	Cl	Ar	
K	Ca	Sc	Ti	V	Cr	Mn	Fe	Co	Ni	Cu	Zn	Ga	Ge	As	Se	Br	Kr							
Rb	Sr	Y	Zr	Nb	Mo	Tc	Ru	Rh	Pd	Ag	Cd	In	Sn	Sb	Te	I	Xe							
Cs	Ba	La <sup>†</sup>	Hf	Ta	W	Re	Os	Ir	Pt	Au	Hg	Tl	Pb	Bi	Po	At	Rn							
Fr	Ra	Ac <sup>‡</sup>																						

†	Ce	Pr	Nd	Pm	Sm	Eu	Gd	Tb	Dy	Ho	Er	Tm	Yb	Lu
---	----	----	----	----	----	----	----	----	----	----	----	----	----	----

‡	Th	Pa	U	Np	Pu	Am	Cm	Bk	Cf	Es	Fm	Md	No	Lr
---	----	----	---	----	----	----	----	----	----	----	----	----	----	----

## 44 General

IAN MCGILL

44.1	Introduction	1695	44.6.3	Separation by Ion Exchange	1711
44.2	History	1697	44.6.3.1	<i>Ion Exchange with Chelating Agents</i>	1711
44.3	Mineralogy, Abundance, Occurrence	1697	44.6.3.2	<i>Separation Processes</i>	1712
44.4	Properties	1700	44.6.3.3	<i>Industrial Processes</i>	1713
44.4.1	Properties of the Nuclei	1700	44.6.3.4	<i>Disadvantages of Ion Exchange</i>	1713
44.4.2	Properties of the Atoms and Ions	1700	44.6.4	Separation by Liquid-Liquid Extraction	1714
44.4.2.1	<i>Electronic Configuration, Position in the Periodic Table</i>	1700	44.6.4.1	<i>Theoretical Basis</i>	1714
44.4.2.2	<i>Oxidation States, Atomic and Ionic Radii</i>	1701	44.6.4.2	<i>Extractants</i>	1715
44.4.2.3	<i>Magnetic and Spectral Properties</i>	1702	44.6.4.3	<i>Industrial Liquid-Liquid Extraction</i>	1719
44.4.2.4	<i>Bonding, Coordination Numbers</i>	1703	44.7	Production of the Metals	1722
44.4.3	Other Chemical and Physical Properties	1704	44.7.1	Fused-Salt Electrolysis	1725
44.4.4	Miscibility and Alloying Behavior	1704	44.7.2	Metallothermic Reduction	1726
44.4.5	Mechanical Workability	1704	44.7.3	Purification	1727
44.5	Digestion of Ores	1706	44.8	Analysis	1727
44.5.1	Wet Digestion; Fusion	1706	44.9	Compounds	1728
44.5.1.1	<i>Monazite</i>	1707	44.9.1	Hydrides	1728
44.5.1.2	<i>Bastnaesite</i>	1707	44.9.2	Oxides, Hydroxides, Peroxides, Salts of Inorganic Oxoacids, Double Salts	1728
44.5.1.3	<i>Other Ores</i>	1708	44.9.3	Halides	1730
44.5.2	Chlorination	1708	44.9.4	Chalcogenides	1731
44.6	Separation	1708	44.9.5	Nitrides	1731
44.6.1	Principles of Separation	1709	44.9.6	Carbides	1731
44.6.2	Separation by Classical Methods	1710	44.9.7	Complexes; Organic Compounds	1732
44.6.2.1	<i>Fractional Crystallization</i>	1710	44.10	Uses	1732
44.6.2.2	<i>Fractional Precipitation</i>	1710	44.11	Economic Aspects	1736
44.6.2.3	<i>Separations Based on Oxidation State Changes</i>	1710	44.12	Toxicology	1737
			44.13	References	1737

### 44.1 Introduction

The metallic elements known collectively as the rare earths (better: rare earth metals or rare earth elements, abbreviated to RE) are listed in Table 44.1. General reviews are given in [1–6]. Originally, the name was only used for the sesquioxides,  $RE_2O_3$ , which are extraordinarily similar to one other in their chemical and physical properties and are therefore difficult to separate. Within the rare earth group, the elements scandium, yttrium, and lanthanum differ in their atomic structure (Table 44.2) from the elements cerium to lute-

tium (the lanthanides, Ln). The term lanthanoids has been proposed by IUPAC to include lanthanum and the lanthanides [7], but this usage is not yet universal. In the fields of mineralogy and geochemistry, the term cerium earths is used for the elements La and Ce to Eu, and yttrium earths for Y and Gd to Lu. Scandium occupies a special position with respect to this classification and its other properties, and therefore does not belong to either of these groups. The terms terbium earths for Eu, Gd, and Tb; erbium earths for Dy, Ho, Er, and Tm; and ytterbium earths for Yb and Lu are now hardly used. The rare earth elements al-

ways occur in nature in association with each other. The isolation of groups of rare earth elements or of individual elements requires costly separation and fractionation processes

owing to the great similarity of the chemical and physical properties of their compounds, which explains why the history of their discovery has extended over such a long period.

**Table 44.1:** Atomic numbers, relative atomic masses, and natural nuclides of the rare earth elements.

Element	Symbol	Atomic number	$M_r$	Mass numbers of the nuclides (abundance in %) <sup>a</sup>
Scandium	Sc	21	44.9559	45 (100)
Yttrium	Y	39	88.9059	89 (100)
Lanthanum	La	57	138.9055	138 (0.089; EC, $1.1 \times 10^{11}$ a), 139 (99.91)
Cerium	Ce	58	140.12	139 (0.139), 138 (0.250), 140 (88.48), 142 (11.07; $\beta^-$ , $5 \times 10^{15}$ a)
Praseodymium	Pr	59	140.9077	141 (100)
Neodymium	Nd	60	144.24	142 (27.11), 143 (12.17), 144 (23.85; $\alpha$ , $1 \times 10^{15}$ a), 145 (8.30), 146 (17.22), 148 (5.73), 150 (5.62)
Promethium	Pm	61	(145)	only radioactive isotopes
Samarium	Sm	62	150.4	144 (3.09), 147 (14.97; $\alpha$ , $1.06 \times 10^{11}$ a), 148 (11.24; $\alpha$ , $1.2 \times 10^{13}$ a), 149 (13.83; $\alpha$ , $4 \times 10^{14}$ a), 150 (7.44), 152 (76.72), 154 (22.71)
Europium	Eu	63	151.96	151 (47.82), 153 (52.18)
Gadolinium	Gd	64	157.25	152 (0.20), 154 (2.15), 155 (14.73), 156 (20.47), 157 (15.68), 158 (24.87), 160 (21.90)
Terbium	Tb	65	158.9254	159 (100)
Dysprosium	Dy	66	162.50	156 (0.052), 158 (0.090), 160 (2.29), 161 (18.88), 162 (25.53), 163 (24.97), 164 (28.18)
Holmium	Ho	67	164.9304	165 (100)
Erbium	Er	68	167.26	162 (0.136), 164 (1.56), 166 (33.41), 167 (22.94), 168 (27.07), 170 (14.88)
Thulium	Tm	69	168.9342	169 (100)
Ytterbium	Yb	70	173.04	168 (0.135), 170 (3.03), 171 (14.31), 172 (21.82), 173 (16.13), 174 (31.84), 176 (12.73)
Lutetium	Lu	71	174.97	175 (97.41), 176 (2.59; $\beta^-$ , $2.1 \times 10^{10}$ a)

<sup>a</sup>For the radioactive nuclides, the decay mode (EC = electron capture) and half-life is given in brackets as well as the abundance.

**Table 44.2:** Electronic configurations and spectroscopic terms of the gaseous rare earth elements in the ground state.

Symbol	RE <sup>0</sup>		RE <sup>2+</sup>		RE <sup>3+</sup>					
Sc	[Ar]	3d <sup>1</sup>	4s <sup>2</sup>	( <sup>2</sup> D <sub>3/2</sub> )	[Ar]	3d <sup>1</sup>	( <sup>2</sup> D <sub>3/2</sub> )	[Ar]	( <sup>1</sup> S <sub>0</sub> )	
Y	[Kr]	4d <sup>1</sup>	5s <sup>2</sup>	( <sup>2</sup> D <sub>3/2</sub> )	[Kr]	4d <sup>1</sup>	( <sup>2</sup> D <sub>3/2</sub> )	[Kr]	( <sup>1</sup> S <sub>0</sub> )	
La	[Xe]	5d <sup>1</sup>	6s <sup>2</sup>	( <sup>2</sup> D <sub>3/2</sub> )	[Xe]	5d <sup>1</sup>	( <sup>2</sup> D <sub>3/2</sub> )	[Xe]	( <sup>1</sup> S <sub>0</sub> )	
Ce	[Xe]	4f <sup>1</sup>	5d <sup>1</sup>	( <sup>1</sup> G <sub>4</sub> )	[Xe]	4f <sup>2</sup>	( <sup>3</sup> H <sub>4</sub> )	[Xe]	4f <sup>1</sup>	( <sup>2</sup> F <sub>5/2</sub> )
Pr	[Xe]	4f <sup>3</sup>	6s <sup>2</sup>	( <sup>4</sup> I <sub>9/2</sub> )	[Xe]	4f <sup>3</sup>	( <sup>4</sup> I <sub>9/2</sub> )	[Xe]	4f <sup>2</sup>	( <sup>3</sup> H <sub>4</sub> )
Nd	[Xe]	4f <sup>4</sup>	6s <sup>2</sup>	( <sup>3</sup> I <sub>4</sub> )	[Xe]	4f <sup>4</sup>	( <sup>3</sup> I <sub>4</sub> )	[Xe]	4f <sup>3</sup>	( <sup>4</sup> I <sub>9/2</sub> )
Pm	[Xe]	4f <sup>5</sup>	6s <sup>2</sup>	( <sup>6</sup> H <sub>5/2</sub> )	[Xe]	4f <sup>5</sup>	( <sup>6</sup> H <sub>5/2</sub> )	[Xe]	4f <sup>4</sup>	( <sup>3</sup> I <sub>4</sub> )
Sm	[Xe]	4f <sup>6</sup>	6s <sup>2</sup>	( <sup>7</sup> F <sub>0</sub> )	[Xe]	4f <sup>6</sup>	( <sup>7</sup> F <sub>0</sub> )	[Xe]	4f <sup>5</sup>	( <sup>6</sup> H <sub>5/2</sub> )
Eu	[Xe]	4f <sup>7</sup>	6s <sup>2</sup>	( <sup>8</sup> S <sub>7/2</sub> )	[Xe]	4f <sup>7</sup>	( <sup>8</sup> S <sub>7/2</sub> )	[Xe]	4f <sup>6</sup>	( <sup>7</sup> F <sub>0</sub> )
Gd	[Xe]	4f <sup>7</sup>	5d <sup>1</sup>	( <sup>9</sup> D <sub>2</sub> )	[Xe]	4f <sup>7</sup>	( <sup>9</sup> D <sub>2</sub> )	[Xe]	4f <sup>7</sup>	( <sup>8</sup> S <sub>7/2</sub> )
Tb <sup>a</sup>	[Xe]	4f <sup>8</sup>	6s <sup>2</sup>	( <sup>6</sup> H <sub>15/2</sub> )	[Xe]	4f <sup>8</sup>	( <sup>6</sup> H <sub>15/2</sub> )	[Xe]	4f <sup>7</sup>	( <sup>7</sup> F <sub>0</sub> )
Dy	[Xe]	4f <sup>10</sup>	6s <sup>2</sup>	( <sup>3</sup> I <sub>8</sub> )	[Xe]	4f <sup>10</sup>	( <sup>3</sup> I <sub>8</sub> )	[Xe]	4f <sup>8</sup>	( <sup>6</sup> H <sub>15/2</sub> )
Ho	[Xe]	4f <sup>11</sup>	6s <sup>2</sup>	( <sup>4</sup> I <sub>15/2</sub> )	[Xe]	4f <sup>11</sup>	( <sup>4</sup> I <sub>15/2</sub> )	[Xe]	4f <sup>10</sup>	( <sup>3</sup> I <sub>8</sub> )
Er	[Xe]	4f <sup>12</sup>	6s <sup>2</sup>	( <sup>3</sup> H <sub>6</sub> )	[Xe]	4f <sup>12</sup>	( <sup>3</sup> H <sub>6</sub> )	[Xe]	4f <sup>11</sup>	( <sup>4</sup> I <sub>15/2</sub> )
Tm	[Xe]	4f <sup>13</sup>	6s <sup>2</sup>	( <sup>2</sup> F <sub>7/2</sub> )	[Xe]	4f <sup>13</sup>	( <sup>2</sup> F <sub>7/2</sub> )	[Xe]	4f <sup>12</sup>	( <sup>3</sup> H <sub>6</sub> )
Yb	[Xe]	4f <sup>14</sup>	6s <sup>2</sup>	( <sup>1</sup> S <sub>0</sub> )	[Xe]	4f <sup>14</sup>	( <sup>1</sup> S <sub>0</sub> )	[Xe]	4f <sup>13</sup>	( <sup>2</sup> F <sub>7/2</sub> )
Lu	[Xe]	4f <sup>14</sup>	5d <sup>1</sup>	( <sup>2</sup> D <sub>3/2</sub> )	[Xe]	4f <sup>14</sup>	( <sup>2</sup> S <sub>1/2</sub> )	[Xe]	4f <sup>14</sup>	( <sup>1</sup> S <sub>0</sub> )

<sup>a</sup>For Tb<sup>0</sup>, possibly also 4f<sup>8</sup> 5d<sup>1</sup> 6s<sup>2</sup>.

**Table 44.3:** History of the discovery of the rare earth elements [6, 8].

Element	Year	Discoverer	Notes
Scandium	1879	NILSON	from ytterbium earths (DE MARIGNAC, 1878)
Yttrium	1843	MOSANDER	from yttrium earths (GADOLIN, 1794)
Lanthanum	1839–1841	MOSANDER	from cerium earths (KLAPROTH, BERZELIUS, HISINGER, 1803)
Cerium			
Praseodymium	1885	AUER V. WELSBACH	from didymium (MOSANDER, 1839–1841)
Neodymium			
Samarium	1901	DEMARCAV	from the samarium fraction (LECOQ DE BOISBAUDRAN, 1879) of didymium (MOSANDER, 1839–1841)
Europium			
Gadolinium	1886	LECOQ DE BOISBAUDRAN	from didymium (MOSANDER, 1839–1841), independently of each other
	1880	DE MARIGNAC	
Terbium	1878	DE MARIGNAC DELAFontaine	from terbium earth (DELAFontaine, 1878), originally named terbium earth (MOSANDER, 1843)
Dysprosium	1886	LECOQ DE BOISBAUDRAN	from the holmium fraction (CLEVE, 1879) of the erbium earth (DE MARIGNAC, 1878)
Holmium	1879	CLEVE	
Erbium	1879	CLEVE	from erbium earth (DE MARIGNAC, 1878)
Thulium	1879	CLEVE	from the holmium fraction (CLEVE, 1879) of erbium earth (DE MARIGNAC, 1878)
Ytterbium	1878	DE MARIGNAC	from ytterbium earth (DE MARIGNAC, 1878)
Lutetium	1907	URBAIN AUER V. WELSBACH JAMES	from ytterbium earth, independently of each other (DE MARIGNAC, 1878)

## 44.2 History

The discovery of the rare earths is summarized in Table 44.3, with the exception of the radioactive element promethium. Further details are given in [8]. The word "rare", when used to describe this group of elements, originates from the fact it was thought that the rare earth elements could only be isolated from very rare minerals. Considering the abundance of the rare earth elements in the Earth's crust, the term rare is inappropriate.

## 44.3 Mineralogy, Abundance, Occurrence

The rare earth elements are lithophilic and are therefore concentrated in oxidic compounds such as carbonates, silicates, titanotantaloniobates, and phosphates, or form minerals of these types on their own [6, 9] (see also [1, parts A4, A5]). The formation of the minerals is influenced by variations in ionic radii, crystallochemical factors such as coordination number, basicity, potential for isomor-

phic replacement, tendency to form complexes, and differences in oxidation states [10], (see also [2, vol. 3, pp. 1–80]). These factors lead to the division of the rare earth elements into three groups, according to the mineralization process (REO denotes the rare earth sesquioxides):

- Minerals that contain lanthanum to neodymium, samarium, and europium, and in which cerium and, in some cases also lanthanum or neodymium, are present as the main components (cerium earths, Ce...). Typical examples of this group include bastnæsite (Ce...)<sub>2</sub>FeCO<sub>3</sub> (max. 75% REO content), monazite (Ce...)<sub>2</sub>PO<sub>4</sub> (max. 65% REO content), and allanite (Ca, Ce...)<sub>2</sub>(Fe, Al)<sub>3</sub>(SiO<sub>4</sub>)<sub>3</sub>(OH) (max. 28% REO content).
- Minerals with gadolinium to lutetium and yttrium as main components (yttrium earths, Y...). Typical examples of this group are xenotime (Y...)<sub>2</sub>PO<sub>4</sub> (max. 62% REO content) and gadolinite (Y...)<sub>2</sub>FeBe<sub>2</sub>Si<sub>2</sub>O<sub>10</sub> (max. 48% REO content). Typical compositions of bastnæsite, monazite, and xenotime from

various mineral resources are given in Table 44.4.

- Complex minerals in which both yttrium earths and cerium earths can be represented in the same mineral type, either of these groups of rare earths being the main one. Minerals of this type are oxidic ores containing titanium, niobium, tantalum, uranium, and thorium; for example:

Euxenite (Y..., Ce...)(Nb, Ta, Ti)<sub>2</sub>O<sub>6</sub>

Samarskite (Y..., Ce...)<sub>4</sub>(Nb, Ta, Ti)<sub>2</sub>O<sub>6</sub>

Fergusonite (Y...)(Nb, Ti, Ta)O<sub>4</sub>

Betafite (U, Ca, Y..., Ce...)<sub>2</sub>(Nb, Ta, Ti)<sub>2</sub>O<sub>6</sub>(OH)

The minerals of the first two groups occur in pegmatites and metamorphic gneisses, as well as hydrothermal and pneumatolytic veins, and in skarns and carbonatites. The minerals of the third group are mainly found in pegmatites.

Useful concentrations (up to 5%) of rare earth elements occur in apatite Ca<sub>5</sub>(F, Cl, OH)(PO<sub>4</sub>)<sub>3</sub> (see typical composition in Table 44.4), and up to 10% in pyrochlor (Na, Ca, Ce...)<sub>2</sub>(Nb, Ta, Ti)<sub>2</sub>(O, OH, F)<sub>7</sub>, and loparite (Na, Ca, Ce...)<sub>2</sub>(Nb, Ta, Ti)<sub>2</sub>O<sub>6</sub> in the Kola Peninsula (CIS), and also in most uranium minerals as trace substituents.

Scandium occurs in trace amounts in most rare earth minerals along with the true rare earth elements (e.g., as a substituent ion of the same valency). However, the amounts are very small. Thortveitite, Sc<sub>2</sub>Si<sub>2</sub>O<sub>7</sub>; sterretite, ScPO<sub>4</sub>·2H<sub>2</sub>O; and kolbeckite (Sc, Be, Ca) (SiO<sub>4</sub>, PO<sub>4</sub>)·2H<sub>2</sub>O are genuine scandium minerals. Apart from scandium, thortveitite also contains yttrium, ytterbium, and lutetium.

In many minerals, scandium is present in a dispersed state. Wolframite and cassiterite can contain up to 1% scandium, so that scandium is a by-product of the production of tungsten and tin. Uranium minerals contain much smaller amounts of scandium, but, since uranium is produced in relatively large quantities, scandium is produced in appreciable quantities also.

The abundance of the rare earth elements taken together is quite considerable. Cerium, the most common rare earth, is more abundant than, e.g., Co. Yttrium is more abundant than, e.g., Pb, whereas genuinely rare REs such as Lu and Tm are as abundant as Sb, Hg, Bi, and Ag. Promethium in rare earth minerals is present only in amounts of < 10<sup>-19</sup>% as a result of nuclear reactions with cosmic rays or the spontaneous fission of <sup>238</sup>U.

Table 44.4: Rare earth content (% of total REO) in typical minerals.

	Monazite		Bastnæsinite		Xenotime	Apatite
	Australia	China	United States	China	Malaysia	CIS
Cerium earths	94.940	92.090	99.547	98.600	10.500	90.100
La <sub>2</sub> O <sub>3</sub>	23.900	23.350	33.200	23.000	0.500	25.100
CeO <sub>2</sub>	46.030	45.690	49.100	50.000	5.000	45.000
Pr <sub>6</sub> O <sub>11</sub>	5.050	4.160	4.340	6.200	0.700	3.900
Nd <sub>2</sub> O <sub>3</sub>	17.380	15.740	12.000	18.500	2.200	14.000
Sm <sub>2</sub> O <sub>3</sub>	2.530	3.050	0.789	0.800	1.900	1.600
Eu <sub>2</sub> O <sub>3</sub>	0.050	0.100	0.118	0.200	0.200	0.500
Yttrium earths	5.060	7.910	0.315	1.400	89.500	7.250
Gd <sub>2</sub> O <sub>3</sub>	1.490	2.030	0.166	0.700	4.000	1.500
Tb <sub>4</sub> O <sub>7</sub>	0.040	0.100	0.016	0.100	1.000	0.100
Dy <sub>2</sub> O <sub>3</sub>	0.690	1.020	0.031	0.100	8.700	1.000
Ho <sub>2</sub> O <sub>3</sub>	0.050	0.100	0.005	trace	2.100	0.100
Er <sub>2</sub> O <sub>3</sub>	0.210	0.510	0.004	trace	5.400	0.150
Tm <sub>2</sub> O <sub>3</sub>	0.010	0.510	0.001	trace	0.900	0.020
Yb <sub>2</sub> O <sub>3</sub>	0.120	0.510	0.001	trace	6.200	0.080
Lu <sub>2</sub> O <sub>3</sub>	0.040	0.100	trace	trace	0.400	trace
Y <sub>2</sub> O <sub>3</sub>	2.410	3.030	0.091	0.500	60.800	4.300
Total	100.000	100.000	99.862	100.000	100.000	97.350

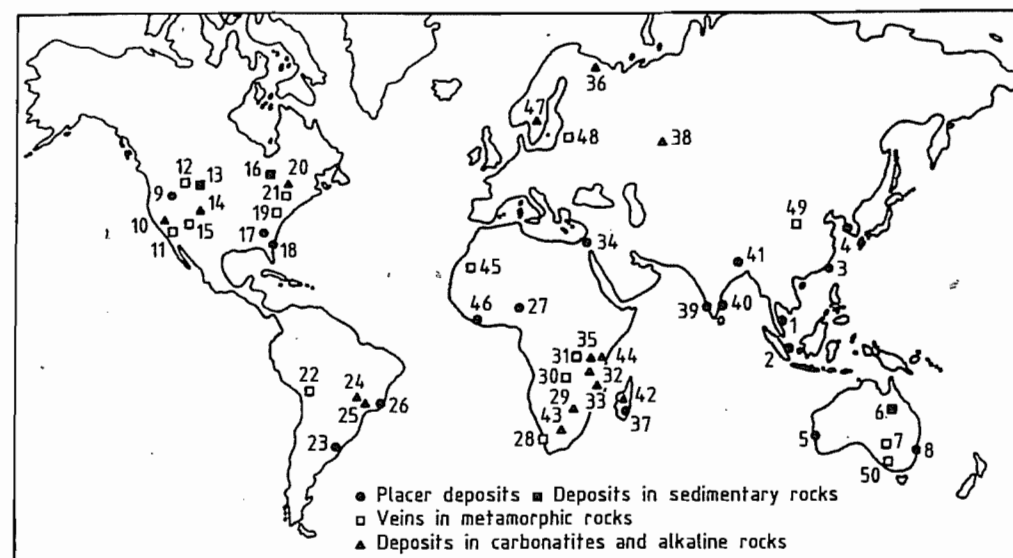

Figure 44.1: Important rare earth deposits [11]. 1) Malaysia; w) Singkep, Billit and Bangka, Indonesia; 3) Taiwan; 4) Korea; 5) Western Australia; 6) Mary Kathleen Mine, Australia; 7) Radium Hill, Australia; 8) New South Wales, Australia; 9) Bear Valley, Idaho/Montana; 10) Mountain Pass, California; 11) Music Valley, California; 12) Mineral Hill/Lenhi Pass, Idaho/Montana; 13) Bald Mountain, Wyoming; 14) Powderhorn and Wet Mountains, Colorado; 15) Gallinas Mountains, New Mexico; 16) Blind River/Elliot Lake, Ontario; 17) Piedmont, Georgia; 18) Atlantic Coast placer deposits; 19) Dover, New Jersey; 20) Oka, Québec; 21) Mineville, New York; 22) Llallagua, Bolivia; 23) Atlanida, Uruguay; 24) Araxa, Brazil; 25) Morro do Ferro, Brazil; 26) Espirito Santo, Brazil; 27) Jos Plateau, Nigeria; 28) Steenkampskraal, South Africa; 29) Glenover, South Africa; 30) Shinkolobwe, Zaire; 31) Karonge, Burundi; 32) Panda Hill, Tanzania; 33) Kangakunde Hill, Malawi; 34) Nile Delta, Egypt; 35) Mrima, Kenya; 36) Kola Peninsula, CIS; 37) Madagascar; 38) Vishnevye Mountains, CIS; 39) Kerala, India; 40) Sri Lanka; 41) Bihar and Bengal; 42) Iremo, Madagascar; 43) Pilanesberg, Bophuthatswana; 44) Wigu Hill, Tanzania; 45) Bon Nage Mauretania; 46) Monrovia, Liberia; 47) Fen, Norway; 48) Kangasala, Finland; 49) Bayan Obo, Inner Mongolia; 50) Roxby Downs, Australia.

The rare earth minerals of the three groups referred to above occur in distinct deposits (Figure 44.1) [11]. Perhaps the most important mined rare earth deposit is at the Mountain Pass Mine in California (carbonatite), where up to 40 000 t/a bastnæsinite ore concentrate (70% REO) is produced by ore beneficiation. Other important bastnæsinite deposits are in Burundi (carbonatite), Madagascar (alkali rock), and in Bayan Obo, near the town of Baotou in Inner Mongolia in China. The bastnæsinite, with monazite, is associated with magnetite-hematite-fluorspar.

Monazite mainly occurs in secondary deposits in the heavy minerals of coastal sands. The extraction of monazite is closely linked with the extraction of rutile, ilmenite, and zircon in Australia, Brazil, India, and the United States, and with the extraction of cassiterite in

Indonesia, Malaysia, Thailand, Nigeria, and Zaire. However, this also means that the amount of monazite available depends on the demand for the main product. These monazites contain up to ca. 10% thorium. Xenotime is found in similar deposits, Malaysian monazite having particularly high xenotime contents.

Primary monazite deposits with high thorium contents are found in Brazil, and particularly in South Africa, though these are not extracted at present. Low-thorium monazites occur in primary carbonatitic deposits in Malawi and Burundi.

The minerals of the third group are extracted mainly for their Nb, Ta, and U contents.

In 1990, world reserves of rare earth minerals were estimated at ca. 84 × 10<sup>6</sup> t REO.



China has estimated reserves of  $43 \times 10^6$  t REO (ca. 50% of the world reserves). The Baiyunebo deposit near Baotou in Inner Mongolia is the largest source of rare earth minerals in the world and accounts for over half of the Chinese production. The bastnæsite deposit at Mountain Pass, California, contains an estimated reserve of  $4.3 \times 10^6$  t REO representing approximately 5% of world reserves. Total reserves within the United States currently amount to  $12.6 \times 10^6$  t REO.

Reserves elsewhere have been estimated as follows: Australia:  $5.1 \times 10^6$  t REO, India:  $2.3 \times 10^6$  t REO, Canada:  $0.95 \times 10^6$  t REO, CIS:  $0.45 \times 10^6$  t REO, Brazil:  $0.28 \times 10^6$  t REO, and others, excluding the United States and China,  $19.63 \times 10^6$  t REO.

The production of bastnæsite concentrate at the Mountain Pass Mine, California reached a peak in 1984 of 25 312 t REO. In 1990, production totalled 22 829 t REO, representing approximately 27% of world production [12]. Estimated monazite production expressed as rare earth oxide (REO) in 1990 was as follows: Australia: 6500 t, Brazil: 1900 t, India: 2030 t, Malaysia: 1740 t, South Africa: 1000 t, United States: 2000 t, and the CIS: 1500 t.

Raw material prices in early 1990 for bastnæsite from the United States with 70% REO was \$1.3/lb, reflecting an increased use of cerium oxide in autocatalysts, glass additives, and polishing compounds. From 1988 to 1991, the price of Australian monazite with > 55% REO was stable between A\$800–900/t; Malaysian xenotime as 60% yttrium concentrate cost \$32–33/kg.

## 44.4 Properties

### 44.4.1 Properties of the Nuclei

Some naturally occurring nuclides of the rare earth elements are radioactive. Data on types of radioactive decay and half-lives are given in Table 44.1. Radioactive properties of artificial rare earth nuclides are given in [13]. Promethium, Pm, whose occurrence in nature was sought for a long time without success,

was first identified with certainty in 1945 by MARINSKY et al. as a radioactive fission product of uranium [14].

So far, 25 relatively short-lived isotopes of Pm are known (longest half life: 17.7 years for  $^{145}\text{Pm}$ ). ERÄMETSÄ [15] isolated traces of  $^{145}\text{Pm}$  from the rare earth concentrate of an apatite in 1965, and deduced that the abundance of Pm in nature is  $< 10^{-19}\%$ . The question whether this is produced by natural uranium fission or by the action of cosmic rays on  $^{146}\text{Nd}$  is the subject of debate.

The very high thermal neutron absorption cross section of several nuclides of Sm, Eu, and Gd is noteworthy.

### 44.4.2 Properties of the Atoms and Ions

#### 44.4.2.1 Electronic Configuration, Position in the Periodic Table

The electronic configurations of neutral, isolated atoms of the rare earth elements in the ground state (Table 44.2) lead to the following position of the rare earth elements in the periodic table: the elements Sc, Y, and La are the first members of a series of transition elements (*d*-elements) with the valence electron configuration  $ns^2(n-1)d^1$  ( $n = 4, 5, \text{ or } 6$ ). The 14 elements, Ce–Lu, constitute a series of inner transition elements ("*f*-elements") which must be inserted between La and Hf. These are the lanthanides, with valence electron configurations of the type  $6s^2 5d^1 4f^{n-1}$  or  $6s^2 4f^n$ . Thus, all the rare earth elements belong formally to Group 3 of the Periodic System.

In the neutral atoms, the *5d* and *4f* electrons have similar energies. This fact explains the occurrence of the two typical electronic configurations referred to above within the lanthanide series (Table 44.2), whereby the configurations  $4f^7$  (half-filled orbital) and  $4f^1 4$  (completely filled orbital) are preferred owing to the high thermodynamic stability of such states. The irregularity of the configurations of the two elements immediately before the middle and the end of the lanthanide series, Eu and

Yb, are characteristic of the neutral atoms and the mono- and divalent ions. However, in the case of the trivalent ions, the *4f* orbital is filled in a completely regular manner. The energy of the *4f* orbital decreases with increasing atomic number and increasing ionic charge, so that when the valency is 3+, which is characteristic of the rare earth elements, the *4f* electrons represent well-defined "inner electrons" that take virtually no part in chemical bonding due to their proximity to the nucleus and shielding by the  $5s^2 5p^6$  octet. Therefore, the regular filling of the *4f* orbital from  $\text{Ce}^{3+}$  to  $\text{Lu}^{3+}$  determines the chemical properties, as the resulting electronic configurations resemble those of the rare gases, and lead to the great similarity of the  $\text{Ln}^{3+}$  compounds to each other, to the corresponding compounds of  $\text{La}^{3+}$ ,  $\text{Y}^{3+}$ , and, to a limited extent, to those of  $\text{Sc}^{3+}$ .

Table 44.5: Atomic radii and effective ionic radii of the rare earth elements (in nm).

Symbol	Atom <sup>a</sup>	$\text{RE}^{2+}$ <sup>b</sup>	$\text{RE}^{3+}$ <sup>c</sup>	$\text{RE}^{4+}$ <sup>d</sup>
Sc	0.1654		0.0730	
Y	0.1824		0.0892	
La	0.1884		0.1061	
Ce	0.1825		0.1034	0.096 <sup>e</sup>
Pr	0.1836		0.1013	0.095
Nd	0.1829		0.0995	
Pm	0.1825		0.0979	
Sm	0.1814	0.1232	0.0964	
Eu	0.1984	0.1220	0.0950	
Gd	0.1817		0.0938	
Tb	0.1803		0.0923	0.088
Dy	0.1796		0.0908	
Ho	0.1789		0.0894	
Er	0.1780		0.0881	
Tm	0.1769	0.1127 <sup>e</sup>	0.0869	
Yb	0.1932	0.1115	0.0858	
Lu	0.1760		0.0848	

<sup>a</sup>Half the interatomic distance for the modification stable at room temperature, calculated from lattice constants [17, 18].

<sup>b</sup>For coordination number 8 in difluorides with  $r_{\text{F}^-} = 0.132$  nm [20].

<sup>c</sup>For coordination number 6 [19].

<sup>d</sup>For coordination number 8 in dioxides with  $r_{\text{O}^{2-}} = 0.138$  nm.

<sup>e</sup>Estimated.

The regular filling of the *4f* orbital is accompanied by a steady reduction in the  $\text{Ln}^{3+}$  ionic radii (Table 44.5, [17–20], and Figure 44.2)—the so-called lanthanide contraction. This steady shrinkage of the inner electron shell is mainly caused by the incomplete mu-

tual shielding of the *4f* electrons against the increasing attraction of the nucleus.

The peculiarities of the electronic structure of the rare earth elements described here lead to periodic changes in some physical and chemical properties of these elements and their compounds in the series La to Lu, while other properties show a steady or nonperiodic change. The typical similarity of the rare earth elements to each other, which is often emphasized, is in essence only exhibited for the nonperiodic properties. Thus, the regular change in the  $\text{RE}^{3+}$  radii leads to largely nonperiodic changes in properties that depend on ion size, such as solubility, basicity, normal potential, and enthalpy of hydration. Periodic variation in properties can have various causes and cannot be interpreted with certainty in all cases. Typically, maxima or minima occur at Eu and Yb, because they are situated immediately before the *4f* shell is half filled ( $4f^7$ ) or completely filled ( $4f^{14}$ ) and attempt to achieve these stable configurations. Periodic variations are observed for atomic radii, molecular volumes, melting points, boiling points, and sublimation enthalpies of the elements. A similar periodicity is also observed in some dissociation enthalpies of gaseous molecules  $\text{REX}$  ( $X = \text{chalcogenide}$ ) due to certain peculiarities in the electronic configurations [16]. Other types of pronounced periodicity occur, e.g., in magnetic moments and colors of the  $\text{RE}^{3+}$  ions.

#### 44.4.2.2 Oxidation States, Atomic and Ionic Radii

The oxidation state 3+ is characteristic for all rare earth elements, both for solid compounds and for solvated ions in various solvents. The oxidation state 2+ can occur in pure solid compounds of Eu, and, to a slightly lesser extent, Yb, due to the higher stability of the configurations  $4f^7$  and  $4f^{14}$ . It is also observed to a very limited extent with Sm and Tm. In aqueous solutions,  $\text{Eu}^{2+}$  ions are metastable. All the other  $\text{Ln}^{2+}$  ions react in acidic media as reducing agents:

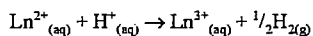

The oxidation state 4+ can occur for Ce and Tb, which follow La and Gd respectively, and also to a very limited extent for Pr and Nd. Only the Ce<sup>4+</sup> ion is metastable in aqueous solution; The other Ln<sup>4+</sup> ions oxidize water as follows:

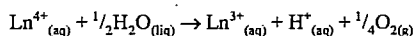

The general preference for the oxidation state 3+ in aqueous solution is probably a consequence of the similarity between the hydration enthalpy and ionization enthalpy of the ions. The standard electrode potentials listed in Table 44.6 [8] illustrate the behavior of the various RE<sup>n+</sup> ions in aqueous solution, and show that the rare earths are a group of highly nonnoble elements. Figure 44.2 shows the atomic radii (in the metallic state) and ionic radii for the various typical valencies. The periodicity of the atomic radii described above (maxima for Eu and Yb) shows that in the metallic state these elements contribute only two electrons to the bond, so that their atomic volumes are similar to those of the alkaline earth metals. The radii of the Ln<sup>2+</sup> ions, plus the radius of the Ba<sup>2+</sup> ion, give a curve resembling the lanthanide contraction curve, and the term baride contraction has been suggested to describe this [21]. The radii of Eu<sup>2+</sup> and Sr<sup>2+</sup> are similar, as are the radii of Yb<sup>2+</sup> and Ca<sup>2+</sup>, which explains the commonly observed isomorphous replacement of alkaline earth ions by Ln<sup>2+</sup> ions of similar size.

The similarity of the chemical properties of Ln<sup>3+</sup> compounds to those of the corresponding compounds of La<sup>3+</sup> and Y<sup>3+</sup> can be explained by the similarities between the sizes of these ions. Therefore, as expected, in the case of those properties that are mainly determined by ion size, La should be placed near Ce, and Y between Ho and Er. However, for scandium, which has a comparatively small radius ( $r_{\text{Sc}^{3+}} = 0.0730$  nm), there is a greater similarity to the chemistry of aluminum ( $r_{\text{Al}^{3+}} = 0.0530$  nm) than to that of lutetium ( $r_{\text{Lu}^{3+}} = 0.0848$  nm).

Table 44.6: Standard electrode potentials  $E^{\circ}_{298}$  of the rare earth elements in volts [8] (much of the data is estimated).

Element	RE <sub>(s)</sub> /RE <sup>3+</sup> <sub>(aq)</sub>	RE <sup>2+</sup> <sub>(aq)</sub> /RE <sup>3+</sup> <sub>(aq)</sub>	RE <sup>3+</sup> <sub>(aq)</sub> /RE <sup>4+</sup> <sub>(aq)</sub>
Sc	+2.077		
Y	+2.372		
La	+2.522		
Ce	+2.483		-1.74
Pr	+2.462		ca. -2.86
Nd	+2.431		
Pm	+2.423		
Sm	+2.414	+1.55	
Eu	+2.407	+0.43	
Gd	+2.397		
Tb	+2.391		-1.28
Dy	+2.353		
Ho	+2.319		
Er	+2.296		
Tm	+2.278		
Yb	+2.267	+1.15	
Lu	+2.255		

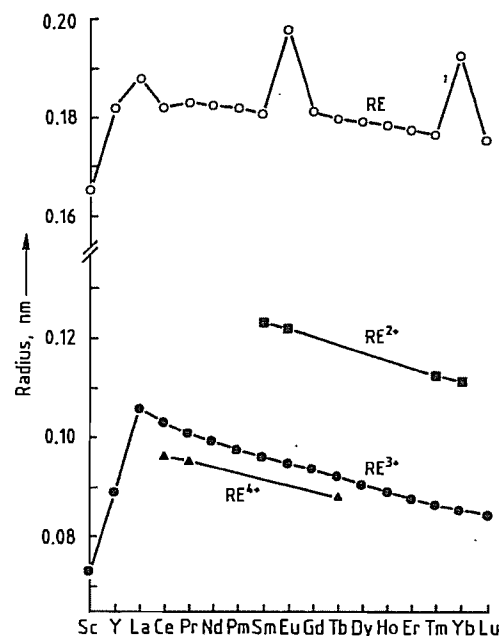

Figure 44.2: Atomic and ionic radii of the rare earth elements.

#### 44.4.2.3 Magnetic and Spectral Properties

The electronic configurations and spectroscopic terms of the Ln<sup>3+</sup> ions are largely unaffected by the type of compound in which they are situated, owing to the shielding of the 4f

electrons from the chemical environment by the 5s<sup>2</sup>6p<sup>6</sup> octet. For these ions, with the exception of Sm<sup>3+</sup> and Eu<sup>3+</sup>, it is characteristic that the values of the total spins  $J$  applicable to the spectroscopic term of the ground state differ from each other fairly widely (difference at room temperature  $> kT$ ) so that in the ground state practically only one  $J$  value is occupied. This peculiarity has interesting consequences for the magnetic properties of these ions. While Sc<sup>3+</sup>, Y<sup>3+</sup>, La<sup>3+</sup>, and Lu<sup>3+</sup> are diamagnetic due to their closed shells, the remaining Ln<sup>3+</sup> ions are paramagnetic (Figure 44.3). The double maximum in the curve of permanent magnetic moments can be explained theoretically by the additive behaviour of the spin and orbital moments [3, vol. 1, pp. 310–350; 22]. These moments are in opposition for the elements before gadolinium, but additive for the elements that follow it. The magnetic moment of Gd<sup>3+</sup> is due entirely to the electron spin. The magnetic moments of the Ln<sup>2+</sup> and Ln<sup>4+</sup> ions mainly correspond to those of the isoelectronic Ln<sup>3+</sup> ions. Also, there is a noticeable difference between the magnetic properties of the lanthanides and those of the 3d transition elements, which are characterized by paramagnetism mainly due to spin.

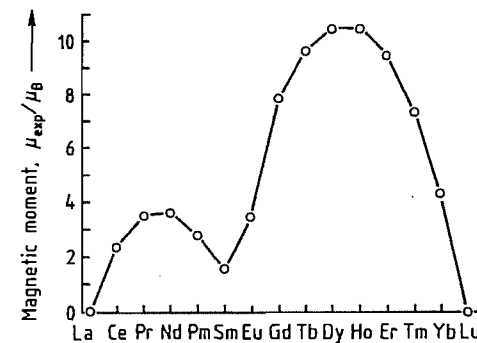

Figure 44.3: Magnetic moments of the RE<sup>3+</sup> ions at 300 K.

The Ln<sup>3+</sup> ions, with the exception of Ce<sup>3+</sup> and Yb<sup>3+</sup>, have very sharp absorption bands in the visible region and partly in the ultraviolet (Table 44.7). These bands are caused by  $f \rightarrow f$  transitions. Their sharpness is due to the above-mentioned shielding of the 4f inner shell, which greatly hinders splitting of the

spectroscopic terms by external fields. The colors of the Ln<sup>3+</sup> ions are given in Table 44.7 [8]. The sequence of colors in the series La to Gd is almost exactly repeated in the opposite direction in the series Gd to Lu. The ions Ce<sup>3+</sup> and Yb<sup>3+</sup> do not absorb in the visible region because an  $f \rightarrow f$  transition is not possible for the configurations 4f<sup>1</sup> and 4f<sup>13</sup>. The broad absorption bands of these ions in the ultraviolet region are due to configuration transitions of the type 4f<sup>n</sup>  $\rightarrow$  4f<sup>n-1</sup> 5d<sup>1</sup>.

In aqueous solution, Eu<sup>2+</sup> is pale yellow, Sm<sup>2+</sup> is deep red, and Yb<sup>2+</sup> is yellow.

Table 44.7: Colors and main absorption bands of RE<sup>3+</sup> ions in the range 200–1000 nm [8].

Ion	Wavelength, nm	Color
La <sup>3+</sup>		colorless
Ce <sup>3+</sup>	210.5, 222.0, 238.0, 252.0	colorless
Pr <sup>3+</sup>	444.5, 469.0, 482.2, 588.5	yellow-green
Nd <sup>3+</sup>	354.0, 521.8, 574.5, 739.5, 742.0, 797.5, 803.0, 868.0	red-violet
Pm <sup>3+</sup>	548.5, 568.0, 702.5, 735.5	pink
Sm <sup>3+</sup>	362.5, 374.5, 402.0	yellow
Eu <sup>3+</sup>	375.5, 394.1	colorless
Gd <sup>3+</sup>	272.9, 273.3, 275.4, 275.6	colorless
Tb <sup>3+</sup>	284.4, 350.3, 367.7, 487.2	very pale pink
Dy <sup>3+</sup>	350.4, 365.0, 910.0	pale yellow-green
Ho <sup>3+</sup>	287.0, 361.1, 416.1, 450.8, 537.0, 641.0	yellow
Er <sup>3+</sup>	364.2, 379.2, 7487.0, 522.8, 652.5	pink
Tm <sup>3+</sup>	360.0, 682.5, 780.0	pale green
Yb <sup>3+</sup>	975.0	colorless
Lu <sup>3+</sup>		colorless

#### 44.4.2.4 Bonding, Coordination Numbers

The physical, chemical, and above all structural properties of the rare earth compounds indicate that these elements exhibit mainly ionic bonding.

In solution and in crystalline compounds, the RE<sup>3+</sup> ions (except Sc<sup>3+</sup>) generally have coordination numbers  $> 6$  [8]. For scandium compounds, which can also be regarded as homologues of aluminum, coordination numbers  $> 6$  do not occur. In general, the tendency of the lanthanides, including Y and La, to form complexes is smaller than for the d-transition elements, as the shielded 4f orbitals are not available for forming the hybrid orbitals that

form covalent bonds. Also, the very large size of the  $\text{Ln}^{3+}$  ions compared with other triply charged cations leads to smaller electrostatic forces of attraction.

#### 44.4.3 Other Chemical and Physical Properties [1, part B6; 23]

**Reactivity.** Apart from Eu, which is very readily oxidized under all conditions, the metals react at room temperature with oxygen or dry air relatively slowly, and in moist air rapidly. At elevated temperatures, all rare earth metals ignite in air and react with most non-metallic elements. In dilute mineral acids, rapid dissolution takes place with formation of  $\text{RE}^{3+}$  ions. Like the alkaline earth metals, europium and ytterbium form deep blue, strongly reducing solutions in liquid ammonia.

**Crystal Structure.** Most of the rare earth metals are polymorphic. At room temperature, Sc, Y, Gd to Tm, and Lu crystallize in the hexagonal close-packed system, and La, Pr, and Nd in the double hexagonal close-packed (La type) system. The metals Ce and Yb crystallize in the face-centered cubic system. Sm is rhombohedral, and Eu body-centered cubic. Whenever the body-centered cubic modification occurs, it is always the stable high-temperature form up to the melting point.

**Melting Point.** The melting points are in the range 816 °C (Yb) to 1663 °C (Lu), and the boiling points lie between 1194 °C (Yb) and 3512 °C (Pr). Eu and Yb have a certain resemblance to the heavy alkaline earth metals in their melting points, boiling points, and molar volumes. Other physical data are listed in Table 44.8 [1, 2, 4].

#### 44.4.4 Miscibility and Alloying Behavior

If trivalent Eu and Yb and tetravalent Ce and Tb are excluded, the atomic radii from La to Lu differ by only 8% for coordination number 12, so that in all alloy systems of adjacent

rare earth metals there is complete gap-free miscibility in the liquid state and also in a temperature region close to the solidus curve. The liquidus curves are always continuous, corresponding to the behavior of almost ideal mixtures [24–26].

The mutual effect of atomic radius and electronegativity on the formation of mixed crystals between the rare earth metals and other metals is shown in Figure 44.4 [27], in which La and Lu are given as examples. The nearby elements (within the inner ellipse), exhibit extensive miscibility in the solid state. At a greater distance (within the outer ellipse), they have limited miscibility with the rare earth elements. Elements outside the ellipses have such large differences that only slight solubility in the solid state can be expected. Thus, all transition elements of the adjacent groups 4–8 are soluble to a maximum extent of 1% in the solid state.

In Figure 44.5 [2], the compositions of intermetallic compounds between various elements and the rare earth metals are shown. The vertical lines show the region in which intermetallic phases exist, while the horizontal lines show the phases themselves. The most important of these are the phases  $\text{REX}_2$ ,  $\text{REX}$ , and  $\text{REX}_3$ . The phase containing the highest proportion of rare earth metal is  $\text{RE}_3\text{X}$ . There is no lower limit; for example, a compound  $\text{REB}_{66}$  is known (see also [28–31]).

#### 44.4.5 Mechanical Workability

When casting rare earth metals in molds they must be melted in crucibles made of materials with which they do not react. Depending on the purity required, tantalum, molybdenum, clay/graphite, graphite, or boron nitride, etc. can be used. Inert gas atmospheres, vacuum, or sometimes only a covering salt may also be required. The castings are easily machined by turning, milling, drilling, or sawing, though care must be taken that the pyrophoric character of the metals does not lead to spontaneous ignition of the turnings or powdered material produced.

Table 44.8: Properties of the rare earth elements [2, 4].

	Density, g/cm <sup>3</sup>		Lattice constants, nm		Crystal structure of stable phase at room temperature (high-temperature polymorphs) <sup>a</sup>	Electron emission, eV	Electrical resistivity, μΩ cm	Grüneisen constant for temperature dependence of electrical resistivity	Poisson's ratio	Compression modulus, 10 <sup>10</sup> Nm <sup>-2</sup>	Shear modulus, 10 <sup>10</sup> Nm <sup>-2</sup>	Modulus of elasticity, 10 <sup>10</sup> Nm <sup>-2</sup>	Vickers hardness	Thermal conductivity, Wcm <sup>-1</sup> K <sup>-1</sup>	Linear coefficient of expansion, 10 <sup>-6</sup> K <sup>-1</sup>	Specific heat capacity at 25 °C, Jmol <sup>-1</sup> K <sup>-1</sup>	bp, °C	Heat of fusion, kJ/mol	mp, °C	Abundance in Earth's crust, ppm	
	a	c	a	c																	
Sc	5–10	1540	0.33085	0.52683	a (d)	3.5	52	1.03	0.309	6.65	2.88	7.55	85 <sup>b</sup>	10.0	25.5	2832	15.5	1540	5–10	1540	
Y	28–70	1525	0.36482	0.57318	a (d)	3.1	60	1.00	0.265	4.15	2.55	6.36	38	10.8	26.5	3337	11.4	1525	28–70	1525	
La	5–18	920	0.3774	1.2159	b (c, d)	2.96	61	0.66	0.284	3.03	1.49	3.84	37	4.9	26.2	3457	6.2	920	5–18	920	
Ce	20–46	798	0.51610	6.770	c (b, d)	2.97	77	0.47	0.248	2.00	1.20	3.00	24 <sup>c</sup>	8.5	27.0	3427	5.5	798	20–46	798	
Pr	3.5–5.5	931	0.36721	1.18326	b (d)	2.96	71	0.49	0.305	2.99	1.35	3.52	37 <sup>c</sup>	6.79	27.0	3512	6.9	931	3.5–5.5	931	
Nd	12–24	1016	0.36582	1.17926	b (d)	3.0	64	0.74	0.306	3.27	1.45	3.79	35	9.98	27.5	3067	7.1	1016	12–24	1016	
Pm	<10 <sup>-15</sup>	1042	0.365	1.165	b (d)	2.85	54	(0.72)	0.306	1.32	0.87	2.14		0.179	ca. 3000	24.3	8	<10 <sup>-15</sup>	1042	<10 <sup>-15</sup>	1042
Sm	4.5–7	1073	0.3621	2.625	b (a, d)	2.7–2.8	94	0.63	0.352	3.87	1.26	3.41	45	10.4	29.6	1791	8.6	1073	4.5–7	1073	
Eu	0.14–1.1	822	0.45824	5.243	d	3.20	90	1.64	0.259	3.78	2.23	5.62	17 <sup>c</sup>	33.1	27.7	1597	9.2	822	0.14–1.1	822	
Gd	4.5–6.4	1312	0.36360	0.57810	a (d)	3.20	131	0.52	0.261	4.01	2.28	5.75	57	8.28	37.1	3267	10.1	1312	4.5–6.4	1312	
Tb	0.7–1	1357	0.36055	0.56966	a (d)	3.25	124	0.83	0.261	4.01	2.28	5.75	46	10.3	28.9	3222	10.8	1357	0.7–1	1357	
Dy	4.5–7.5	1409	0.35915	0.56501	a (d)	3.15	93	0.78	0.243	4.11	2.54	6.31	42	10.0	28.2	2562	10.8	1409	4.5–7.5	1409	
Ho	0.7–1.2	1470	0.35778	0.56178	a (d)	3.18	94	0.89	0.255	4.01	2.67	6.71	42	10.7	27.2	2695	12.2	1470	0.7–1.2	1470	
Er	2.5–6.5	1522	0.35592	0.55850	a	3.10	90	1.01	0.238	4.55	2.96	7.33	44	12.3	28.1	2862	19.9	1522	2.5–6.5	1522	
Tm	0.2–1	1545	0.35375	0.55540	a	2.59	72	1.08	0.284	4.98	0.70	1.78	48	13.3	27.0	1927	16.9	1545	0.2–1	1545	
Yb	2.7–8	816	0.54862	6.965	c (d)	3.35	25	0.98	0.284	1.30	0.70	1.78	21 <sup>c</sup>	25.0	26.7	1194	7.7	816	2.7–8	816	
Lu	0.8–1.7	1663	0.55052	9.840	a	59	59	0.66	0.284	4.766	2.715	6.846	77	12.5	26.9	3397	14.0	1663	0.8–1.7	1663	

<sup>a</sup> a = hexagonal close packed (hcp); b = double hexagonal close packed (dhcp); c = face-centered cubic; d = body-centered cubic; r = rhombohedral.

<sup>b</sup> Rockwell hardness.

<sup>c</sup> Heated to red heat.

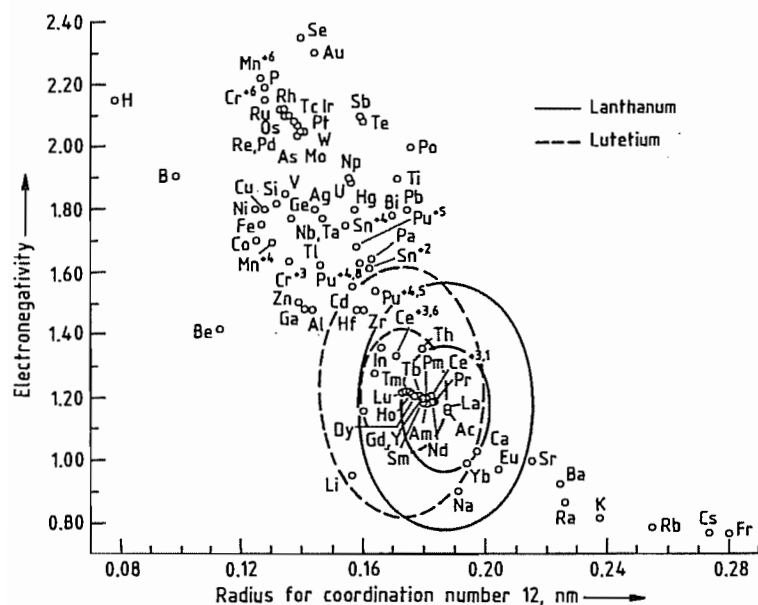

Figure 44.4: Darken-Gurry diagram for lanthanum and lutetium [27].

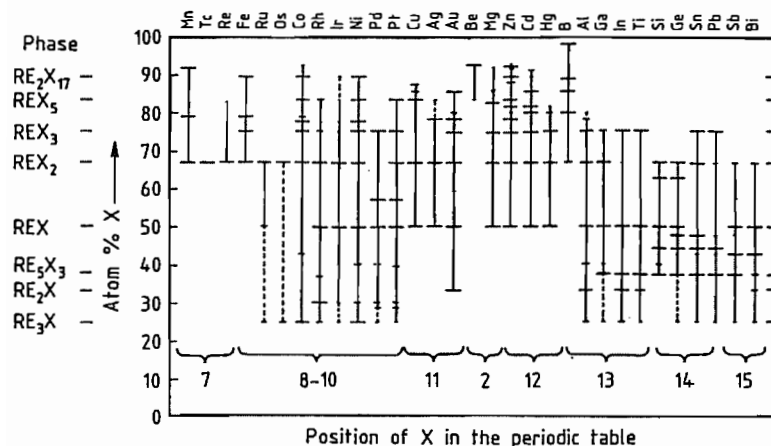

Figure 44.5: Compositions of binary rare earth alloys [2, vol. 2, chap. 13, pp. 1-54].

Rare earth metals can easily be extruded at temperatures just below the melting point. The presence of impurities, especially oxygen, has a detrimental effect on cold and hot rolling properties.

## 44.5 Digestion of Ores

### 44.5.1 Wet Digestion; Fusion

The most important rare earth minerals monazite, bastnæsité, and xenotime are generally concentrated by physical processes such as heavy medium separation, flotation, and magnetic separation [1, part B1, pp. 60-67]. They are ground to 50  $\mu\text{m}$ -1 mm and then di-

gested with acids or alkalis. Treatment with alkalis produces the hydroxides of the rare earth metals and thorium, which can then be dissolved in concentrated hydrochloric or nitric acid. Treatment of the ores with sulfuric or hydrochloric acid converts the rare earth metals into soluble sulfates or chlorides [1, part B1, pp. 67-104].

#### 44.5.1.1 Monazite

**Digestion by Alkalis.** The reaction of rare earth phosphates with hot, concentrated alkali (50-75%) proceeds as follows:

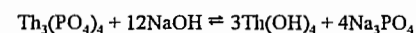
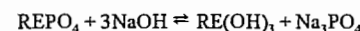

This can be carried out at high temperatures in autoclaves (60% alkali, mass ratio 1:1) [32], or with more concentrated alkali at lower temperature (120 °C) and normal pressures [33].

The hydroxides produced are treated with hot water. The trisodium phosphate goes into solution, and the hydroxides are filtered off. The trisodium phosphate, a saleable by-product, crystallizes out. The washed hydroxides are then dissolved in hydrochloric or nitric acid. If the acid concentration is held at pH 4, a partial separation results, impure thorium hydroxide remaining behind while the rare earth hydroxides dissolve.

**Sulfuric Acid Digestion.** Monazite can be digested with 98% sulfuric acid at 200-230 °C. The rare earth sulfates formed are then dissolved out of the crystalline, hygroscopic reaction product with cold water. The thorium sulfate either remains undissolved or also goes into solution, depending on the reaction conditions [34].

The dissolved thorium, which was at one time the most important product, was formerly precipitated as sulfate. However, the sharpness of separation from the rare earth elements was poor. The method now used is to dissolve all the sulfates and separate the thorium by one of the following more effective methods:

- Precipitation of  $\text{ThF}_4$ .

- Precipitation of thorium phosphate by increasing the pH or by dilution.
- Precipitation of the sodium/cerium earth double sulfates, while the corresponding much more readily soluble salts of thorium and the yttrium earths remain in solution. The thorium is then precipitated by adding oxalic acid, the solubility of thorium oxalate being much lower than that of the oxalates of the yttrium earths. The sparingly soluble double sulfates of the cerium earths are treated with boiling, concentrated alkali solution, forming the hydroxides, which are then dissolved in acid for subsequent fractionation.

#### 44.5.1.2 Bastnæsité

**Digestion with Acids.** Many processes have been described for digesting bastnæsité with sulfuric acid. In one of these, the mineral is calcined to decompose the carbonates and then treated with 6 N sulfuric acid to dissolve the rare earth elements as sulfates [35].

In another process, the mineral is slurried with concentrated sulfuric acid and heated to 500 °C. The fluorine is driven off as hydrogen fluoride together with  $\text{CO}_2$  and  $\text{SO}_2$ , and the rare earth elements remain behind as their anhydrous sulfates [36]. These can then be treated like the products from the treatment of monazite with sulfuric acid.

In another process, the mineral is calcined at > 600 °C, and then treated with 16 N nitric acid, which is considerably more effective than 12 N hydrochloric acid or 18 N sulfuric acid [37].

In the Molycorp process, the mineral is concentrated to 60% by flotation and then calcined, converting the cerium to the tetravalent state. It is then treated with hydrochloric acid, which causes only the trivalent rare earth elements to go into solution, leaving behind 65-80%  $\text{CeO}_2$ , which can be converted directly to a glass-polishing material by further calcination [38].

In another process, the carbonates are decomposed by hydrochloric acid. A fluoride residue is obtained, which is treated with al-

kali. The rare earth hydroxides obtained in this way are used to neutralize the excess acid from the chloride solution [39].

**Digestion with Bases.** Bastnæsite can be treated with concentrated alkali at ca. 200 °C to form rare earth hydroxides, which are then dissolved in acid [40].

#### 44.5.1.3 Other Ores

Xenotime is more difficult to digest than monazite. It is usually treated with concentrated alkali, like monazite, but under much more rigorous conditions. Rare earth silicate minerals are best digested with sulfuric acid at fairly high temperatures. Various methods have been described for the extraction of the rare earth elements from apatites during wet production of phosphoric acid [41, 42]. A process for the direct treatment of apatite with  $\text{NOCl}/\text{NO}_2/\text{N}_2\text{O}_4$  at high temperatures is proposed in [43].

In the field of uranium production, only Denison Mines (Ontario) have so far produced an yttrium concentrate by solvent extraction of a sulfate solution.

#### 44.5.2 Chlorination

The direct chlorination of rare earth ores in a shaft furnace at 1000–1200 °C produces two groups of chlorides, depending on the impurities present. These are firstly the chlorides volatile at this temperature such as  $\text{AlCl}_3$ ,  $\text{FeCl}_3$ ,  $\text{POCl}_3$ ,  $\text{SiCl}_4$ ,  $\text{ThCl}_4$ ,  $\text{TiCl}_4$ ,  $\text{NbOCl}_3$ ,  $\text{NbCl}_5$ , and  $\text{TaCl}_5$ , and secondly the nonvolatile chlorides of the alkali and alkaline earth metals as well as the rare earth chlorides, which collect at the bottom of the chlorinating furnace and are tapped off. The anhydrous rare earth chlorides can be treated, without further drying, by molten salt electrolysis to produce cerium mischmetal or they can be dissolved for further wet chemical processing.

The reaction of bastnæsite or monazite proceeds according to the following equations:

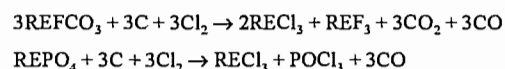

The rare earth ore, with a grain size of < 0.2 mm, is pelletized with charcoal powder and a binder. It is then dried and fed into the chlorination furnace (Figure 44.6). This consists essentially of a vessel lined with refractory bricks, inside which is a carbon cylinder that is the actual reaction space. A perforated graphite tube located inside this carbon cylinder contains a bed of coke through which the chlorine gas is passed to ensure even distribution before it passes through the solid feed material. The reaction is energetically self-sustaining, and only requires sufficient resistance heating to compensate for radiation losses. The rare earth chlorides collect in the melt space and are tapped off from time to time. A total of ca. 400 t rare earth chlorides can be produced during the working life of the carbon cylinder. The cylinder can be replaced without difficulty while hot. The output of a chlorination furnace of this type is ca. 100 t/month. The lining of the chlorination furnace has a lifetime corresponding to a total output of 1500 t rare earth chloride.

The chlorination furnace operates at a slight underpressure. The waste gases are passed into a combustion chamber, oxidized, and washed with alkali to remove residual chlorine. In principle, it is possible to recover the volatile chlorides of valuable elements from the off-gas stream (e.g.,  $\text{POCl}_3$ ,  $\text{NbCl}_5$ ,  $\text{TiCl}_4$ ,  $\text{TaCl}_5$ ,  $\text{ThCl}_4$ ,  $\text{UCl}_4$ ).

#### 44.6 Separation

The separation of the rare earth elements poses one of the most difficult problems in inorganic chemistry. Due to the great similarity of the chemical properties, the methods are generally not very selective. In a few cases, much better separation can be achieved by conversion to another oxidation state of adequate stability ( $\text{Ce}^{3+} \rightarrow \text{Ce}^{4+}$ ,  $\text{Eu}^{3+} \rightarrow \text{Eu}^{2+}$ ).

A further difficulty is presented by the unfavorable distribution of concentrations of individual rare earth metals in the common minerals. The method of separation must therefore be selected to suit the existing ratios.

The first step is a preliminary separation into groups of elements that resemble each other very closely.

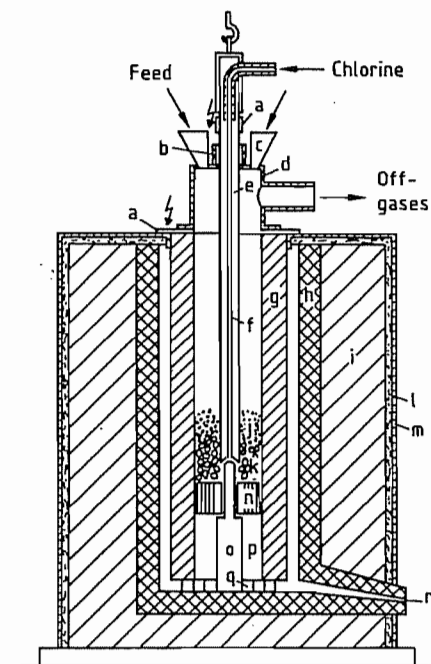

Figure 44.6: Diagram of a chlorination furnace [44, 45]: a) Electrical connection; b) Insulation and seal; c) Charging tunnel; d) Furnace hood; e) Central electrode; f) Central hole for chlorine feed; g) Insert; h) Inner refractory lining; i) Outer refractory lining; j) Charge materials; k) Layer of coke; l) Slag wool; m) Iron casing; n) Sieve plate; o) Sieve plate supports; p) Space for molten material; q) Exit holes in insert; r) Tapping hole.

#### 44.6.1 Principles of Separation

Two principal types of process are used for the extraction of rare earth elements:

- Solid-liquid systems using fractional precipitation or crystallization, or ion exchange. Ion exchange processes are used in the production of small quantities of higher value heavy rare earth elements.
- Liquid-liquid systems using solvent extraction. This process is the most commonly used commercial process for the extraction of rare earth elements.

The distribution of two rare earth elements REA and REB between the two phases is given by the equilibrium constants  $k_A$  and  $k_B$ :

$$k_A = \frac{[\overline{\text{RE}}_A]}{[\text{RE}_A]} \quad \text{and} \quad k_B = \frac{[\overline{\text{RE}}_B]}{[\text{RE}_B]}$$

where  $[\text{RE}]$  and  $[\overline{\text{RE}}]$  represent the concentrations in the aqueous and nonaqueous phase, respectively. The selectivity of this separation system is given by the separation factor  $\alpha_{\text{RE}_B/\text{RE}_A}$ , where

$$\alpha_{\text{RE}_B/\text{RE}_A} = k_B/k_A$$

More correctly, activities should be used instead of concentrations. In practice, apparent equilibrium constants based on concentrations are adequate. In the following discussion, these apparent constants are used throughout.

The processes of fractional crystallization or fractional precipitation are now mainly of historic interest only. The separation factor corresponds to the solubility ratio of the two rare earth elements in the aqueous phase.

In the case of ion exchange or liquid-liquid extraction, the ratio of the distribution coefficients is a measure of the different affinities of the rare earth metals for the two phases.

For the trivalent ions of neighboring rare earth elements, the separation factor is low for all methods. For precipitation or crystallization,  $\alpha = 1.1$  to 5; for separation by ion exchange with addition of complexing agents,  $\alpha = 1.1$  to 10; for liquid-liquid extraction,  $\alpha = 1.1$  to 5.

For an effective separation, many repetitions of a single separation operation are necessary, which can be carried out batchwise or continuously.

With ion exchange separation, although the establishment of equilibrium is continually repeated, the overall process is discontinuous, since continuous feeding is not possible. However, it has the advantage that several rare earth elements can be separated at the same time.

A fully continuous liquid-liquid extraction process in countercurrent flow with partial recycle enables separation to be achieved into two groups or two individual rare earth ele-

ments of high purity. The production of three pure rare earth elements requires two batteries of separation equipment. This limitation is, however, compensated for by the advantage of continuous operation.

A further characteristic of a separation process is the size of the apparatus required. This depends on the concentration of the rare earth elements in the two phases. Cationic ion exchangers have a high capacity (ca. 150 g REO/L), but elution in the presence of complexing agents requires very dilute solutions (ca. 5–10 g REO/L). These separation plants are therefore very bulky.

In the liquid–liquid extraction process, the capacity of the solvent can be very high (170–190 g REO/L), and it is therefore often possible to work with aqueous solutions with concentrations of 100–140 g REO/L, i.e., approaching saturation. The equipment is therefore compact.

## 44.6.2 Separation by Classical Methods [1, part B2; 3, vol. 1, pp. 30–61; 6]

### 44.6.2.1 Fractional Crystallization

Fractional crystallization was the first process for separating the rare earth elements, both in the laboratory and on the industrial scale. It is no longer of importance.

The purification effect decreases with increasing purity of the crystals. The achievable purity is therefore limited. Also, many intermediate fractions are produced that must be reprocessed.

In general, this process is more problematical for the yttrium earths than the cerium earths. The cerium earths were therefore separated by fractional crystallization and the yttrium earths by ion exchange. The cerium earths were converted to nitrates after oxidation of the cerium to the tetravalent state, and the double nitrates  $\text{NH}_4\text{NO}_3 \cdot \text{RE}(\text{NO}_3)_3 \cdot 4\text{H}_2\text{O}$  were crystallized. Pechiney Saint Gobain produced 99.9% pure lanthanum in five crystallization stages, this salt being the most soluble. The yttrium was first precipitated as the dou-

ble chromate and then purified by ion exchange.

### 44.6.2.2 Fractional Precipitation

Fractional precipitation was only used for separating the rare earth elements into groups, due to filtration difficulties and the slow establishment of equilibrium.

The best known example is the precipitation of the hydroxides, which enables separation into three groups: (1) yttrium, (2) praseodymium, neodymium, and samarium, and (3) a fraction enriched in lanthanum and cerium.

Another process is the precipitation of double sulfates,  $\text{Na}_2\text{SO}_4 \cdot \text{RE}_2(\text{SO}_4)_3$ . The greater solubility of the yttrium earths enables a crude separation from the cerium earths to be carried out.

### 44.6.2.3 Separations Based on Oxidation State Changes

Cerium(IV) or europium(II) can be economically separated from the other rare earth metals by precipitation, ion exchange, or liquid–liquid extraction.

Cerium can be oxidized by oxidizing agents such as hypochlorite,  $\text{H}_2\text{O}_2$ , atmospheric oxygen, or electrolytically at a suitable pH, precipitating it as cerium(IV) oxide hydrate. By adding chlorine and sodium hydroxide solution to a solution of cerium earth chlorides, cerium(IV) oxide hydrate is precipitated. This can be converted to a 90% pure cerium oxide that is suitable for use as a polishing material. The separation of tetravalent cerium from the trivalent rare earth elements by liquid–liquid extraction is described later.

Divalent europium has properties similar to those of the alkaline earths, especially strontium (insoluble sulfate, soluble hydroxide, etc.). The rare earth metals are usually reduced in hydrochloric acid solution by zinc amalgam or sodium amalgam. The subsequent precipitation of europium sulfate from the very dilute solution can be improved by coprecipitation of

strontium or barium sulfate. The europium can be further purified by precipitating trivalent elements as their hydroxides by using ammonia. Under these conditions,  $\text{Eu}^{2+}$  remains in solution [46]. The separation of divalent europium from the trivalent rare earth elements by liquid–liquid extraction is described later.

### 44.6.3 Separation by Ion Exchange

This process is based on work carried out on the separation of rare earth elements produced by uranium fission, and formed part of the Manhattan Project (1943–1947). The principles of separation by elution were developed by BOYD and coworkers in the Oak Ridge National Laboratory. The Ames Laboratory, Iowa State University, under the leadership of SPEDDING, investigated the production of rare earth metals on a large scale by displacement elution. SPEDDING and POWELL have provided review of the developments up to 1950 [5, pp. 55–73; 47]. Attempts to develop ion exchange column chromatography into a continuous process was realized with the development of the continuous annular chromatograph by researchers at Oak Ridge Laboratory in the mid 1970s. However, the process was designed for analytical requirements with low loading of the columns and was therefore not commercialized [48–50]. A more recent development, known as continuous displacement chromatography [51], shows greater promise for surpassing present industrial, batch, fixed-column displacement ion exchange processes.

#### 44.6.3.1 Ion Exchange with Chelating Agents

Sulfonated polystyrene ion exchange resins, which possess high chemical stability, can combine with 0.5–0.8 mol of rare earth elements per 1 mol resin. However, differences in the affinities of the rare earth elements for the resin are very small, and the separation factor for two neighboring rare earth elements is only ca. 1.08 [52]. However, this can be con-

siderably improved by the addition of chelating agents.

The separation factor  $F_{\text{RE}_B/\text{RE}_A}$  for two rare earth elements  $\text{RE}_A$  and  $\text{RE}_B$  between an aqueous solution and the cation exchanger (concentrations marked with a bar) is

$$F_{\text{RE}_B/\text{RE}_A} = \frac{\overline{[\text{RE}_B^{3+}]} \cdot [\text{RE}_A^{3+}]}{[\text{RE}_A^{3+}] \cdot \overline{[\text{RE}_B^{3+}]}}$$

On the addition of a chelating agent  $L$ , the equilibrium constants in solution are given by:

$$K_A = \frac{[\text{RE}_A L]}{[\text{RE}_A] \cdot [L]} \quad K_B = \frac{[\text{RE}_B L]}{[\text{RE}_B] \cdot [L]}$$

The constants depend on conditions in the medium, especially the pH of the aqueous phase. For large values of  $K_B$  and  $K_A$  and an excess of chelating agent (the concentration of the unchelated rare earth metals then being negligible), a new separation factor  $F_{\text{RE}_B/\text{RE}_A}^*$  can be defined:

$$F_{\text{RE}_B/\text{RE}_A}^* = F \cdot \frac{K_B}{K_A}$$

Separation can therefore be much improved by using a chelating agent whose equilibrium constants  $K_A$  and  $K_B$  are very different from each other.

Certain carboxylic acids form 1:1 chelates over a large pH range with  $K$  values that differ considerably for neighboring rare earth elements and which are sufficiently soluble in water. Citric acid is only of historical interest; it was used in the Ames Laboratory to prepare rare earth oxides in kilogram quantities with a purity of 99.9% in 1947.

Later, polycarboxylic acids were replaced by aminocarboxylic acids, which form chelates with considerably improved stability, selectivity, and solubility.

Figure 44.7 shows the  $K$  values as a function of the atomic numbers of the rare earth elements. They vary between  $10^{10}$  and  $10^{20}$ . The selectivity  $F_L$  also varies widely, and can have values of between 1 and 10 for neighboring elements. For ethylenediaminetetraacetic acid (EDTA) and 1,2-diaminocyclohexanetetraacetic acid (DCTA), the selectivity for the cerium

earths is much higher than for the yttrium earths. The position of yttrium (dashed lines) varies with the chelating agent over a range from Pr to Dy.

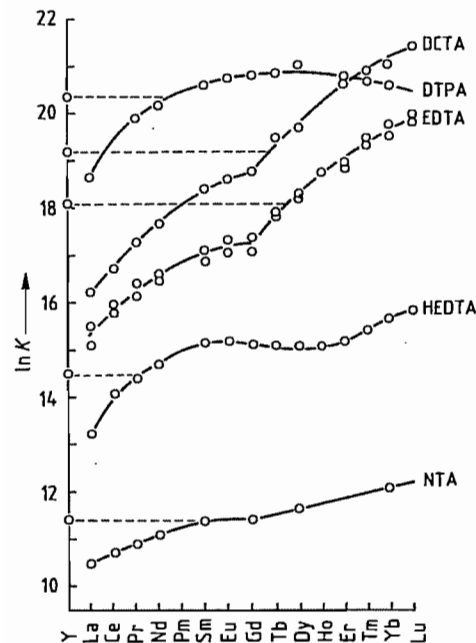

Figure 44.7: Stability constants  $K$  of selected rare earth chelates. ——— Position of yttrium.

The disadvantage of using chelates is their lower solubility. The most soluble chelates such as those of *N*-(hydroxyethyl)ethylenediaminetriacetic acid (HEDTA) or diethylenetriaminepentaacetic acid (DTPA) reach concentrations of ca.  $(2-2.5) \times 10^{-2}$  mol/L at 25 °C.

#### 44.6.3.2 Separation Process

The ion exchange resin is initially loaded with  $\text{NH}_4^+$ . A solution of the salts of the rare earth elements to be separated is then passed through the column. The cations are absorbed by ion exchange onto the upper part of the column. The column is developed with a solution of the chelating agent, e.g., the triammonium salt of ethylenediaminetetraacetic acid.

In partition elution, the rare earth elements that form the most stable chelates are eluted first. The zones of the various rare earth ele-

ments are clearly separated from one other, but the eluted solutions are very dilute. This process is therefore used only for analytical purposes.

In displacement elution, a preliminary charge of a foreign ion (the so-called retarding ion) precedes the band of rare earth elements. This ion (denoted by  $\text{R}^{Y+}$ ) has a lower affinity for the exchange resin than the rare earth elements. Displacement is now carried out using an ion that has a greater affinity for the resin than the rare earth elements. In some circumstances this ion can be  $\text{NH}_4^+$ . The sequence of affinities for the resin is then given by  $\text{NH}_4^+ > \text{RE}_B > \text{RE}_A > \text{R}^{Y+}$ .  $\text{NH}_4^+$  displaces the  $\text{RE}_B$  ions almost quantitatively, while the  $\text{RE}_A$  ions displace the  $\text{R}^{Y+}$  ions. A band of constant length containing the rare earth elements moves through the column, and the concentration of the rare earth elements in the band remains constant. Between the zone containing pure  $\text{RE}_A$  and the zone containing pure  $\text{RE}_B$  there is a narrow zone containing both  $\text{RE}_A$  and  $\text{RE}_B$ .

By this method, more highly concentrated solutions of separated rare earth elements can be obtained than with partition elution. The same amount of resin can therefore be used to produce considerably larger quantities of rare earth elements.

The theory of displacement elution is described in [53]. SPEDDING and coworkers [54] have shown that, if the separation factor  $F_L$  is large enough, the band requires only a minimum movement  $\vartheta$  along the column to achieve a constant equilibrium state. This relationship can be described as follows:

$$\vartheta = \frac{1 + (F_L + 1)x_i}{F_L - 1}$$

where  $x_i$  denotes the mole fraction of the rare earth element in the original mixture that has the lowest affinity for the resin and, therefore, the greatest chelating ability. If  $x_i = 0.5$  (equimolar mixture of two rare earth elements) and  $F_L = 2$ , the band must be moved along the column only 1.5 times its length to achieve equilibrium.

The cations in the equilibrium follow a logarithmic law. The molar fraction  $x_A$  of rare

earth element A is a function of the number of theoretical plates  $n$  required to establish equilibrium:

$$x_A = \frac{F_L^{2n}}{1 + F_L^{2n}}$$

A refinement of the ion exchange model is given in [55, 56]. However, the equations given above are generally adequate for calculating the separation of the rare earth elements.

The main difficulty is the extrapolation from laboratory investigations to the industrial scale. The height equivalent to a theoretical plate (HETP) often becomes much greater.

**Selection of Retarding Ions.** The chelating ability of the weak aminopolycarboxylic acids increases with increasing pH. The  $\text{H}^+$  ions can function as retarding ions:

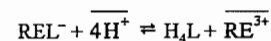

where  $\text{REL}^-$  denotes the dissolved ionic chelate of the rare earth metal. Owing to their low solubility, the acids tend to crystallize in the column. Only DTPA and HEDTA are sufficiently soluble at normal temperatures to enable  $\text{H}^+$  to be used as the retarding ion for the separation of rare earth elements. EDTA can be used at 95 °C [57].

Many cations, e.g.,  $\text{Fe}^{3+}$ ,  $\text{Cu}^{2+}$ ,  $\text{Ni}^{2+}$ ,  $\text{Zn}^{2+}$ , and  $\text{Pb}^{2+}$  have been investigated as possible retarding ions [58]. Of these,  $\text{Cu}^{2+}$  has been most widely used.

#### 44.6.3.3 Industrial Processes

Ion exchange was first used for separating rare earth elements on an industrial scale in the late 1950s. However, it was largely replaced by liquid-liquid extraction during the 1960s, and only used if no suitable liquid-liquid extraction process was known. An example was the production of yttrium oxide [59-62], which, with europium oxide, is important as a red phosphor for TV tubes. However, yttrium oxide is now produced more economically by liquid-liquid extraction.

Since 1970, small amounts of rare earth elements have continued to be separated by ion

exchange [e.g., those required in high purity (> 99.9999%) for some electronic applications] or for the production of rare earth compounds with a very small market and which are only occasionally needed. A new phenol-based ion exchange resin was introduced by Unitika Ltd. of Osaka in 1989. The resin reportedly separates the elements to a purity approaching 99.999999% and at a faster rate than previous resins.

DTPA and HEDTA have proved to be the most suitable chelating agents for the production of high-purity rare earth compounds [63]. One process for producing small amounts of very pure rare earth compounds makes use of the temperature effect, which not only enables much more concentrated solutions of chelating agents to be used, but also enables the separation factor to be modified [64, 65].

#### 44.6.3.4 Disadvantages of Ion Exchange

Chelating agents are expensive and must be recovered after use, but recovery is difficult and requires a large number of batch operations. Also, the low solubility leads to very dilute solutions of the rare earth elements (2-10 g REO/L), whereas with liquid-liquid extraction 10-50 times more concentrated solutions may be used. These high dilutions lead to bulky equipment and handling losses.

On the laboratory scale, theoretical plate heights of the order of millimeters are often possible. On conversion to the industrial scale, the HETP increases considerably, and can reach 10-20 cm in columns 230 cm high and 63 cm in diameter.

For reasons as yet unexplained, the purifying effect decreases with increasing purity. This effect is less significant if rare earth elements are required with impurity contents of ca. 50 ppm, but it makes it almost impossible to reduce the impurity content to, e.g., 5 ppm.

## 44.6.4 Separation by Liquid-Liquid Extraction

### 44.6.4.1 Theoretical Basis

The liquid-liquid extraction process for the separation of the rare earth elements was discovered by FISCHER et al. who showed that extraction of rare earth metal solutions in hydrochloric acid with an alcohol, ether, or ketone gives separation factors of up to 1.5 [66]. The principles of this separation technique are described in [1, part B2; 67; 68].

In the liquid-liquid extraction process used today, the organic phase usually consists of two or more substances. The active extractant has chelating properties and is mainly responsible for the transfer of the dissolved rare earth elements from the aqueous to the organic phase. In some cases, active extractants can be used neat, but they are usually highly viscous or even solid and must be dissolved in a solvent to ensure good contact between the two phases. Suitable solvents are kerosene and aromatics. Usually, a modifying agent is added to the organic phase to improve the hydrodynamics and sometimes also alter the separation factor.

**Distribution Coefficient and Separation Factor.** The distribution coefficient is the fundamental parameter in liquid-liquid extraction. It is strongly dependent on concentration and is given by:

$$k = \frac{[\text{RE}]_{\text{organic phase}}}{[\text{RE}]_{\text{aqueous phase}}} = \frac{[\overline{\text{RE}}]}{[\text{RE}]}$$

The separation factor for two rare earth elements  $\text{RE}_A$  and  $\text{RE}_B$  is thus

$$\alpha_{\text{RE}_B/\text{RE}_A} = \frac{k_B[\overline{\text{RE}}_B][\text{RE}_A]}{k_A[\overline{\text{RE}}_A][\text{RE}_B]}$$

**Method of Operation.** The flow diagram of a countercurrent extraction plant for the contin-

uous separation of two rare earth elements or two groups of rare earth elements is shown in Figure 44.8 [69]. The mixture of rare earths that is to be separated is fed into an intermediate stage of the liquid-liquid extraction plant operating in countercurrent flow. The extraction medium becomes preferentially charged with the rare earth metals (extract) that form the more stable chelates, while the less stable rare earth chelates remain preferentially in the aqueous phase (raffinate).

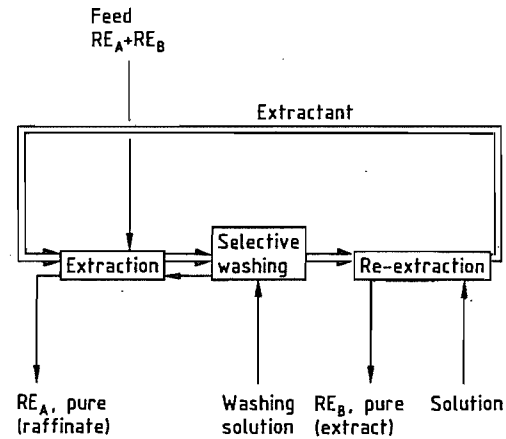

Figure 44.8: Principle of countercurrent liquid-liquid extraction.

This phase flows countercurrent to the extract, leading to further separation and preferential concentration of the more stable rare earth chelates in the extract (selective wash-out). The rare earth metals are re-extracted for further treatment and the extraction medium is treated for re-use. At both ends of the plant, partial recycle takes place. If the recycle was total, separation into individual rare earth elements would take place, but this method is not practical, as it can only be operated batchwise, and a very long time is necessary for the establishment of equilibrium. The separation effect can be calculated by the McCabe-Thiele method in simple cases (Figure 44.9).

Table 44.9: Separation factors with rare earth concentration, nitrate, media, with 50 vol% TBP in Shellsol A [70].

Aqueous phase REO concentration, g/L	Separation factors—yttrium/rare earths							
	Ce/Y	Nd/Y	Sm/Y	Gd/Y	Dy/Y	Ho/Y	Er/Y	Yb/Y
460		0.39	0.88	0.89	1.30	1.20	1.15	0.93
430		0.50		1.14	1.37	1.31	0.85	
310		0.69	1.41	1.51	1.76	1.65	1.35	
220	0.60	1.30	2.02	1.99	2.15	1.91	1.48	0.83
125	0.75	1.77	2.79	2.29	2.10	1.75	1.25	0.83
60		4.08	5.71	4.44	3.96	3.03	2.13	
Separation factors—adjacent rare earth elements								
	Sm/Nd	Gd/Sm	Dy/Gd	Ho/Dy	Er/Ho	Yb/Er		
460	2.26	1.01	1.45	0.92	0.96	0.81		
430			1.20	0.96	0.65			
310	2.04	1.07	1.17	0.94	0.82			
220	1.55	0.99	1.08	0.89	0.78			
125	1.58	0.82	0.92	0.83	0.72			
60	1.40	0.18	0.89	0.77	0.70	0.63		

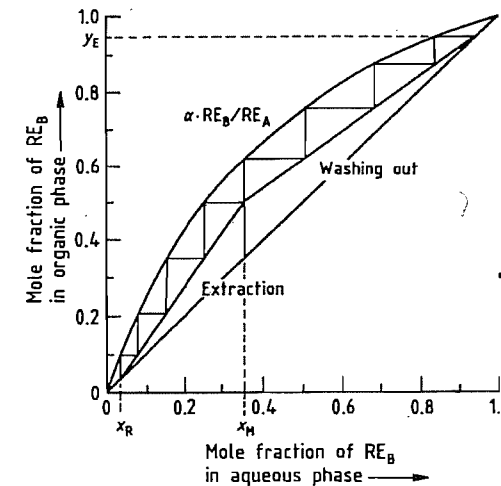
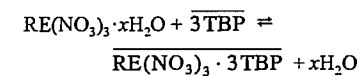

Figure 44.9: Mole fraction  $\text{RE}_B$  in the aqueous phase.

### 44.6.4.2 Extractants

#### Neutral Extractants

The most effective extractant tri-*n*-butyl phosphate (TBP), with which the nitrates of the rare earths are usually extracted by the following generalized process:



Separation factors between various rare earths and between the rare earths and yttrium are listed in Table 44.9 [70].

Concentrated nitric acid improves the selectivity. However, the strong acid solutions are difficult to handle, and the solubility of the rare earth nitrates in these is low. Furthermore, hydrolysis of the solvent takes place. A similar effect to that obtained with nitric acid can be achieved by adding nitrates that are not extracted by TBP, such as  $\text{Al}(\text{NO}_3)_3$ , alkali metal nitrates, or alkaline earth nitrates.

Pure TBP can be loaded with rare earth nitrates up to concentrations of 0.5 mol/L, corresponding to ca. 170–190 g REO/L. Temperature has a relatively small effect. The early development of mathematical models is described in [71]. A review of the many extraction processes with TBP is given in [72, 73]. Other salts of rare earth elements, e.g., perchlorates, chlorides, and thiocyanates have poor distribution coefficients or the selectivities are inadequate. The effect of low temperatures is described in [74].

Sulfoxides,  $\text{RR}'\text{SO}$ , behave analogously to TBP (Figure 44.10) [75]. Alcohols and ethers, which were used in the early days, are no longer of importance.

#### Acidic Extractants

Organophosphoric acids are the second most important extraction media after TBP.



They react with the rare earth elements in what is considered to be a cation-exchange extraction process, e.g., as follows:

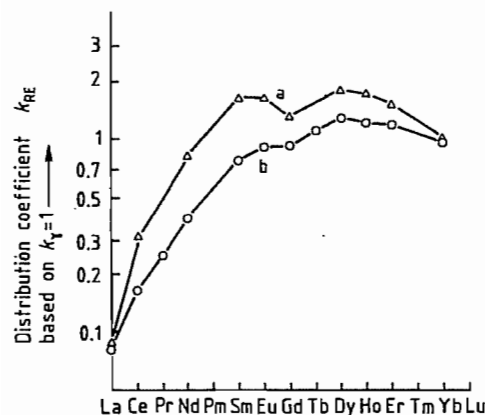
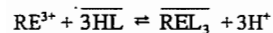
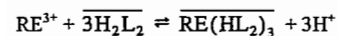
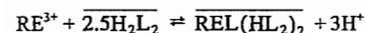

Figure 44.10: Distribution coefficients in the extraction of rare earth nitrates (480 g REO/L): a) TBP with 50% kerosene [75]; b) Di-*n*-heptyl sulfoxide (1 mol/L) in 1,2-dichlorobenzene.

The most fully investigated and most readily available is di-(2-ethylhexyl)phosphoric acid (DEHPA). In the hydrocarbons that are used as diluents, the acid is dimeric. In the case of the rare earth elements, it has been found that the exchange reaction depends on the diluent [76]. In aromatic diluents, the reaction is



In aliphatic diluents it is



The dimeric phosphoric acid is represented by  $\text{H}_2\text{L}_2$ . The distribution coefficient depends on the diluent, decreasing in the following order: kerosene > cyclohexane >  $\text{CCl}_4$  > xylene > benzene. In accordance with the above equations, it is strongly affected by the strength, being inversely proportional to the third power of the concentration of  $\text{H}^+$  ions for low concentrations of the rare earth elements. This effect, which is very important in nitric or hydrochloric acid solution, leads to a mini-

imum value of the distribution coefficient at an acid concentration of 5–6 N [77].

The distribution coefficient increases with increasing atomic number of the rare earth element. Yttrium comes between Ho and Er, in accordance with its ionic radius. DEHPA is a very selective extraction medium, with a separation factor of ca. 2.4 for neighboring elements. The values in  $\text{HClO}_4$  medium are listed in Table 44.10 [79].

Figure 44.11 shows the distribution coefficients as a function of atomic number. The high selectivity of DEHPA is clearly shown. Also, the “tetrad effect” can be seen, shown by a discontinuity after every fourth element. This effect also occurs in other properties of the rare earth elements and is associated with their electronic structure.

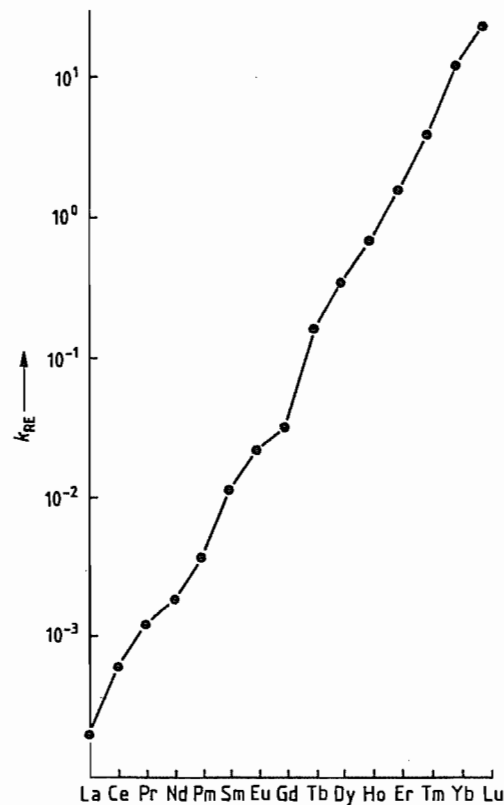

Figure 44.11: Distribution coefficients  $k_{\text{RE}}$  (relative to  $k_{\text{Y}} = 1$ ) in the system DEHPA/perchloric acid [78].

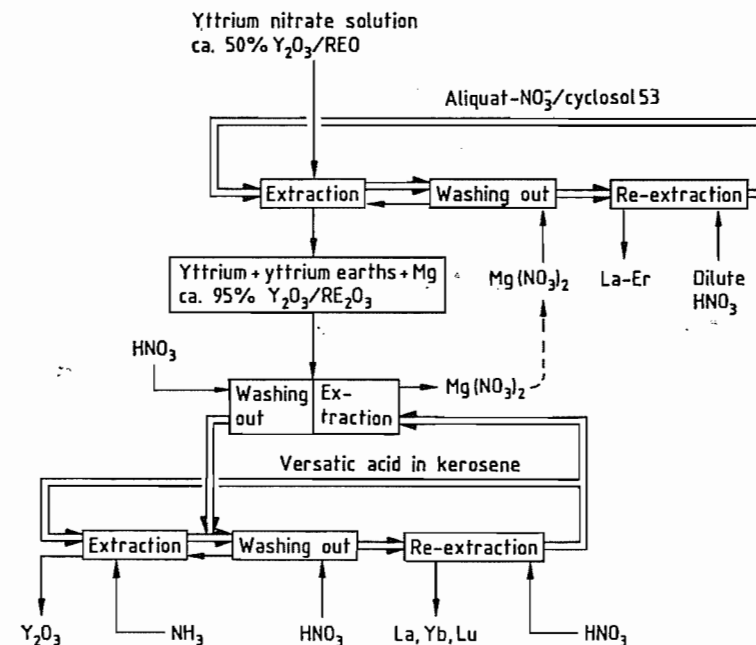

Figure 44.17: Molycorp process for production of pure yttrium oxide [101].

The rare earth metals are produced, both on the laboratory and industrial scale, by molten salt electrolysis and metallothermic reduction [1, part B2; 2, vol 1, chap. 2, 173–232; 5; 6; 103].

#### 44.7.1 Fused-Salt Electrolysis

La, Ce, Pr, Nd, and the mixture of Nd and Pr known as didymium can be produced, like cerium mischmetal, by molten salt electrolysis of a mixture of anhydrous rare earth chlorides and fluorides with alkali and alkaline earth chlorides and fluorides [104].

This process is made possible by the lower melting points of the cerium earth metals, whereas the yttrium earth metals have higher melting points and therefore do not melt during the electrolysis process.

A lower melting point can be achieved by using a cathode (e.g., Cd, Zn) that forms a low-melting alloy with the rare earth metal. This alloy can also have a lower density than the fused salt (e.g., Mg), so that it rises to the surface and can be removed from the fused

salt [105]. The alloying element can then be removed by distillation.

By using molten Cd or Zn as cathode, Sm, Eu, and Yb can also be produced. Under the conditions used for cerium mischmetal, these elements are only reduced to the divalent state.

The production of rare earth metals and their alloys with *3d* metals by molten salt electrolysis of the oxides dissolved in a fluoride melt has been described. The cerium earth metals are particularly suitable due to their low melting points [106].

The reactivity of the rare earth metals causes problems in the choice of construction materials of the electrolysis furnace. High-purity metals can be produced by using molybdenum, tungsten, or tantalum as the crucible and cathode materials. For industrial manufacture, iron crucibles with ceramic or graphite linings are used. If halogens are liberated during the electrolysis, carbon is used as the anode material. Molybdenum is also used in the electrolytic decomposition of the oxides in a fluoride melt.

### 44.7.2 Metallothermic Reduction

Metallothermic reduction of the rare earth oxides and anhydrous rare earth chlorides and fluorides can be used to produce high-purity rare earth metals, especially Gd to Lu, including Y. Metallothermic reduction is also used to produce rare earth mixtures with precisely controlled compositions that cannot be obtained by molten salt electrolysis. Alloys can also be produced by this process.

Alkali metals, alkaline earth metals, and aluminum are suitable reducing agents, as are alloys of these elements with each other. Lithium, which forms low-melting LiF, is of special importance, as is calcium. The use of Mg or Zn has the additional advantage of producing a low-melting alloy with the rare earth metal. The alloying elements can be removed by distillation, yielding the pure rare earth metal.

For the production of La, Ce, Pr, and Nd, the metallothermic reduction of the anhydrous rare earth chlorides is preferred. The reaction is carried out in crucibles lined with MgO at temperatures up to 1100 °C. At higher temperatures, reaction takes place between the rare earth metal and the MgO, and the rare earth chlorides vaporize. The process is not suitable for the production of Sm, Eu and Yb, which are merely reduced to the divalent state.

Gd to Lu and Sc, which have higher melting points, are obtained by reduction of the fluorides with Ca at 1500–1600 °C. The reduction is carried out in tantalum crucibles under a protective gas or in vacuum. The reaction temperature can be reduced by adding a “booster” such as iodine, which gives a slag with good flow properties that separates cleanly from the metal. Praseodymium is produced by reduction of the fluoride with lithium.

The Carlson–Schmidt apparatus is shown in Figure 44.18 [107]. This was used between 1957 and 1959 to produce high-purity yttrium metal in 50 kg batches.

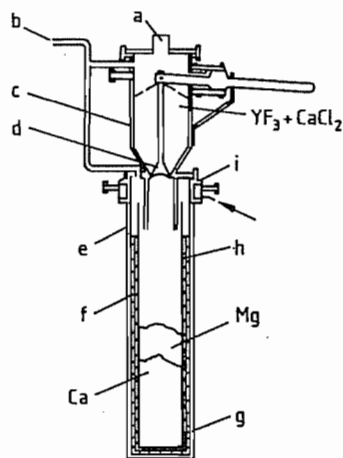

Figure 44.18: Reduction apparatus for the production of yttrium [107]: a) Sight glass; b) Vacuum connection and helium inlet; c) Charging tunnel; d) Charging shut-off mechanism; e) Steel reaction chamber; f) Titanium reaction crucible; g) Graphite insulation; h) Titanium or steel supporting crucible; i) Water cooling.

Sm, Eu, and Yb can be produced by reduction of the oxides with La or the cheaper cerium mischmetal at 1000–1300 °C. The rare earth oxides and the reducing metal are used in the form of pellets, prepared from chippings or thin disks. Sm, Eu, and Yb are volatile at the reaction temperature under vacuum ( $< 10^{-4}$  bar), and can be distilled from the reaction space during the reaction and condensed on coolers. Thus, these metals can be separated from rare earth metals that are not volatile under these conditions and obtained in a pure state. Hence, the starting materials can consist of rare earth oxides in which Sm, Eu, and Yb have merely been concentrated. The principle of the reduction distillation apparatus is illustrated in Figure 44.19 [108]. Further purification can be carried out by a second distillation.

The calciothermic reduction of the rare earth oxides can be carried out such that a metal powder with a defined grain size distribution is produced. In this way, it is possible to produce alloys of rare earth metals with 3d metals that can be used to manufacture permanent magnets.

Methods of producing such alloys include, e.g., the coreduction process carried out under vacuum at 1000 °C for 3 h [109]:

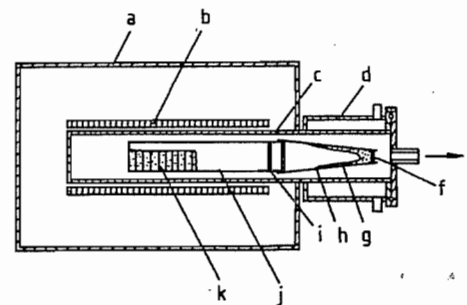
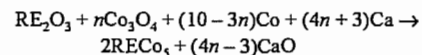
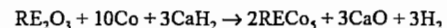

Figure 44.19: Reduction-distillation apparatus for the production of samarium, europium, and ytterbium [108]: a) Furnace; b) Heating element; c) Stainless steel container; d) Water cooling; e) Vacuum; f) Baffle; g) RE metal; h) Molybdenum condenser; i) Heat shield; j) Molybdenum crucible; k) Pelletized reactants.



where  $n = 0-10/3$ , or the reduction diffusion process carried out at 850–1150 °C for 5 h [110]:



The CaO formed can be removed without affecting the properties of the metal powder.

If C and Si are used as reducing agents, rare earth carbides or silicides are formed. Prealloys or inoculation alloys containing rare earth metals are produced by reducing rare earth oxide mixtures or rare earth ore concentrates with CaSi or FeSi in an electric arc furnace.

### 44.7.3 Purification

Production of the pure rare earth metals necessitates the removal of products of the reaction of the metals with the atmosphere, crucible materials, and coreactants. Suitable methods include melting under a protective gas or in a vacuum.

The high-boiling rare earth metals can also be purified by distillation. Tungsten powder is added to bind interstitial impurities (mainly C, N, O) as involatile compounds. Table 44.12 lists the temperatures at which the rare earth metals have vapor pressures of  $1.3 \times 10^{-3}$  to  $1.3 \times 10^{-5}$  bar [111].

Alloying elements and impurities such as Mg, Cd, Zn, and Ca are distilled off under vacuum. The remaining rare earth metal is then in

the form of a sponge, which can be consolidated by fusion in an electric arc furnace.

Zone melting, melt extraction, and melt filtration, e.g., through tungsten powder, degassing in a high vacuum, etc., are other recommended purification methods.

Table 44.12: Vapor pressure and distillation rate of the rare earth metals [111].

RE element	Temperature, °C		Distillation rate at $1.3 \times 10^{-3}$ bär, $\text{gcm}^{-2}\text{h}^{-1}$
	$1.3 \times 10^{-5}$ bar	$1.3 \times 10^{-3}$ bar	
Sc	1397	1773	33
Y	1637	2082	43
La	1754	2217	53
Ce	1744	2174	53
Pr	1523	1968	56
Nd	1341	1759	60
Sm	722	964	83
Eu	613	837	90
Gd	1583	2022	59
Tb	1524	1939	60
Dy	1121	1439	71
Ho	1179	1526	69
Er	1271	1609	68
Tm	850	1095	83
Yb	471	651	108
Lu	1657	2098	61

## 44.8 Analysis

Analytical methods for the determination of the rare earth elements are reviewed in [5, pp. 570–593; 112]. Modern analytical methods are reported in [2, vol. 4; 113, 114].

Analysis may be divided into determination of individual rare earth elements, and group determination, in which the rare earth elements are coprecipitated as oxalates, hydroxides, or carbonates, and are then determined quantitatively after calcination to give the oxides. Complexometric titrations are also used for group analysis.

The ready conversion of cerium to the tetravalent state and of europium to the divalent state offer simple methods of titration for the single elements.

The determination of individual colored rare earth ions is normally carried out by spectrophotometry, emission spectroscopy, and spectroscopy in flames. Emission, absorption, or fluorescence methods are used. The tech-

nique and application of laser source mass spectrometry is discussed in [115].

X-ray fluorescence analysis can be used to determine concentrations in the range between 90% and ppm quantities with moderate sensitivity. It is useful to concentrate the rare earth elements (sometimes with the aid of a trace collector), and to determine the individual rare earth metals in the separated oxide, since a direct determination on the matrix can lead to erroneous results due to the presence of foreign elements or to the physical or chemical condition of the sample. For the determination of yttrium, the K lines are preferably used, although the L lines are preferred for the other rare earths due to the disturbance of the K lines by bremsstrahlung spectra. Inner standards such as strontium or zirconium with yttrium are used, or standard samples that should be as similar as possible to the sample being tested. The spectra can then be used for quantitative determinations. The samples are prepared by compressing the material for analysis with borax.

## 44.9 Compounds

### 44.9.1 Hydrides [2, vol. 3, chap. 26, pp. 299–336]

All the rare earth metals react with molecular hydrogen to form the dihydrides,  $REH_2$ . Most rare earth metals will also react with hydrogen to produce the trihydrides,  $REH_3$ . The rate of reaction depends on temperature, hydrogen pressure, and the surface condition of the metal. Both forms of the hydride are nonstoichiometric, showing wide ranges of homogeneity. The dihydrides of La, Ce, Pr, and Nd have ranges of homogeneity with a composition approaching  $REH_3$ . The dihydrides of Sm, Gd to Tm, Lu, and Y have narrower ranges of existence and form a trihydride phase that is also nonstoichiometric.  $SrH_2$ ,  $EuH_2$ , and  $YbH_2$  are almost stoichiometric, but  $YbH_2$  takes up additional hydrogen at very high pressures, up to the composition  $YbH_{2.55}$ . With the exception of  $EuH_2$  and  $YbH_2$ , which

form orthorhombic crystal structures similar to the alkaline earth hydrides, the dihydrides are cubic (fluorite structure). The trihydrides crystallize with a hexagonal structure.

Rare earth hydrides are brittle compounds, sometimes with a metallic luster. Similar to the transition metal hydrides, the rare earth dihydrides (except for  $YH_2$  and  $EH_2$ ) are metallic conductors. In particular, hydrogen-deficient dihydrides are better electronic conductors than their parent metals. In general, as the trihydride composition is approached the materials begin to show semiconducting properties.

Hydrides formed by the hydrogenation of binary rare earth solid solution alloys are usually considered to be solid solutions of the two parent rare earth hydrides, and as such their properties can be predicted with reasonable confidence from those of the constituent hydrides. In the case of binary alloys  $REM$ , where  $M$  is a non-rare-earth metal, the properties of the intermetallic hydride formed by hydrogenation of the alloy bear no relationship to those of the parent hydrides. They are therefore generally viewed as pseudobinary metal hydrides. Some of these materials can reversibly and efficiently absorb and desorb considerable amounts of hydrogen, and are therefore of commercial interest as a means of storing hydrogen. A review of hydrogen absorption in intermetallic compounds is provided in [116].

### 44.9.2 Oxides, Hydroxides, Peroxides, Salts of Inorganic Oxoacids, Double Salts

Aspects of the transformation and defect structures in rare earth sesquioxides is provided in detail in [117]. The sesquioxides,  $RE_2O_3$ , of the rare earth elements, with the exception of Ce, Pr, and Tb, are obtained by oxidation of the metals with oxygen at elevated temperatures or by thermal or pyrohydrolytic decomposition of the hydroxides, halides, and certain oxosalts. In the case of Ce, Pr, and Tb, similar conditions yield the compounds  $CeO_2$ ,  $Pr_6O_{11}$ , and  $Tb_4O_7$ , which can be reduced to

the sesquioxides by hydrogen at elevated temperature. The sesquioxides melt at very high temperatures (in the range of 2200–2400 °C) and have very high enthalpies of formation [–1907.9 kJ/mol ( $Sc_2O_3$ ) to –1661 kJ/mol ( $Eu_2O_3$ )].

They crystallize in the hexagonal system (type A), monoclinic system (type B) or cubic system (type C), depending on the temperature and the radius of the cation. At temperatures near the melting point, high-temperature modifications, types H and X, are also formed. Most sesquioxides are polymorphic, not including the two high-temperature forms.  $La_2O_3$  forms type A crystals;  $Ce_2O_3$  to  $Nd_2O_3$  form types A and C;  $Sm_2O_3$  to  $Ho_2O_3$  form types C and B; and  $Er_2O_3$  to  $Lu_2O_3$ ,  $Y_2O_3$ , and  $Sc_2O_3$  form only type C crystals. Whether the observed modifications are thermodynamically stable or metastable has so far been established in only a few cases.

Cubic crystals (fluorite type) are formed both by the dioxides of Ce, Pr, and Tb and by their intermediate oxides, in which cations in the two oxidation states 3+ and 4+ are present together. With the exception of  $CeO_2$ , which can be produced by air oxidation, the dioxides can only be obtained under strongly oxidizing conditions (e.g., oxygen at high pressure). The nonstoichiometric intermediate oxides have been extensively investigated in the system  $Pr-O$  [118]. Here, phases exist that are members of a series with the general composition  $Pr_nO_{2n-2}$  ( $n = 7, 9, 10, 11, 12$ ).

The compound  $EuO$  is fairly easy to obtain by reduction of  $Eu_2O_3$ , e.g., with  $EuH_2$  or  $Eu_{(g)}$ . With this exception, the condensed monoxides of the rare earth elements have only been observed as metastable compounds or as compounds stable under extreme conditions such as high pressure. For example, gaseous monoxides of all the rare earth elements have been observed at very high temperatures.  $EuO$  is a violet-black, cubic (NaCl type), ferromagnetic substance ( $T_c = 70$  K).  $Eu$  also forms the oxide  $Eu_3O_4$ , in which both  $Eu^{2+}$  and  $Eu^{3+}$  ions are present.

The hydroxides,  $RE(OH)_3$ , are obtained as hydrates by the precipitation of  $RE^{3+}$  ions with

ammonia or other bases. The hydroxides and oxide hydroxides,  $REOOH$ , can be prepared in crystalline form by hydrothermal synthesis. The hydroxides are sparingly soluble in water. Their basicity and solubility decrease with increasing atomic number. This progressive change in properties is important both for the separation of the rare earth elements from one other (see Section 44.6) and for chemical analysis. The hydroxides react with carbon dioxide to form basic carbonates, the rate of reaction depending on their basicity.

So far, very little is known of the existence of peroxides of the rare earth elements. Cerium peroxide forms as a deep brown, hydrated compound when  $Ce^{3+}$  ions are precipitated with ammonia and hydrogen peroxide. This intense colour can be used for the detection of Ce in the presence of other rare earth elements.

Of the group of compounds of rare earths with inorganic oxoacids, the carbonates, sulfates, nitrates, and certain double salts are of importance for analytical and preparative chemistry. Precipitation of  $RE^{3+}$  ions by solutions of alkali metal carbonates yields the sparingly soluble hydrated or basic carbonates. These are readily decomposed by acids or on heating, liberating  $CO_2$ . Apart from lanthanum sulfate, which forms a nonhydrate, the sulfates crystallize from aqueous solution as octahydrates. The hydrated sulfates can be thermally decomposed to the anhydrous form. They are fairly soluble, having a negative temperature coefficient of solubility, and are of industrial importance since sulfuric acid is used for digesting certain rare earth ores. Double sulfates, e.g., salts of the type  $RE_2(SO_4)_3 \cdot Na_2SO_4 \cdot nH_2O$  are important in the separation of the cerium earths from the yttrium earths.

The rare earth nitrates crystallize from solution in dilute nitric acid in the form of hydrates,  $RE(NO_3)_3 \cdot nH_2O$  ( $n \leq 6$ ). These salts are very soluble in water and moderately soluble in various organic solvents (alcohols, ketones, esters), and are important in the separation of the rare earth elements from each other by liquid-liquid extraction. Certain double nitrates, e.g., of the type  $2RE(NO_3)_3 \cdot$

$3\text{Mg}(\text{NO}_3)_2 \cdot 24\text{H}_2\text{O}$  were at one time important in the separation of the rare earth elements by fractional crystallization. A comprehensive review of inorganic complex compounds is provided in [119, 120].

#### 44.9.3 Halides

The rare earth elements, except for europium, form trihalides,  $\text{REX}_3$ , where  $X = \text{F}, \text{Cl}, \text{Br}, \text{I}$ . The trifluorides are sparingly soluble and are obtained from aqueous solution by precipitation with hydrogen fluoride. If these precipitates are dried at elevated temperatures, partial hydrolysis takes place, particularly of the more weakly basic elements. This can be effectively prevented by adding an excess of  $\text{NH}_4\text{F}$  or  $\text{HF}_{(g)}$  during the dehydration process. With the exception of  $\text{ScF}_3$ , the trifluorides crystallize in the hexagonal  $\text{LaF}_3$  structure ("tysonite structure") or the orthorhombic  $\text{YF}_3$  structure, depending on the radius of the cation and the temperature range.  $\text{ScF}_3$  crystallizes in the cubic system ( $\text{REO}_3$  type). When dimorphism occurs, the  $\text{YF}_3$  type is the low-temperature, and the  $\text{LaF}_3$  type, the high-temperature modification. The trifluorides are high-melting compounds [1140 °C ( $\text{HoF}_3$ ) to 1552 °C ( $\text{ScF}_3$ )].  $\text{EuF}_3$  and, to a very limited extent,  $\text{YbF}_3$ , tend to liberate fluorine at high temperatures. A review of the rare earth fluorides is given in [117].

The trichlorides can be obtained as their hexa- or heptahydrates by careful evaporation of their solutions in hydrochloric acid. The dehydration of the hydrates must be carried out in a stream of  $\text{HCl}$  and/or in the presence of an excess of  $\text{NH}_4\text{Cl}$  to prevent hydrolysis. On an industrial scale, the anhydrous trichlorides are obtained by reacting oxidic ores with chlorine and carbon. They crystallize in the hexagonal  $\text{UCl}_3$  type structure ( $\text{LaCl}_3$  to  $\text{GdCl}_3$ ) or the monoclinic  $\text{YCl}_3$  type structure ( $\text{DyCl}_3$  to  $\text{LuCl}_3$ ,  $\text{YCl}_3$ ,  $\text{ScCl}_3$ ). They are very soluble in water and in certain organic solvents such as ethanol and pyridine. Their melting points are in the range 588 ( $\text{TbCl}_3$ ) to 892 °C ( $\text{LuCl}_3$ ). With the exceptions of  $\text{EuCl}_3$  and  $\text{YbCl}_3$ , which decompose on heating with liberation

of chlorine, all the other rare earth chlorides vaporize without decomposition or sublime ( $\text{ScCl}_3$ ).

The tribromides and triiodides are obtained in the same way as the trichlorides. The tribromides, and more so the triiodides of  $\text{Eu}$ ,  $\text{Yb}$ , and  $\text{Sm}$ , have a marked tendency to lose halogen on heating, since the 2+ oxidation state of the cation becomes more stable with increasing size of the anion. The melting points of the tribromides are in the range 664 ( $\text{SmBr}_3$ ) to 960 °C ( $\text{LuBr}_3$ ), and those of the triiodides in the range 738 ( $\text{PrI}_3$ ) to 1045 °C ( $\text{LuI}_3$ ). The trihalides react with the sesquioxides to form oxide halides of various compositions.

The existence of tetrahalides is limited to the tetrafluorides of  $\text{Ce}$ ,  $\text{Pr}$ , and  $\text{Tb}$ .  $\text{CeF}_4$  and  $\text{TbF}_4$  are obtained by the reaction of the elements or the trifluorides with fluorine.  $\text{PrF}_4$  can only be obtained by the extractive removal of  $\text{NaF}$  from the readily prepared  $\text{Na}_2\text{PrF}_6$  by treating it with liquid hydrogen fluoride in a fluorine atmosphere. The tetrafluorides are white solids which crystallize in the monoclinic system ( $\text{UF}_4$  or  $\text{ThF}_4$  type). They are slightly soluble in water but decompose to the trifluorides and are thermally unstable. Cerium tetrafluoride is appreciably more stable than the tetrafluorides of praseodymium and terbium.

The dihalides may be divided into two groups: the mainly salt-like compounds, in which the cation has a valency of 2+, and those compounds whose properties (e.g., electrical conductivity) indicate that the bond has some metallic character, and can be represented, in a much simplified way, by the general formula  $\text{Ln}^{3+}(\text{e}^-)\text{X}_2$ . Important methods of preparation include reduction of the trihalides by hydrogen at elevated temperatures (dichlorides, dibromides, and diiodides of  $\text{Eu}$ ,  $\text{Yb}$ , and  $\text{Sm}$ , as well as  $\text{EuF}_2$ ), or by solid or gaseous rare earth metals.

Thermodynamically stable difluorides are known only for  $\text{Eu}$ ,  $\text{Sm}$ , and  $\text{Yb}$ . However, the difluorides of almost all the other rare earth elements can be prepared as metastable compounds which crystallize in the cubic system (fluorite type).  $\text{EuF}_2$ ,  $\text{YbF}_2$ , and  $\text{SmF}_2$  can take

up considerable quantities of the corresponding trifluorides in solid solution. Other dihalides of many rare earth elements can be prepared, but it is difficult to give definite trends for the occurrence of salt-like or metallic properties. However, it can be stated that all the dihalides of  $\text{Sm}$ ,  $\text{Eu}$ , and  $\text{Yb}$  are of a mainly salt-like nature.

#### 44.9.4 Chalcogenides

The rare earth elements form chalcogenides with the general formula  $\text{REZ}$ ,  $\text{RE}_3\text{Z}_4$ ,  $\text{RE}_2\text{Z}_3$  ( $\text{RE}_5\text{Z}_7$ ), and  $\text{RE}_2\text{Z}_4$  (where  $Z = \text{S}$  or  $\text{Se}$ ) [3, vol. 3, pp. 149–248; 121]. With  $\text{Te}$ , compounds are known with the formulae  $\text{RETe}$ ,  $\text{RE}_3\text{Te}_4$ ,  $\text{RE}_2\text{Te}_3$ ,  $\text{RE}_4\text{Te}_7$ ,  $\text{RETe}_2$ ,  $\text{RE}_2\text{Te}_5$ , and  $\text{RETe}_3$ , of which some must be regarded as intermetallic compounds. The rare earth chalcogenides exhibit a wide range of structural, electrical, and magnetic properties. Most of them are very sensitive to hydrolysis and can therefore only be prepared and handled if moisture is excluded.

The monochalcogenides are mainly prepared by direct synthesis from the elements, but may also be prepared in some cases ( $\text{YbS}$ ,  $\text{YbSe}$ ,  $\text{SmS}$ ,  $\text{SmSe}$  [20, 122]) by the reduction of higher chalcogenides with the corresponding gaseous rare earth metal.  $\text{EuS}$  and  $\text{EuSe}$  are also obtained by the reaction of  $\text{Eu}_2\text{O}_3$  with  $\text{H}_2\text{S}/\text{H}_2$  or  $\text{H}_2\text{Se}/\text{H}_2$  at ca 1100 °C. All the rare earth monochalcogenides crystallize in the cubic system ( $\text{NaCl}$  type) and have high melting and boiling points. Thus, for example, the compound  $\text{CeS}$  has been recommended as a sulfide ceramic material for coating vessels due to its inertness to many metals [123]. It begins to liquefy above 2100 °C, and melts at 2450 °C. Despite the 1:1 stoichiometry, only the monochalcogenides of  $\text{Eu}$ ,  $\text{Yb}$ , and  $\text{Sm}$  can (within limits) be regarded as compounds of  $\text{RE}^{2+}$ . The other compounds have properties that show the simultaneous presence of ionic and metallic bonding.

The sesquichalcogenides,  $\text{RE}_2\text{Z}_3$  ( $Z = \text{S}, \text{Se}, \text{or Te}$ ), can also be prepared by direct synthesis from the elements (the only practical method for the tellurides), or by reaction of the sesqui-

oxides or trihalides with the hydrogen chalcogenides at high temperatures. When the oxides are used, very stable oxide chalcogenides such as  $\text{RE}_2\text{O}_2\text{Z}$  can be produced as intermediate products. The sesquichalcogenides can exist in several modifications. The cubic modification is nonstoichiometric, with the approximate composition  $\text{RE}_3\text{Z}_4$  ( $\text{Th}_3\text{P}_4$  type).

Rare earth polychalcogenides include the polysulfides  $\text{RE}_2\text{S}_4$ . With the exceptions of the polysulfides of  $\text{Tm}$  and  $\text{Lu}$ , they are obtained by heating the sesquisulfides with an excess of sulfur. They are interesting in that they are not  $\text{RE}^{4+}$  compounds, but contain two  $\text{S}^{2-}$  ions and one  $\text{S}_2$  group per formula unit.

The crystal chemistry and phase equilibria of rare earth ternary systems with chalcogen elements is dealt with in [124].

#### 44.9.5 Nitrides

The rare earth elements react with nitrogen to give nitrides of the type  $\text{REN}$  [125], and with the elements  $\text{P}$ ,  $\text{As}$ ,  $\text{Sb}$ , and  $\text{Bi}$  to give compounds with other stoichiometric compositions. The nitrides are formed in slow reactions of nitrogen with the metals or hydrides in very finely divided form at ca 1000 °C, or more readily by reaction with ammonia at ca. 700 °C. The nitrides are cubic ( $\text{NaCl}$  type) and have very high melting points and decomposition temperatures. They have a metallic appearance when in a compact form, and are ionic compounds with metallic conductivity or semiconductors. Apart from  $\text{ScN}$ , all the rare earth nitrides are very sensitive to hydrolysis, and can therefore only be handled when moisture is excluded.

#### 44.9.6 Carbides

Of the rare earth compounds with elements of group 14, only the carbides are described here. Compounds with the formulae  $\text{REC}_2$ ,  $\text{RE}_2\text{C}_3$ ,  $\text{RE}_2\text{C}$ , and  $\text{REC}_{1-x}$  are known. Of these, the carbides  $\text{REC}_2$  represent the largest group [3, vol. 3, pp. 284–342]. The carbides can be synthesized directly from the elements. The high-melting dicarbides are highly invol-

atile, crystallize in the tetragonal system (CaC<sub>2</sub> type), and are metallic conductors with approximately one conducting electron per C<sub>2</sub> group. Hydrolysis of the carbides under neutral or weakly acidic conditions leads to complex mixtures of unsaturated and saturated hydrocarbons, most of which are C<sub>2</sub> hydrocarbons due to the presence of C<sub>2</sub> groups in the crystal structure.

#### 44.9.7 Complexes; Organic Compounds

From the point of view of complex-forming properties, the rare earth elements resemble the elements of group 2 more closely than those of the 3*d* transition elements, owing to the peculiarities described earlier. Only very strong ligands, with strong chelate-forming properties, are able to form thermodynamically stable, isolable rare earth complexes.

Many rare earth chelates are very difficult to isolate from aqueous solution, as water is an extremely strong ligand for rare earth ions. Also, ligand exchange reactions take place very rapidly in solution, which makes it impossible to isolate definite isomers. Of the rare earth chelate compounds so far prepared (e.g., [3, vol. 3, pp. 61–128; 126]), those useful for liquid–liquid extraction and separation of rare earth elements are of particular interest. The technically important chelating agents include certain ketones, but, above all, tri-*n*-butylphosphate (TBP) [3, vol. 1, pp. 89–109]. The chelates of the rare earth elements with 2,4-pentanedione (acetylacetone) and its derivatives are also important, these being characterized by great stability and sometimes considerable volatility [127].

When considering organic compounds [1, part D1–D3; 128], a distinction should be made between true organometallic compounds and salts of organic acids or coordination compounds with organic ligands. The relatively small number of true organic compounds (e.g., the tris(cyclopentadienyl) derivatives [129] and the triphenylene and anionic tetraphenyl complexes [130, 131]) are mostly very reactive, sensitive substances. Of the

large group of salts of organic acids, the oxalates deserve mention. These are formed as sparingly soluble precipitates from solutions in moderately concentrated hydrochloric acid and are important for the purification of the rare earth elements, and also for their quantitative determination. Organometallic compounds of the rare earth elements are discussed in [132].

#### 44.10 Uses [3, vol. 1, pp. 416–500; vol. 2, pp. 190–297]

The rare earth metals and their compounds are used in numerous areas of industry for a wide range of purposes. The most important of these include metallurgy, catalysts in the chemical industry, coloring of glass and ceramics, the production of magnets, and phosphors.

**Metallurgy.** The importance of the rare earth metals in metallurgy is highlighted in [133, 134]. In 1990, ca. 22% by volume of rare earth consumption in the United States was devoted to metallurgical end use. The equivalent volume usage in Japan by contrast was ca. 10%. One of the most important areas of application, is based on their reactivity with water, hydrogen, nitrogen, sulfur, and the so-called tramp elements such as arsenic, antimony, and bismuth. Sulfur reacts to form rare earth sulfides or oxysulfides in spheroidal form which are not deformed under rolling conditions, and which form solid particles at the temperature of molten steel, thus improving the hot formability and flexibility of microalloyed steels, and reducing anisotropy in the notched toughness test. Rare earths are used in the form of mischmetal containing principally Ce, La, and Nd.

The addition of rare earth metals such as yttrium and cerium, or cerium mischmetal imparts improved oxidation resistance to heating element alloys, to substrate alloys for catalysts, and to superalloys. Rare earth metals improve the precipitation of spheroidal graphite in SG iron casting. Although for economic reasons cerium mischmetal is more often used

in these applications than the pure rare earth metals, the pure metals can give better results when used separately.

Addition of rare earths to copper and aluminum alloys, used as electrical conductors, improves the mechanical properties. In China, an yttrium magnesium aluminum alloy has been developed for transmission cabling. Yttrium improves tensile strength, heat resistance, vibration resistance and can raise electrical conductivity by 50%. Creep resistance and tensile strength at high temperatures are improved by addition of rare earth metal (mainly neodymium, praseodymium, and yttrium) to magnesium alloys for pressure casting and aircraft construction. Recent investigations have shown significant improvements to high strength Al–Mg and Al–Li alloys by the addition of scandium. Similar effects can be achieved with titanium and titanium alloys, and with alloys of niobium, tantalum, and vanadium.

The rare earth metals react readily with gaseous elements, and are therefore used as getters. Their pyrophoric properties are utilized in friction igniters (“flints”) and in military projectiles.

Alloys of the type LaNi<sub>5</sub> are capable of absorbing hydrogen, even from mixtures with other gases, forming rare earth hydrides. These are used to store hydrogen reversibly. In these alloys La can be partially replaced by Ce, Pr, and Nd, and Ni by Co, Cr, Cu, Fe, or Mn. They can also be used to separate D<sub>2</sub> from H<sub>2</sub> [135–138].

Rare earth alloys with 3*d* transition elements have magnetic properties [2, vols. 14, 16; 139, 140]. These alloys are of the type REA<sub>5</sub> or RE<sub>2</sub>A<sub>17</sub>, in which the rare earth metals can be cerium earths, especially Sm, and the 3*d* transition metals can be pure Co, or Co partially replaced by Fe, Mn, Cr, or Cu. These alloys give extremely stable magnets, having energy products, high remanence, and high coercive field strengths [141–143]. Some typical properties are given in Table 44.13. These high-power magnets are used in small motors, printers, quartz watches, headphones, loudspeakers, magnetic storage, traveling-wave tubes, etc., mainly in miniaturized equipment.

Rare earth alloys also exhibit very large magnetostriction at cryogenic temperatures. REFe<sub>2</sub> Laves phase compounds show very large magnetostriction but possess intrinsic magneto-crystalline anisotropy [2, vol 2, chap 15, pp 231–258]. For many applications, high strain is required at low magnetic fields, and therefore anisotropy must be minimized. The most important material to emerge from research activity so far is the ternary alloy Tb<sub>0.27</sub>Dy<sub>0.73</sub>Fe<sub>2</sub>, which shows promise for high power actuators, transducers, and sensors.

**Catalysts** [117, vol 5, chap 43, 217–320]. A further important use for rare earth elements (as their chlorides or nitrates) is in zeolite cracker catalysts for the improvement of gasoline yields and reductions in the formation of coke and light hydrocarbons. These catalyst compositions can correspond either to the natural composition of the cerium earths or can be based mainly on cerium [144].

Table 44.13: Characteristic properties of selected rare earth permanent magnetic materials.

Material	Energy product (BH) <sub>max</sub> , kJ/m <sup>3</sup>	Remanence B <sub>r</sub> , mT	Coercivity before polarisation H <sub>cb</sub> , kA/m	Coercivity after polarisation H <sub>cp</sub> , kA/m
SmCo <sub>5</sub>	160	920	2500	680
(Sm <sub>0.4</sub> Pr <sub>0.6</sub> )Co <sub>5</sub>	200	1050	1200	720
(Sm <sub>0.2</sub> Mn <sub>0.8</sub> )Co <sub>5</sub>	120	800	1000	580
Sm(Co, Cu, Fe) <sub>5</sub>	110	770	300	290
Sm(Co, Cu, Fe, Zr) <sub>6.9</sub>	240	1130	580	540
Sm(Co, Cu, Fe, Zr) <sub>7.5</sub>	210	1080	800	780
NdFeB	300	1300	1000	700
NdDyFeB	250	1100	2000	880

Rare earth elements are also used as catalysts for alkylation, isomerization, hydrogenation, dehydrogenation, dehydration, reforming of hydrocarbons, polymerization, oxidation of CO and hydrocarbons [145, 146], and reduction of the concentration of nitrogen oxides in automobile exhaust gases [147]. The formation of hydrides enables them to be used as methanation catalysts [148]. Cerium stabilizes  $\gamma\text{-Al}_2\text{O}_3$  as a carrier for noble metal catalysts [149, 150]. Rare earth chelates with diketones can replace lead compounds as anti-knock agents [151].

**Energy Production.** Rare earth elements have a possible future use in energy production  $\text{RENi}_5$  [152],  $\text{La}_2\text{O}_3$ ,  $\text{Y}_2\text{O}_3$ , and  $\text{CeO}_2$ , with Ni, Co, Cr, or Zn [153], can be used as electrodes in fuel cells, while the solid electrolyte can be  $\text{ZrO}_2$  stabilized with  $\text{Y}_2\text{O}_3$ ,  $\text{ZrO}_2\text{-Y}_2\text{O}_3\text{-Ta}_2\text{O}_5$ , or  $\text{ZrO}_2\text{-CeO}_2\text{-Y}_2\text{O}_3$  [154, 155].

Water, in the form of a photooxidizable compound with  $\text{Eu}^{2+}$ , is reduced in the first stage, and in the second stage the  $\text{Eu}^{3+}$  formed is reduced by a light-sensitive transition metal complex [156]. Water can be oxidized by  $\text{Ce}^{4+}$  in the presence of the redox catalyst  $\text{PtO}_2$  or  $\text{IrO}_2$ , and the  $\text{Ce}^{3+}$  produced reconverted photochemically to  $\text{Ce}^{4+}$ , with liberation of  $\text{H}_2$  [157]. The low Curie point (20 °C) of Gd can be utilized to produce a heat pump [158].

In magnetohydrodynamic generators,  $\text{LaCrO}_3$  [159] and  $\text{LaCoO}_3$  [160] are used as electrodes, and  $\text{LaB}_6$  [161] as an electron emitter.

**Glass and Ceramics.** Another important use of rare earth elements is in the glass and ceramic industries [162]. Rare earth oxides in their naturally-occurring composition or with an increased  $\text{CeO}_2$  content (or pure  $\text{CeO}_2$ ) are used as polishing agents in the glass industry. Other uses of Ce include the chemical decolorization of glass ( $\text{Fe}^{2+} \rightarrow \text{Fe}^{3+}$ ) [163], reduction of UV transparency of glass containers for foodstuffs and medicines, and the prevention decolorization of television screens by X rays and  $\gamma$  rays.

Nd (blue to wine red), Pr (green), Er (pink), and Ho (blue) can be used both for coloring

glass and for color neutralization. Combinations of these with each other and with other elements such as Ti(+ Ce: yellow), Se(+ Nd: violet), and Ni(+ Nd: reddish) give further effects.

In optical glasses for lenses, La improves the refractive index and dispersion. La and Gd also improve chemical and mechanical properties, and enable these types of glass to be used under the demanding conditions of magneto-optical and electro-optical systems [120, chap. 58, pp. 1–90].

In very pure types of glass,  $\text{Eu}^{2+}$  and  $\text{Ce}^{4+}$  give a phototropic effect in sunlight.

In the ceramic industry, rare earth oxides are used as yellow pigments (Pr) [164], as opacifiers in glazes and enamels (Ce) [165], for radiation-shielding ceramics (Sm, Eu, Gd, Dy) [166], to improve the light fastness of lead chromate and titanium dioxide pigments, to impart "natural" fluorescence to artificial teeth (Eu, Sm, Ce) [167–169], and especially as stabilizers for cubic  $\text{ZrO}_2$  [170]. An interesting application is in so-called lambda probes, in which  $\text{Y}_2\text{O}_3$ -stabilized  $\text{ZrO}_2$  is the solid electrolyte in a measurement/control system that optimizes oxidation and reduces the content of harmful gases in automobile exhausts [171]. In a similar application, it is used for determining the  $\text{O}_2$  content of liquid steel [172].

$\text{CeS}$  and  $\text{Y}_2\text{O}_3$  can be used for the manufacture of crucibles and as temperature-resistant materials for gas turbines [173]. The mechanical properties of  $\text{Si}_3\text{N}_4$  are improved by the addition of rare earths to promote sintering [174].

**Electronics.** Compounds of the type  $\text{Pb}_{1-x}\text{La}_x(\text{Zr}_{1-y}\text{Ti}_y)\text{O}_3$  (PLZT) are used as electro-optical ceramics in displays [175], as electromechanical transducers [176], and for their piezoelectrical properties [177]. Lanthanum doped  $\text{BaTiO}_3$  is used as a dielectric in capacitors [178], and in thermistors [179].

Compounds of the garnet type such as  $\text{Y}_3\text{Al}_5\text{O}_{12}$  (YAG),  $\text{Y}_3\text{Fe}_5\text{O}_{12}$  (YIG), and yttrium orthoaluminate  $\text{YAlO}_3$  (YALO), doped with neodymium, are used as solid state lasers

[2, vol. 4, pp. 275–315]. Solid state Nd–YAG lasers, operating at 1064 nm wavelength, are most popular for cutting, welding and metal heat treatment. In Japan production is growing at ca. 10%/a. Recently, Ho–YAG and Er–YAG lasers, emitting at 2000 nm and 2900 nm, respectively, have been developed to partly replace  $\text{CO}_2$  lasers for use in microsurgery. In 1986 Sumitomo Metal Mining Company produced single crystals of gadolinium–aluminum–scandium garnet (GASG). These laser materials doped with nickel and chromium are expected to capture some of the tunable and high-power laser markets.  $\text{Y}_3\text{Fe}_5\text{O}_{12}$  (YIG) is also used in frequency control applications [180, 181].  $\text{Gd}_3\text{Ga}_5\text{O}_{12}$  (GGG) crystal contains 53.7% gadolinium oxide and is used for bubble type magnetic information storage [182] as well as in the doped form (ca. 3 atom% Nd) for high-power pulsed lasers. Rare earths used in laser technology are of very high purity (> 99.999%) and therefore have high added value.

Rare earth–transition metal alloys deposited onto glass or polycarbonate provide an excellent magneto-optical medium for high density data storage and retrieval. Films are generally deposited by sputtering, and the targets used in the process usually contain terbium, gadolinium, dysprosium, or neodymium together with cobalt and iron and other minor elements. Rare earth halides of Eu and Yb have semiconductor properties [183].

**Phosphors** [2, vol. 4, pp. 237–274]. Stimulation by UV, X rays, or electron beams causes certain rare earth elements to emit light of a definite wavelength. The energy is transferred from the host lattice to an activator. The following can act as host lattices: oxide sulfides and vanadates of Y, La, Gd, and Lu (favorable 4f electron configurations), and borates, aluminates, phosphates, silicates, tungstates, fluorides, compounds of the ruby type, etc. Phosphors containing rare earth oxides are

used in color cathode ray tubes, X-ray intensifying screens, and fluorescent lamps. The following are used as red emitting phosphors in cathode ray tubes for TV and VDU screens:  $\text{YVO}_4:\text{Eu}^{3+}$  (4.5%),  $\text{Y}_2\text{O}_3:\text{Eu}^{3+}$  (3.5%), and  $\text{Y}_2\text{O}_2\text{S}:\text{Eu}^{3+}$  (3.65%). Examples of green-emitting phosphors are  $\text{La}_2\text{O}_2\text{S}:\text{Tb}^{3+}$ ,  $\text{CaS}:\text{Ce}^{3+}$ , and  $\text{SrGa}_2\text{S}_4:\text{Eu}^{2+}$ . Blue phosphors include  $\text{Sr}_5\text{Cl}(\text{PO}_4)_3:\text{Eu}^{2+}$  and  $\text{ZnS}:\text{Tm}^{3+}$ . Other rare earth activators are  $\text{Ce}^{3+}$  (UV, blue),  $\text{Pr}^{3+}$  (red, green, blue, UV),  $\text{Nd}^{3+}$  (IR, lasers),  $\text{Sm}^{3+}$  (orange),  $\text{Eu}^{2+}$  (blue, green),  $\text{Tb}^{3+}$  (green), Dy (yellow, white), Er (green, lasers), Ho (green, yellow, lasers), Tm (blue), and Yb (green). Other areas of use include high-sensitivity X-ray films, optical scanning devices, photocopying equipment, and scintillation crystals [184]. Rare earth fluorides and oxides are still added to the carbon of classical carbon arc lamps, e.g., for cinemas, to improve light emission [185]. In 1991, 73% by volume of the rare earths used in phosphors was associated with yttrium, 5% with europium, 4% with terbium, and 18% with other rare earth elements.

**Reactor Technology.** Sm, Eu, Gd, and Dy have high thermal neutron capture cross sections. Eu and Dy can take up five neutrons in succession. Therefore, they have a low rate of burn off when used in control rods or in ceramics for radiation protection [166]. Table 44.14 lists the thermal neutron capture cross sections of these elements.

**Other Applications.** Rare earth compounds are used in the paint industry as dryers [186]. They are also used in the textile industry [187] and as oxidizing agents for self-cleaning ovens [188, 189].

Europium complexes are used as shift reagents in NMR spectroscopy [190].

Rare earth elements can be used in the third stage of wastewater purification for the precipitation of phosphates [191].

Table 44.14: Thermal neutron capture cross sections of some rare earth elements in n,  $\gamma$  reactions.

Rare earth element	Number of absorbing isotopes	Relative atomic mass	Abundance in nature, %	Thermal neutron capture cross section, $10^{-28} \text{ m}^2$	
				For natural isotope mixture	For single isotopes
Sm	1	149	13.8	5 600	66 000
Eu	5	151	47.8	4 300	9 000
		152			5 000
		153			420
		154			1 500
Gd	2	155	14.9	46 000	70 000
		157			180 000
		155			13 000
Dy	5	160	2.3	950	130
		161			680
		162			240
		163			220
		164			2 780

#### 44.11 Economic Aspects [192]

World production of rare earth minerals totalled ca. 96 500 t (57 000 t REO) in 1990, compared with an estimated output of ca 107 500 t (64 000 t REO) in 1989. The decrease in mineral output over these two years has been associated with a decrease in Australian and Chinese production. In particular, up to 1988 production and pricing policy of raw materials and separated rare earth elements were essentially stable. Chinese production and export of these products increased dramatically between 1988 and 1990 without a parallel increase in market demand, thus causing some destabilization of world pricing policies. Prices of rare earth materials during this period dropped by between 20 and 70%, depending on the rare earth element. China's export revenues also suffered a 40% decrease. Some stability has returned to the world market with China reducing output of rare earth minerals from 43 000 t (25 250 t REO) in 1989 to 27 500 t (16 500 t REO) in 1990. Exports of raw materials also dropped by 50% in 1990 and by 46% in 1991.

World rare earth consumption grew by less than 3% annually between 1980 and 1990 against a predicted growth of 6%. In 1980 the demand for rare earths expressed as oxide (REO) was ca 27 000 t. Rare earth consumption in 1990 is estimated at 35 000 t with a

market value of ca  $\$400 \times 10^6$ . Ores, concentrates and mixed rare earth compounds account for ca 75% of the tonnage consumption but only 25% of the total market value.

Rare earths in the form of metals and separated high-purity oxide for use in applications such as phosphors, magnets and superconductors, demand much higher added value and account for nearly 75% of the market. This latter market sector is currently showing a reasonable growth rate of ca. 15%/a.

Current estimates of world rare earth consumption by end use for 1990 and predicted values for 1996 are shown in Table 44.15. However, as is shown in Table 44.16, the balance of consumption for end use applications varies significantly between the major user countries. This can reflect differences in technological status, future commercial strategies, and the availability of rare earth stock.

Table 44.15: World markets for rare earth consumption by end use [192].

Use	1990		Predicted for 1996	
	% vol	% by value	% vol	% by value
Phosphors	3	37	4	40
Magnets	7	20	15	23
Catalyst	40	16	35	11
Glass	18	12	17	10
Metallurgy	26	4	22	2
Ceramics	2	6	2	8
Other	4	5	5	6
Total	100	100	100	100

Table 44.16: Rare earth consumption by end use application [192].

Application	United States 1989		Japan 1990		China 1990	
	% vol	tonnes REO	% vol	tonnes REO	% vol	tonnes REO
Glass and ceramics	43	7 524	67	3639		
Catalysis	42	7 350			30	2200
Metallurgy	14	2 450	4	217	56.5	4100
Permanent magnets			18	978	3	216
Agriculture					6.5	480
Phosphors			5.5	299		
Other	1 <sup>a</sup>	175 <sup>a</sup>	5.5 <sup>b</sup>	299 <sup>b</sup>	4	260
Total	100	17 500	100	5432	100	7256

<sup>a</sup> Includes permanent magnets, phosphors, and electronics.

<sup>b</sup> Includes catalysis.

New developments based on the less common rare earth elements or requiring only a single rare earth element can affect the supply/demand situation. A favorable cost/price situation will only exist if there is a good market for all the principal rare earth elements that occur in nature, since rates of production of the elements by the rare earth industry are interdependent.

Prices of rare earths can vary significantly depending upon the abundance of the rare earth element in the ore, the source of the product, the purity of the element or compound required, and the quantity of material purchased.

Approximate prices of rare earth oxides are given in Table 44.17. Reviews of the rare earth industry are given in [14, 192–194].

Table 44.17: Approximate prices of rare earth oxides in 1990 [192].

Rare earth oxide	Rhône-Poulenc		Molycorp	
	Purity, %	\$/kg	Purity, %	\$/kg
Ce	99.50	25.75	99.0	19.25
Dy	95.00	132.00	96.00	132.00
Er	96.00	190.00	98.00	143.00
Eu	99.99	1960.00	99.99	1639.00
Gd	99.99	136.50	99.99	132.00
Ho	99.90	510.00		
La	99.99	23.00	99.99	19.25
Lu	99.99	7000.00		
Nd	95.00	20.00	99.90	88.00
Pr	96.00	38.85	96.00	37.00
Sm	96.00	175.00	96.00	143.00
Tb	99.90	880.00	99.90	825.00
Tm	99.90	3600.00		
Yb	99.00	230.00		
Y	99.99	115.50	99.99	115.50

#### 44.12 Toxicology

The pure rare earth metals and their compounds are regarded as having low toxicities with respect to the Hodge Sterner classification system [195]. HALEY describes the rare earth elements as only slightly toxic [2, vol 4, pp 553–585; 196]; see also [1, part B2]. A further extensive review on this subject is provided by ARVELA [197].

Several authors investigations into the inhalation of rare earth oxides by humans (smoke from carbon arc lamps in cinemas) have been carried out [198–200]. Chest X rays show changes to the lungs caused by dust deposits, although these harmful effects are not caused by the rare earth elements, but by radioactive impurities, i.e., products of the radioactive decay of thorium and uranium. Modern methods of rare earth separation together with an increased use of bastnæsité have led to rare earth products that are virtually free from Th and U.

Experiments on animals showed that intravenous injection of rare earths caused impairment of liver function.

#### 44.13 References

1. Gmelin, 8th ed. Seltene Erden, A2–A5, B1–B7, C1–C3, C4a, C5–C6, C8, D1–D3.
2. K. A. Gschneidner, Jr., L. Eyring, (eds.) *Handbook on the Physics and Chemistry of Rare Earths* vol. 1–4, North Holland Publ., Amsterdam 1979.
3. L. Eyring (ed.): *Progress in the Science and Technology of the Rare Earths*, vol. 1, 1964; vol. 2, 1966; vol. 3, 1968, Pergamon Press, Oxford.
4. J. A. Gibson, G. S. Harvey: "Properties of the Rare Earth Metals and Compounds", *Technical Report*

- AFML-TR-65-430, Wright Patterson Air Force Base, OH, 1966.
5. F. H. Spedding, A. H. Daane: *The Rare Earths*, J. Wiley, New York 1961.
  6. F. Trombe, J. Loriais, P. Gaume-Mahn, Ch. H. La Blanchetais: "Scandium-Yttrium-Éléments des terres rares-Actinium" in P. Pascal (ed.): *Nouveau Traité de chimie minérale*, vol. 7, parts 1, 2, Masson, Paris 1959.
  7. International Union of Pure and Applied Chemistry (IUPAC): *Nomenclature of Inorganic Chemistry, Definition Rules 1970*, Butterworths, London 1971.
  8. Th. Moeller: "The Lanthanides" in I. C. Bailar, H. J. Emeleus, R. Nyholm, A. F. Trotman-Dickenson (eds.): *Comprehensive Inorganic Chemistry*, vol. 4, Pergamon Press, Oxford 1971, p. 1.
  9. J. W. Adams, E. R. Iherall: "Bibliography of the Geology and Mineralogy of the Rare Earths and Scandium to 1971", *Geological Bulletin 1366*, Washington 1973.
  10. J. W. Adams: "Distribution of the Lanthanides in Minerals", *Proc. Rare Earth Res. Conf. 7th* (1968) 28-30.
  11. J. W. Adams: "Resources" in J. G. Parker, C. T. Baroch (eds.): *The Rare Earth Elements, Yttrium and Thorium. A Materials Survey*, chap. 3, USBM Information Circular 8476, Washington 1973, pp. 22-39.
  12. United States Bureau of Mines: Mineral Commodity Summaries, and Unocal Company Reports, Washington 1991.
  13. G. Friedlander, J. W. Kennedy: *Lehrbuch der Kern- und Radiochemie*, Thieme, München 1962.
  14. J. A. Marinsky, L. F. Glendenin, C. D. Coryell, *J. Am. Chem. Soc.* 69 (1947) 2781.
  15. O. Erämetsä, *Acta Polytech. Scand. Chem. Ind. Metall. Ser. 37* (1965).
  16. D. A. Johnson, *J. Chem. Educ.* 57 (1980) 475.
  17. F. H. Spedding, B. J. Beaudry, *J. Less Common Met.* 25 (1971) 61.
  18. K. N. R. Taylor, M. I. Darby: *Physics of Rare Earth Solids*, Chapman and Hall, London 1972, pp. 1-324.
  19. R. D. Shannon, C. T. Prewitt, *Acta Crystallogr. Sect. B* B25 (1969) 925.
  20. T. Petzel, O. Greis, *Z. Anorg. Allg. Chem.* 396 (1973) 95.
  21. K. A. Gschneidner, Jr., *J. Less Common Met.* 17 (1969) 1.
  22. J. H. Van Vleck: *The Theory of Electric and Magnetic Susceptibilities*, Oxford University Press, Oxford 1932, pp. 1-395.
  23. K. N. R. Taylor, *Contemp. Phys.* 11 (1970) 423-454.
  24. H. R. Kirchmayr, *Z. Metallkd.* 60 (1969) 699-708.
  25. H. R. Kirchmayr, *Z. Metallkd.* 60 (1969) 778-784.
  26. W. E. Wallace: *Rare Earth Intermetallics*, Academic Press, New York 1973.
  27. K. A. Gschneidner, Jr.: *Rare Earth Alloys*, Van Nostrand, Princeton 1961.
  28. K. H. J. Buschow, *Rep. Prog. Phys.* 42 (1979) 1373-1477.
  29. M. Hansen, K. Anderko: *Constitution of Binary Alloys*, 2nd ed., McGraw-Hill, New York 1958, 1st Supplement R. P. Elliot, 1965, 2nd Supplement T. A. Shunk, 1969.
  30. W. G. Moffatt: *The Handbook of Binary Phase Diagrams*, General Electric, Schenectady 1978.
  31. K. A. Gschneidner, Jr., M. E. Verkade: *Selected Cerium Phase Diagrams, IS-RIC-7 Rare Earth Information Centre*, Iowa State University 1974.
  32. Soc. prod. chim. terres rares, FR 995112, 1949.
  33. A. E. Barse, G. D. Calkins, J. W. Glegg, R. B. Filbert, *Chem. Eng. Prog. Monogr. Ser.* 50 (1954) 235-239.
  34. M. Smutz, G. L. Bridger, K. G. Shaw, M. E. Whatley, *Chem. Eng. Prog. Symp. Ser.* 50 (1954) 13, 167-170.
  35. American Potash and Chemical Corp., US 2900231, 1952.
  36. V. E. Shaw, *Rep. Inst. U.S. Bur. Mines RI 5474* (1959) 1-12.
  37. Y. Hirashima, J. Shiokawa, *Nippon Kagaku Kaishi*, 1973 no. 3, 496-499; *Chem. Abstr.* 78 (1973) 152030.
  38. *Chem. Eng. (N.Y.)* 74 (1967) 2, 122-123.
  39. P. R. Kruesi, G. Duker, *J. Met.* 17 (1965) 847-849.
  40. D. J. Bauer, V. E. Shaw, *Rep. Invest. U.S. Bur. Mines RI 6381* (1964) 1-15.
  41. B. I. Kogan, I. P. Skripka, *Redk. Elem.* 8 (1973) 3-57.
  42. H. Richter, A. Krause, *Chem. Tech. (Leipzig)* 17 (1965) 707-710.
  43. G. Trombe, DE-OS 2238665, 1973.
  44. W. Brugger, E. Greinacher, *J. Met.* 19 (1967) 32-35.
  45. Th. Goldschmidt AG, DT 956993, 1954.
  46. Soc. prod. chim. terres rares, FR 1209251, 1958.
  47. F. H. Spedding, J. E. Powell in F. C. Nachod, J. Schubert (eds.): *Ion Exchange Technology*, Academic Press, New York 1956, pp. 359-390.
  48. C. D. Scott, R. D. Spence, W. G. Sisson: "Pressurised Annular Chromatography for Continuous Separation", *J. Chromatogr.* 126 (1976) 381-400.
  49. J. M. Begovich, W. G. Sisson: "A Rotating Annular Chromatograph for Continuous Metals Separation and Recovery", *Resour. Conserv.* 9 (1982) 219-229.
  50. J. M. Begovich, C. H. Byers, W. G. Sisson: "A High Capacity Pressurised Continuous Chromatograph", *Sep. Sci. Technol.* 18 (1983) 1167-1191.
  51. V. T. Taniguchi, A. W. Doty, C. H. Byers: "Large Scale Chromatographic Separations using Continuous Displacement Chromatography (CDC)" in R. G. Bautista, M. M. Wong (eds.): *Rare Earths Extraction, Preparation and Applications*, The Minerals, Metals and Materials Soc., annual meeting, Las Vegas 1989, 147-161.
  52. J. P. Suris, Jr., G. R. Choppin, *J. Am. Chem. Soc.* 79 (1957) 855-859.
  53. S. W. Mayer, E. R. Tompkins, *J. Am. Chem. Soc.* 69 (1947) 2866-2874.
  54. J. E. Powell, F. H. Spedding, *Trans. Am. Inst. Min. Metall. Pet. Eng.* 215 (1959) 457-463.
  55. P. Conrad, M. Caude, R. Rosset, *Sep. Sci.* 7 (1972) no. 5, 457-463.
  56. P. Conrad, M. Caude, R. Rosset, *Sep. Sci.* 9 (1974) no. 4, 269-285.
  57. R. E. Linstrom, J. O. Wingert, *Rep. Invest. U.S. Bur. Mines RI 6131* (1961) 1-21.
  58. D. B. James, J. E. Powell, F. H. Spedding, *J. Inorg. Nucl. Chem.* 19 (1961) 133-141.

59. W. L. Silvermail, M. M. Woyski: "Commercial Ion Exchange Separation of the Rare Earths", *Proc. Rare Earth Res. Conf. 6th*, Gatlinburg, May 1967, 678-690.
60. Santoku Metals Industry Co., JP 7028292, 1966.
61. GTE Sylvania Inc., US 3482932, 1969.
62. C. Persiani, J. F. Cosgrove, R. Walters, D. J. Bracco, *Sep. Sci.* 2 (1967) no. 6, 789-796.
63. D. Asher et al., *Ind. Eng. Chem. Process Des. Dev.* 1 (1962) no. 1, 52-56.
64. J. E. Powell, H. R. Burkholder, *J. Chromatogr.* 36 (1968) 99-104.
65. J. E. Powell, H. R. Burkholder, *J. Chromatogr.* 29 (1967) 210-217.
66. W. Fischer, W. Dietz, O. Jubermaun, *Naturwissenschaften* 25 (1937) 348.
67. W. Fischer, K. Biesenberger, J. Heppner, U. Neitzel, *Chem. Ing. Tech.* 36 (1964) 85-99.
68. F. Horn, *Chem. Ing. Tech.* 36 (1964) 99-111.
69. N. M. Rice, *Chem. Ind. (London)* 1977, Sept., 718-723.
70. C. G. Brown, L. G. Sherrington: "Solvent Extraction used in Industrial Separation of Rare Earths", *J. Chem. Technol. Biotechnol.* 29 (1979) 193-209.
71. R. F. Sebenik, B. M. Sharp, M. Smutz, *Sep. Sci.* 1 (1966) no. 4, 375-386.
72. E. Hesford, E. E. Jackson, H. A. C. McKay, *J. Inorg. Nucl. Chem.* 9 (1959) 279-289.
73. D. Scargill et al., *J. Inorg. Nucl. Chem.* 4 (1957) 304-314.
74. Th. Goldschmidt AG, DT 1592120, 1967.
75. Thorium LTD., GB 1180922, 1966.
76. G. W. Mason, D. N. Metta, D. F. Peppard, *J. Inorg. Nucl. Chem.* 38 (1976) 2077.
77. J. Alstad, J. H. Augustson, T. Danielssen, L. Farbu: "Comparative Study of the Rare Earth Elements in Extraction by HDEHP/Shell Sol T from Nitric and Sulphuric Acid Solutions" in G. V. Jeffreys (ed.): *Proc. Int. Solvent Extr. Conf.* 1974, 1083-1102.
78. T. B. Pierce, P. F. Peck, *Analyst (London)* 88 (1963) 217-221.
79. N. E. Thomas, S. Smutz, L. Burkhart, *Ind. Eng. Chem. Fundam.* 10 (1971) 453-458.
80. D. S. Flett, G. W. Cutting, P. Carey, *Proc. Int. Miner. Process. Congr. 10th* (1973) Paper 23, (Pub. 1974) 1147-1167.
81. D. E. Peppard, G. W. Mason, S. W. Moline in R. G. Bautista, M. M. Wong (eds.): *Rare Earths: Extraction, Preparation and Applications*, The Minerals, Metals and Materials Soc., Warrendale 1989.
82. D. E. Peppard, E. P. Horwitz, G. W. Mason in R. G. Bautista and M. M. Wong (eds.): *Rare Earths: Extraction, Preparation and Applications*, The Minerals, Metals and Materials Soc., Warrendale 1989.
83. K. S. Han, K. Tozawa: "Thermodynamic Prediction of Coefficients for the Solvent Extraction of the Rare Earths" in R. G. Bautista, M. M. Wong (eds.): *Rare Earths: Extraction, Preparation and Applications*, The Minerals, Metals and Materials Soc., Warrendale 1989, pp 115-128.
84. C. F. Baes, Jr., *J. Inorg. Nucl. Chem.* 24 (1962) 707-720.
85. Z. Kolarik, S. Drazanova, V. Chotivka, *J. Inorg. Nucl. Chem.* 33 (1971) 1125-1133.
86. R. A. Alekperov, S. S. Geibatova, *Dokl. Chem. (Engl. Transl.)* 178 (1968) 29.
87. R. D. Korpusov, G. L. Vaks, E. N. Petrusheva, *Russ. J. Inorg. Chem. (Engl. Transl.)* 14 (1969) 1004.
88. F. J. Seelay, D. J. Crouse, *J. Chem. Eng. Data* 11 (1966) 42.
89. F. J. Seelay, D. J. Crouse, *J. Chem. Eng. Data* 16 (1971) 393.
90. US Atomic Energy Commission, US 3294494, 1966.
91. J. S. Preston, A. C. DuPreez, *Rep. Mintek M378* (1988).
92. P. Th. Gerontopolis, L. Rigali, P. G. Barbano, *Radiochim. Acta* 4 (1965) 75-78.
93. Government of the United States, US 3323857, 1967.
94. US Atomic Energy Commission, US 3409415, 1968.
95. T. V. Healey, *J. Inorg. Nucl. Chem.* 19 (1961) 314-327.
96. B. H. Lucas, G. M. Ritcey, *CIM Bull.* 68 (1975) no. 753, 124-130.
97. B. Z. Zhang et al., *Hydrometallurgy* 9 (1982) 205-210.
98. K. A. Gschneidner, Jr., *Rare Earths in the Electronics Industry* 88 (1991) 63-94; Royal Soc. Chem., Special Publication, Fine Chemicals for the Electronics Industry II.
99. H. W. Harrah: Deco Trefoil, Denver Equipment Comp., Denver, CO, Nov.-Dec., 9, 1967.
100. Forskningsgruppe for Sjeldna Jordarter, US 3751553, 1971.
101. Molybdenum Corp., US 3640678, 1970.
102. H. N. McCoy, *J. Am. Chem. Soc.* 63 (1941) 1622.
103. E. Greinacher, K. Reinhardt: "Seltene Erden" in H. Harnisch, R. Steiner, K. Winnacker (eds.): *Chemische Technologie*, 4th ed., vol. 2, "Anorganische Technologie I", Hanser Verlag, München 1982, pp. 678-707.
104. E. Morrice, M. M. Wong, *Miner. Sci. Eng.* 11 (1979) 125-136.
105. Molybdenum Corp., US 3729397, 1970.
106. T. A. Henrie, *J. Met.* 16 (1964) 978-981.
107. O. N. Carlsson, J. A. Hæfling, F. A. Schmidt, F. H. Spedding, *J. Electrochem. Soc.* 107 (1960) 540-545.
108. T. T. Campbell, F. E. Block, *J. Met.* 11 (1959) 744-746.
109. Th. Goldschmidt AG, DT 2303697, 1973.
110. R. E. Cech, *J. Met.* 26 (1974) 32.
111. C. E. Habermann, A. H. Daane, P. E. Palmer, *Trans. AIME* 233 (1965) 1038-1042.
112. A. Brusdeylins, *Chem. Ztg.* 97 (1973) 343-347.
113. O. B. Michelsen (ed.): *Analysis and Application of Rare Earth Materials*, NATO Advanced Study Institute, Kjeller, Norway, 23-29 Aug., 1972, Universitetsforlaget, Oslo 1973.
114. K. A. Gschneidner, Jr., L. Eyring (eds.) *Handbook on the Physics and Chemistry of Rare Earths*, vol. 13, North-Holland Publ., Amsterdam 1991.
115. R. J. Conzemius, S.-K. Zhao, R. S. Houk, H. J. Svec, *Int. J. Mass Spectrom. Ion Processes* 61 (1984) 277.
116. K. A. Gschneidner, Jr., L. Eyring (eds.): *Handbook on the Physics and Chemistry of Rare Earths*, vol.



- 6., chap. 47, North-Holland Publ., Amsterdam 1984, pp. 1-111.
117. K. A. Gschneidner, Jr., L. Eyring (eds.): *Handbook on the Physics and Chemistry of Rare Earths*, vol. 5, chap. 44, North-Holland Publ., Amsterdam 1982, pp. 321-386.
118. B. G. Hyde, D. J. M. Bevan, L. Eyring, *Phil. Trans. R. Soc. London Ser. A* 259 (1966) no. 1106, 583.
119. K. A. Gschneidner, Jr., L. Eyring (eds.): *Handbook on the Physics and Chemistry of Rare Earths*, vol. 8, chap. 56, part I, North-Holland Publ., Amsterdam 1986, 203-334.
120. K. A. Gschneidner, Jr., L. Eyring (eds.) *Handbook on the Physics and Chemistry of Rare Earths*, vol. 9., chap. 59, part II, North-Holland Publ., Amsterdam 1987, p. 320.
121. A. W. Sleight, C. T. Prewitt, *Inorg. Chem.* 7 (1968) 2282.
122. T. Petzel, *Inorg. Nucl. Chem Lett.* 10 (1974) 119.
123. E. D. Eastmann et al., *J. Am. Chem. Soc.* 72 (1950) 2248.
124. K. A. Gschneidner, Jr., L. Eyring (eds.): *Handbook on the Physics and Chemistry of Rare Earths*, vol. 13., chap. 89, North-Holland Publ., Amsterdam 1990, pp. 191-281.
125. G. V. Samsonov: *High Temperature Compounds of Rare Earths with Nonmetals*, Consultants Bureau, New York 1965.
126. Th. Moeller et al., *Chem. Rev.* 65 (1965) 1.
127. R. E. Sievers, K. J. Eisentraut, C. S. Springer, Jr.: "Volatile Rare Metal Chelates of  $\beta$ -Diketones" in R. F. Gould (ed.): *Adv. Chem. Ser.* 71 (1967) 141-154.
128. H. Schumann, *Nachr. Chem. Tech. Lab.* 27 (1979) 393.
129. G. Wilkinson, J. M. Birmingham, *J. Am. Chem. Soc.* 76 (1954) 6210.
130. F. A. Hart, M. S. Saran, *Chem. Commun.* 1968, 1614.
131. F. A. Hart, A. G. Massey, M. S. Saran, *J. Organomet. Chem.* 21 (1970) 147.
132. K. A. Gschneidner, Jr., L. Eyring (eds.): *Handbook on the Physics and Chemistry of Rare Earths*, vol. 7., chap. 53, North-Holland Publ., Amsterdam 1985, p. 446.
133. A. Raman, *Z. Metallkd.* 68 (1977) 163-172.
134. A. Raman, *Z. Metallkd.* 67 (1976) 780-789.
135. H. Zulstra, *Chem. Tech. Technol.* 2 (1972) 280-284.
136. K. H. J. Buschow, A. R. Miedema: "Hydrogen Absorption in Rare Earth Intermetallic Compounds" in A. F. Andresen, A. J. Maeland (eds.): *Hydrides Energy Storage Proc. Int. Sym., 1977*, (Pub. 1978) 235-249.
137. C. E. Lundin, R. W. Sullivan: "The Safety Characteristics of Lanthanum-Nickel (LaNi<sub>3</sub>) Hydrides" in T. N. Veziroglu (ed.): *Hydrogen Energy Proc. Hydrogen Econ. Miami Energy Conf. 1974*, Plenum Publishing, New York 1975, pp. 645-658.
138. I. Lambert, A. Percheron-Guegan, J. Montel, *J. Chim. Phys. Phys. Chim. Biol.* 74 (1977) no. 3, 380-381.
139. K. A. Gschneidner, Jr., L. Eyring (eds.) *Handbook on the Physics and Chemistry of Rare Earths*, vol. 11, chap. 76, North-Holland Publ., Amsterdam 1988, pp. 293-321.
140. K. A. Gschneidner, Jr., L. Eyring (eds.): *Handbook on the Physics and Chemistry of Rare Earths*, vol. 12, chap. 83, North-Holland Publ., Amsterdam 1989, pp. 133-212.
141. *Goldschmidt Informiert*, 4 (35), 1-90 (1975).
142. *Goldschmidt Informiert*, 2 (48), 1-75 (1979).
143. *Proc. 7th Int. Workshop Rare Earth-Co Permanent Magnets and their Applications*, China Academic, Peking 1983.
144. Socony Mobil Oil Compl. Inc., US 3173854, 1961.
145. *Molycorp Application Report*, vol. 1, "A Bibliography. Six Years of Research in Catalysis with Rare Earth Elements", no. 7101, 1964-1970, vol. 2, "A Bibliography of the Research in Catalysis with the Rare Earth Elements", no. 7907, 1971-1976.
146. M. P. Rosynek, *Catal. Rev. Sci. Eng.* 16 (1977) 111-154.
147. S. C. Sorenson, J. A. Wrongkiewicz, L. B. Sis, G. P. Wirtz, *Am. Ceram. Soc. Bull.* 53 (1974) 446-449.
148. V. T. Coon, W. E. Wallace, R. S. Craig: "Methanation by Rare Earth Intermetallic Catalysts", in J. G. McCarthy, J. J. Rhyne (eds.): *Rare Earth Research Conf. 13th*, 1977, Plenum, New York 1978.
149. W. R. Grace, US 3903020, 1975.
150. Engelhard, US 4021185, 1977.
151. Government of the United States, US 3794473, 1972.
152. Allis-Chalmers Manufacturing Comp., US 3405008, 1965.
153. K. Shirili, S. Ihara, H. Sato, *Denshi Gijutsu Sogo Kenkyusho Iho* 38 (1974) 378-382; *Chem. Abstr.* 82 (1975) 173473c.
154. G. Robert, M. Forestier, C. Deportes, *Journ. Int. Etude Piles Combust. C. R. 3rd* (1969) 97-105.
155. Molycorp Inc.: "Overview of Application Possibilities", no. 48.
156. P. R. Ryason, US 4105517, 1977.
157. J. Kiwi, M. Gratzel, *Angew. Chem.* 91 (1979) 659-660.
158. B. Wyatt, *Ind. Res. Dev.* 21 (1979) June, 64-65.
159. General Refractories Co., US 3974108, 1974.
160. Tokai Rika Co., Ltd., JP 7652409, 1974.
161. P. H. Schmidt, D. C. Joy, *J. Vac. Sci. Technol.* 15 (1978) 1809-1810.
162. T. C. Shutt, M. Marlin, C. J. Lewis, J. Drobnick, *J. Can. Ceram. Soc.* 40 (1971) 29-37.
163. T. C. Shutt, G. Barlow, *Am. Ceram. Soc. Bull.* 51 (1972) 155-157.
164. Harshaw Chem. Co., US 2992123, 1959.
165. A. Nedeljkovic, R. L. Cook, *Vitreous Enameller* 26 (1975) 2-13.
166. W. Mialki, *Metall (Berlin)* 19 (1965) 16-21.
167. Dentists' Supply Comp., US 2895050, 1956.
168. National Research Development Corp., GB 1529984, 1976.
169. Zahnfabrik Bad Nauheim KG, DT 1813163, 1968.
170. L. Tcheichvili, M. N. P. DeMaeques, *Keram. Z.* 30 (1978) no. 3, 138-139; 30 (1978) no. 5, 252-254.
171. E. Hamann, H. Manger, L. Sleinke, *Automot. Appl. Sens. SAE Spec. Publ.* SP-418 (1977) 53-80.
172. D. Janke, W. A. Fischer, *Arch. Huttenw.* 48 (1977) 255-260.
173. Molycorp Inc.: "Overview of Application Possibilities", no. 40.

174. I. C. Huseby, G. Petzow, *Powder Metall. Int.* 6 (1974) 17-19.
175. J. R. Maldonado: *IEEE Int. Conv. Dig.* 1972, 190-191.
176. N. V. Philips' Gloeilampenfabrieken, DE-OS 2037197, 1969.
177. Matsushita Electric Industrial Co., Ltd., DE-OS 2055197, 1969.
178. J. B. Chesney, *J. Am. Ceram. Soc.* 46 (1963) 197-202.
179. Matsushita Electric Industrial Co., Ltd., US 3586642, 1968.
180. Molycorp Inc.: "Overview of Application Possibilities", no. 21.
181. Hitachi Ltd., JP 74129199, 1973.
182. Molycorp Inc.: "Overview of Application Possibilities", no. 54.
183. G. M. Schwab, F. Bohla, *Z. Naturforsch.* 32 (1968) no. 10, 1555-1558.
184. Molycorp Inc.: "Overview of Application Possibilities", no. 28.
185. R. E. Harrington, *Environ.* 13 (1967) March, 32-33; 13 (1967) June, 32-34; 13 (1967) Sept., 30-32.
186. Molycorp Inc.: "Overview of Application Possibilities", no. 38.
187. Molycorp Inc.: "Overview of Application Possibilities", no. 46.
188. A. B. Stiles, US 3266477, 1966.
189. Fedders Corp., US 3627560, 1970.
190. B. C. Milyo, *Chem. Soc. Rev.* 2 (1973) 49.
191. North American Rockwell Corp., DE-OS 1926969, 1968.
192. Roskill Information Services: *The Economics of Rare Earths and Yttrium*, 8th ed., London 1991.
193. B. Campna, *Bull. Ver. Schweiz. Pet. Geol. Ing.* 43 (1977) no. 104, 1-28.
194. *Inf. Chim.* 190 (1979) 67-70.
195. H. C. Hodge, H. S. Sterner, *Am. Ind. Hyg. Assoc. Q.* 10 (1943) 93.
196. Th. A. Haley, *J. Pharm. Sci.* 54 (1965) no. 5, 663-670.
197. P. Arvela in H. Grobecker et al. (eds.) *Progress in Pharmacology*, Publ. G. Fischer Verlag, Stuttgart 1979, 69-114.
198. R. Hoschek: "Die 'Cer-pneumokoniose' nach Einatmen von natürlichen Seltenen Erden", *Schriftenreihe Arbeitsmedizin-Sozialmedizin-Arbeits-hygiene*, vol. 18, Genter, Stuttgart 1968.
199. M. Menz, E. Kaufman, *Z. Unfallmed. Berufskr.* 65 (1972) no. 1, 62-73.
200. J. Sykora, F. Huzl, A. Kubat, M. Vykrocil, *Zentralbl. Arbeitsmed. Arbeitsschutz* 16 (1966) no. 1, 3-9.

## 45 Cerium

KLAUS REINHARDT, HERWIG WINKLER

45.1 Introduction .....	1743	45.3.1 Flint Alloy .....	1750
45.2 Cerium Mischmetal .....	1743	45.3.2 Permanent Magnets .....	1752
45.2.1 Preparation of the Raw Materials ..	1744	45.3.3 Hydrogen Storage .....	1752
45.2.1.1 Wet Chemical Attack .....	1744	45.4 Compounds .....	1753
45.2.1.2 Chlorination .....	1744	45.4.1 Production .....	1753
45.2.2 Fused-Salt Electrolysis .....	1745	45.4.2 Uses .....	1753
45.2.2.1 Iron and Graphite Cells .....	1745	45.5 Analysis .....	1754
45.2.2.2 Ceramic Cells .....	1747	45.6 Economic Aspects .....	1755
45.2.2.3 Oxide Process .....	1747	45.7 Toxicology and Occupational	
45.2.3 Properties .....	1748	Health .....	1755
45.2.4 Uses .....	1749	45.8 References .....	1756
45.3 Alloys .....	1750		

### 45.1 Introduction

Cerium is the most abundant rare-earth element and exceeds in abundance such well-known elements as tin, cobalt, and lead. The following article treats pure cerium and rare-earth mixtures in which cerium content either exceeds the naturally occurring composition or determines the overall properties or economics. The term cerium group, or light rare-earth elements, includes lanthanum through europium inclusively.

The presence of the rare-earth elements lanthanum to lutetium at the position of lanthanum (atomic number 57) in the periodic table is due to the fact that, starting with cerium ( $[\text{Xe}] 4f^1 5d^1 6s^2$ ), 14 electrons are able to enter the inner  $4f$  orbital. Lanthanum, which has an empty  $4f$  level ( $4f^0$ ), represents the stable electronic configuration. This configuration is also attained by tetrapositive cerium, which explains why cerium has not only the normal rare-earth  $3+$  oxidation state, but also a  $4+$  state. This exceptional oxidation state simplifies separation of cerium from the other rare-earth elements.

Cerium was discovered in 1814 by BERZELIUS and named after the asteroid Ceres, which had been discovered in 1800–1801.

### 45.2 Cerium Mischmetal

*Cerium mischmetal* or more simply *mischmetal* is a mixture of rare-earth metals of the cerium group with cerium as the major constituent. Mischmetal is the lowest priced rare-earth metal because no expensive chemical separation is needed to produce it. It is produced predominantly by fused-salt electrolysis of rare-earth chlorides. Pure rare-earth metals of the cerium group are produced by fused-salt electrolysis of a mixture of chlorides and fluorides. The electrolytic reduction of rare-earth oxides of the cerium group dissolved in a fluoride electrolyte has been put into production recently. Metallothermic reduction of rare-earth chlorides of fluorides is also employed.

Mischmetal was first produced industrially in 1908 by AUER VON WELSBACH, who succeeded in finding an outlet for surplus rare earth in the production of lighter flints. At that time, monazite was used exclusively as the source of thorium needed for the manufacture of incandescent mantles.

### 45.2.1 Preparation of the Raw Materials

Rare-earth minerals in which cerium predominates over lanthanum, praseodymium, and neodymium (the other elements in the cerium group) are *monazite*, (RE, Th)PO<sub>4</sub>, from beach placers of India, Southeast Asia, Australia, South Africa, and Brazil, associated with cassiterite, rutile, ilmenite, and zircon and *bastnæsite*, REFCO<sub>3</sub>, from the carbonatitic deposit of the Mountain Pass mine in California and from the iron ore deposit of Bayan Obo in Inner Mongolia (China).

Monazite and bastnæsite are generally concentrated by physical methods such as gravity concentration, flotation, and magnetic separation [1, B1, pp. 60–67]. The rare-earth concentrates are converted into rare-earth chloride hydrates by wet chemical methods or into anhydrous rare-earth chlorides by high-temperature chlorination.

#### 45.2.1.1 Wet Chemical Attack

After being ground (50 μm–1 mm), the concentrates are attacked by acids or caustic soda [1, B1, pp. 67–104].

**Monazite.** At temperatures between 140 and 170 °C, concentrated sodium hydroxide solution (50–70%) reacts with the phosphates:

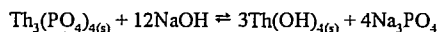
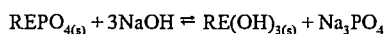

The attack is carried out in an autoclave [13]. More concentrated sodium hydroxide solutions (> 70%) react at lower temperature [14]. The rare-earth hydroxides are dissolved in hydrochloric acid. The thorium does not dissolve if the pH is kept close to 4. Trisodium phosphate is a saleable by-product after recrystallization.

**Bastnæsite.** The carbonates are attacked by hydrochloric acid. The residue of rare-earth fluorides is converted by alkaline treatment into rare-earth hydroxides, which can be used to neutralize the acid solution resulting from the hydrochloric acid attack [15]. Concen-

trated sodium hydroxide solution attacks bastnæsite to form rare-earth hydroxides, which are dissolved in hydrochloric acid [16].

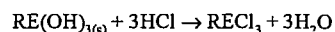
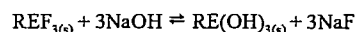

The rare-earth chloride solution obtained by these various processes is evaporated to form the hexahydrates (*mp* 120–130 °C), which solidify on cooling. The rare-earth chloride hexahydrates must be dehydrated for fused-salt electrolysis. Dehydration is carried out under conditions that avoid excessive formation of rare-earth oxide chlorides by hydrolysis:



The dehydration is carried out either in vacuo or by adding salts like CaCl<sub>2</sub>, NaCl, or NH<sub>4</sub>Cl that reduce hydrolysis.

Oxide chlorides increase the viscosity of the electrolyte and cause reoxidation of the rare-earth metals that are formed. However, rare-earth oxide chloride content near 5% is not detrimental, perhaps even desirable, for one special type of electrolytic cell, the ceramic cell. Dehydration can then be carried out in metal ovens or on heated rotating steel plates, at temperatures between 170 and 600 °C, depending on the process. In modern plants, spray drying and fluidized-bed drying are employed for the dehydration process. Special materials like titanium and Hastelloy can be used to avoid corrosion by the hydrochloric acid generated in the off-gas during drying.

#### 45.2.1.2 Chlorination

The chlorination of rare-earth ores [17] in a shaft furnace at 900–1100 °C produces anhydrous rare-earth chlorides that can be used directly for fused-salt electrolysis. The reaction proceeds as follows:

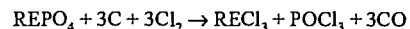
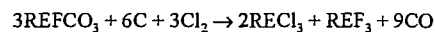

Table 45.1: Typical analyses of rare-earth chlorides from various sources.

Element, as oxide	RECl <sub>3</sub> ·6H <sub>2</sub> O from wet chemical treatment, % <sup>a</sup>						RECl <sub>3</sub> from high-temperature chlorination, % <sup>a</sup>
	Brazil	China	France	India	Malaysia	United States	Germany
RE <sub>2</sub> O <sub>3</sub>	458	45.8	47	46	46.1	46	65–67
REF <sub>3</sub>							6–10
CeO <sub>2</sub> /TREO <sup>b</sup>	47.2	50.0	49	46	50.3	50	48–50
Na <sub>2</sub> O				1	0.66		< 0.2
MgO				1		0.2	< 0.3
CaO	0.63		0.5	1	0.59	0.4	< 2
BaO						< 0.1	< 3
Fe <sub>2</sub> O <sub>3</sub>	0.03			0.005		0.02	< 0.1
PbO	100 ppm	22 ppm	230 ppm	10 ppm	15 ppm		< 50 ppm
P <sub>2</sub> O <sub>5</sub>	trace	trace	0.02	0.01			< 0.2
SO <sub>3</sub>	0.1	0.06	0.14	0.05			< 0.1
SiO <sub>2</sub>				0.05			< 0.1

<sup>a</sup>Unless otherwise stated.

<sup>b</sup>The cerium(IV) oxide content divided by the total rare-earth oxide content.

Bastnæsite yields a mixture of rare-earth chlorides and fluorides; monazite yields the chlorides. In the case of monazite, the radioactivity, caused mainly by radium, a disintegration product of thorium, remains with the rare-earth chlorides. In addition, ThCl<sub>4</sub> must be recovered from the off-gas to avoid environmental pollution. Therefore, thorium-free monazite should be used if available. The recovery of POCl<sub>3</sub> is an economic necessity.

Typical analyses of rare-earth chlorides from various sources are listed in Table 45.1.

### 45.2.2 Fused-Salt Electrolysis

For proprietary reasons, there are no modern detailed publications on the process technology for production of mischmetal by fused-salt electrolysis. The know-how of the producers covers optimization of electrolytic cell construction for continuous operations, special refractories resistant to the aggressive salt and metal melt, and maximization of current efficiency by the choice of the composition of the electrolyte, with a view to the viscosity, temperature, oxygen content, and solubility of deposited metal in the melt.

The kind of electrolytic-cell refractory characterizes the two main processes for the production of mischmetal: (1) iron/graphite and (2) ceramic [18, 19].

Independent of the type of cell, the amperage, voltage, electrode distance, and current

density are chosen to reach the reduction potentials of the rare-earth metals and to avoid an excessive electrolyte temperature, which may cause vaporization of the electrolyte, attack of the refractory lining by the electrolyte and metal, and formation of metal fogs.

Cerium deposits at a lower voltage than praseodymium, neodymium, and especially lanthanum. Samarium and europium are reduced at the cathode only to the 2+ oxidation state. Stirring by the chlorine liberated at the anode or diffusion allows both elements to migrate to the anode, where they are reoxidized [20]. Metal fogs reduce current efficiency similarly.

Added rare-earth fluorides and alkali and alkaline-earth chlorides and fluorides having decomposition voltages higher than those of the rare-earth chlorides lower viscosity, increase the conductivity, and improve the metal yield.

#### 45.2.2.1 Iron and Graphite Cells

The iron or graphite crucible or pot serves directly as the cathode. Iron crucibles made of spheroidal cast iron are directly connected as the cathode, whereas graphite crucibles, which are protected by an iron housing against air oxidation, are connected via this iron housing.

Graphite-lined iron pots are connected directly. Crucibles up to an electrolyte volume

of 50 L are round; larger crucibles are rectangular. The schematic design of a rectangular graphite-lined iron cell is shown in Figure 45.1. The anodes consist of graphite or special carbon and can be moved vertically to adjust the amperage and current density.

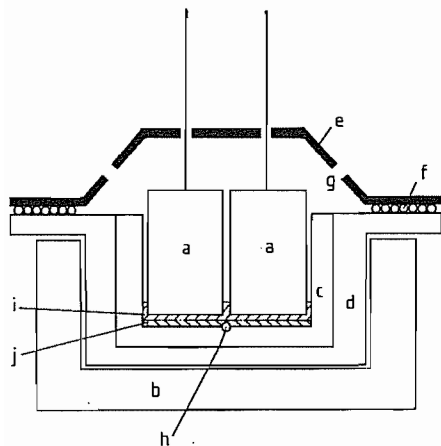

**Figure 45.1:** Schematic design of a rectangular graphite-lined iron cell (Th. Goldschmidt AG): a) Graphite anodes; b) Insulated housing; c) Graphite lining (cathode); d) Iron crucible; e) Hood; f) Seal; g) Feeding chute and chlorine suction; h) Bottom tap; i) Electrolyte melt; j) Mischmetal deposit.

The electrolysis is started via short-circuit heating by melting rare-earth chlorides and mischmetal down until a sufficient amount of melt is obtained for electrolysis. Already molten chlorine, for example, from the chlorination process, also may be used. Fresh rare-earth chlorides are fed as solids.

As a result of the higher heat losses by the iron and graphite cathode, the so-called cooled cathode, the mischmetal is electrodeposited in the form of dendritic sponge or droplets, together with solidified electrolyte, at the bottom of the cell. The deposition of solid mischmetal diminishes the damage to the refractory lining.

Toward the end of the electrolysis, the metal is melted by increasing voltage and amperage or by external heating via gas or resistance heating. Before tapping, the temperature of the metal must be 850–950 °C. The temperature of the electrolyte at the surface may be 100 °C higher. Addition of iron scrap lowers

the melting point, making the melt easier to handle. The total content of the cell is cast into molds by tipping or bottom pouring; reoxidation of the molten metal is prevented by the residual electrolyte. The mischmetal settles to the bottom of the mold and is covered by the electrolyte, which can be removed after solidification with an air chisel. The separation of the residual electrolyte from the liquid metal can be accomplished via a mold that acts as part of a siphon: the metal collects at the bottom, while the electrolyte overflows. Mischmetal may be recast more cleanly.

Immediately after tapping, the electrolysis is restarted by feeding fresh rare-earth chlorides, which melt instantly in the hot cell.

The residual electrolyte, in which europium and samarium are enriched, especially when rare-earth fluorides are involved, may be recycled for further enrichment and later used for winning those two elements [21].

The cells are covered with a hood. The chlorine formed at the anode is removed from the exhaust gases by alkaline scrubbing; the resulting hypochlorite is either reduced to chloride or sold. Recovery of the chlorine itself is normally uneconomical because of dilution by air.

In modern plants, direct current is supplied by thyristor-controlled silicon rectifiers; in older plants, it is supplied by transformer-controlled selenium rectifiers. The rectifiers are connected in parallel, series, or individually to the cells. Cell voltage ranges between 6 and 15 V, depending on the radiative loss of heat. The amperage may be as high as 50 kA. The current density depends on the cell design: in large rectangular cells it is  $\leq 2 \text{ A/cm}^2$ , in smaller ones it is much higher. The current efficiency can reach 75%.

From 2 to 2.5 kg of rare-earth chlorides are consumed to produce 1 kg of mischmetal. The metal yield is between 85 and 95%, depending on the extent the residues are recycled. For a 50-kA cell, the daily production is nearly 1 t. The d.c. power consumption per kilogram of mischmetal produced is 10–15 kWh.

### 45.2.2.2 Ceramic Cells

Figure 45.2 shows the construction of a ceramic cell [19]. Electrolysis takes place in a ceramic crucible. The crucibles of small, simple cells have a diameter of ca. 30 cm and a height of ca. 50 cm. Further development resulted in the bigger ceramic cells now in operation.

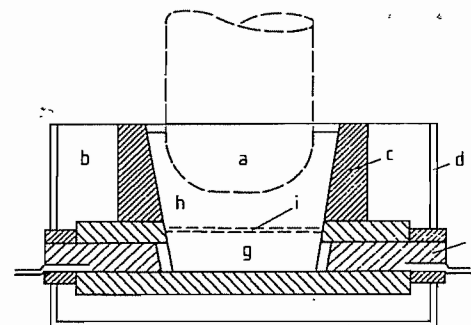

**Figure 45.2:** Ceramic cell [19]: a) Graphite anode; b) Insulation; c) Ceramic crucible; d) Iron housing; e) Current supply for cathode; f) Cathode; g) Mischmetal; h) Electrolyte melt; i) Rare-earth oxide chloride diaphragm.

A block of graphite or iron at the bottom of the crucible serves as the cathode. If iron cathodes are used, contamination of mischmetal with iron cannot be avoided. Mischmetal at the electrolysis temperature of ca. 900 °C attacks most of the construction materials in the electrolytic cell. The working life of the ceramic cells is limited to a maximum of 1 year.

The current density and voltage are controlled by raising or lowering an anode of amorphous carbon. Service life of the anode is between 30 and 50 d.

The electrolytic process in ceramic cells is started by short-circuit heating. The cells are filled with anhydrous rare-earth chlorides and short-circuited with an iron or carbon rod. If molten electrolyte from other cells is available, mischmetal lumps are placed in the melting pots and covered with melt. Electrolysis can be started immediately. The ceramic cells operate continuously. Anhydrous rare-earth chlorides are added as required.

Between metal at the bottom of the cell and the electrolyte is built up a diaphragm of rare-earth oxide chlorides, which operates as an

electrical resistance, generating the heat that keeps the deposited metal in liquid form.

One or two times a day, molten mischmetal is tapped, sucked, or ladled from the bottom of the crucible.

During the process the anode is consumed by oxidation. For this reason, the electrode must be adjusted from time to time. Oxidation results from contact with atmospheric oxygen or the chlorine produced or from reaction with oxide chlorides in the electrolyte. Therefore, a high oxide chloride content in the rare-earth chlorides causes considerable anode consumption.

The amount of molten electrolyte increases during operation. Enrichment of europium and samarium takes place. To maintain a constant level of electrolyte, a part, the so-called slag, is ladled out at regular intervals. This slag can be treated chemically to recover  $\text{Eu}_2\text{O}_3$  and  $\text{Sm}_2\text{O}_3$ . A typical composition of slag is presented in Table 45.2.

**Table 45.2:** Analyses of mischmetal slag, Treibacher Chemische Werke AG, Austria.

Element, as oxide	Relative content, % <sup>a</sup>
$\text{La}_2\text{O}_3$	26.6
$\text{CeO}_2$	31.9
$\text{Pr}_6\text{O}_{11}$	4.1
$\text{Nd}_2\text{O}_3$	19.8
$\text{Sm}_2\text{O}_3$	14.3
$\text{Eu}_2\text{O}_3$	0.4
Total	97.1
Total rare-earth oxide content is 41.9%.	

<sup>a</sup> The element oxide content divided by total rare-earth oxide content.

### 45.2.2.3 Oxide Process

On the basis of a process developed by the U.S. Bureau of Mines [22, 23] and further improved by Santoku Metal Industries, Japan, Santoku now produces mischmetal from rare-earth oxides. The process is similar to aluminum electrolysis (Hall-Héroult process). It avoids emission of chlorine and the consequent expensive purification of off-gas.

Rare-earth oxides are dissolved in an electrolyte consisting of alkali fluorides (to improve conductivity), alkaline-earth fluorides (to reduce melting point), and rare-earth fluo-

rides (to improve the solubility of rare-earth oxides) and are reduced electrolytically to the rare-earth metals. The electrolysis cell (Figure 45.3) consists of a graphite crucible with graphite anode and molybdenum cathode, working under an inert-gas atmosphere to prevent oxidation of the construction materials. The electrolyte is initially melted by resistance heating. Electrolyte and electrodeposited rare-earth metals are kept liquid by the joule heat. A cell produces ca. 500 kg of metal per day. If bastnæsite is a raw material, it must be specially purified prior to electrolysis.

### 45.2.3 Properties

Table 45.3 shows typical analyses of mischmetal from various producers.

The physical and chemical properties of mischmetal are determined by the properties of its four main constituents—cerium, lanthanum, neodymium, and praseodymium [1, 24]. There can be no exact values for mischmetal because the composition depends on the type of raw material and treatment. However, the values correspond most closely to those of the main constituent, cerium. Table 45.4 lists several properties for the four main rare-earth metals.

Mischmetal is ductile. The freshly cut surface has a metallic gray appearance. In air, the

surface oxidizes to form yellow to greenish-gray rare-earth hydroxide carbonates or oxide hydrates. Some types of oil may protect the surface against corrosion, but only for a limited period of time. Alloying with 1–2% of magnesium increases corrosion resistance. Massive metal burns above 150 °C in pure oxygen; however, chips, turnings, and powder burn at this temperature even in air. Mischmetal dissolves in dilute mineral acids with evolution of hydrogen.

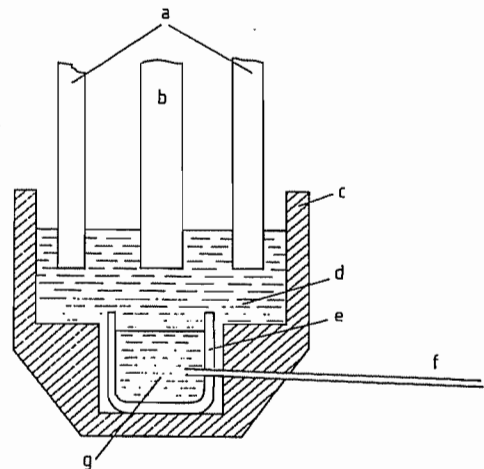

Figure 45.3: Electrolysis cell for the production of mischmetal from oxides [23]: a) Graphite anodes; b) Molybdenum cathode; c) Graphite crucible; d) Liquid electrolyte; e) Molybdenum crucible; f) Tapping pipe; g) Molten mischmetal.

Table 45.3: Typical analyses of mischmetal from various producers, weight percent unless otherwise specified.

Metal	Producer						
	Treibacher (Austria)	Ronson (United States)	Santoku (Japan)	Corona (Brazil)	Fluminense (Brazil)	Former USSR	Minmetals (China)
Total rare-earth metals	99.5	>95	97.8	97.4	96.0	97	98.6
Relative content <sup>a</sup>		18–28					
La	23	50–55	22.9	17.5	17.9	25.1	19.6
Ce	49.8	4–6	51.9	54.2	55.3	53.2	54.9
Pr	5.6	12–18	5.4	5.6	7.3	5.2	6.1
Nd	18.6	<0.1	16.2	16.0	17.4	14.0	17.1
Sm	0.2	<2					0.4
Others	2.8		3.6	6.7	4.8	2.8	1.9
Al	0.05		0.14			0.05	0.1
Pb	50 ppm		343 ppm		90 ppm	227 ppm	4600 ppm
Fe	0.05	<5	1	2.0	2.3	1.7	0.28
Si	0.20			0.1	0.54	0.1	0.05
Mg	0.03	<0.5	0.20	0.20	0.2	0.033	0.35
Ca		<0.1		0.02	0.1		0.013

<sup>a</sup>The content of rare-earth metal divided by total rare-earth metals.

Table 45.4: Properties of lanthanum, cerium, praseodymium, and neodymium [1, 2, 4].

Property	Unit	La	Ce	Pr	Nd
Atomic number <i>z</i>		57	58	59	60
Atomic mass <i>A<sub>r</sub></i>		138.9055	140.115	140.90765	144.24
Crystal structure at 293 K		dhcp <sup>a</sup>	fcc	dhcp <sup>a</sup>	dhcp <sup>a</sup>
<i>a</i> <sub>0</sub>	nm	0.3774	0.51612	0.36725	0.36579
<i>c</i> <sub>0</sub>	nm	1.2159		1.18354	1.17992
Density $\rho$	g/cm <sup>3</sup>	6.146	6.770	6.773	7.008
Melting point <i>mp</i>	°C	918	798	931	1021
Heat of fusion $\Delta H$	kJ/mol	6.2	5.5	6.9	7.1
Boiling point <i>bp</i>	°C	3464	3433	3520	3074
Temperature at a vapor pressure of 133 Pa	°C	2208	2174	1968	1741
0.133 Pa		1581	1581	1360	1197
Specific heat at 25 °C	Jmol <sup>-1</sup> K <sup>-1</sup>	26.2	27.0	27.0	27.5
Coefficient of linear thermal expansion at 25 °C	10 <sup>-6</sup> K <sup>-1</sup>	26.2	27.0	27.0	27.5
Thermal conductivity at 27 °C	J s <sup>-1</sup> cm <sup>-1</sup> K <sup>-1</sup>	0.135	0.114	0.125	0.165
Electrical resistivity at 0 °C	$\mu\Omega$ cm	61	77	71	64

<sup>a</sup>Double hexagonal closest packed in the direction of the *c* axis.

The ingots may be easily machined. However, the pyrophoric character of mischmetal may cause autoignition of the turnings. Mischmetal may be easily extruded at temperatures just below its melting point. Rollability is adversely effected by oxygen content. Nearly all of the alloying elements cause brittleness.

### 45.2.4 Uses

The most important uses of mischmetal or cerium are metallurgical. The metallurgical importance of rare-earth metals is based on reactions to form solids with oxygen, hydrogen, nitrogen, sulfur, arsenic, bismuth, and antimony, reducing the effects of these elements on the properties of the metals [25]. To avoid the formation of harmful rare-earth oxide inclusions by secondary reactions of the mischmetal with refractories, slag, and atmospheric oxygen, the mischmetal is plunged into the molten metal or added under an inert-gas atmosphere. Metallurgical mischmetal can also be clad with aluminum or steel. Mischmetal is added as lumps, rods, doughnuts, or wire [26].

**Iron and Steel** [27]. Rare-earth sulfides and oxide sulfides are formed in liquid steel and precipitate as globular particles uniformly dispersed, which, unlike manganese sulfides, are not deformable during rolling and do not form stringers. This is called sulfide shape control and is used in microalloyed or HSLA (high-

strength low-alloy) steels to reduce anisotropy in toughness, notch toughness, and bend formability. This is especially important for pipeline steels used at subzero temperature in the Arctic.

Mischmetal may entrap hydrogen and diminish hydrogen-induced cracking.

Hot shortness in stainless steels can be reduced by removal of tramp elements (As, Bi, Sb) together with deoxidation and sulfide shape control. Heat and oxidation resistance can be increased by mischmetal, which forms protective surface layers of rare-earth oxides together with oxides of the steel components, for example, Cr<sub>2</sub>O<sub>3</sub>, that are resistant to scaling.

Mischmetal or cerium-containing master alloys are added to cast iron to improve ductility, toughness, and the microstructure. Cerium allows graphite to form nodules, causing nucleation in spheroidal and vermicular cast iron, and neutralizes the harmful effect of the tramp elements [28].

The addition rate depends on the application and preparation of the steel or iron melt. For sulfide shape control and nodularization of graphite, up to 1 kg of mischmetal is added per tonne. Other effects require even larger additions, up to 8 kg per tonne.

**Nonferrous Metals** [29]. Addition of mischmetal to copper alloys improves tensile

strength and deep-drawing properties. The heat resistance and ductility of aluminum conductor cables are improved without any significant decrease in electrical conductivity. Titanium alloys show a higher grade of grain refinement, better mechanical properties, and improved corrosion resistance as a result of mischmetal additions.

The need for improved galvanizing compositions (increased corrosion resistance, fluidity, wettability, and freedom from intergranular corrosion) without affecting formability, weldability, and paintability led to the development of Galfan, which is the classical zinc-aluminum eutectic alloy (95% Zn, 5% Al) with 0.05% mischmetal [30].

In nickel- and cobalt-based superalloys for turbine engines, cerium (yttrium is even better) increases oxidation and sulfidation resistance at high temperature. Similar effects are achieved in chromium-based alloys, and by removing gases cerium prevents embrittlement of niobium- and tantalum-based alloys.

**Other Uses.** Cerium and mischmetal are used as getters to absorb traces of gases in evacuated devices.

Mischmetal is said to increase the efficiency of fuel consumption and to decrease CO and NOX contents in the exhaust of internal combustion engines if steam is passed through mischmetal spirals before injection into the carburetor [31].

In some of these uses, mischmetal (= MM) can be replaced by CeSi, MMSi, or MMFeSi alloys produced directly from bastnæsite by reduction in an arc furnace.

The pyrophoric character of mischmetal alloyed with iron and magnesium is used for flints and pyrotechnics.

## 45.3 Alloys

The atomic radii of lanthanum, cerium, praseodymium, and neodymium differ only slightly so that miscibility is complete in the liquid state and close to the solidus curve. The liquidus curves correspond to those of ideal mixtures.

In the molten state the main constituents of mischmetal are completely miscible with nearly all non-rare-earth metals. Their large atomic radii and their low electronegativities are the reasons why there are only a few cases of their solid solubility in other metals. One such case, however, is the limited solid solubility of mischmetal in magnesium [32]. As solids they do not dissolve other metals; instead, they form intermetallic phases. With elements of the groups 4, 5, and 6 they do not form intermetallic phases [32, 33].

The intermetallic phases, with a degree of heteropolar bonding, may be brittle. Therefore, rare-earth metals and alloys are unsuitable as construction materials. Cerium phase diagrams are generally used in place of mischmetal phase diagrams [32, 34, 35].

Depending on the purity desired, alloying is done in crucibles made of tantalum, molybdenum, boron nitride, graphite, or clay graphite. An inert-gas atmosphere, vacuum, or inert slag cover are necessary.

### 45.3.1 Flint Alloy

Table 45.5: Analyses of lighter flints of different producers, %.

Metal	Producer			
	Treibacher (Austria)	Santoku (Japan)	Électro Centre (France)	Ronson (United States)
Total RE metals	76.2	78.3	76.7	77.0
Relative content*				
Ce	51	52.3	53.3	51.5
La	22.7	24.7	19.2	23.1
Nd	16.6	14.3	16.5	16.5
Pr	5.4	5.0	6.4	5.8
Sm	0.3	0.4	0.4	0.3
Fe	20.6	19.3	20.4	20.0
Mg	2.2	1.8	2.1	1.5
Al	0.09	0.28	0.04	0.05
Cu		0.02	0.03	
Si	0.22	0.29	0.22	0.2
Zn	0.54	0.03	0.34	0.5
C	0.02	0.08	0.06	0.01

\*The content of rare-earth metal divided by total rare-earth metals.

**Pyrophoric Properties.** None of the numerous developments of cerium-free pyrophoric alloys of the last decades has been able to re-

place the cerium-iron alloy invented and patented by AUER VON WELSBACH in 1903. Lighter flint alloy consists basically of mischmetal and iron. Some other metals are added in small amounts to modify the pyrophoric properties and to improve processing. Typical analyses of lighter flint alloys are shown in Table 45.5.

The frictional pyrophoric properties of cerium-iron are based on a combination of microstructure and mechanical and chemical properties of the alloy. The typical crystal structure of commercial alloy consists of tough, brittle primary crystals of  $Ce_2Fe_{17}$  enclosed by a peritectic layer of  $CeFe_2$  embedded in a soft matrix of  $CeFe_2$  and Ce.

Mechanical friction generates primary cracks in the intermetallic compound, initially leading small particles with adherent matrix to break away. Residual frictional and deformation heat in the small particles heats them adiabatically to ignition temperature. On ignition, these particles burn totally. Heat is emitted predominantly by radiation, particle temperature reaching ca. 2000 °C. The size of these particles, which depends on the hardness of the lighter flint, influences the ignition behavior. Smaller particles ignite rapidly, resulting in quick adiabatic heating, whereas larger particles emit a higher local output of reaction heat.

Magnesium and cerium form an intermetallic compound that ensures a high heat of combustion. The temperature of the spark is also increased by alloying with aluminum, which in addition produces a spiky spark. Zinc and copper improve fluidity during extrusion.

**Manufacture of Lighter Flints.** Lighter flint alloy is produced by melting mischmetal, iron, and the other metals in clay graphite or other suitable crucibles heated in induction furnaces at 1000–1200 °C under a protective salt layer ( $CaCl_2$ ,  $BaCl_2$ ). After removal of the salt layer, the alloy is cast into preheated molds.

For better shape control of the  $CeFe_2$  crystallites, the melt is cooled slowly. The as-cast products are billets of 3–6 cm diameter. Average yield of alloy, based on raw material input,

is 95–98%. Losses arise from air oxidation and reaction with the crucible material.

After preheating at 400–500 °C, the flint billets are extruded to rods on horizontal or vertical extrusion presses at pressures between 20 and 50 MPa. Alloying with aluminum, magnesium, zirconium, titanium, and copper lowers the amount of pressure required. Extrusion pressure is also affected by impurities in the mischmetal, the rare-earth distribution, and the iron content of the alloy. During extrusion, the eutectic matrix liquefies. After extrusion, the rods are cooled rapidly in air or cooling oil. The diameter of the rods usually ranges between 2 and 6 mm.

These rods are cut on horizontal or vertical dies to the length of the lighter flint, usually between 4 and 12 mm. A subsequent heat treatment between 350 and 450 °C improves the pyrophoric properties considerably [36] by conversion of Ce-Fe mixed crystals, formed through rapid solidification during extrusion, into  $CeFe_2$  and Ce.

The lighter flints are sized on sorting machines, generally with sorting sieves. These mechanically presorted flints are checked carefully by mechanical and optical sorting machines. Some producers make a final inspection by eye: flints are moved over a conveyor belt and imperfect flints are picked out by hand. Flints are checked for length, diameter, and straightness, as well as to see if the area of cut is circular as desired and if cavities or burrs are absent from the cut surface.

Durability of lighter flints is limited to 4–5 years normally. Humid air and a warm climate, such as prevails in the tropics, cause quick decomposition of the flint, visible as a dusting at the beginning of the decomposition process. For protection of the flint surface against corrosion, flints are normally coated and colored with lacquer.

Generally, there is a distinction between the normal lighter flints (most commonly 2.4 mm in diameter and 4 mm in length) and the lighter flints for disposable lighters. Flints for disposable lighters are manufactured in a length from 7 to 12 mm and a diameter from 2.3 to 2.5 mm, depending on the amount of

gas filling in the lighter. Such flints should ignite at least 1000 times before 50% of the flint is used up.

Accuracy of size is important for flints for disposable lighters because filling is carried out by machines and each faulty flint stops production. Maximum tolerances of  $\pm 0.1$  mm in length and in diameter are acceptable. One kilogram of lighter flints contains from 3000 to 10 000 flints.

### 45.3.2 Permanent Magnets

The classic  $\text{RECo}_5$  permanent magnet alloys are based on samarium, which gives the best hard magnetic properties. Replacement of samarium, an expensive rare-earth metal, by cerium or even by inexpensive mischmetal reduces the hard magnetic properties, especially because of the lower crystal anisotropy field [37]. However, adding small amounts of samarium to the mischmetal and/or changing the composition of the mischmetal [38] or partial replacement of cobalt [39, 40] makes magnets with sufficient coercivity and energy product for less sophisticated uses and increases the range of uses because of the lower costs.

These alloys are manufactured by melting the metals or by calcinothermic reduction of oxide and metal-powder mixtures [41].

These magnets are used for electronic watches, microwave amplifier tubes, loudspeakers, headphones and microphones, magnetic coupling, bearings, sensors, clamp systems, switches, d.c. motors, servomotors, and step motors, mainly to achieve miniaturization.

Some magnetic properties are listed in Table 45.6.

### 45.3.3 Hydrogen Storage

$\text{LaNi}_5$  has a high storage capacity for hydrogen gas [42], up to the formula  $\text{LaNi}_5\text{H}_{6.7}$ . To decrease costs, lanthanum can be replaced by mischmetal [43]. However, to lower the higher hydrogen equilibrium pressure and form hydrides up to the formula  $\text{MMNi}_5\text{H}_{6.3}$ , the nickel must be partially replaced [44] by

aluminum [45], calcium [46], cobalt [47], chromium [48], copper [49], iron [50], or manganese [51]. Pressure composition isotherms are shown in Figure 45.4. Alloys of the type  $\text{CeMg}_{11}\text{M}$  ( $\text{M} = \text{Ni}, \text{Cu}, \text{Zn}$ ) also absorb hydrogen [52].

These systems may be used for hydrogen transportation and storage; vehicular and stationary fuel supply, an ideal fuel from the ecological point of view; air conditioning; refrigeration; heat pumps; storing and regaining waste heat; and hydrogen-storage electrodes in alkaline batteries. These systems may also be used for purification [53] and isolation [54] of hydrogen and  $\text{H}_2/\text{D}_2$  separation.

Table 45.6: Intrinsic magnetic properties of  $\text{RECo}_5$  compounds at room temperature [40].

Property	$\text{SmCo}_5$	$\text{CeCo}_5$	$\text{MMCo}_5^a$
Saturation magnetization $B_p$ , T	1.07	0.77	0.89
Anisotropy constant $K$ , $10^6 \text{ Jm}^{-3}$	9.6	5.6	6.6
Anisotropy field $H_A$ , MA/m	20	15.1	14.7
Curie temperature $T_c$ , °C	724	347	520
Theoretical energy product $B_p^2/4$ , $\text{kJm}^{-3}$	228	118	158

\* The values for  $\text{MMCo}_5$  are only approximate, for composition varies.

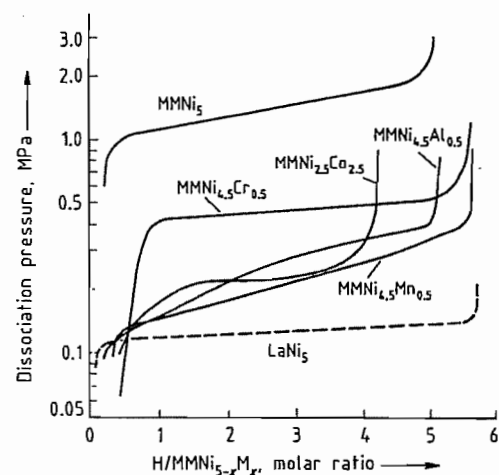

Figure 45.4: Pressure-composition isotherms for desorption in the  $\text{LaNi}_5\text{-H}$ ,  $\text{MMNi}_5\text{-H}$ , and modified  $\text{MMNi}_{5-x}\text{M}_x\text{-H}$  systems at 293 K [44]. MM represents mischmetal, and M represents a metal (here Al, Co, Cr, or Mn).

## 45.4 Compounds

Cerium is the most abundant rare-earth element. Nearly 50% of the available rare-earth raw material consists of cerium oxide. Cerium is also the only rare-earth element that can be easily separated from a mixture of rare-earth elements by simple chemical methods, for cerium has a tetravalent state.

### 45.4.1 Production

Cerium is separated from other rare-earth elements by oxidation of solutions resulting from attack of bastnaesite or monazite. The oxidizing agent can be  $\text{H}_2\text{O}_2$ , hypochlorite, or atmospheric oxygen, or anodic oxidation can be used. Cerium precipitates as cerium(IV) oxide hydrate.

For example, cerium(III) rare-earth oxide hydrate is dried and oxidized by air to cerium(IV) rare-earth oxide hydrate. The oxidized hydrate is dissolved in nitric acid, and the solutions are neutralized slowly. Cerium(IV) oxide hydrate is collected by filtration. Initially, of the total rare-earth oxides 45–50% is  $\text{CeO}_2$ . This is increased to 95% in the product.

In a process of Molycorp [55], ground bastnaesite ore concentrates are roasted, and cerium is oxidized with atmospheric oxygen. Roasted material is treated with hydrochloric acid to dissolve lanthanum, neodymium, praseodymium, etc. The pH is adjusted to 4, and a cerium-rich residue ( $\approx 90\% \text{CeO}_2$ ) is collected by filtration. This residue has high fluoride content and poor solubility. To get soluble cerium salts out of this material a subsequent digestion with sulfuric acid or caustic soda is necessary.

Cerium salts are produced today by liquid-liquid extraction from rare-earth cerium-containing solutions. Cerium can be extracted out of cerium nitrate-nitric acid solutions in a few steps in the form of a cerium(IV) nitrate complex in tributyl phosphate and therefore separated from the accompanying trivalent rare-earth elements, which form less stable nitrate

complexes. Purities of 99.99% and better can be achieved easily.

### 45.4.2 Uses

The principal uses for cerium compounds are as polishing agents and as a component in glass.

**Cerium Oxide Polishing Compounds.** Cerium(IV) oxide,  $\text{CeO}_2$ , has now replaced other polishing oxides like iron oxide (red rouge), silica (white rouge), and zirconium dioxide almost completely. The special merits of cerium oxide are its 100% faster polishing speed and its cleanliness.

Cerium oxide is used for polishing glass mirrors, plate glass, television tubes, ophthalmic lenses, and precision optics. However, the advent of the Pilkington float process in the early 1970s significantly reduced the use of cerium oxide in the manufacture of plate glass.

Cerium oxide polishing powder is produced by calcining oxidic cerium mineral concentrates in rotary kilns or other furnaces at temperatures of ca. 1000 °C. Calcined concentrates are milled and cleaned by sieving or sifting afterwards. The impurities ( $\text{CaO}$ ,  $\text{SrO}$ , non-rare-earth elements) must not exceed a certain level in the raw material; otherwise, cerium oxide will agglomerate during calcining and lose polishing capacity.

Polishing powders production can also start from cerium salt solutions. Cerium carbonates or hydroxides are precipitated and then calcined in rotary kilns or muffle furnaces to oxide at temperatures of ca. 1000 °C. The calcined oxides are milled and screened or sifted to get the desired grain size distribution and to remove scratching impurities.

Polishing powders made from mineral concentrates polish more slowly and less cleanly than precipitated products. The former are cheaper but are not used for high-performance polishing processes (precision optics).

Additives improve suspension properties of polishing powders in aqueous solutions and increase polishing rate, for instance, prevent-

ing foaming (antifoaming) and settling of cerium oxide (anticaking) in tanks and pipes.

Pure cerium oxide is yellowish white. Small amounts of  $\text{Pr}_6\text{O}_{11}$  in combination with other rare-earth oxides give a brown oxide. The color does not appear to affect the polishing properties for fixed  $\text{CeO}_2$  content. Currently, standard concentrations are 50, 70, 90, and 100%. The polishing rate increases with  $\text{CeO}_2$  content. The average grain size of polishing powders is normally 0.5–5  $\mu\text{m}$ . A narrow grain size distribution is advantageous.

There are many theories about the mechanism of the polishing process [56]. According to these theories, both a chemical and a physical component, among others, are effective during polishing [57]. The glass surface is hydrolyzed by reaction with water (chemical theory) and the silica gel layer formed is removed mechanically by the polishing compound. Another theory states that glass is removed mechanically (wear theory) and to some extent by chemical reaction [58].

**Cerium Oxide as a Glass Constituent.** Cerium oxide can be used to decolorize soda lime glasses for bottles, jars, etc. [59]. The  $\text{Ce}^{4+}$  oxidizes  $\text{Fe}^{2+}$  impurities, which are always present in the raw materials and therefore in glasses, to  $\text{Fe}^{3+}$ . A change from the blue-green color of  $\text{Fe}^{2+}$  to the 10 times weaker yellow  $\text{Fe}^{3+}$  takes place. Arsenic, zinc selenite, or manganese are used for the same purpose. The combination of these materials with cerium reduces costs. Presently, cerium oxide has been replaced by less expensive decolorizers.

Cerium protects glass against solarization and browning, a discoloration caused by irradiation. It is therefore a constituent of glass for the faceplates of television screens, which are under constant bombardment by an electron beam [60]. Radiation-shielding windows for nuclear and radiochemical uses consist of lead glass stabilized by  $\text{CeO}_2$ . Since maximum transmission is necessary for these thick windows, only 99.99% cerium oxide (15 ppm Fe max.) can be used.

For phototropic glasses, as in phototropic eye glasses, windshields, and window glasses

that darken in the sunlight and lighten in the shade, cerium is a sensitizer.

**Other Uses.** Cerium rare-earth fluorides improve the brightness of carbon arcs. Cerium fluoride oxide mixtures are mixed with carbon for electrodes. These electrodes are used on movie sets and as military searchlights to increase brightness as much as tenfold [61]. Cerium oxide (99.9%) is used as white pigment in enamels for tiles.

Basic oil-soluble cerium salts of organic acids, such as cerium alkyl sulfonates, alkyl sulfates, and alkyl phosphates, as well as cerium octoates, serve as driers in paints and varnishes. Cerium compounds that are soluble in organic liquids find use as combustion additives in fuels [62]. Particle emission in exhaust gases is reduced by 60%. Diesel oil savings in the range 2–3% are achieved. Cerium compounds added to silicones increase the thermal stability.

Cerium oxide is used in self-cleaning ovens as a catalyst [63].

In zeolitic cracking catalysts, cerium is a thermal and hydrothermal stabilizer to extend the life and increase the activity of the catalysts [64]. The following uses of cerium in noncracking catalysts are listed by PETERS and KIM [65]:

- Ammonia synthesis
- Hydrogenation
- Dehydrogenation
- Polymerization
- Isomerization
- Oxidation
- Automobile emissions control

## 45.5 Analysis

Mischmetal and cerium oxide can be analyzed for total rare-earth content and for individual rare-earth elements [6, 66].

The determination of the *total rare-earth content* is carried out by dissolving the rare-earth-containing material with acids or by alkaline fusion. The rare-earth elements are precipitated as hydroxides by adding  $\text{NH}_3$ ,

dissolved in  $\text{HCl}$  or  $\text{HNO}_3$ , and reprecipitated as oxalates, which are ignited to the oxides,  $\text{RE}_2\text{O}_3$ , with the exception of cerium, which forms  $\text{CeO}_2$ .

The individual rare-earth elements are determined by X-ray fluorescence (La), atomic absorption spectrometry (Y), and spectrophotometry (Nd, Pr, Sm). Analysis by means of optical plasma emission spectroscopy is a new, efficient method. Cerium can be determined by titration because it can be oxidized to the tetrapositive state.

## 45.6 Economic Aspects

Total rare-earth production in the Western world is 20 000–25 000 t of rare-earth oxides per year, of which 45–50% is cerium. Raw material prices have stabilized for bastnæsité at \$1 per pound total rare-earth oxide FAS Los Angeles, for monazite at A\$450 per tonne FOB Australia, and rare-earth chlorides ( $\text{RECl}_3 \cdot 6\text{H}_2\text{O}$ ) at ca. \$0.70 per pound delivered.

The growing production of rare-earth raw material and products from China should only stabilize the market and not sensationally affect prices.

Rhône-Poulenc (France, compounds) and Molycorp-Union Oil (United States, bastnæsité and compounds) are the leading producers; other producers are Treibacher (Austria, metals, alloys, and compounds), Santoku (Japan, metals, alloys, and compounds), Ronson and Reactive Metals (United States, metals and alloys), Indian Rare Earths (India, compounds), and Corona and Fluminense (Brazil, metals and alloys). In Germany, Goldschmidt specializes in magnet alloys. Further magnet alloy producers are Hitachi and Research Chemicals (United States) and Sumitomo and Shin-Etsu (Japan).

Important producers of lighter flints in the Western world are Treibacher, Electro Centre (France), Santoku, and Ronson. Total world market for lighter flints is estimated at ca. 700 t/a. The share of flints for disposable lighters is more than 60%.

Modern steel technology has decreased demand for mischmetal substantially. The metallurgical uses of rare-earth metals consume less than 15% of the total rare-earth production. The production capacity for mischmetal is 4000–5000 t/a, but less than 50% is in operation. Mischmetal is sold at \$45 per pound, depending on quantity, shape, and size.

Total world demand for cerium-based polishing powders, the biggest consumer of cerium oxide at present, is estimated to be 3000–4000 t/a. The price for cerium polishing compounds depends on the cerium content and ranges between \$2 per pound for 50%  $\text{CeO}_2$  and \$5 per pound for 99.9%  $\text{CeO}_2$ .

The market for more sophisticated uses—electronics, magnets, etc.—is expected to grow.

The production of rare earths is profitable only if the market for all the rare-earth elements, which are produced in the relative amounts occurring in their minerals, is reasonably balanced.

## 45.7 Toxicology and Occupational Health

The rare-earth elements and compounds are considered to be only slightly toxic. No toxic effects during production or use have been reported in the rare-earth industry.

Progressive lung retention was observed after inhalation of dust containing rare-earth oxides and fluorides from carbon arc electrodes. The damage to the lung that was assessed by X ray did not seem to be attributable to the rare earths, but to thorium and its disintegration products. Continual progress in rare-earth processing has reduced the radioactive impurities in rare-earth products substantially, so they are practically free of radioactivity today. Intravenous injections of rare-earth salts damage the liver; oral administration has no pathological effect on animals [1, B2, pp. 282–283; 67].



## 45.8 References

1. Gmelin, system no. 39, Seltene Erden, A1 (1938); A2-A5, A7, A8, B1-B7, C1-C9, D1-D6 (1973 to date).
2. K. A. Gscheidner, Jr., L. Eyring (eds.): *Handbook on the Physics and Chemistry of Rare Earths*, vol. 1 (1978), vols. 2-4 (1979); vol. 5 (1982), vols. 6 and 7 (1984), vol. 8 (1986), North Holland Publ., Amsterdam.
3. L. Eyring (ed.): *Progress in the Science and Technology of the Rare Earths*, vol. 1 (1964), vol. 2 (1966), vol. 3 (1968), Pergamon Press, Oxford.
4. J. A. Gibson, G. S. Harvey: *Properties of the Rare Earth Metals and Compounds*, Technical Report AFML-TR-65-430, 1966.
5. F. H. Spedding, A. H. Daane: *The Rare Earths*, J. Wiley & Sons, New York 1961.
6. F. Trombe, J. Loriers, P. Gaume-Mahn, C. Henry La Blanchetais: "Scandium-Yttrium-Éléments des terres rares-Actinium", in P. Pascal (ed.): *Nouveau Traité de chimie minérale*, vol. VII, Fascicules 1 + 2, Masson, Paris 1959.
7. J. Helgorsky, A. Lévêque, T. Petzel, K. Reinhardt: "Seltene Erden", in *Ullmann*, 4th ed., 21, 235-271.
8. E. Greinacher, K. Reinhardt: "Seltene Erden", in *Winnacker-Küchler*, 4th ed., vol. 2, pp. 678-707.
9. K. A. Gscheidner, Jr. (ed.): *Industrial Application of Rare Earth Elements*, ACS Ser. no. 164, Washington, DC, 1981.
10. I. H. Jolly, R. P. Smith: "Availability of Rare Earths to Industry", in *Proc. Rare Earth Res. Conf.*, 12th, 1976.
11. C. R. Neary, D. E. Highley: "The Economic Importance of the Rare Earth Elements", *Dev. Geochem.* 2 (1984) 423-466.
12. J. Griffiths, *Ind. Min. (London)* 199 (1984) April, 19-37.
13. Soc. prod. chim. terres rares, FR 995112, 1949 (C. de Rhoden, M. Peltier).
14. A. E. Bearse, G. D. Calkins, J. W. Glegg, R. B. Filbert, *Chem. Eng. Prog.* 50 (1954) 235-239.
15. P. R. Kruesi, G. Duker, *J. Met.* 17 (1965) 847-849.
16. D. J. Bauer, V. E. Shaw, *Rep. Invest. U.S. Bur. Mines* no. 6381, Washington, DC, 1964.
17. W. Brugger, E. Greinacher, *J. Met.* 19 (1967) 32-35; Th. Goldschmidt AG, DE 956993, 1954 (W. Brugger).
18. I. S. Hirschhorn, *J. Met.* 20 (1968) 19-22. BIOS Final Rep. no. 22 (file no. XXXIII-31), 1947, p. 133.
19. BIOS Final Rep. no. 400 (item no. 21), 1945, p. 36.
20. D. Tang, R. Song, S. Du, M. Zao, Y. Minshou, W. Yu, *Proc. Int. Symp. Molten Salt Chem. Technol.*, 1st, 1983, 103-106.
21. Th. Goldschmidt AG, DE 2254245, 1974 (E. Greinacher).
22. T. A. Henrie, *J. Met.* 16 (1964) 978-981.
23. E. S. Shedd, J. D. Marchant, M. M. Wong, *Rep. Invest. U.S. Bur. Mines* no. 7398, Washington, DC, 1970.
24. B. J. Beaudry, K. A. Gscheidner, Jr. in [2], vol. 1, pp. 173-232.  
D. C. Koskenmaki, K. A. Gscheidner, Jr. in [2], vol. 1, pp. 337-378.
25. K. A. Gscheidner, Jr., N. Kippenhan: *Thermochemistry of the Rare Earth Carbides, Nitrides, and Sulfides*, IS-RIC-5, Rare Earth Information Center, Iowa State University, Ames, IA, 1972.  
K. A. Gscheidner, Jr., N. Kippenhan, O. D. McMasters: *Thermochemistry of the Rare Earths*, IS-RIC-6, Rare Earth Information Center, Iowa State University, Ames, IA, 1973.
26. K. Reinhardt: "Addition Techniques of Rare Earth Metals for the Treatment of Special Steels with Rare Earths", in *Proc. Rare Earth Res. Conf.*, 12th, 1976.
27. A. Raman, *Z. Metallkd.* 67 (1976) 780-789.  
L. A. Luyckx: "The Rare Earth Metals in Steel", pp. 43-78 in [9].
28. B. Zao, E. W. Langer, *Scand. J. Metall.* 13 (1984) no. 1, 15-22, 23-31.  
H. F. Linebarger, T. K. McLuhan: "The Role of the Rare Earth Elements in the Production of Nodular Iron", pp. 19-42 in [9].
29. A. Raman, *Z. Metallkd.* 68 (1977) 163-172.
30. S. F. Radtke, D. C. Herrschaft, *J. Less-Common Met.* 93 (1983) 253-259.  
F. E. Goodwin, S. F. Radtke: *Galvanizing Alloy and Technology*, 2nd ed., Int. Lead and Zinc Res. Org., ILZRO, New York 1983.
31. Manassa, DE-OS 2551350, 1975.
32. K. A. Gscheidner, Jr.: *Rare Earth Alloys*, Van Nostrand, Princeton-London 1961.
33. H. R. Kirchmayr, *Z. Metallkd.* 60 (1969) 699-708, 778-784.  
W. E. Wallace: *Rare Earth Intermetallics*, Academic Press, New York-London 1973.
34. K. H. J. Buschow, *Rep. Prog. Phys.* 42 (1979) 1373-1477.  
M. Hansen, K. Anderko: *Constitution of Binary Alloys*, 2nd ed., McGraw-Hill, New York 1958.  
R. P. Elliot: *Constitution of Binary Alloys*, First Supplement, 1965.  
T. A. Shunk: *Constitution of Binary Alloys*, Second Supplement, 1969.  
W. G. Moffatt: *The Handbook of Binary Phase Diagrams*, General Electric, Schenectady, NY, 1978.  
K. A. Gscheidner, Jr., F. W. Calderwood: *Critical Evaluation of Binary Rare Earth Phase Diagrams*, ISRIC-PR 1-10 (to be continued), Rare Earth Information Center, Iowa State University, Ames, IA, 1981 on.
35. K. A. Gscheidner, Jr., M. E. Verkade: *Selected Cerium Phase Diagrams*, IS-RIC-7, Rare Earth Information Center, Iowa State University, Ames, IA, 1974.
36. Treibacher Chemische Werke AG, AT 342323, 1977 (H. Zeiringer).
37. H. R. Kirchmayr, C. A. Poldy in [2], vol. 2, pp. 55-230, especially pp. 197-230.  
*Proc. Int. Workshop Rare Earth-Cobalt Perm. Magnets Their Appl.*, 5th, 1981.  
*Proc. Int. Workshop Rare Earth-Cobalt Perm. Magnets Their Appl.*, 6th, 1982.  
*Proc. Int. Symp. Magn. Anisotropy Coercivity in Rare Earth-Transition Met. Alloys*, 3rd, 1982.  
*Proc. Int. Workshop Rare Earth-Cobalt Perm. Magnets Their Appl.*, 7th, 1983.
38. K. Bachmann, *J. Magn. Magn. Mater.* 4 (1977) 8-12.  
Ugimag Recoma AG, DE 2449361, 1976 (S. Gaiffi, A. Menth, H. Nagel).  
Ugimag Recoma AG, DE 2543916, 1977 (S. Gaiffi, A. Menth, H. Nagel).
39. G. Schäfer, H. H. Wiegand, *Metall (Berlin)* 29 (1975) no. 2, 113-121.  
J. W. Walkiewicz, E. Morrice, M. M. Wong, *IEEE Trans. Magn. MAG-19* (1983) 2053-2055.
40. M. G. H. Wells, K. S. V. L. Narasimhan: "Developments in Mischmetal-Cobalt, and Low-Samarium Magnet Materials", *"Goldschmidt informiert..."* no. 48 (1979) pp. 15-22.
41. Th. Goldschmidt AG, DE 2303697, 1974 (H.-G. Domazer).
42. E. L. Huston, J. J. Sheridan III: "Applications for Rechargeable Metal Hydrides", pp. 223-250 in [9].  
K. H. J. Buschow in [2], vol. 6, pp. 1-111.
43. J. Liu, E. L. Huston, *J. Less-Common Met.* 90 (1983) 11-20.
44. Y. Osumi, H. Suzuki, A. Kato, K. Oguro, M. Nakane, *J. Less-Common Met.* 74 (1980) 271-277.
45. G. D. Sandrock, US 4152145, 1979.  
Y. Osumi, A. Kato, H. Suzuki, M. Nakane, Y. Miyake, *J. Less-Common Met.* 66 (1979) 67-75.  
V. K. Sinha, W. E. Wallace, *J. Phys. Chem.* 88 (1984) 102-105.
46. G. D. Sandrock, *Proc. World Conf. Hydrogen Energy Systems*, 2nd, Zürich 1978, vol. 3, pp. 1625-1656.  
International Nickel Co., US 4161402, 1979 (G. D. Sandrock).
47. R. A. Guidotti, G. B. Atkinson, M. M. Wong, *J. Less-Common Met.* 52 (1977) 13-28.  
Agency of Industrial Science and Technology, US 4147536, 1979 (Y. Osumi, H. Suzuki, A. Kato, M. Nakane, Y. Miyake).
48. Agency of Industrial Science and Technology, US 4347082, 1982 (Y. Osumi, H. Suzuki, A. Kato, M. Nakane).  
Y. Osumi, H. Suzuki, A. Kato, K. Oguro, M. Nakane, *J. Less-Common Met.* 79 (1981) 207-214.
49. F. Pourarian, W. E. Wallace, *J. Less-Common Met.* 87 (1982) 275-281.
50. International Nickel Co., US 4249940, 1981 (G. D. Sandrock, S. L. Keresztes).
51. C. E. Lundin, F. E. Lynch, *Altern. Energy Sources Proc. Miami Int. Conf.* 1977, 8 (1978) 3803-3820.
52. B. Darriet, A. Hbika, M. Pezat, *J. Less-Common Met.* 75 (1980) 43-50.
53. Shin-Etsu Chemical, DE-OS 2623213, 1976 (Z. Hagiwara, S. Matsui, S. Sakaguchi, Y. Yamanaka).
54. U.S. Atomic Energy Commission, US 3825418, 1973 (J. J. Reilly, R. H. Wiswall, Jr.).
55. H. W. Harrah: *Deco Trefoil*, Denver Equipment Co., Denver, CO, 1967, p. 9.
56. R. V. Horrigan: "Rare Earth Polishing Compounds", pp. 95-100 in [9].
57. A. Kaller, *Silikattechnik* 31 (1980) 208-214.
58. T. Izumitani, S. Harada, *Wiss. Z. Friedrich-Schiller- Univ., Jena. Math.-Naturwiss. Reihe* 28 (1979) no. 2-3, 389-413.
59. A. P. Herring, R. W. Dean, J. L. Drobnick: "Use of Cerium Concentrate for Decolorizing Soda-Lime Glasses", *Glass Ind.* 51 (1970) 316-322, 350-356, 394-399.
60. L. W. Riker: "The Use of Rare Earths in Glass Compositions", pp. 81-94 in [9].
61. Molycorp-Union Oil: "Cerium", *Overview of Application Information and Possibilities*, no. 58.
62. Gulf Research & Development Co., US 4264335, 1981 (C. Bello, R. J. Hartle, G. M. Singerman).
63. E. I. Du Pont de Nemours & Co., US 3266477, 1966; US 3271322, 1966 (A. B. Stiles).
64. D. N. Wallace: "The Use of Rare Earth Elements in Zeolite Cracking Catalysts", pp. 101-116 in [9].
65. A. W. Peters, G. Kim: "Rare Earths in Noncracking Catalysts", pp. 117-131 in [9].
66. A. Brusdeylins, *Chem. Ztg.* 97 (1973) 343-347.  
O. B. Michelsen (ed.): *Analysis and Application of Rare Earth Materials*, Universitetsforlaget, Oslo 1973.  
Cheng Jai-Kai, *Inorg. Chim. Acta* 94 (1984) 249-258.  
P. Melard: "Quality Control on an Industrial Scale at the LaRochelle Rare Earth Plant", *Rare Earths Mod. Sci. Technol.* 2 (1980) 517-526.
67. T. J. Healey in [2], vol. 4, pp. 553-585.  
P. Arvela: "Toxicity of Rare Earths", *Prog. Pharmacol.* 2 (1979) no. 3, 69-114.